

	Pictorial index	Search by illustration	
1	For safety and security	Make sure to read through them	
2	Instrument cluster	How to read the gauges and meters, the variety of warning lights and indicators, etc.	
3	Operation of each component	Opening and closing the doors and windows, adjustment before driving, etc.	
4	Driving	Operations and advice which are necessary for driving	
5	Interior features	Usage of the interior features, etc.	
6	Maintenance and care	Caring for your vehicle and maintenance procedures	
7	When trouble arises	What to do in case of malfunction or emergency	
8	Vehicle specifications	Vehicle specifications, customizable features, etc.	
9	For owners	Reporting safety defects for U.S. owners, and seat belt, SRS airbag and headlight aim instructions for Canadian owners	
	Index	Search by symptom	
		Search alphabetically	

2 TABLE OF CONTENTS

For your information.....	8
Reading this manual.....	14
How to search.....	15
Pictorial index.....	16

1 For safety and security

1-1. For safe use	
Before driving.....	34
For safety drive.....	36
Seat belts.....	38
SRS airbags.....	44
Front passenger occupant classification system.....	57
Safety information for children.....	63
Child restraint systems.....	64
Installing child restraints.....	68
Exhaust gas precautions.....	77
1-2. Theft deterrent system	
Engine immobilizer system.....	78
Alarm.....	80

2 Instrument cluster

2. Instrument cluster	
Warning lights and indicators.....	84
Gauges and meters.....	89
Multi-information display.....	94
Fuel consumption information.....	102

3 Operation of each component

3-1. Key information	
Keys.....	108
3-2. Opening, closing and locking the doors and trunk	
Smart access system with push-button start.....	113
Wireless remote control.....	129
Doors.....	133
Trunk.....	137
3-3. Adjusting the seats	
Front seats.....	144
Power rear seat.....	150
Driving position memory.....	163
Rear seat position memory.....	168
Head restraints.....	170
3-4. Adjusting the steering wheel and mirrors	
Steering wheel.....	174
Inside rear view mirror.....	175
Outside rear view mirrors.....	177
3-5. Opening, closing the windows and moon roof	
Power windows.....	181
Moon roof.....	185

4 Driving

4-1. Before driving

Driving the vehicle	190
Cargo and luggage.....	201
Vehicle load limits.....	205
Trailer towing	206
Dinghy towing	207

4-2. Driving procedures

Engine (ignition) switch.....	208
Automatic transmission (except 2WD models with paddle shift switches).....	213
Automatic transmission (2WD models with paddle shift switches)	218
Turn signal lever	224
Parking brake	225
Brake Hold	228
Horn	230

4-3. Operating the lights and wipers

Headlight switch	231
Automatic High Beam.....	235
Fog light switch	240
Windshield wipers and washer	241
Headlight cleaner switch.....	245

4-4. Refueling

Opening the fuel tank cap	246
---------------------------------	-----

4-5. Using the driving support systems

Cruise control	250
Dynamic radar cruise control with full-speed range.....	254
LKA (Lane-Keeping Assist).....	271
Driving mode select switch	281
Electronically modulated air suspension.....	284
Driving assist systems	286
PCS (Pre-Collision System)	293
BSM (Blind Spot Monitor)	306
• The Blind Spot Monitor function	310
• The Rear Cross Traffic Alert function	313
Lexus night view	316

4-6. Driving tips

Winter driving tips.....	321
--------------------------	-----

5 Interior features

5-1. Remote Touch screen

Remote Touch 326
 12.3-inch display 330

5-2. Lexus Climate Concierge

Lexus Climate
 Concierge..... 333

5-3. Using the air conditioning system and defogger

Front automatic air conditioning system 334
 Rear air conditioning system..... 352
 Rear window and outside rear view mirror defoggers..... 359
 Windshield wiper de-icer..... 360

5-4. Using the interior lights

Interior lights list 361
 • Interior lights..... 362
 • Personal lights 363

5-5. Using the storage features

List of storage features 365
 • Glove box 367
 • Coin holder 368
 • Door pockets..... 368
 • Cup holders 369
 • Console box 371
 • Cool box/auxiliary box 373
 • Auxiliary boxes 376
 Trunk features..... 379

5-6. Other interior features

Sun visors and vanity mirrors..... 382
 Clock 384
 Ashtrays..... 385
 Cigarette lighters..... 386
 Power outlets..... 388
 Heated steering wheel..... 392
 Climate control seats/
 seat heaters..... 394
 Armrest..... 399
 Retractable table..... 400
 Rear sunshade 402
 Rear door sunshades 406
 Trunk storage extension..... 409
 Coat hooks..... 411
 Assist grips 412
 Garage door opener 413
 LEXUS Enform Safety
 Connect..... 420

6 Maintenance and care

6-1. Maintenance and care

- Cleaning and protecting the vehicle exterior 428
- Cleaning and protecting the vehicle interior 432

6-2. Maintenance

- Maintenance requirements 435
- General maintenance 438
- Emission inspection and maintenance (I/M) programs 442

6-3. Do-it-yourself maintenance

- Do-it-yourself service precautions 443
- Hood 446
- Positioning a floor jack 447
- Engine compartment 449
- Tires 464
- Tire inflation pressure 475
- Wheels 478
- Air conditioning filter 480
- Electronic key battery 483
- Checking and replacing fuses 485
- Headlight aim 489
- Light bulbs 491

7 When trouble arises

7-1. Essential information

- Emergency flashers 494
- If your vehicle has to be stopped in an emergency 495

7-2. Steps to take in an emergency

- If your vehicle needs to be towed 496
- If you think something is wrong 502
- Fuel pump shut off system 503
- If a warning light turns on or a warning buzzer sounds 504
- If a warning message is displayed 514
- If you have a flat tire (vehicles with a spare tire) 518
- If you have a flat tire (vehicles with run-flat tires) 527
- If the engine will not start 529
- If the shift lever cannot be shifted from P 531
- If the parking brake cannot be released 532
- If the electronic key does not operate properly 536
- If the vehicle battery is discharged 539
- If your vehicle overheats 543
- If the vehicle becomes stuck 547

8 Vehicle specifications

8-1. Specifications
 Maintenance data
 (fuel, oil level, etc.)550
 Fuel information.....563
 Tire information.....566

8-2. Customization
 Customizable features577

9 For owners

Reporting safety defects
 for U.S. owners..... 588

Seat belt instructions
 for Canadian owners
 (in French).....589

SRS airbag instructions
 for Canadian owners
 (in French)..... 591

Headlight aim instructions
 for Canadian owners
 (in French).....600

Index

What to do if...
 (Troubleshooting)604
 Alphabetical index610

For information regarding the equipment listed below, refer to “NAVIGATION AND MULTIMEDIA SYSTEM OWNER’S MANUAL”.

- Navigation system
- Audio/visual system
- Rear seat entertainment system
- Intuitive parking assist
- Lexus parking assist monitor

امداد خودرو فارما

تلفن شبانه روزی: ۰۲۱-۸۸۸۶۲۰۸۵

FarmaSOS.com

1

2

3

4

5

6

7

8

9

For your information

Main Owner's Manual

Please note that this manual applies to all models and explains all equipment, including options. Therefore, you may find some explanations for equipment not installed on your vehicle.

All specifications provided in this manual are current at the time of printing. However, because of the Lexus policy of continual product improvement, we reserve the right to make changes at any time without notice.

Depending on specifications, the vehicle shown in the illustrations may differ from your vehicle in terms of color and equipment.

Noise from under vehicle after turning off the engine

Approximately five hours after the engine is turned off, you may hear sound coming from under the vehicle for several minutes. This is the sound of a fuel evaporation leakage check and, it does not indicate a malfunction.

Accessories, spare parts and modification of your Lexus

A wide variety of non-genuine spare parts and accessories for Lexus vehicles are currently available in the market. You should know that Toyota does not warrant these products and is not responsible for their performance, repair, or replacement, or for any damage they may cause to, or adverse effect they may have on, your Lexus vehicle.

This vehicle should not be modified with non-genuine Lexus products. Modification with non-genuine Lexus products could affect its performance, safety or durability, and may even violate governmental regulations. In addition, damage or performance problems resulting from the modification may not be covered under warranty.

Installation of a mobile two-way radio system

The installation of a mobile two-way radio system in your vehicle could affect electronic systems such as:

- Multiport fuel injection system/sequential multiport fuel injection system
- Dynamic radar cruise control with full-speed range
- Cruise control system
- Anti-lock brake system
- Vehicle dynamics integrated management
- SRS airbag system
- Seat belt pretensioner system

Be sure to check with your Lexus dealer for precautionary measures or special instructions regarding installation of a mobile two-way radio system.

امداد خودرو فارما

تلفن شبانه روزی: ۰۲۱-۸۸۸۶۲۰۸۵

FarmaSOS.com

Vehicle data recording

Your Lexus is equipped with several sophisticated computers that will record certain data, such as:

- Engine speed
- Accelerator status
- Brake status
- Vehicle speed
- Shift position

The recorded data varies according to the vehicle grade level and options with which it is equipped. Furthermore, these computers do not record conversations, sounds or pictures.

● Data usage

Lexus may use the data recorded in these computers to diagnose malfunctions, conduct research and development, and improve quality.

Lexus will not disclose the recorded data to a third party except:

- With the consent of the vehicle owner or with the consent of the lessee if the vehicle is leased
- In response to an official request by the police, a court of law or a government agency
- For use by Lexus in a law suit
- For research purposes where the data is not tied to a specific vehicle or vehicle owner

● Usage of data collected through Safety Connect / Lexus Enform (U.S. mainland only)

If your Lexus has Safety Connect or Lexus Enform and if you have subscribed to those services, please refer to the Safety Connect / Lexus Enform Telematics Subscription Service Agreement for information on data collected and its usage.

Event data recorder

This vehicle is equipped with an event data recorder (EDR). The main purpose of an EDR is to record, in certain crash or near crash-like situations, such as an air bag deployment or hitting a road obstacle, data that will assist in understanding how a vehicle's systems performed. The EDR is designed to record data related to vehicle dynamics and safety systems for a short period of time, typically 30 seconds or less.

The EDR in this vehicle is designed to record such data as:

- How various systems in your vehicle were operating;
- Whether or not the driver and passenger safety belts were buckled/fastened;
- How far (if at all) the driver was depressing the accelerator and/or brake pedal; and,
- How fast the vehicle was traveling.

These data can help provide a better understanding of the circumstances in which crashes and injuries occur.

NOTE: EDR data are recorded by your vehicle only if a non-trivial crash situation occurs; no data are recorded by the EDR under normal driving conditions and no personal data (e.g., name, gender, age, and crash location) are recorded. However, other parties, such as law enforcement, could combine the EDR data with the type of personally identifying data routinely acquired during a crash investigation.

To read data recorded by an EDR, special equipment is required, and access to the vehicle or the EDR is needed. In addition to the vehicle manufacturer, other parties, such as law enforcement, that have the special equipment, can read the information if they have access to the vehicle or the EDR.

● Disclosure of the EDR data

Lexus will not disclose the data recorded in an EDR to a third party except when:

- An agreement from the vehicle's owner (or the lessee for a leased vehicle) is obtained
- In response to an official request by the police, a court of law or a government agency
- For use by Lexus in a law suit

However, if necessary, Lexus may:

- Use the data for research on vehicle safety performance
- Disclose the data to a third party for research purposes without disclosing information about the specific vehicle or vehicle owner

Scrapping of your Lexus

The SRS airbag and seat belt pretensioner devices in your Lexus contain explosive chemicals. If the vehicle is scrapped with the airbags and seat belt pretensioners left as they are, this may cause an accident such as fire. Be sure to have the systems of the SRS airbag and seat belt pretensioner removed and disposed of by a qualified service shop or by your Lexus dealer before you scrap your vehicle.

Perchlorate Material

Special handling may apply, See www.dtsc.ca.gov/hazardouswaste/perchlorate.

Your vehicle has components that may contain perchlorate. These components may include airbag, seat belt pretensioners, and wireless remote control batteries.

CAUTION

■ General precautions while driving

Driving under the influence: Never drive your vehicle when under the influence of alcohol or drugs that have impaired your ability to operate your vehicle. Alcohol and certain drugs delay reaction time, impair judgment and reduce coordination, which could lead to an accident that could result in death or serious injury.

Defensive driving: Always drive defensively. Anticipate mistakes that other drivers or pedestrians might make and be ready to avoid accidents.

Driver distraction: Always give your full attention to driving. Anything that distracts the driver, such as adjusting controls, talking on a cellular phone or reading can result in a collision with resulting death or serious injury to you, your occupants or others.

■ General precaution regarding children's safety

Never leave children unattended in the vehicle, and never allow children to have or use the key.

Children may be able to start the vehicle or shift the vehicle into neutral. There is also a danger that children may injure themselves by playing with the windows, the moon roof, or other features of the vehicle. In addition, heat build-up or extremely cold temperatures inside the vehicle can be fatal to children.

امداد خودرو فارما

تلفن شبانه روزی: ۰۲۱-۸۸۸۶۲۰۸۵

FarmaSOS.com

Reading this manual

 **CAUTION:**
Explains something that, if not obeyed, could cause death or serious injury to people.

 **NOTICE:**
Explains something that, if not obeyed, could cause damage to or a malfunction in the vehicle or its equipment.

... Indicates operating or working procedures. Follow the steps in numerical order.

 Indicates the action (pushing, turning, etc.) used to operate switches and other devices.

 Indicates the outcome of an operation (e.g. a lid opens).

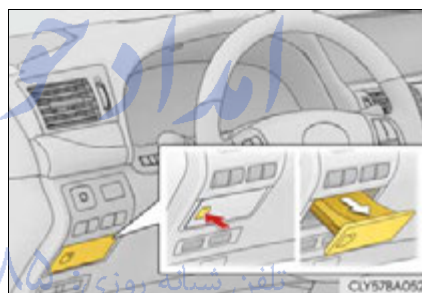

 Indicates the component or position being explained.

 Means "Do not", "Do not do this", or "Do not let this happen".

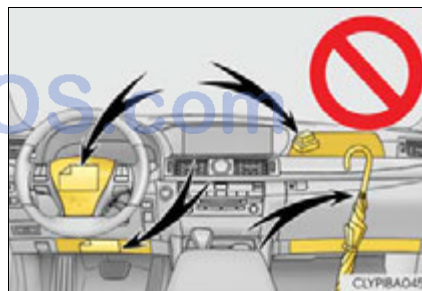

How to search

■ Searching by name

- Alphabetical index P. 610

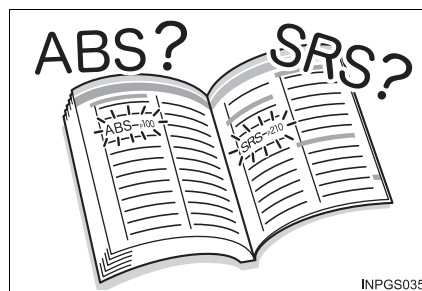

■ Searching by installation position

- Pictorial index P. 16

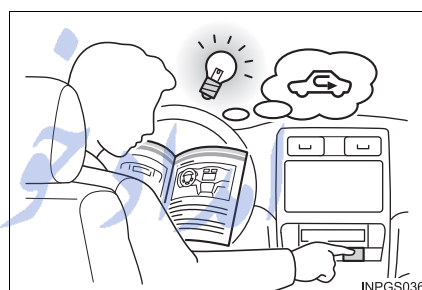

■ Searching by symptom or sound

- What to do if...
(Troubleshooting) P. 604



■ Searching by title

- Table of contents P. 2

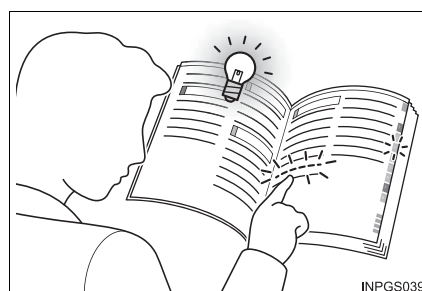

Pictorial index

Exterior

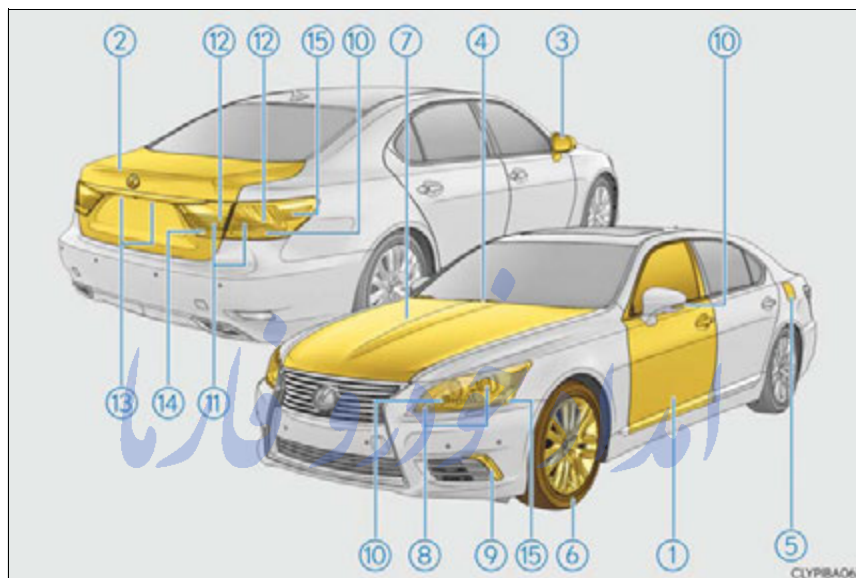

The shape of the headlights may differ depending on the grade, etc. (→P. 296)

- ① **Doors** P. 133
 - Locking/unlocking P. 115, 129
 - Opening/closing the door glasses P. 181
 - Locking/unlocking by using the mechanical key P. 536
 - Warning lights/warning messages P. 507, 514
- ② **Trunk** P. 137
 - Opening from inside the cabin P. 137
 - Opening from outside P. 115, 129
 - Opening by using the mechanical key P. 537
 - Warning lights/warning messages P. 507, 514
- ③ **Outside rear view mirrors** P. 177
 - Adjusting the mirror angle P. 177
 - Folding the mirrors P. 178
 - Driving position memory P. 163
 - Defogging the mirrors P. 359

- ④ **Windshield wipers** P. 241
 - Precautions against winter season P. 321
 - To prevent freezing (windshield wiper de-icer)* P. 360
 - Precautions against car wash P. 430
- ⑤ **Fuel filler door** P. 246
 - Refueling method P. 246
 - Fuel type/fuel tank capacity P. 553
- ⑥ **Tires** P. 464
 - Tire size/inflation pressure P. 559
 - Winter tires/tire chain P. 321
 - Checking/rotation/tire pressure warning system P. 464
 - Coping with flat tires P. 518, 527
- ⑦ **Hood** P. 446
 - Opening P. 446
 - Engine compartment cover P. 451
 - Engine oil P. 553
 - Coping with overheat P. 543
 - Warning messages P. 514

Light bulbs of the exterior lights for driving

(Replacing method: P. 491)

- ⑧ **Headlights/parking lights/daytime running lights** P. 231
- ⑨ **Fog lights** P. 240
- ⑩ **Turn signal lights** P. 224
- ⑪ **Tail lights** P. 231
- ⑫ **Stop lights**
 - Hill-start assist control P. 286
- ⑬ **License plate lights** P. 231
- ⑭ **Back-up lights**
 - Shifting the shift lever to R P. 213, 218
- ⑮ **Side marker lights** P. 231

*: If equipped

■ Instrument panel

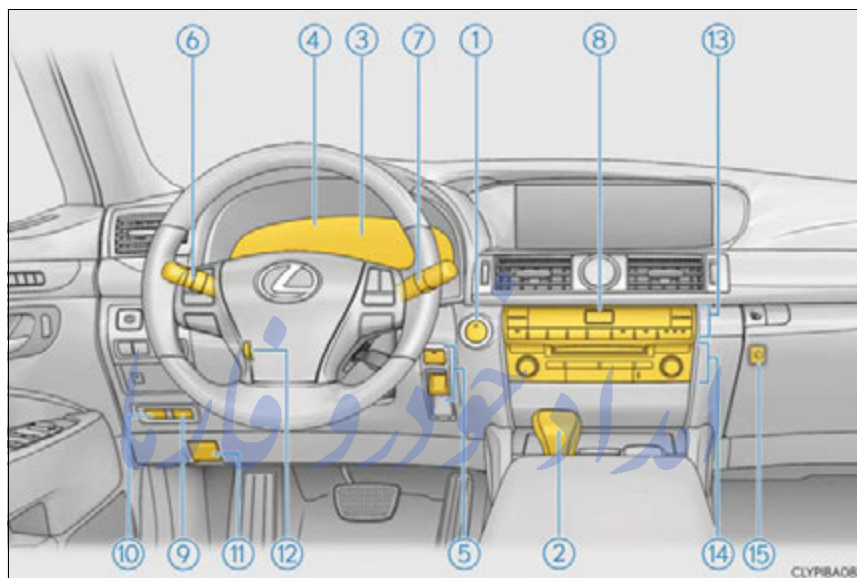

- ① **Engine switch** P. 208
 - Starting the engine/changing the modes P. 208
 - Emergency stop of the engine P. 495
 - When the engine will not start P. 529
 - Warning messages P. 514
- ② **Shift lever** P. 213, 218
 - Changing the shift position P. 213, 218
 - Precautions against towing P. 496
 - When the shift lever does not move P. 531
- ③ **Meters** P. 89
 - Reading the meters/adjusting the instrument panel light P. 89
 - Warning lights/indicator lights P. 84
 - When the warning lights come on P. 504

④	Multi-information display	P. 94
	Display	P. 94
	When the warning messages are displayed	P. 514
⑤	Parking brake switches	P. 225
	Applying/releasing	P. 225
	Precautions against winter season	P. 322
	Warning buzzer/message	P. 514
⑥	Turn signal lever	P. 224
	Headlight switch	P. 231
	Headlights/parking lights/tail lights/daytime running lights	P. 231
	Fog lights	P. 240
⑦	Windshield wiper and washer switch	P. 241
	Usage	P. 241
	Adding washer fluid	P. 463
	Warning messages	P. 514
⑧	Emergency flasher switch	P. 494
⑨	Trunk opener	P. 137
⑩	Fuel filler door opener	P. 248
⑪	Hood lock release lever	P. 446
⑫	Tilt and telescopic steering control switch	P. 174
	Adjustment	P. 174
	Driving position memory	P. 163
⑬	Air conditioning system	P. 334
	Usage	P. 334
	Rear window defogger	P. 359
⑭	Audio system *	
	Audio system *	
	Hands-free system *	
⑮	Trunk opener main switch	P. 138

*: Refer to "NAVIGATION AND MULTIMEDIA SYSTEM OWNER'S MANUAL".

■ Instrument panel switches



- ① Outside rear view mirror switches P.177
- ② Instrument panel light control switches P.91
- ③ Headlight cleaner switch *1 P.245
- ④ Intuitive parking assist switch *2
- ⑤ BSM (Blind Spot Monitor) main switch *1 P.306
- ⑥ Heated steering wheel switch *1 P.392
- ⑦ Automatic High Beam switch *1 P.235
- ⑧ Odometer/trip meter and trip meter reset switches P.91
- ⑨ Lexus night view switch *1 P.316

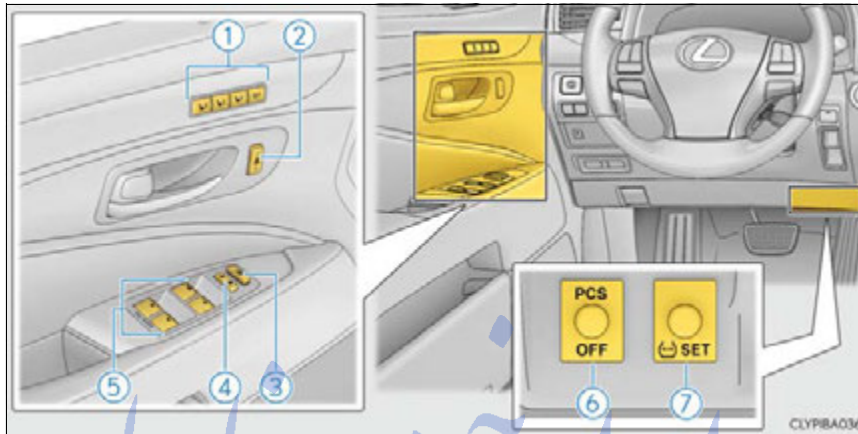

① Driving position memory switches	P.163
② Shoulder anchor control switches	P.39
③ Window lock switch	P.181
④ Door lock switches	P.133
⑤ Power window switches	P.181
⑥ Pre-collision braking off switch*1	P.295
⑦ Tire pressure warning reset switch.....	P.467

FarmaSOS.com

*1: If equipped

*2: Refer to "NAVIGATION AND MULTIMEDIA SYSTEM OWNER'S MANUAL".



- ① Audio remote control switches*1
- ② Paddle shift switches*2 P. 214, 220
- ③ Back switch*1
- ④ Talk switch*1
- ⑤ Phone switches*1
- ⑥ "DISP" button P. 95
- ⑦ Vehicle-to-vehicle distance button*2 P. 257
- ⑧ Cruise control switch
Cruise control*2 P. 250
Dynamic radar cruise control with full-speed range*2 P. 254
- ⑨ LKA (Lane-Keeping Assist) switch*2 P. 273
- ⑩ Brake hold switch P. 228

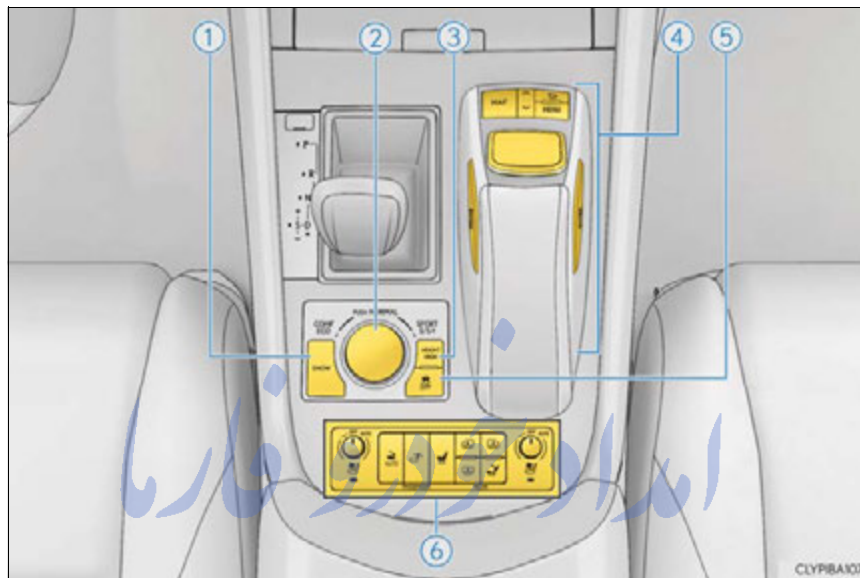

- ① Snow mode switchP. 216, 222
- ② Driving mode select switch..... P. 281
- ③ Vehicle height adjustment switch *2 P. 284
- ④ Remote Touch *1 P. 326
- ⑤ VSC (Vehicle Stability Control) OFF switch.....P. 288
- ⑥ Seat and interior feature switches *3
 - Rear sunshade switch *2 P. 402
 - Rear door sunshade switches *2 P. 406
 - Front climate control seat switches *2 P. 394
 - Rear seat return switch *2P. 153
 - Front passenger's power seat switches *2P. 145

*1: Refer to "NAVIGATION AND MULTIMEDIA SYSTEM OWNER'S MANUAL".

*2: If equipped

*3: Location of the switches varies according to the vehicle grade level.

■ Front interior

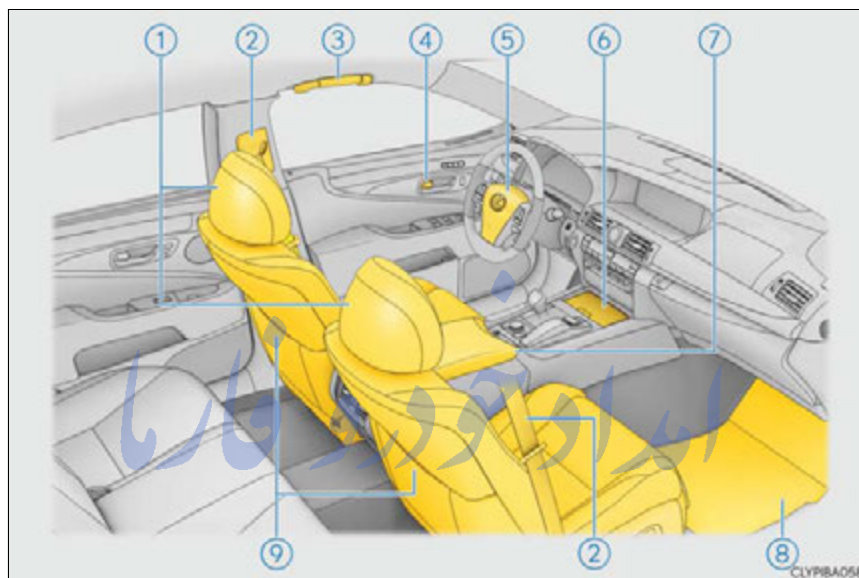

① Head restraints	P.170
② Seat belts	P. 38
③ Assist grips	P.412
④ Inside lock buttons	P.133
⑤ SRS airbags	P.44
⑥ Cup holders	P.369
Power outlet* ¹	P.388
Cigarette lighter* ¹	P.386
⑦ Console box	P.371
Power outlet	P.388
AUX port* ²	
USB ports* ²	
⑧ Floor mats	P.34
⑨ Front seats	P.144

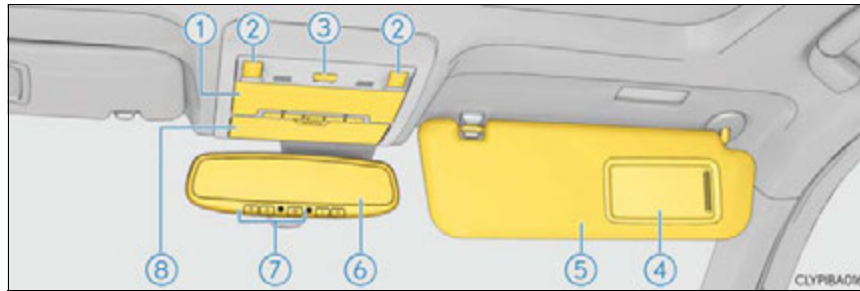

① Interior light	P. 362
Personal lights	P. 363
② Moon roof switches	P. 185
③ "SOS" button *1	P. 420
④ Vanity mirrors	P. 382
⑤ Sun visors	P. 382
⑥ Inside rear view mirror	P. 175
⑦ Garage door opener switches	P. 413
⑧ Auxiliary box	P. 376

تلفن شبانه روزی: ۰۸۵-۸۸۶۲۰۸۵-۲۱

FarmaSOS.com

*1: If equipped

*2: Refer to "NAVIGATION AND MULTIMEDIA SYSTEM OWNER'S MANUAL".

■ Rear interior (5-seat models)

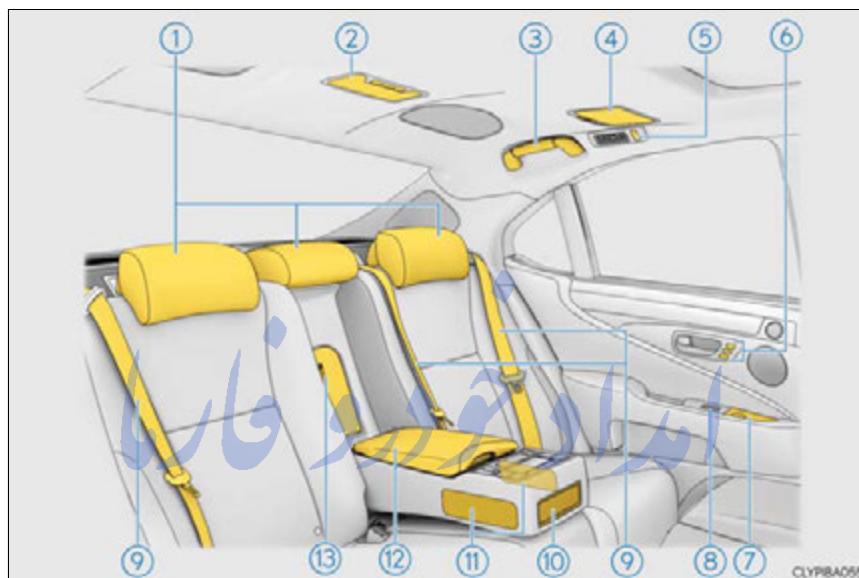

- | | | | |
|---|---|-------|-------|
| ① | Head restraints | | P.170 |
| ② | Interior light | | P.362 |
| | Personal lights | | P.363 |
| ③ | Assist grips | | P.412 |
| ④ | Vanity mirrors | | P.382 |
| ⑤ | Coat hooks | | P.411 |
| ⑥ | Seat position memory switches ^{*1} | | P.168 |

⑦	Auxiliary boxes ^{*1}	P.376
	Ashtrays ^{*1}	P.385
⑧	Power window switches	P.181
⑨	Seat belts	P.38
⑩	Cup holders.....	P.369
⑪	Pelvic support seat switches ^{*1}	P.155
	Rear seat relaxation system/ pelvic support seat switches ^{*1}	P.155, 157
⑫	Auxiliary box.....	P.376
	Rear seat entertainment system controller ^{*1,2} Headphone jacks ^{*1,2}	
⑬	Cool box/auxiliary box ^{*1}	P.373
	Trunk storage extension ^{*1}	P.409

تلفن شبانه روزی: ۰۲۱-۸۸۸۶۲۰۸۵

FarmaSOS.com

^{*1}: If equipped

^{*2}: Refer to "NAVIGATION AND MULTIMEDIA SYSTEM OWNER'S MANUAL".

■ Rear interior (4-seat models)

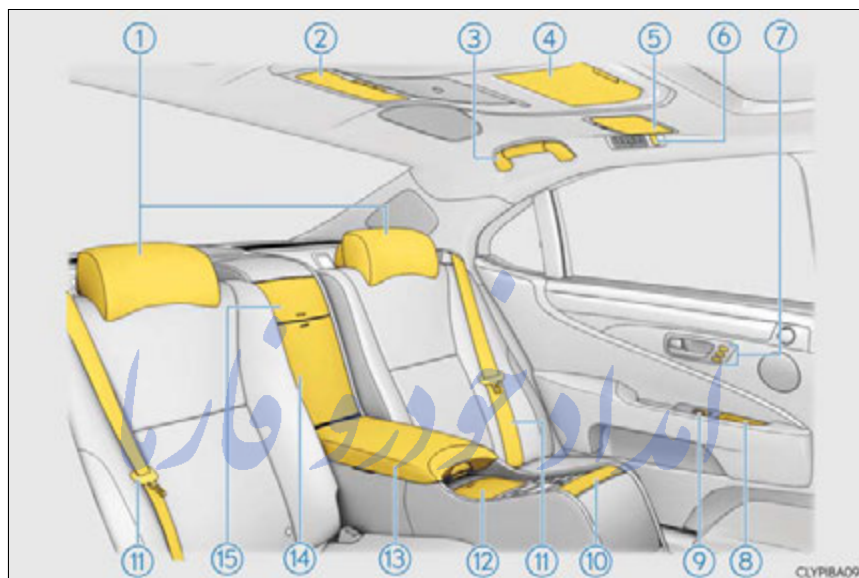

- | | | |
|---|---|-------|
| ① | Head restraints | P.170 |
| ② | Interior light | P.362 |
| | Personal lights | P.363 |
| ③ | Assist grips | P.412 |
| ④ | Rear seat entertainment system display *2 | P.382 |
| ⑤ | Vanity mirrors | P.411 |
| ⑥ | Coat hooks | P.168 |
| ⑦ | Seat position memory switches | |

- ⑧ Auxiliary boxes*¹ P.376
 Ashtrays*¹ P.385
- ⑨ Power window switches P.181
- ⑩ Retractable table P.400
- ⑪ Seat belts P.38
- ⑫ Cup holders..... P.369
- ⑬ Rear seat console
 Rear seat relaxation system/pelvic support seat controller P.155, 157
 Rear seat entertainment system controller*²
 Cigarette lighter*¹ P.386
 Power outlet*¹ P.388
 A/V input port (VTR and HDMI port)*²
 Cool box/auxiliary box P.373
- ⑭ Auxiliary box..... P.376
- ⑮ Rear seat entertainment system player*²
 Disc slot*²
 SD card slot*²
 Headphone jacks*²

تلفن شبانه روزی: ۰۸۵-۸۸۶۲۰۸۱۱

FarmaSOS.com

*¹: If equipped

*²: Refer to "NAVIGATION AND MULTIMEDIA SYSTEM OWNER'S MANUAL".

■ Rear interior switches



- ① Rear air conditioning switches *1 P. 352
- ② Rear sunshade switch *1,2 P. 402
Rear door sunshade switches *1 P. 406
- ③ Rear audio switches *1,3 P. 358
- ④ Rear climate control seat switches *1 P. 395
Rear seat heater switches *1 P. 395
- ⑤ Power rear seat switches *1,2 P. 150
Front passenger's seat control switches *1,2 P. 146, 154
Pelvic support seat switches *1,2 P. 155

FarmasOS.com

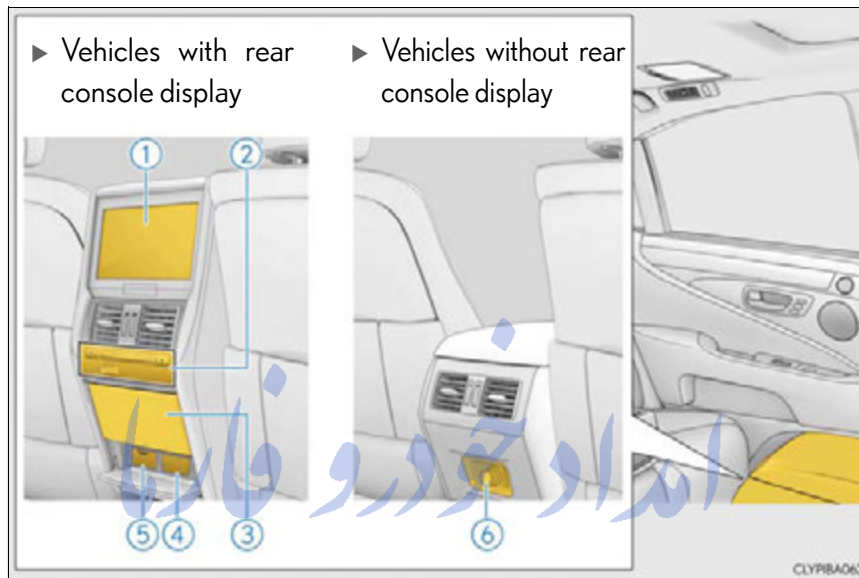

- ① Rear seat entertainment system display *3
- ② Rear seat entertainment system player *3
Disc slot *3
SD card slot *3
- ③ Auxiliary box..... P.376
- ④ Power outlet P.388
- ⑤ A/V input port (VTR and HDMI port) *3
- ⑥ Cigarette lighter *1 P.386
Power outlet *1 P.388

*1: If equipped

*2: Location of the switches varies according to the vehicle grade level.

*3: Refer to "NAVIGATION AND MULTIMEDIA SYSTEM OWNER'S MANUAL".

امداد خودرو فارما

تلفن شبانه روزی: ۰۲۱-۸۸۸۶۲۰۸۵

FarmaSOS.com

1-1. For safe use

Before driving.....	34
For safety drive.....	36
Seat belts	38
SRS airbags	44
Front passenger occupant classification system.....	57
Safety information for children	63
Child restraint systems	64
Installing child restraints.....	68
Exhaust gas precautions.....	77

1-2. Theft deterrent system

Engine immobilizer system.....	78
Alarm	80

تلفن شبانه روزی: ۰۲۱-۸۸۸۶۲۰۸۵

FarmaSOS.com

Before driving

Floor mat

Use only floor mats designed specifically for vehicles of the same model and model year as your vehicle. Fix them securely in place onto the carpet.

- 1 Insert the retaining hooks (clips) into the floor mat eyelets.

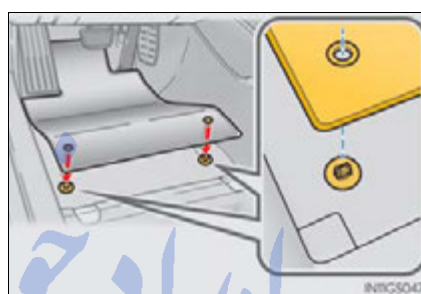

- 2 Turn the upper knob of each retaining hook (clip) to secure the floor mats in place.

*: Always align the Δ marks.

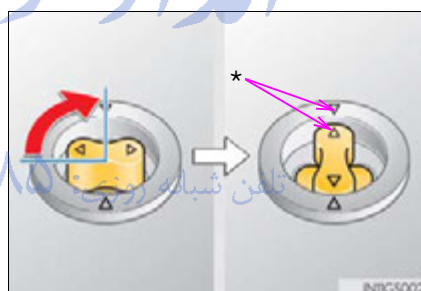

The shape of the retaining hooks (clips) may differ from that shown in the illustration.

⚠ CAUTION

Observe the following precautions.

Failure to do so may cause the driver's floor mat to slip, possibly interfering with the pedals while driving. An unexpectedly high speed may result or it may become difficult to stop the vehicle. This could lead to an accident, resulting in death or serious injury.

■ When installing the driver's floor mat

- Do not use floor mats designed for other models or different model year vehicles, even if they are Lexus Genuine floor mats.
- Only use floor mats designed for the driver's seat.
- Always install the floor mat securely using the retaining hooks (clips) provided.
- Do not use two or more floor mats on top of each other.
- Do not place the floor mat bottom-side up or upside-down.

■ Before driving

- Check that the floor mat is securely fixed in the correct place with all the provided retaining hooks (clips). Be especially careful to perform this check after cleaning the floor.
- With the engine stopped and the shift lever in P, fully depress each pedal to the floor to make sure it does not interfere with the floor mat.

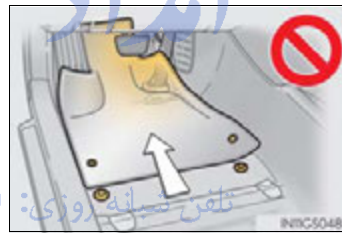

For safety drive

For safe driving, adjust the seat and mirror to an appropriate position before driving.

Correct driving posture

- ① Adjust the angle of the seatback so that you are sitting straight up and so that you do not have to lean forward to steer. (→P.144)
- ② Adjust the seat so that you can depress the pedals fully and so that your arms bend slightly at the elbow when gripping the steering wheel. (→P.144)
- ③ Lock the head restraint in place with the center of the head restraint closest to the top of your ears. (→P.170)
- ④ Wear the seat belt correctly. (→P.38)

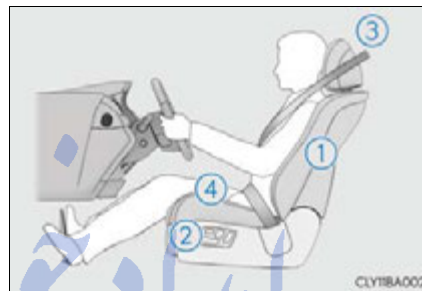

Correct use of the seat belts

Make sure that all occupants are wearing their seat belts before driving the vehicle. (→P.38)

Use a child restraint system appropriate for the child until the child becomes large enough to properly wear the vehicle's seat belt. (→P.64)

Adjusting the mirrors

Make sure that you can see backward clearly by adjusting the inside and outside rear view mirrors properly. (→P.175, 177)

CAUTION

Observe the following precautions.

Failure to do so may result in death or serious injury.

- Do not adjust the position of the driver's seat while driving.
Doing so could cause the driver to lose control of the vehicle.
- Do not place a cushion between the driver or passenger and the seatback.
A cushion may prevent correct posture from being achieved, and reduce the effectiveness of the seat belt and head restraint.
- Do not place anything under the front seats.
Objects placed under the front seats may become jammed in the seat tracks and stop the seat from locking in place. This may lead to an accident and the adjustment mechanism may also be damaged.
- When driving over long distances, take regular breaks before you start to feel tired.
Also, if you feel tired or sleepy while driving, do not force yourself to continue driving and take a break immediately.

1

For safety and security

FarmaSOS.com

Seat belts

Make sure that all occupants are wearing their seat belts before driving the vehicle.

Correct use of the seat belts

- Extend the shoulder belt so that it comes fully over the shoulder, but does not come into contact with the neck or slide off the shoulder.
- Position the lap belt as low as possible over the hips.
- Adjust the position of the seat-back. Sit up straight and well back in the seat.
- Do not twist the seat belt.



Fastening and releasing the seat belt

- ① To fasten the seat belt, push the plate into the buckle until a click sound is heard.
- ② To release the seat belt, press the release button.

If the seat belt cannot be pulled out of the retractor, firmly pull the belt and release it.

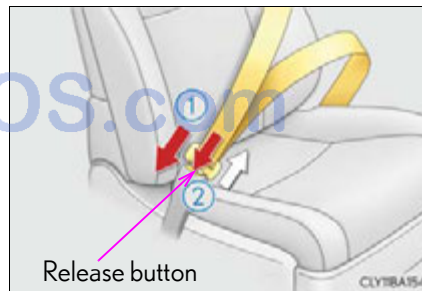

Adjusting the seat belt shoulder anchor height (front seats)

- ① Moves the seat belt shoulder anchor up
- ② Moves the seat belt shoulder anchor down



Seat belt comfort guide (outer rear seats)

For children or smaller-than-average people, slide the seat belt comfort guide forward so that the shoulder belt does not sit close to the person's neck.

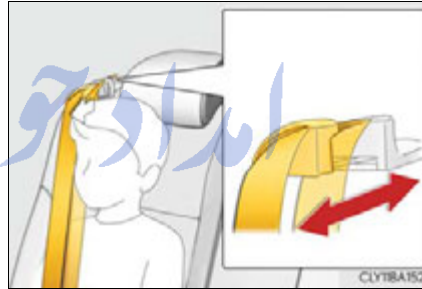

Seat belt pretensioners (front and outer rear seats)

The pretensioners help the seat belts to quickly restrain the occupants by retracting the seat belts when the vehicle is subjected to certain types of severe frontal collision.

The front seat belt pretensioners also activate when the vehicle is subjected to certain types of severe side collision.

The pretensioners do not activate in the event of a minor frontal impact, a minor side impact, a rear impact or a vehicle rollover.



Pre-collision seat belts (front seats of vehicles with pre-collision system)

If the system determines that a collision is unavoidable, the front seat belts will retract before the collision. (→P. 293)

■ Child seat belt usage

The seat belts of your vehicle were principally designed for persons of adult size.

- Use a child restraint system appropriate for the child, until the child becomes large enough to properly wear the vehicle's seat belt. (→P. 64)
- When the child becomes large enough to properly wear the vehicle's seat belt, follow the instructions regarding seat belt usage. (→P. 38)

■ Automatic adjustment of the seat belt shoulder anchor height (front seats)

A desired seat belt shoulder anchor height can be entered to memory and recalled automatically by the driving position memory and seat position memory. (→P. 163)

■ Emergency locking retractor (ELR)

The retractor will lock the belt during a sudden stop or on impact. It may also lock if you lean forward too quickly. A slow, easy motion will allow the belt to extend so that you can move around fully.

■ Automatic locking retractor (ALR)

When a passenger's shoulder belt is completely extended and then retracted even slightly, the belt is locked in that position and cannot be extended. This feature is used to hold the child restraint system (CRS) firmly. To free the belt again, fully retract the belt and then pull the belt out once more. (→P. 68)

■ Replacing the belt after the pretensioner has been activated

If the vehicle is involved in multiple collisions, the pretensioner will activate for the first collision, but will not activate for the second or subsequent collisions.

■ Seat belt extender

If your seat belts cannot be fastened securely because they are not long enough, a personalized seat belt extender is available from your Lexus dealer free of charge.

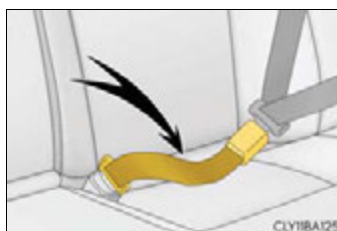

⚠ CAUTION

Observe the following precautions to reduce the risk of injury in the event of sudden braking, sudden swerving or an accident.

Failure to do so may cause death or serious injury.

■ Wearing a seat belt

- Ensure that all passengers wear a seat belt.
- Always wear a seat belt properly.
- Each seat belt should be used by one person only. Do not use a seat belt for more than one person at once, including children.
- Lexus recommends that children be seated in the rear seat and always use a seat belt and/or an appropriate child restraint system.
- To achieve a proper seating position, do not recline the seat more than necessary. The seat belt is most effective when the occupants are sitting up straight and well back in the seats.
- Do not wear the shoulder belt under your arm.
- Always wear your seat belt low and snug across your hips.

■ Pregnant women

Obtain medical advice and wear the seat belt in the proper way. (→P. 38)

Women who are pregnant should position the lap belt as low as possible over the hips in the same manner as other occupants, extending the shoulder belt completely over the shoulder and avoiding belt contact with the rounding of the abdominal area.

If the seat belt is not worn properly, not only the pregnant woman, but also the fetus could suffer death or serious injury as a result of sudden braking or a collision.



■ People suffering illness

Obtain medical advice and wear the seat belt in the proper way. (→P. 38)

⚠ CAUTION**■ When children are in the vehicle**

Do not allow children to play with the seat belt. If the seat belt becomes twisted around a child's neck, it may lead to choking or other serious injuries that could result in death.

If this occurs and the buckle cannot be unfastened, scissors should be used to cut the belt.

■ Seat belt pretensioners

● Do not place anything, such as a cushion, on the front passenger's seat. Doing so will disperse the passenger's weight, which prevents the sensor from detecting the passenger's weight properly. As a result, the seat belt pretensioner for the front passenger's seat may not activate in the event of a collision.

● If the pretensioner has activated, the SRS warning light will come on. In that case, the seat belt cannot be used again and must be replaced at your Lexus dealer.

■ Adjustable shoulder anchor

Always make sure the shoulder belt is positioned across the center of your shoulder. The belt should be kept away from your neck, but not falling off your shoulder. Failure to do so could reduce the amount of protection in an accident and cause death or serious injuries in the event of a sudden stop, sudden swerve or accident. (→P.39)

■ Seat belt damage and wear

● Do not damage the seat belts by allowing the belt, plate, or buckle to be jammed in the door.

● Inspect the seat belt system periodically. Check for cuts, fraying, and loose parts. Do not use a damaged seat belt until it is replaced. Damaged seat belts cannot protect an occupant from death or serious injury.

● Ensure that the belt and plate are locked and the belt is not twisted. If the seat belt does not function correctly, immediately contact your Lexus dealer.

● Replace the seat assembly, including the belts, if your vehicle has been involved in a serious accident, even if there is no obvious damage.

● Do not attempt to install, remove, modify, disassemble or dispose of the seat belts. Have any necessary repairs carried out by your Lexus dealer. Inappropriate handling may lead to incorrect operation.

 CAUTION

■ Using a seat belt extender

- Do not wear the seat belt extender if you can fasten the seat belt without the extender.
- Do not use the seat belt extender when installing a child restraint system because the belt will not securely hold the child restraint system, increasing the risk of death or serious injury in the event of an accident.
- The personalized extender may not be safe on another vehicle, when used by another person, or at a different seating position other than the one originally intended.

 NOTICE

■ When using a seat belt extender

When releasing the seat belt, press on the buckle release button on the extender, not on the seat belt.
This helps prevent damage to the vehicle interior and the extender itself.

تلفن شبانه روزی: ۰۲۱-۸۸۶۲۰۸۵

FarmaSOS.com

SRS airbags

The SRS airbags inflate when the vehicle is subjected to certain types of severe impacts that may cause significant injury to the occupants. They work together with the seat belts to help reduce the risk of death or serious injury.

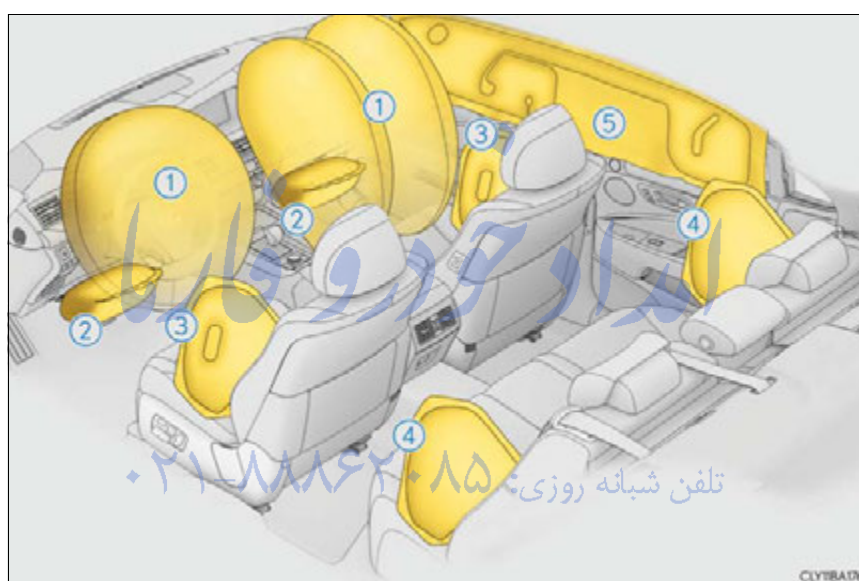

◆ SRS front airbags

- ① SRS driver airbag/front passenger airbag
Can help protect the head and chest of the driver and front passenger from impact with interior components
- ② SRS knee airbags
Can help provide driver and front passenger protection

◆ SRS side and curtain shield airbags

- ③ SRS front side airbags
Can help protect the torso of the front seat occupants
- ④ SRS rear side airbags (if equipped)
Can help protect the torso of occupants in the rear outer seats
- ⑤ SRS curtain shield airbags
Can help protect primarily the head of occupants in the outer seats

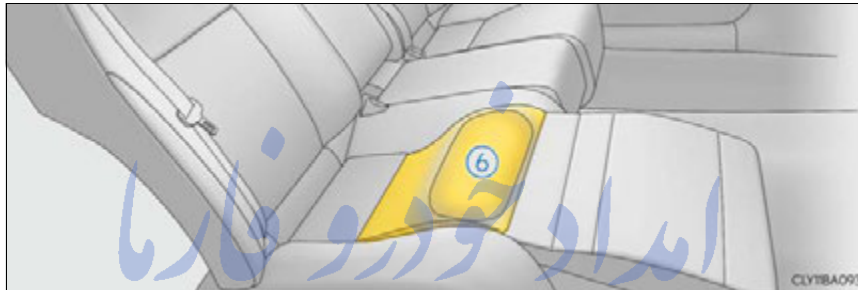

- ⑥ SRS seat cushion airbag (relaxation seat)
Can help restrain the relaxation seat occupant

تلفن شبانه روزی: ۰۲۱-۸۸۸۶۲۰۸۵

FarmaSOS.com

SRS airbag system components

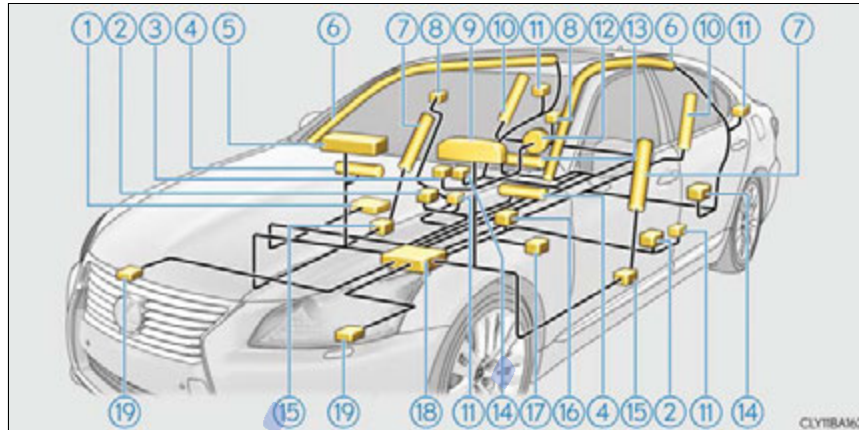

- | | |
|--|--|
| ① Front passenger occupant classification system (ECU and sensors) | ⑩ Rear side airbags (if equipped) |
| ② Side impact sensors (front) | ⑪ Seat belt pretensioners and force limiters |
| ③ "AIR BAG ON" and "AIR BAG OFF" indicator lights | ⑫ Driver airbag |
| ④ Knee airbags | ⑬ Seat cushion airbag (if equipped) |
| ⑤ Front passenger airbag | ⑭ Side impact sensors (rear) |
| ⑥ Curtain shield airbags | ⑮ Side impact sensors (front door) |
| ⑦ Front side airbags | ⑯ Driver's seat belt buckle switch |
| ⑧ Active head restraints | ⑰ Driver's seat position sensor |
| ⑨ SRS warning light | ⑱ Airbag sensor assembly |
| | ⑲ Front impact sensors |

Your vehicle is equipped with ADVANCED AIRBAGS designed based on the US motor vehicle safety standards (FMVSS208). The airbag sensor assembly (ECU) controls airbag deployment based on information obtained from the sensors etc. shown in the system components diagram above. This information includes crash severity and occupant information. As the airbags deploy, a chemical reaction in the inflators quickly fills the airbags with non-toxic gas to help restrain the motion of the occupants.

 CAUTION

■ SRS airbag precautions

Observe the following precautions regarding the SRS airbags. Failure to do so may cause death or serious injury.

- The driver and all passengers in the vehicle must wear their seat belts properly. The SRS airbags are supplemental devices to be used with the seat belts.
- The SRS driver airbag deploys with considerable force, and can cause death or serious injury especially if the driver is very close to the airbag. The National Highway Traffic Safety Administration (NHTSA) advises:

Since the risk zone for the driver's airbag is the first 2 - 3 in. (50 - 75 mm) of inflation, placing yourself 10 in. (250 mm) from your driver airbag provides you with a clear margin of safety. This distance is measured from the center of the steering wheel to your breastbone. If you sit less than 10 in. (250 mm) away now, you can change your driving position in several ways:

- Move your seat to the rear as far as you can while still reaching the pedals comfortably.
- Slightly recline the back of the seat. Although vehicle designs vary, many drivers can achieve the 10 in. (250 mm) distance, even with the driver seat all the way forward, simply by reclining the back of the seat somewhat. If reclining the back of your seat makes it hard to see the road, raise yourself by using a firm, non-slippery cushion, or raise the seat if your vehicle has that feature.
- If your steering wheel is adjustable, tilt it downward. This points the airbag toward your chest instead of your head and neck.

The seat should be adjusted as recommended by NHTSA above, while still maintaining control of the foot pedals, steering wheel, and your view of the instrument panel controls.

⚠ CAUTION**■ SRS airbag precautions**

- If the seat belt extender has been connected to the front seat belt buckle but the seat belt extender has not also been fastened to the latch plate of the seat belt, the SRS front airbags will judge that the driver and front passenger are wearing the seat belt even though the seat belt has not been connected. In this case, the SRS front airbags may not activate correctly in a collision, resulting in death or serious injury in the event of a collision. Be sure to wear the seat belt with the seat belt extender.



- The SRS front passenger airbag also deploys with considerable force, and can cause death or serious injury especially if the front passenger is very close to the airbag. The front passenger seat should be as far from the airbag as possible with the seatback adjusted, so the front passenger sits upright.
- Improperly seated and/or restrained infants and children can be killed or seriously injured by a deploying airbag. An infant or child who is too small to use a seat belt should be properly secured using a child restraint system. Lexus strongly recommends that all infants and children be placed in the rear seats of the vehicle and properly restrained. The rear seats are safer for infants and children than the front passenger seat. (→P. 64)
- Do not sit on the edge of the seat or lean against the dashboard.



CAUTION

■ SRS airbag precautions

- Do not allow a child to stand in front of the SRS front passenger airbag unit or sit on the knees of a front passenger.
- Do not allow the front seat occupants to hold items on their knees.
- Do not lean against the door, the roof side rail or the front, side and rear pillars.
- Do not allow anyone to kneel on the passenger seats toward the door or put their head or hands outside the vehicle.
- Do not attach anything to or lean anything against areas such as the dashboard, steering wheel pad and lower portion of the instrument panel. These items can become projectiles when the SRS driver, front passenger and knee airbags deploy.
- Do not attach anything to areas such as a door, windshield glass, side door glass, front and rear pillar, roof side rail and assist grip.

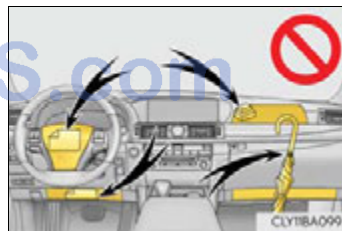
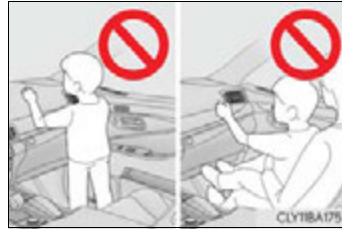

 CAUTION

■ SRS airbag precautions

- Do not hang coat hangers or hard objects on the coat hooks. All of these items could become projectiles and may cause death or serious injury, should the SRS curtain shield airbags deploy.
- If a vinyl cover is put on the area where the SRS knee airbag will deploy, be sure to remove it.
- Do not use seat accessories which cover the parts where the SRS side airbags and SRS seat cushion airbag inflate as they may interfere with inflation of the SRS airbags. Such accessories may prevent the side airbags and seat cushion airbag from activating correctly, disable the system or cause the side airbags and seat cushion airbag to inflate accidentally, resulting in death or serious injury.
- Do not strike or apply significant levels of force to the area of the SRS airbag components. Doing so can cause the SRS airbags to malfunction.
- Do not touch any of the component parts immediately after the SRS airbags have deployed (inflated) as they may be hot.
- If breathing becomes difficult after the SRS airbags have deployed, open a door or window to allow fresh air in, or leave the vehicle if it is safe to do so. Wash off any residue as soon as possible to prevent skin irritation.
- If the areas where the SRS airbags are stored, such as the steering wheel pad and front and rear pillar garnishes are damaged or cracked, have them replaced by your Lexus dealer.
- Do not place anything, such as a cushion, on the front passenger's seat. Doing so will disperse the passenger's weight, which prevents the sensor from detecting the passenger's weight properly. As a result, the SRS front passenger airbag may not deploy in the event of a collision.

⚠ CAUTION**■ Modification and disposal of SRS airbag system components**

Do not dispose of your vehicle or perform any of the following modifications without consulting your Lexus dealer. The SRS airbags may malfunction or deploy (inflate) accidentally, causing death or serious injury.

- Installation, removal, disassembly and repair of the SRS airbags
- Repairs, modifications, removal or replacement of the steering wheel, instrument panel, dashboard, seats or seat upholstery, front, side and rear pillars or roof side rails
- Repairs or modifications of the front fender, front bumper, or side of the occupant compartment
- Installation of a grille guard (bull bars, kangaroo bar, etc.), snow plows, winches
- Modifications to the vehicle's suspension system
- Installation of electronic devices such as mobile two-way radios and CD players
- Modifications to your vehicle for a person with a physical disability

1

For safety and security

تلفن شبانه روزی: ۰۲۱-۸۸۶۲۰۸۵

FarmaSOS.com

■ If the SRS airbags deploy (inflate)

- Slight abrasions, burns, bruising etc., may be sustained from SRS airbags, due to the extremely high speed deployment (inflation) by hot gases.
- A loud noise and white powder will be emitted.
- Parts of the airbag module (steering wheel hub, airbag cover and inflator) as well as the seats, parts of the front and rear pillars, and roof side rails may be hot for several minutes. The airbag itself may also be hot.
- The windshield may crack.
- For Lexus Enform Safety Connect subscribers, if the SRS airbags deploy or in the event of a severe rear-end collision, the system is designed to send an emergency call to the response center, notifying them of the vehicle's location (without needing to push the "SOS" button) and an agent will attempt to speak with the occupants to ascertain the level of emergency and assistance required. If the occupants are unable to communicate, the agent automatically treats the call as an emergency and helps to dispatch the necessary emergency services. (→P. 420)

■ SRS airbag deployment conditions (SRS front airbags and SRS seat cushion airbag)

- The SRS front airbags and SRS seat cushion airbag will deploy in the event of an impact that exceeds the set threshold level (the level of force corresponding to an approximately 12 - 18 mph [20 - 30 km/h] frontal collision with a fixed wall that does not move or deform).

However, this threshold velocity will be considerably higher in the following situations:

- If the vehicle strikes an object, such as a parked vehicle or sign pole, which can move or deform on impact
- If the vehicle is involved in an under-ride collision, such as a collision in which the front of the vehicle "under-rides", or goes under, the bed of a truck
- Depending on the type of collision, it is possible that only the seat belt pretensioners will activate.
- The SRS front airbags for the front passenger will not activate if there is no passenger sitting in the front passenger seat. However, the SRS front airbags for the front passenger may deploy if luggage is put in the seat, even if the seat is unoccupied. (→P. 57)

■ SRS airbag deployment conditions (SRS side and curtain shield airbags)

- The SRS side and curtain shield airbags will deploy in the event of an impact that exceeds the set threshold level (the level of force corresponding to the impact force produced by an approximately 3300 lb. [1500 kg] vehicle colliding with the vehicle cabin from a direction perpendicular to the vehicle orientation at an approximate speed of 12 - 18 mph [20 - 30 km/h]).
- The SRS side and curtain shield airbags will deploy in the event of a severe frontal collision.

■ Conditions under which the SRS airbags may deploy (inflate), other than a collision (SRS front airbags, SRS curtain shield airbag and SRS seat cushion airbag)

The SRS front airbags, SRS curtain shield airbag and SRS seat cushion airbag may also deploy if a serious impact occurs to the underside of your vehicle. Some examples are shown in the illustration.

- Hitting a curb, edge of pavement or hard surface
- Falling into or jumping over a deep hole
- Landing hard or falling

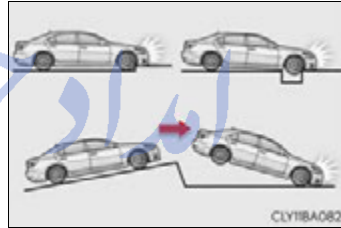

■ Types of collisions that may not deploy the SRS airbags (SRS front airbags and SRS seat cushion airbag)

The SRS front airbags and SRS seat cushion airbag do not generally inflate if the vehicle is involved in a side or rear collision, if it rolls over, or if it is involved in a low-speed frontal collision. But, whenever a collision of any type causes sufficient forward deceleration of the vehicle, deployment of the SRS front airbags and SRS seat cushion airbag may occur.

- Collision from the side
- Collision from the rear
- Vehicle rollover

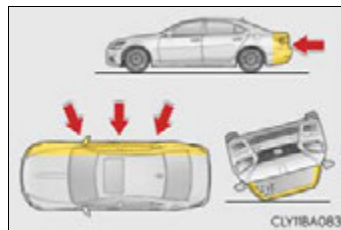

■ Types of collisions that may not deploy the SRS airbags (SRS side and SRS curtain shield airbags)

The SRS side and curtain shield airbags may not activate if the vehicle is subjected to a collision from the side at certain angles, or a collision to the side of the vehicle body other than the passenger compartment.

- Collision from the side to the vehicle body other than the passenger compartment
- Collision from the side at an angle

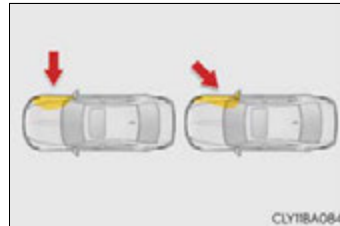

The SRS side airbags do not generally inflate if the vehicle is involved in a frontal or rear collision, if it rolls over, or if it is involved in a low-speed side collision.

- Collision from the front
- Collision from the rear
- Vehicle rollover

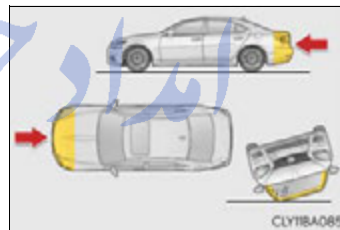

The SRS curtain shield airbags do not generally inflate if the vehicle is involved in a rear collision, if it rolls over, or if it is involved in a low-speed side or low-speed frontal collision.

- Collision from the rear
- Vehicle rollover



■ When to contact your Lexus dealer

In the following cases, the vehicle will require inspection and/or repair. Contact your Lexus dealer as soon as possible.

- Any of the SRS airbags have been inflated.
- The front of the vehicle is damaged or deformed, or was involved in an accident that was not severe enough to cause the SRS airbags to inflate.

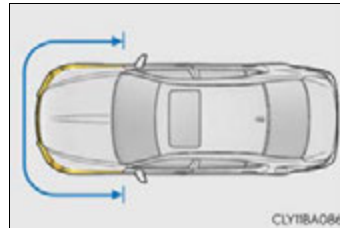

- A portion of a door is damaged or deformed, or the vehicle was involved in an accident that was not severe enough to cause the SRS side and curtain shield airbags to inflate.

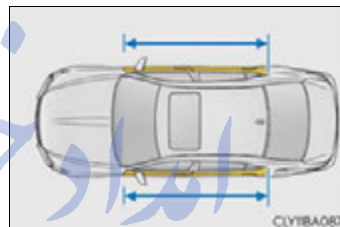

- The pad section of the steering wheel, dashboard near the front passenger airbag or lower portion of the instrument panel is scratched, cracked, or otherwise damaged.



- Relaxation seat: The seat cushion surface is scratched, cracked, or otherwise damaged.



- The surface of the seats with the side airbag is scratched, cracked, or otherwise damaged.

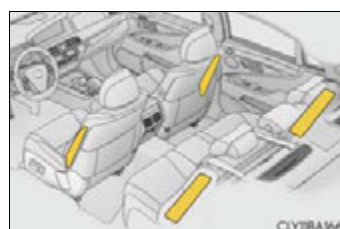

- The portion of the front pillars, rear pillars or roof side rail garnishes (padding) containing the curtain shield airbags inside is scratched, cracked, or otherwise damaged.

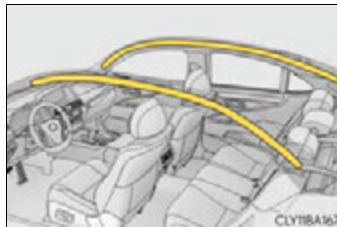

امداد خودرو فارما

تلفن شبانه روزی: ۰۲۱-۸۸۸۶۲۰۸۵

FarmaSOS.com

Front passenger occupant classification system

Your vehicle is equipped with a front passenger occupant classification system. This system detects the conditions of the front passenger seat and activates or deactivates the devices for the front passenger.



- ① Seat belt reminder light
- ② SRS warning light
- ③ "AIR BAG OFF" indicator light
- ④ "AIR BAG ON" indicator light

FarmaSOS.com

Condition and operation in the front passenger occupant classification system

■ Adult*¹

Indicator/ warning light	"AIR BAG ON" and "AIR BAG OFF" indicator lights	"AIR BAG ON"
	SRS warning light	Off
	Front passenger's seat belt reminder light	Flashing * ²
Devices	Front passenger airbag	Activated
	Side airbag on the right side passenger seats	
	Curtain shield airbag in the front passenger side	
	Front passenger knee airbag	
	Front passenger's seat belt pretensioner	
	Active head restraints	

■ Child*³ or child restraint system *⁴

Indicator/ warning light	"AIR BAG ON" and "AIR BAG OFF" indicator lights	"AIR BAG OFF"* ⁵
	SRS warning light	Off
	Front passenger's seat belt reminder light	Flashing * ²
Devices	Front passenger airbag	Deactivated
	Side airbag on the right side passenger seats	Activated
	Curtain shield airbag in the front passenger side	
	Front passenger knee airbag	Deactivated
	Front passenger's seat belt pretensioner	Activated
	Active head restraints	

■ Unoccupied

Indicator/ warning light	"AIR BAG ON" and "AIR BAG OFF" indicator lights	Not illuminated
	SRS warning light	Off
	Front passenger's seat belt reminder light	
Devices	Front passenger airbag	Deactivated
	Side airbag on the right side passenger seats	Activated
	Curtain shield airbag in the front passenger side	
	Front passenger knee airbag	Deactivated
	Front passenger's seat belt pretensioner	Deactivated or activated*6
	Active head restraints	Deactivated

■ There is a malfunction in the system

Indicator/ warning light	"AIR BAG ON" and "AIR BAG OFF" indicator lights	"AIR BAG OFF"
	SRS warning light	On
	Front passenger's seat belt reminder light	Off
Devices	Front passenger airbag	Deactivated
	Side airbag on the right side passenger seats	Activated
	Curtain shield airbag in the front passenger side	
	Front passenger knee airbag	Deactivated
	Front passenger's seat belt pretensioner	Activated
	Active head restraints	

1

For safety and security

- *1: The system judges a person of adult size as an adult. When a smaller adult sits in the front passenger seat, the system may recognize him/her as a child depending on his/her physique and posture.
- *2: In the event the front passenger does not wear a seat belt
- *3: When a larger child who has outgrown a child restraint system sits in the front passenger seat, the system may recognize him/her as an adult depending on his/her physique or posture.
- *4: Never install a rear-facing child restraint system on the front passenger seat. A forward-facing child restraint system should only be installed on the front passenger seat when it is unavoidable. (→P. 64)
- *5: In case the indicator light is not illuminated, consult this manual on how to install the child restraint system properly. (→P. 68)
- *6: Activated only in cases of side impact

امداد خودرو فارما

تلفن شبانه روزی: ۰۲۱-۸۸۸۶۲۰۸۵

FarmaSOS.com

 CAUTION**■ Front passenger occupant classification system precautions**

Observe the following precautions regarding the front passenger occupant classification system.

Failure to do so may cause death or serious injury.

- Wear the seat belt properly.
- Make sure the front passenger's seat belt plate has not been left inserted into the buckle before someone sits in the front passenger seat.
- Make sure the "AIR BAG OFF" indicator light is not illuminated when using the seat belt extender for the front passenger seat. If the "AIR BAG OFF" indicator light is illuminated, disconnect the extender tongue from the seat belt buckle, then reconnect the seat belt. Reconnect the seat belt extender after making sure the "AIR BAG ON" indicator light is illuminated. If you use the seat belt extender while the "AIR BAG OFF" indicator light is illuminated, the SRS airbags for the passenger may not activate correctly, which could cause death or serious injury in the event of a collision.
- Do not apply a heavy load to the front passenger seat or equipment (e.g. seat-back pockets or armrest).
- Do not put weight on the front passenger seat by putting your hands or feet on the front passenger seat seatback from the rear passenger seat.
- Do not let a rear passenger lift the front passenger seat with their feet or press on the seatback with their legs.
- Do not put objects under the front passenger seat.

1

For safety and security

FarmaSOS.com

 CAUTION**■ Front passenger occupant classification system precautions**

- Do not recline the front passenger seatback so far that it touches a rear seat. This may cause the "AIR BAG OFF" indicator light to be illuminated, which indicates that the passenger's airbags will not deploy in the event of a severe accident. If the seatback touches the rear seat, return the seatback to a position where it does not touch the rear seat. Keep the front passenger seatback as upright as possible when the vehicle is moving. Reclining the seatback excessively may lessen the effectiveness of the seat belt system.
- If an adult sits in the front passenger seat, the "AIR BAG ON" indicator light is illuminated. If the "AIR BAG OFF" indicator is illuminated, ask the passenger to sit up straight, well back in the seat, feet on the floor, and with the seat belt worn correctly. If the "AIR BAG OFF" indicator still remains illuminated, either ask the passenger to move to the rear seat, or if that is not possible, move the front passenger seat fully rearward.
- When it is unavoidable to install a forward-facing child restraint system on the front passenger seat, install the child restraint system on the front passenger seat in the proper order. (→P. 68)
- Do not modify or remove the front seats.
- Do not kick the front passenger seat or subject it to severe impact. Otherwise, the SRS warning light may come on to indicate a malfunction of the detection system. In this case, contact your Lexus dealer immediately.
- Child restraint systems installed on the rear seat should not contact the front seatbacks.
- Do not use a seat accessory, such as a cushion or seat cover, that covers the seat cushion surface.
- Do not modify or replace the upholstery of the front seat.

Safety information for children

Observe the following precautions when children are in the vehicle.
Use a child restraint system appropriate for the child, until the child becomes large enough to properly wear the vehicle's seat belt.

- It is recommended that children sit in the rear seats to avoid accidental contact with the shift lever, wiper switch etc.
- Use the rear door child-protector lock or the window lock switch to avoid children opening the door while driving or operating the power window accidentally.
- Do not let small children operate equipment which may catch or pinch body parts, such as the power window, hood, trunk, seats etc.

CAUTION

Never leave children unattended in the vehicle, and never allow children to have or use the key.

Children may be able to start the vehicle or shift the vehicle into neutral. There is also a danger that children may injure themselves by playing with the cigarette lighter, the windows, the moon roof, or other features of the vehicle. In addition, heat build-up or extremely cold temperatures inside the vehicle can be fatal to children.

Child restraint systems

A child restraint system for a small child or baby must itself be properly restrained on the seat with the LATCH anchors or the lap portion of the lap/shoulder belt.

The laws of all 50 states of the U.S.A. and Canada now require the use of child restraint systems.

Points to remember

Studies have shown that installing a child restraint on a rear seat is much safer than installing one on the front passenger seat.

- Choose a child restraint system that suits your vehicle and is appropriate to the age and size of the child.
- For installation details, follow the instructions provided with the child restraint system.

General installation instructions are provided in this manual. (→P. 68)

تلفن شبانه روزی: ۰۲۱-۸۸۸۶۲۰۸۵

FarmaSOS.com

Types of child restraints

Child restraint systems are classified into the following 3 types according to the age and size of the child:

- ▶ Rear facing — Infant seat/convertible seat
- ▶ Forward facing — Convertible seat

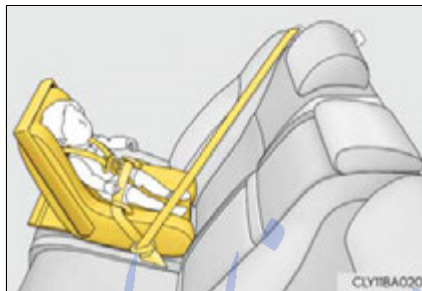

- ▶ Booster seat



■ Selecting an appropriate child restraint system

- Use a child restraint system appropriate for the child until the child becomes large enough to properly wear the vehicle's seat belt.
- If the child is too large for a child restraint system, sit the child on a rear seat and use the vehicle's seat belt. (→P. 38)

 CAUTION

■ Child restraint precautions

- For effective protection in automobile accidents and sudden stops, a child must be properly restrained, using a seat belt or child restraint system depending on the age and size of the child. Holding a child in your arms is not a substitute for a child restraint system. In an accident, the child can be crushed against the windshield, or between you and the vehicle's interior.
- Lexus strongly urges the use of a proper child restraint system that conforms to the size of the child, installed on the rear seat. According to accident statistics, the child is safer when properly restrained in the rear seat than in the front seat.
- Never install a rear-facing child restraint system on the front passenger seat even if the "AIR BAG OFF" indicator light is illuminated.
In the event of an accident, the force of the rapid inflation of the front passenger airbag can cause death or serious injury to the child if the rear-facing child restraint system is installed on the front passenger seat.
- A forward-facing child restraint system may be installed on the front passenger seat only when it is unavoidable. A child restraint system that requires a top tether strap should not be used in the front passenger seat since there is no top tether strap anchor for the front passenger seat. Adjust the seatback as upright as possible and always move the seat as far back as possible even if the "AIR BAG OFF" indicator light is illuminated, because the front passenger airbag could inflate with considerable speed and force. Otherwise, the child may be killed or seriously injured.
- Do not use the seat belt extender when installing a child restraint system on the front or rear passenger seat. If installing a child restraint system with the seat belt extender connected to the seat belt, the seat belt will not securely hold the child restraint system, which could cause death or serious injury to the child or other passengers in the event of an accident.
- Do not allow the child to lean his/her head or any part of his/her body against the door or the area of the seat, front and rear pillars or roof side rails from which the SRS side airbags or SRS curtain shield airbags deploy even if the child is seated in the child restraint system. It is dangerous if the SRS side airbags and curtain shield airbags inflate, and the impact could cause death or serious injury to the child.
- Make sure you have complied with all installation instructions provided by the child restraint manufacturer and that the system is properly secured. If it is not secured properly, it may cause death or serious injury to the child in the event of a sudden stop or accident.

⚠ CAUTION**■ When children are in the vehicle**

Do not allow children to play with the seat belt. If the seat belt becomes twisted around a child's neck, it may lead to choking or other serious injuries that could result in death.

If this occurs and the buckle cannot be unfastened, scissors should be used to cut the belt.

■ When the child restraint system is not in use

● Keep the child restraint system properly secured on the seat even if it is not in use. Do not store the child restraint system unsecured in the passenger compartment.

● If it is necessary to detach the child restraint system, remove it from the vehicle or store it securely in the trunk. This will prevent it from injuring passengers in the event of a sudden stop or accident.

1

For safety and security

امداد خودرو فارما

تلفن شبانه روزی: ۰۲۱-۸۸۶۲۰۸۵

FarmaSOS.com

Installing child restraints

Follow the child restraint system manufacturer's instructions. Firmly secure child restraints to the outer rear seats using the LATCH anchors or a seat belt. Attach the top tether strap when installing a child restraint.

The lap/shoulder belt can be used if your child restraint system is not compatible with the LATCH (Lower Anchors and Tethers for Children) system.

Child restraint LATCH anchors

LATCH anchors are provided for the outer rear seats. (Buttons displaying the location of the anchors are attached to the seats.)



Seat belts equipped with a child restraint locking mechanism (ALR/ELR belts except driver's seat belt) (→P.40)



► 5-seat models

Anchor brackets (for top tether strap)

An anchor bracket is provided for each rear seat.



► 4-seat models

Anchor brackets (for top tether strap)

An anchor bracket is provided for each rear seat.



Before installing the child restraint system on an outer rear seat (power rear seat)

When using a child restraint system in an outer rear seat, adjust the following:

- The seat cushion to the fully rearward position
- The upper seatback to the rear-most position
- The head restraint to the lowest and rear-most position
- Relaxation seat: The seatback to the most upright position and ottoman (footrest) to the stowed position

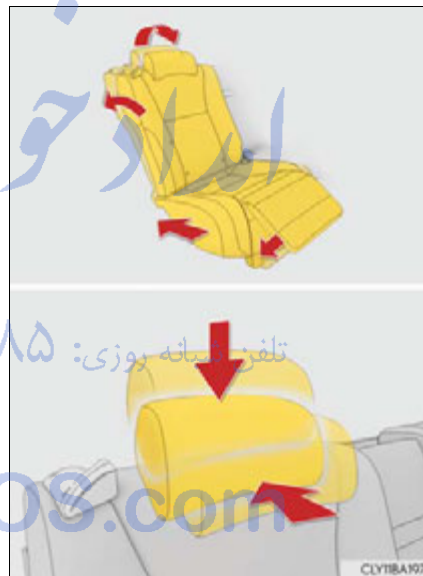

Installation with LATCH system

- 1 Widen the gap between the seat cushion and seatback slightly.

► Type A

- 2 Latch the hooks of the lower straps onto the LATCH anchors. If the child restraint has a top tether strap, the top tether strap should be latched onto the top tether strap anchor.

For owners in Canada:

The symbol on a child restraint system indicates the presence of a lower connector system.

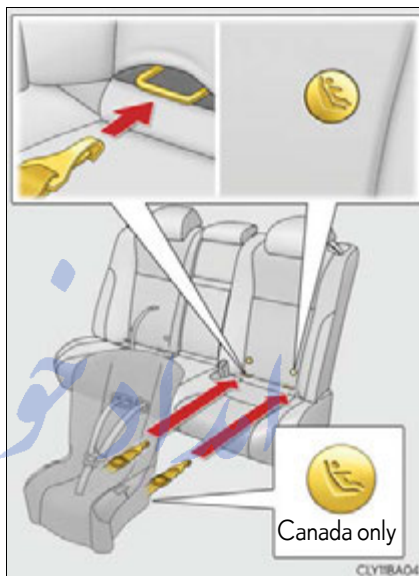

► Type B ۰۲۱-۸۸۶۲۰۸۵ تلفن شبانه روزی: FarmasOS.com

- 2 Latch the buckles onto the LATCH anchors. If the child restraint has a top tether strap, the top tether strap should be latched onto the top tether strap anchor.

For owners in Canada:

The symbol on a child restraint system indicates the presence of a lower connector system.

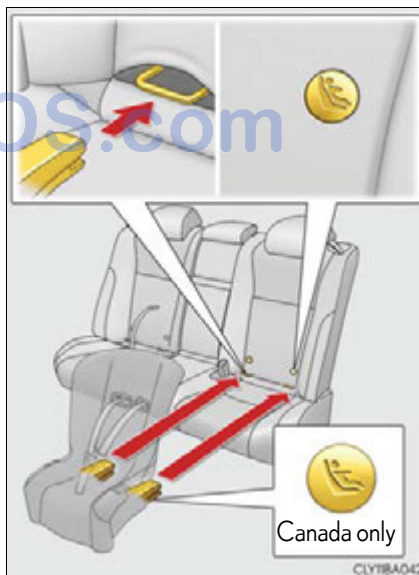

Installing child restraints using a seat belt (child restraint lock function belt)

■ Rear-facing — Infant seat/convertible seat

- 1 Place the child restraint system on the rear seat facing the rear of the vehicle.

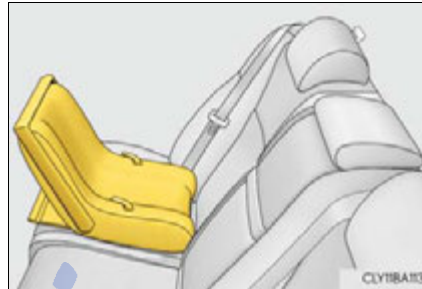

- 2 Run the seat belt through the child restraint system and insert the plate into the buckle. Make sure that the belt is not twisted.

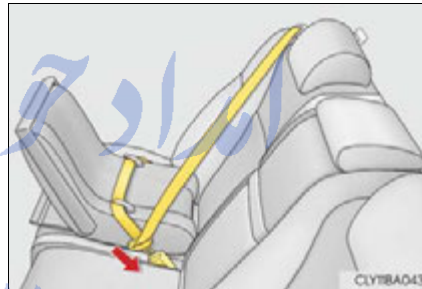

- 3 Fully extend the shoulder belt and allow it to retract to put it in lock mode. In lock mode, the belt cannot be extended.

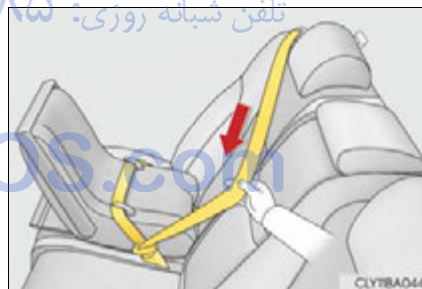

- 4 While pushing the child restraint system down into the rear seat, allow the shoulder belt to retract until the child restraint system is securely in place.

After the shoulder belt has retracted to a point where there is no slack in the belt, pull the belt to check that it cannot be extended.

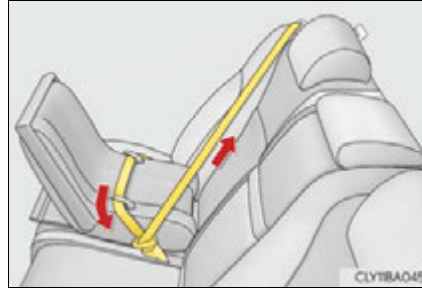

■ Forward-facing — Convertible seat

- 1 Place the child restraint system on the seat facing the front of the vehicle.

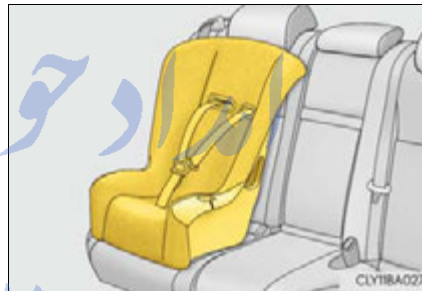

- 2 Run the seat belt through the child restraint system and insert the plate into the buckle. Make sure that the belt is not twisted.

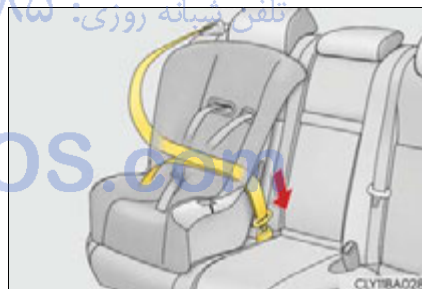

- 3 Fully extend the shoulder belt and allow it to retract to put it in lock mode. In lock mode, the belt cannot be extended.

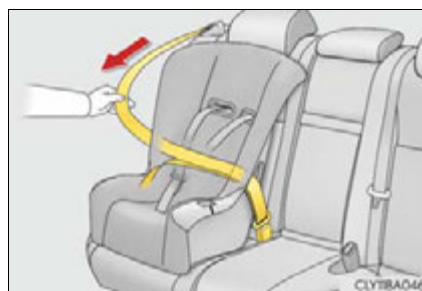

- 4 While pushing the child restraint system into the rear seat, allow the shoulder belt to retract until the child restraint system is securely in place.

After the shoulder belt has retracted to a point where there is no slack in the belt, pull the belt to check that it cannot be extended.



- 5 If the child restraint has a top tether strap, the top tether strap should be latched onto the top tether strap anchor. (→P. 74)

■ Booster seat

- 1 Place the child restraint system on the seat facing the front of the vehicle.



- 2 Sit the child in the child restraint system. Fit the seat belt to the child restraint system according to the manufacturer's instructions and insert the plate into the buckle. Make sure that the belt is not twisted.



Check that the shoulder belt is correctly positioned over the child's shoulder and that the lap belt is as low as possible. (→P. 38)

Removing a child restraint installed with a seat belt

Push the buckle release button and fully retract the seat belt.

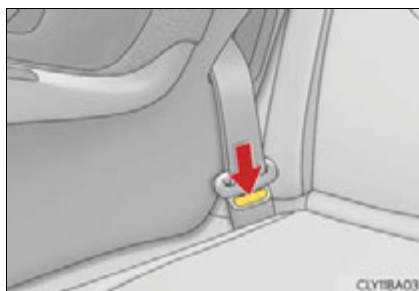

Child restraint systems with a top tether strap

- 1 Secure the child restraint system using the seat belt or the LATCH anchors and move the head restraint to the lowest position (outer rear seats) or fold the head restraint (rear center seat). (→P.170)

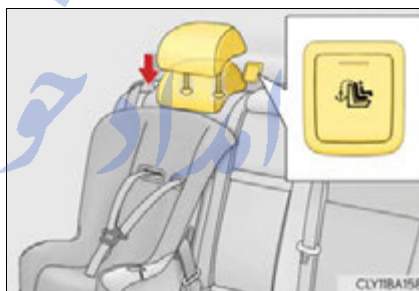

- 2 Open the anchor bracket cover, latch the hook onto the anchor bracket and tighten the top tether strap.

Make sure the top tether strap is securely latched.



■ Laws and regulations pertaining to anchorages

The LATCH system conforms to FMVSS225 or CMVSS210.2.

Child restraint systems conforming to FMVSS213 or CMVSS213 specifications can be used.

This vehicle is designed to conform to the SAE J1819.

⚠ CAUTION

■ **When installing a booster seat**

To prevent the belt from going into ALR lock mode, do not fully extend the shoulder belt. ALR mode causes the belt to tighten only. This could cause injury or discomfort to the child. (→P. 40)

■ **When installing a child restraint system**

Follow the directions given in the child restraint system installation manual and fix the child restraint system securely in place.

If the child restraint system is not correctly fixed in place, the child or other passengers may be seriously injured or even killed in the event of sudden braking or an accident.

- If the driver's seat interferes with the child restraint system and prevents it from being attached correctly, attach the child restraint system to the right-hand rear seat.



- Adjust the front passenger seat or rear seats so that it does not interfere with the child restraint system.

- Only put a forward-facing child restraint system on the front seat when unavoidable. When installing a forward-facing child restraint system on the front passenger seat, move the seat as far back as possible even if the "AIR BAG OFF" indicator light is illuminated. Failure to do so may result in death or serious injury if the airbags deploy (inflate).



⚠ CAUTION**■ When installing a child restraint system**

- When a booster seat is installed, always ensure that the shoulder belt is positioned across the center of the child's shoulder. The belt should be kept away from the child's neck, but not so that it could fall off the child's shoulder. Failing to do so may result in death or serious injury in the event of an accident or sudden braking.
- When using the LATCH anchors for a child restraint system, adjust the seatback as upright as possible.
- Ensure that the belt and plate are securely locked and the seat belt is not twisted.
- Shake the child restraint system left and right, and forward and backward to ensure that it has been securely installed.
- After securing a child restraint system, never adjust the seat.
- Follow all installation instructions provided by the child restraint system manufacturer.
- When securing some types of child restraint systems in rear seats, it may not be possible to properly use the seat belts in positions next to the child restraint without interfering with it or affecting seat belt effectiveness. Be sure your seat belt fits snugly across your shoulder and low on your hips. If it does not, or if it interferes with the child restraint, move to a different position. Failure to do so may result in death or serious injury.

■ Do not use a seat belt extender

If a seat belt extender is used when installing a child restraint system, the seat belt will not securely hold the child restraint system, which could cause death or serious injury to the child or other passengers in the event of a sudden braking, sudden swerving or an accident.

■ To correctly attach a child restraint system to the anchors

When using the LATCH anchors, be sure that there are no foreign objects around the anchors and that the seat belt is not caught behind the child restraint system. Make sure the child restraint system is securely attached, or it may cause death or serious injury to the child or other passengers in the event of sudden braking or an accident.

Exhaust gas precautions

Substances in the exhaust gases are harmful to the human body if inhaled.

CAUTION

Exhaust gases include harmful carbon monoxide (CO), which is colorless and odorless. Observe the following precautions.

Failure to do so may cause exhaust gases enter the vehicle and may lead to an accident caused by light-headedness, or may lead to death or a serious health hazard.

■ Important points while driving

Keep the trunk lid closed.

If you smell exhaust gases in the vehicle even when the trunk lid is closed, open the windows and have the vehicle inspected at your Lexus dealer as soon as possible.

■ When parking

- If the vehicle is in a poorly ventilated area or a closed area, such as a garage, stop the engine.
- Do not leave the vehicle with the engine on for a long time.
If such a situation cannot be avoided, park the vehicle in an open space and ensure that exhaust fumes do not enter the vehicle interior.
- Do not leave the engine running in an area with snow build-up, or where it is snowing. If snowbanks build up around the vehicle while the engine is running, exhaust gases may collect and enter the vehicle.

■ Exhaust pipe

The exhaust system needs to be checked periodically. If there is a hole or crack caused by corrosion, damage to a joint or abnormal exhaust noise, be sure to have the vehicle inspected and repaired by your Lexus dealer.

Engine immobilizer system

The vehicle's keys have built-in transponder chips that prevent the engine from starting if a key has not been previously registered in the vehicle's on-board computer.

Never leave the keys inside the vehicle when you leave the vehicle.

This system is designed to help prevent vehicle theft but does not guarantee absolute security against all vehicle thefts.

The indicator light flashes after the engine switch has been turned off to indicate that the system is operating.

The indicator light stops flashing after the engine switch has been turned to ACCESSORY or IGNITION ON mode to indicate that the system has been canceled.

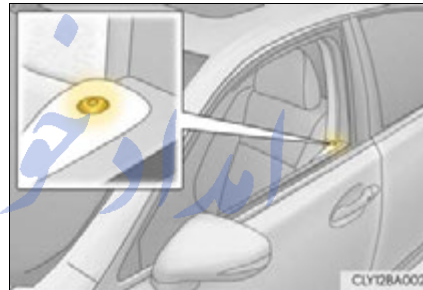

■ System maintenance

The vehicle has a maintenance-free type engine immobilizer system.

■ Conditions that may cause the system to malfunction

- If the grip portion of the key is in contact with a metallic object
- If the key is in close proximity to or touching a key to the security system (key with a built-in transponder chip) of another vehicle

■ Certifications for the engine immobilizer system

- For vehicles sold in the U.S.A., Hawaii, Guam and Puerto Rico

FCC ID: NI4TMIMB-1

This device complies with part 15 of the FCC Rules. Operation is subject to the following two conditions: (1) This device may not cause harmful interference; and (2) This device must accept any interference received, including interference that may cause undesired operation.

Changes or modifications not expressly approved by the party responsible for compliance could void the user's authority to operate the equipment.

- For vehicles sold in Canada

This device complies with Industry Canada licence-exempt RSSs. Operation is subject to the following two conditions: (1) This device may not cause interference; and (2) This device must accept any interference, including interference that may cause undesired operation of the device.

 **NOTICE****■ To ensure the system operates correctly**

Do not modify or remove the system. If modified or removed, the proper operation of the system cannot be guaranteed.

1

For safety and security

امداد خودرو فارما
تلفن شبانه روزی: ۰۲۱-۸۸۶۲۰۸۵

FarmaSOS.com

Alarm

The alarm

The alarm uses light and sound to give an alert when an intrusion is detected.

The alarm is triggered in the following situations when the alarm is set:

- A locked door or trunk is unlocked or opened in any way other than using the entry function, wireless remote control or mechanical key. (The doors will lock again automatically.)
- The hood is opened.

Setting the alarm system

Close the doors, trunk and hood, and lock all the doors. The system will be set automatically after 30 seconds.

The indicator light changes from being on to flashing when the system is set.



Deactivating or stopping the alarm

Do one of the following to deactivate or stop the alarms:

- Unlock the doors or open the trunk.
- Turn the engine switch to ACCESSORY or IGNITION ON mode, or start the engine. (The alarm will be deactivated or stopped after a few seconds.)

■ System maintenance

The vehicle has a maintenance-free type alarm system.

■ Items to check before locking the vehicle

To prevent unexpected triggering of the alarm and vehicle theft, make sure of the following:

- Nobody is in the vehicle.
- The windows and moon roof are closed before the alarm is set.
- No valuables or other personal items are left in the vehicle.

■ Triggering of the alarm

The alarm may be triggered in the following situations:
(Stopping the alarm deactivates the alarm system.)

- A person inside the vehicle opens a door, the trunk or hood.

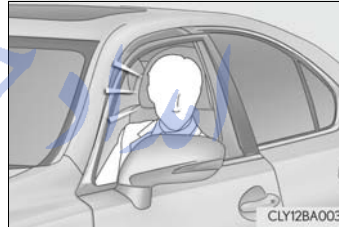

- The battery is recharged or replaced when the vehicle is locked. (→P. 541)

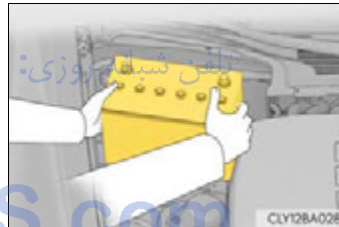

■ Alarm-operated door lock

- When the alarm is operating, the doors are locked automatically to prevent intruders.
- Do not leave the key inside the vehicle when the alarm is operating, and make sure the key is not inside the vehicle when recharging or replacing the battery.

⚠ NOTICE

■ To ensure the system operates correctly

Do not modify or remove the system. If modified or removed, the proper operation of the system cannot be guaranteed.

امداد خودرو فارما

تلفن شبانه روزی: ۰۲۱-۸۸۸۶۲۰۸۵

FarmaSOS.com

2. Instrument cluster	
Warning lights and indicators.....	84
Gauges and meters.....	89
Multi-information display	94
Fuel consumption information	102

امداد خودرو فارما

تلفن شبانه روزی: ۰۲۱-۸۸۸۶۲۰۸۵

FarmaSOS.com

Warning lights and indicators

The warning lights and indicators on the instrument cluster, center panel and outside rear view mirrors inform the driver of the status of the vehicle's various systems.

For the purpose of explanation, the following illustration displays all warning lights and indicators illuminated.

◆ Instrument cluster



The units used on the speedometer, the tachometer and some indicators may differ depending on the target region.

◆ Center panel

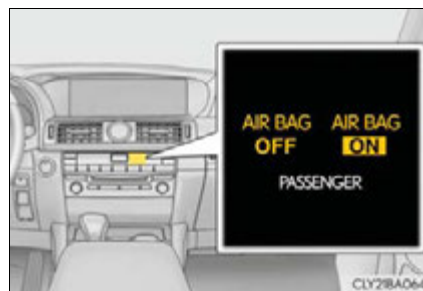

◆ Outside rear view mirrors (vehicles with BSM)











2

Warning lights

Warning lights inform the driver of malfunctions in the indicated vehicle's systems.

^{*1}  (U.S.A.)	Brake system warning light (→P. 504)	^{*1} 	Slip indicator (→P. 506)
^{*1}  (Canada)	Brake system warning light (→P. 504)	^{*1,2} 	Brake hold operated indicator (→P. 506)
^{*1}  (U.S.A.)	Charging system warning light (→P. 505)	^{*1,2}  (U.S.A.)	Parking brake indicator (→P. 506)
^{*1}  (U.S.A.)	Malfunction indicator lamp (→P. 505)	^{*1,2}  (Canada)	Parking brake indicator (→P. 506)
^{*1}  (Canada)	Malfunction indicator lamp (→P. 505)	^{*1} 	Brake system warning light (→P. 506)
^{*1}  (U.S.A.)	SRS warning light (→P. 505)	^{*1} 	Open door warning light (→P. 507)

Instrument cluster

^{*1}  ABS (U.S.A.)	ABS warning light (→P. 505)		Low fuel level warning light (→P. 507)
^{*1}  ABS (Canada)	ABS warning light (→P. 505)		Seat belt reminder light (→P. 507)
^{*1} 	Electric power steering system warning light (→P. 505)	^{*1} 	Master warning light (→P. 507)
^{*1,2}  PCS (if equipped)	Pre-collision system warn- ing light (→P. 506)	^{*1} 	Tire pressure warning light (→P. 508)

*1: These lights come on when the engine switch is turned to IGNITION ON mode to indicate that a system check is being performed. They will go off after the engine is on, or after a few seconds. There may be a malfunction in a system if the lights do not come on, or go off. Have the vehicle inspected by your Lexus dealer.

*2: The light flashes to indicate a malfunction.

تلفن شبانه روزی: ۰۲۱-۸۸۸۶۲۰۸۵

FarmaSOS.com

Indicators

The indicators inform the driver of the operating state of the vehicle's various systems.

	Turn signal indicator (→P. 224)		^{*1} Brake hold operated indicator (→P. 228)
	Headlight indicator (→P. 231) (U.S.A.)		Cruise control "SET" indicator (→P. 250, 254)
	Tail light indicator (→P. 231) (Canada)		Cruise control indicator (→P. 250, 254)
	Headlight high beam indicator (→P. 232)		Radar cruise control indicator (→P. 254) (if equipped)
	Automatic High Beam indicator (→P. 235) (if equipped)		LKA (Lane-Keeping Assist) indicator (→P. 271) (if equipped)
	Front fog light indicator (→P. 240)		^{*1} "HEIGHT HIGH" indicator (→P. 284) (if equipped)
	Snow mode indicator (→P. 216, 222)		^{*1, 2} Slip indicator (→P. 288)
	^{*1} Parking brake indicator (→ P. 225) (U.S.A.)		^{*1} VSC (Vehicle Stability Control) OFF indicator (→P. 289)
	^{*1} Parking brake indicator (→P. 225) (Canada)		^{*1, 3} Pre-collision system warning light (→P. 295) (if equipped)
	^{*1} Brake hold standby indicator (→P. 228)		^{*4} BSM (Blind Spot Monitor) outside rear view mirror indicators (→P. 306) (if equipped)



- *1: These lights come on when the engine switch is turned to IGNITION ON mode to indicate that a system check is being performed. They will go off after the engine is on, or after a few seconds. There may be a malfunction in a system if the lights do not come on, or go off. Have the vehicle inspected by your Lexus dealer.
- *2: The light flashes to indicate that the system is operating.
- *3: The light comes on when the system is turned off. The light flashes faster than usual to indicate that the system is operating.
- *4: In order to confirm operation, the BSM outside rear view mirror indicators illuminate in the following situations:
- When the engine switch is turned to IGNITION ON mode while the BSM main switch is set to ON.
 - When the BSM main switch is set to ON while the engine switch is in IGNITION ON mode.

If the system is functioning correctly, the BSM outside rear view mirror indicators will turn off after a few seconds.

If the BSM outside rear view mirror indicators do not illuminate or do not turn off, there may be a malfunction with the system.

If this occurs, have the vehicle inspected by your Lexus dealer.

CAUTION

If a safety system warning light does not come on

Should a safety system light such as the ABS and SRS warning light not come on when you start the engine, this could mean that these systems are not available to help protect you in an accident, which could result in death or serious injury. Have the vehicle inspected by your Lexus dealer immediately if this occurs.

Gauges and meters



The units used on the speedometer and the tachometer may differ depending on the target region.

- ① Engine coolant temperature gauge
Displays the engine coolant temperature
- ② Tachometer
Displays the engine speed in revolutions per minute
- ③ ECO lamp and SPORT lamp
Changes colors or brightness according to driving mode or way of driving (→P. 92)
- ④ Speedometer
Displays the vehicle speed
- ⑤ Fuel gauge
Displays the quantity of fuel remaining in the tank
- ⑥ Odometer/trip meter and trip meter reset switches
- ⑦ Multi-information display
Presents the driver with a variety of driving-related data (→P. 94)
- ⑧ Outside temperature
Displays the outside temperature within the range of -40°F (-40°C) to 122°F (50°C)

⑨ Odometer, trip meter and distance until next engine oil change display

Odometer:

Displays the total distance the vehicle has been driven

Trip meter:

Displays the distance the vehicle has been driven since the meter was last reset.

Trip meters "A" and "B" can be used to record and display different distances independently.

Distance until next engine oil change:

Displays the distance the vehicle can be driven until an oil change is necessary.

The distance until the next engine oil change will also be displayed in the following situations.

- When the engine switch is in IGNITION ON mode.
- When a warning message indicating that oil maintenance should be performed soon or is required is displayed.
- Resetting: →P. 455

⑩ Shift position and shift range

Displays the selected shift position or selected shift range (→P. 213, 218)

⑪ Instrument panel light control switches

تلفن شبانه روزی: ۰۲۱-۸۸۸۶۲۰۸۵

FarmaSOS.com

Changing the odometer and trip meter display

- ① Switches the display
- ② Resets the trip meter currently displayed to "0"

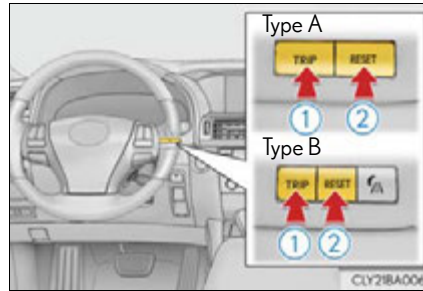

2

Instrument panel light control

The brightness of the instrument panel lights can be adjusted.

- ① Darker
- ② Brighter

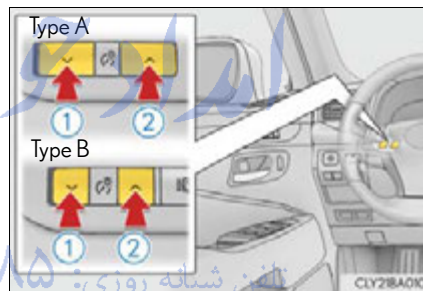

Instrument cluster

FarmaSOS.com

■ The meters and display illuminate when

The engine switch is in IGNITION ON mode.

■ Instrument panel brightness adjustment**● Meters:**

The brightness level of the meters when the surroundings are bright (day mode) and dark (night mode) can be adjusted individually. However, when in day mode, adjusting the brightness level will also change the brightness level of night mode.

● Clock, air conditioning temperature display and switch lights:

The brightness level of the clock, air conditioning temperature display and switch lights are linked with the brightness level of meter night mode.

■ Light dimmer control (Changing to night mode)

The brightness level of the meter, clock and air conditioning temperature display lights will change to night mode only when the surroundings are dark and the tail lights are on.

■ Automatic adjustment of the brightness level of the meters

The brightness level of the meters will be adjusted automatically according to the brightness of the surroundings detected by the light sensor. However, the brightness level of the meters will not be adjusted automatically in the following conditions.

● Day mode: When the brightness of the meter is adjusted to the brightest manually**● Night mode:** When the brightness of the meter is adjusted to the brightest or darkest manually**■ ECO lamp and SPORT lamp**

● When all of the following conditions are satisfied and Eco-friendly driving is being performed, ECO lamp (blue) will illuminate. (ECO lamp will become brighter the more Eco-friendly your driving is. Also, while the vehicle is stopped or the acceleration exceeds Zone of Eco driving, ECO lamp turns off. (→P. 96) However, when Eco drive mode is selected, while the vehicle is stopped or the acceleration exceeds Zone of Eco driving, ECO lamp does not turn off.):

- Driving with the shift lever in D.
- Vehicles with paddle shift switches: Paddle shift switch is not operated.
- Normal mode, comfort mode (if equipped) or Eco drive mode is selected, and snow mode is not in use.
- The vehicle speed is approximately 80 mph (130 km/h) or below.

● When sport mode is selected, SPORT lamp (red) will illuminate.

■ Outside temperature display

In the following situations, the correct outside temperature may not be displayed, or the display may take longer than normal to change.

- When stopped, or driving at low speeds (less than 12 mph [20 km/h])
- When the outside temperature has changed suddenly (at the entrance/exit of a garage, tunnel, etc.)

■ Customization

Settings (e.g. on/off operation of ECO lamp) can be changed.
(Customizable features →P. 578)

 **NOTICE****■ To prevent damage to the engine and its components**

- Do not let the indicator needle of the tachometer enter the red zone, which indicates the maximum engine speed.
- The engine may be overheating if the engine coolant temperature gauge is in the red zone (H). In this case, immediately stop the vehicle in a safe place, and check the engine after it has cooled completely. (→P. 543)

تلفن شبانه روزی: ۰۲۱-۸۸۶۲۰۸۵

FarmaSOS.com

Multi-information display

Display contents

The multi-information display presents the driver with a variety of driving-related data.

- Trip information (→P. 95)

Displays driving range, fuel consumption and other cruising related information

- Drive monitor (→P. 98)

Displays either the average fuel consumption after refueling or the driving range

- Intuitive parking assist display* (Refer to "NAVIGATION AND MULTIMEDIA SYSTEM OWNER'S MANUAL".)

- Dynamic radar cruise control with full-speed range display* (if equipped) (→P. 254)

- LKA (Lane-Keeping Assist) display* (if equipped) (→P. 275)

- Warning messages (→P. 514)

Automatically displayed when a malfunction occurs in one of the vehicle's systems. Display can be switched by pressing the "DISP" button. (→P. 95)

*: Automatically displayed when the system is used. Display can be switched by pressing the "DISP" button. (→P. 95)

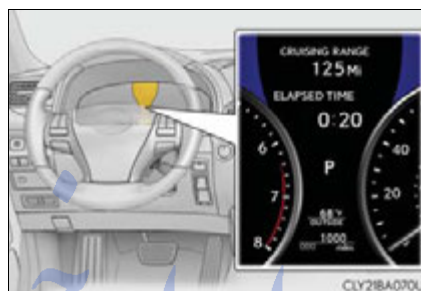

Trip information

■ Switching the display

Items displayed can be switched by pressing the “DISP” button.

The information displayed on the drive monitor will not be displayed on the trip information screen.

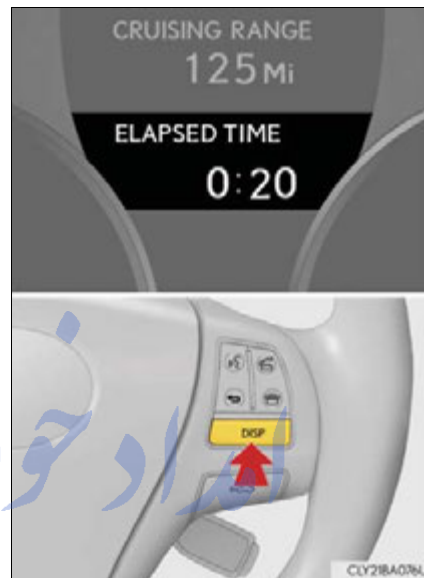

2

Instrument cluster

■ Driving range

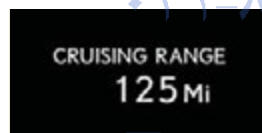

Displays the estimated approximate distance that can be driven with the quantity of fuel remaining

- This distance is computed based on your average fuel consumption. As a result, the actual distance that can be driven may differ from that displayed.
- When only a small amount of fuel is added to the tank, the display may not be updated.

When refueling, turn the engine switch off. If the vehicle is refueled without turning the engine switch off, the display may not be updated.

■ Eco Driving Indicator Zone Display and average fuel consumption

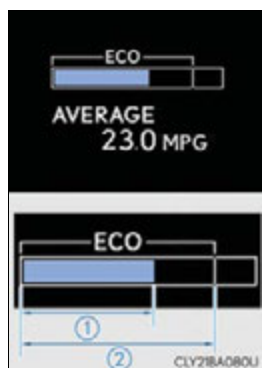

● Displays Eco Driving Indicator Zone Display

Suggests Zone of Eco driving and Eco driving ratio based on acceleration.

① Eco driving ratio based on acceleration

If the acceleration exceeds Zone of Eco driving, the right side of Eco Driving Indicator Zone Display blinks.

② Zone of Eco driving

Eco Driving Indicator will not operate in the following conditions:

- The shift lever is anything other than D.
- Vehicles with paddle shift switches: Paddle shift switch is operated.
- Normal mode, comfort mode (if equipped) or Eco drive mode is not selected. (→P. 281)
- The vehicle speed is approximately 80 mph (130 km/h) or higher.

● Displays the average fuel consumption since the function was reset

- The function can be reset by pressing the "DISP" button for longer than 1 second when the average fuel consumption is displayed.

On vehicles with a navigation system, the "Past Record" screen on the Remote Touch screen will also be updated. (→P. 104)

- Use the displayed average fuel consumption as a reference.

■ Current fuel consumption

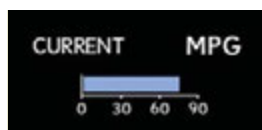

Displays the current rate of fuel consumption

■ Average fuel consumption after refueling



Displays the average fuel consumption since the vehicle was last refueled

Use the displayed average fuel consumption as a reference.

■ Distance after refueling



Displays the distance the vehicle has been driven since the vehicle was last refueled

■ Elapsed time

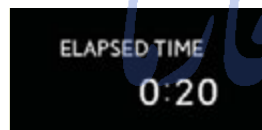

Displays the elapsed time since it was last reset

The function can be reset by pressing the "DISP" button for longer than 1 second when the elapsed time is displayed.

■ Average vehicle speed



Displays the average vehicle speed since the function was reset

The function can be reset by pressing the "DISP" button for longer than 1 second when the average vehicle speed is displayed.

■ Tire inflation pressure



Displays inflation pressure of each tire

■ Customization

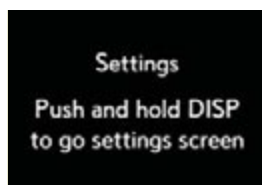

The multi-information display settings can be changed (→P. 99)

Drive monitor

Either average fuel consumption after refueling or driving range can be selected and displayed.

If displayed on the drive monitor, other trip information or warning messages can be displayed simultaneously.

For display and selection procedures, follow the "Setting up the displays".

The information displayed on the drive monitor will not be displayed on the trip information screen.

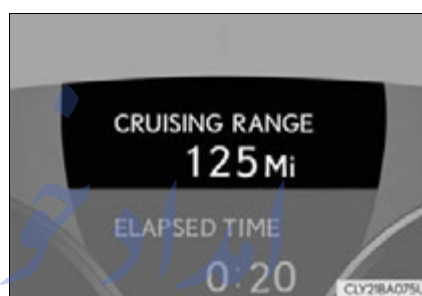

تلفن شبانه روزی: ۰۲۱-۸۸۶۲۰۸۵
FarmaSOS.com

Setting up the displays

- 1 While the vehicle is stopped, press the "DISP" button until the "Settings" screen appears.



- 2 Press and hold the "DISP" button until the screen changes.



- 3 Press and hold the "DISP" button after selecting the desired setting item by pressing the "DISP" button.



- 4 Press and hold the "DISP" button after selecting the desired setting by pressing the "DISP" button.

The display goes back to step 3.



2

Instrument cluster

- 5 Press and hold the “DISP” button after selecting the “EXIT” by pressing the “DISP” button.
The display goes back to step 1.

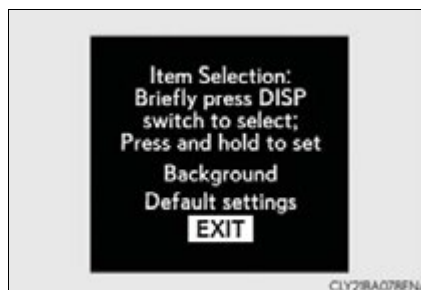

■ System check display

After turning the engine switch to IGNITION ON mode, “SYSTEM CHECK” is displayed while system operation is checked.

■ Tire inflation pressure

- It may take a few minutes to display the tire inflation pressure after the engine switch is turned to IGNITION ON mode. It may also take a few minutes to display the tire inflation pressure after inflation pressure has been adjusted.
- “---” may be displayed if the tire position information cannot be determined due to unfavorable radio wave conditions.
- Tire inflation pressure changes with temperature. The displayed values may also be different from the values measured using a tire pressure gauge.

■ When disconnecting and reconnecting battery terminals

The following information data will be reset:

- Driving range
- Average fuel consumption
- Average fuel consumption after refueling
- Distance after refueling
- Elapsed time
- Average vehicle speed

■ Liquid crystal display

Small spots or light spots may appear on the display. This phenomenon is characteristic of liquid crystal displays, and there is no problem continuing to use the display.

■ Customization

Setting of available languages can be changed. (Customizable features →P. 578)

 CAUTION**■ The information display at low temperatures**

Allow the interior of the vehicle to warm up before using the liquid crystal information display. At extremely low temperatures, the information display monitor may respond slowly, and display changes may be delayed.

For example, there is a lag between the driver's shifting and the new gear number appearing on the display. This lag could cause the driver to downshift again, causing rapid and excessive engine braking and possibly an accident resulting in death or injury.

■ Cautions during setting up the display

As the engine needs to be running during setting up the display, ensure that the vehicle is parked in a place with adequate ventilation. In a closed area such as a garage, exhaust gases including harmful carbon monoxide (CO) may collect and enter the vehicle. This may lead to death or a serious health hazard.

 NOTICE**■ During setting up the display**

To prevent battery discharge, ensure that the engine is running while setting up the display features.

امداد خودرو فارما
تلفن شبانه روزی: ۰۲۱-۸۸۶۲۰۸۵
FarmaSOS.com

Fuel consumption information

Fuel consumption information can be displayed on the Remote Touch screen.

The fuel consumption information can be displayed and operated on the side display.

- ① Remote Touch screen
- ② "MENU" button
- ③ Remote Touch knob
- ④ "ENTER" button

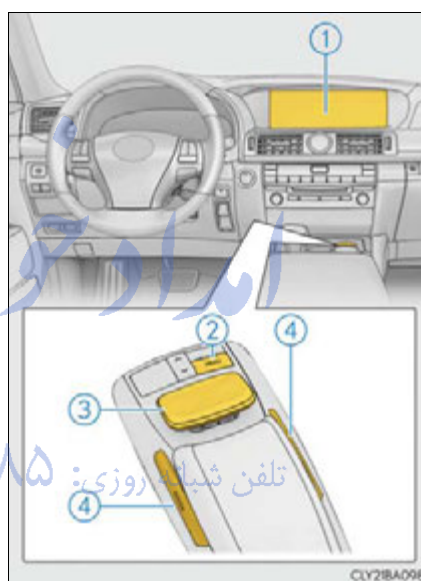

FarmaSOS.com

Trip information

Press the “MENU” button on the Remote Touch, then select  on the “Menu” screen, and then select “Fuel Consumption”.

If the “Past Record” screen is displayed, select “Trip Information”.

- ① Resetting the consumption data
- ② Fuel consumption in the past 15 minutes
- ③ Current fuel consumption
- ④ Average vehicle speed since the engine was started.
- ⑤ Elapsed time since the engine was started.
- ⑥ Cruising range (→P.105)



2

Instrument cluster

Average fuel consumption for the past 15 minutes is divided by color into past averages and averages attained since the engine switch was last turned to IGNITION ON mode. Use the displayed average fuel consumption as a reference.

The image is an example only, and may vary slightly from actual conditions.

Past record

Press the “MENU” button on the Remote Touch, then select  on the “Menu” screen, and then select “Fuel Consumption”.

If the “Trip Information” screen is displayed, select “Past Record”.

- ① Resetting the past record data
- ② Best recorded fuel consumption
- ③ Average fuel consumption
- ④ Previous fuel consumption record
- ⑤ Updating the average fuel consumption data



The average fuel consumption history is divided by color into past averages and the average fuel consumption since the last updated. Use the displayed average fuel consumption as a reference.

The image is an example only, and may vary slightly from actual conditions.

FarmaSOS.com

■ Updating the past record data

Update the average fuel consumption by selecting "Update" to measure the current fuel consumption again.

■ Resetting the data

The fuel consumption data can be deleted by selecting "Clear".

■ Cruising range

Displays the estimated maximum distance that can be driven with the quantity of fuel remaining.

This distance is computed based on your average fuel consumption.

As a result, the actual distance that can be driven may differ from that displayed.

امداد خودرو فارما

تلفن شبانه روزی: ۰۲۱-۸۸۸۶۲۰۸۵

FarmaSOS.com

Using the side display

Vehicle information can be displayed on the side display (→P. 332), then select “<” or “>” to select the desired screen.

▶ Fuel consumption

Displays the average fuel consumption for the past 10 minutes in 1 minute intervals, as well as the cruising range.

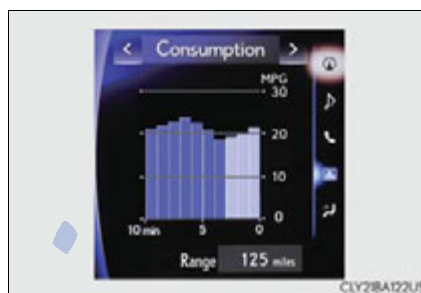

▶ Past record

Displays the average fuel consumption and highest fuel consumption.



▶ Trip information

Displays the cruising range, average fuel consumption and the amount of time elapsed since the engine was started.

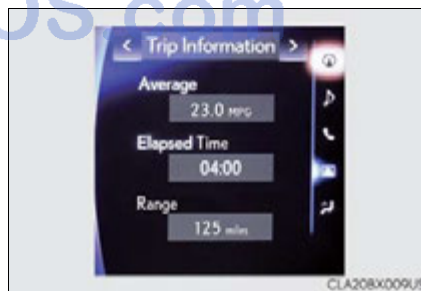

The image is an example only, and may vary slightly from actual conditions.

3-1. Key information	
Keys	108
3-2. Opening, closing and locking the doors and trunk	
Smart access system with push-button start.....	113
Wireless remote control	129
Doors	133
Trunk.....	137
3-3. Adjusting the seats	
Front seats.....	144
Power rear seat.....	150
Driving position memory	163
Rear seat position memory.....	168
Head restraints	170
3-4. Adjusting the steering wheel and mirrors	
Steering wheel	174
Inside rear view mirror.....	175
Outside rear view mirrors.....	177
3-5. Opening, closing the windows and moon roof	
Power windows	181
Moon roof.....	185

Keys

The keys

The following keys are provided with the vehicle.

- ① Electronic keys
 - Operating the smart access system with push-button start (→P. 113)
 - Operating the wireless remote control function (→P. 129)
- ② Mechanical keys
- ③ Key number plate
- ④ Card key (electronic key) (if equipped)
Operating the smart access system with push-button start (→P. 113)

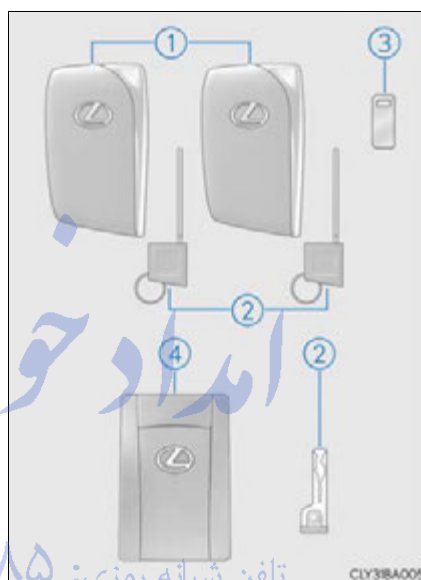

FarmaSOS.com

Using the mechanical key

To take out the mechanical key:

Electronic keys: Slide the release lever and take the key out.

Card key: Press the lock release button and take the key out.

The mechanical key can only be inserted in one direction, as the key only has grooves on one side. If the key cannot be inserted in a lock cylinder, turn it over and re-attempt to insert it.

After using the mechanical key, store it in the electronic key. Carry the mechanical key together with the electronic key. If the electronic key battery is depleted or the entry function does not operate properly, you will need the mechanical key.
(→P. 536)

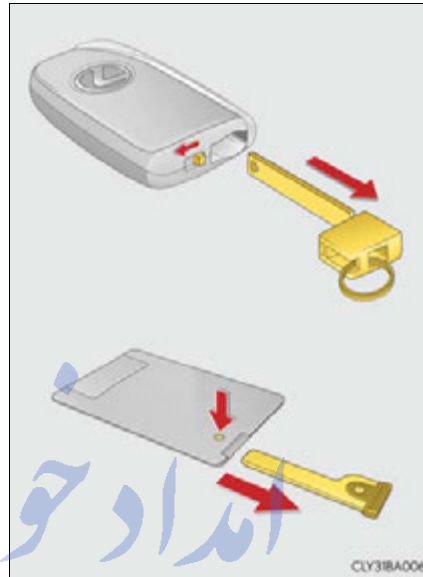

3

Operation of each component

FarmaSOS.com

■ Electronic keys

- Part of the electronic key uses leather. Refer to P. 432 for details on cleaning the leather portion.
- When cleaning the metallic portion, wet a cloth and firmly wring out any excess water from it, then thoroughly wipe off any dirt.
- When not using the electronic key for an extended period of time, store it in a dry place of normal temperature away from direct sunlight and interior light after removing any dirt.

■ Card key (if equipped)

- The card key is not waterproof.
- The mechanical key that is stored inside the card key should be used only if a problem arises, such as when the card key does not operate properly.
- If it is difficult to take out the mechanical key, push down the lock release button using a pen tip etc. If it is still difficult to pull it out, use a coin etc.
- To store the mechanical key in the card key, insert it while pressing the lock release button.



- If the battery cover is not installed and the battery falls out or if the battery was removed because the key got wet, reinstall the battery with the positive terminal facing the Lexus emblem.



■ When required to leave the vehicle's key with a parking attendant

Turn the trunk opener main switch off and lock the glove box and the trunk storage extension (if equipped) as circumstances demand. (→P. 138, 367, 409)

Remove the mechanical key for your own use and provide the attendant with the electronic key only.

■ If you lose your mechanical keys

New genuine mechanical keys can be made by your Lexus dealer using the other mechanical key and the key number stamped on your key number plate. Keep the plate in a safe place such as your wallet, not in the vehicle.

■ When riding in an aircraft

When bringing an electronic key onto an aircraft, make sure you do not press any buttons on the electronic key while inside the aircraft cabin. If you are carrying an electronic key in your bag etc., ensure that the buttons are not likely to be pressed accidentally. Pressing a button may cause the electronic key to emit radio waves that could interfere with the operation of the aircraft.

NOTICE

■ To prevent key damage

- Do not drop the keys, subject them to strong shocks or bend them.
- Do not expose the keys to high temperatures for a long period of time.
- Do not get the keys wet or wash them in an ultrasonic washer etc.
- Do not attach metallic or magnetic materials to the keys or place the keys close to such materials.
- Do not disassemble the keys.
- Do not attach a sticker or anything else to the surface of the electronic key.
- Do not place the keys near objects that produce magnetic fields, such as TVs, audio systems and induction cookers, or medical electrical equipment, such as low-frequency therapy equipment.

■ Handling the electronic keys

- Observe the following to prevent deterioration, changes in shape and damage to the leather area.
 - Do not carry the electronic key together with hard objects, such as other keys or accessories.
 - Do not expose the electronic keys to direct sunlight or interior light for extended periods of time.
 - Do not place the electronic key on items made of vinyl, plastic or that contain wax. They may stick to the leather surface if the items become warm.
 - Do not get the electronic key wet. Even if the electronic gets slightly wet, dry it with a soft cloth and let it dry in the shade.
 - Do not touch the electronic key with hands that have oil, medicine, hand cream or perfume on them.
 - When cleaning, do not use a leather cleaner, solvents or leather filling agents.
- Because the leather portion is dyed, if the electronic key touches clothing while it has sweat and moisture adhered to it, there is a possibility that the clothing may change color.

 NOTICE**■ In case of a smart access system with push-button start malfunction or other key-related problems**

Take your vehicle with all the electronic keys provided with your vehicle, including the card key to your Lexus dealer.

■ When an electronic key is lost

If the electronic key remains lost, the risk of vehicle theft increases significantly. Visit your Lexus dealer immediately with all remaining electronic keys and the card key that was provided with your vehicle.

■ Handling the card key

- Do not apply excess force when inserting the mechanical key into the card key. Doing so may damage the card key.
- If the battery or card key terminals get wet, the battery may corrode. If the key is dropped into water, or if drinking water etc. is spilled on the key, immediately remove the battery cover and wipe the battery and terminals. (To remove the battery cover, lightly grasp and pull it.) If the battery is corroded, have your Lexus dealer replace the battery.
- Do not crush the battery cover or use a screwdriver to remove the battery cover. Forcibly removing the battery cover may bend or damage the key.
- If the battery cover is frequently removed, the battery cover may become loose.
- When installing the battery, make sure to check the direction of the battery. Installing the battery in the wrong direction may cause the battery to deplete rapidly.
- The surface of the card key may be damaged, or its coating may peel off in the following situations:
 - The card key is carried together with hard objects, such as coins and keys.
 - The card key is scraped with a sharp object, such as the tip of a mechanical pencil.
 - The surface of the card key is wiped with thinner or benzene.

Smart access system with push-button start

Function summary

The following operations can be performed simply by carrying the electronic key (including the card key) on your person, for example in your pocket. (The driver should always carry the electronic key.)

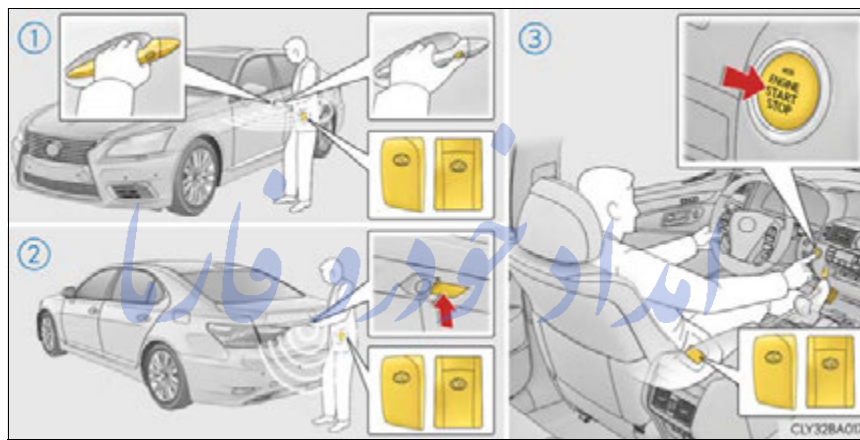

- ① Locks and unlocks the doors (→P. 115)
- ② Opens the trunk (→P. 115)
- ③ Starts the engine (→P. 208)

3

Operation of each component

FarmaSOS.com

■ Operation signals

Doors:

A buzzer sounds and the emergency flashers flash to indicate that the doors have been locked/unlocked. (Locked: Once; Unlocked: Twice)

Trunk:

A buzzer sounds to indicate that the trunk has been unlocked.

Windows and moon roof:

A buzzer sounds to indicate that the windows and moon roof are operating.

■ Security feature

If a door is not opened within approximately 60 seconds after the vehicle is unlocked, the security feature automatically locks the vehicle again.

■ Welcome light illumination control

The side marker, parking, tail and license plate lights automatically turn on at night when the doors are unlocked using the entry function or wireless remote control if the headlight switch is in the "AUTO" position.

تلفن شبانه روزی: ۰۲۱-۸۸۸۶۲۰۸۵

FarmaSOS.com

Unlocking and locking the doors

Grip the driver's door handle to unlock the door. Grip the passenger's door handle to unlock all the doors.*

Make sure to touch the sensor on the back of the handle.

The door cannot be unlocked for 3 seconds after the door is locked.

*: The door unlock settings can be changed. (→P.120)

Press the lock button to lock the door.

Check that the door is securely locked.

Pressing and holding the button closes the windows and moon roof.

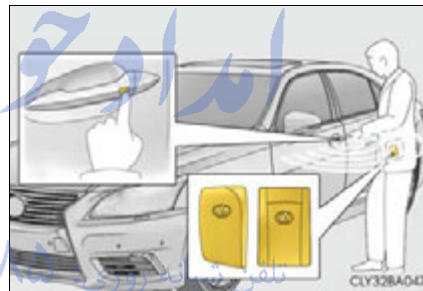

Opening the trunk

Press the button.

If the vehicle is equipped with power trunk opener and closer, the trunk lid automatically opens fully.

When all the doors are unlocked using one of the following methods, the trunk can be opened without the electronic key:

- Entry function
- Wireless remote control
- Door lock switches
- Automatic door unlocking system
- Mechanical key



Antenna location and effective range

■ Antenna location

- ① Antennas outside the cabin
- ② Antennas inside the cabin
- ③ Antenna outside the trunk
- ④ Antenna inside the trunk

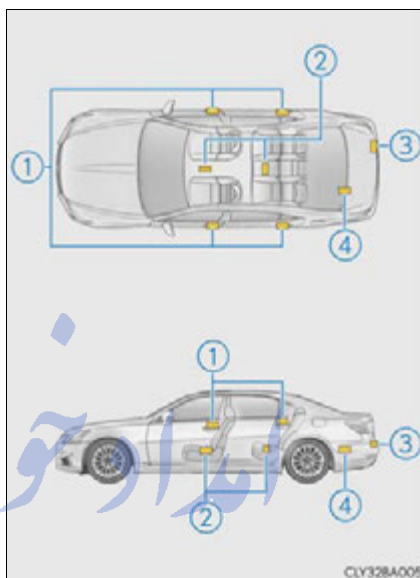

تلفن شبانه روزی: ۰۲۱-۸۸۸۶۲۰۸۵

FarmaSOS.com

■ **Effective range (areas within which the electronic key is detected)**

- When locking or unlocking the doors

The system can be operated when the electronic key is within about 2.3 ft. (0.7 m) of an outside door handle. (Only the doors detecting the key can be operated.)

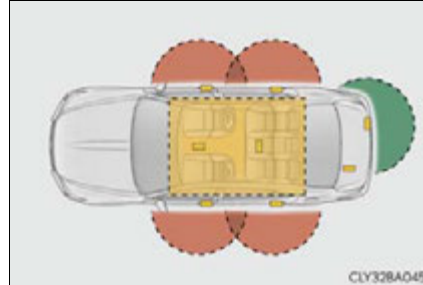

- When opening the trunk

The system can be operated when the electronic key is within about 2.3 ft. (0.7 m) of the trunk release button.

- When starting the engine or changing engine switch modes

The system can be operated when the electronic key is inside the vehicle.

تلفن شبانه روزی: ۰۲۱-۸۸۶۲۰۸۵

FarmaSOS.com

■ Alarms and warning indicators

A combination of exterior and interior alarms as well as warnings displayed on the multi-information display are used to prevent theft of the vehicle and unforeseeable accidents resulting from erroneous operation. Perform the appropriate correction procedure described in the following table:

Alarm	Situation	Correction procedure
Exterior alarm sounds once for 2 seconds.	An attempt was made to lock the doors using the entry function while the electronic key was still inside the passenger compartment.	Retrieve the electronic key from the passenger compartment and lock the doors again.
	The trunk was closed with the electronic key inside and all doors were locked.	Retrieve the electronic key from the trunk and close the trunk lid.
Exterior alarm sounds once for 60 seconds.	An attempt was made to exit the vehicle and lock the doors while carrying the electronic key without first turning the engine switch off.	Turn the engine switch off and lock the doors again.
Exterior alarm sounds once for 5 seconds.	An attempt was made to lock the vehicle while a door was open.	Close all of the doors and lock the doors again.
Interior alarm pings continuously.	The engine switch was turned to ACCESSORY mode while the driver's door was open (or the driver's door was opened while the engine switch was in ACCESSORY mode).	Turn the engine switch off and close the driver's door.
	The engine switch was turned off while the driver's door was open.	Close the driver's door.

Alarm	Situation	Correction procedure
Interior alarm sounds continuously.*1	When the engine switch is in IGNITION ON or ACCESSORY mode, an attempt was made to open the door and exit the vehicle, and the shift lever was not in P.	Shift the shift lever to P and turn the engine switch off.
Interior and exterior alarms sound continuously.*1	When the engine switch is in IGNITION ON or ACCESSORY mode, the driver's door was closed after the key was carried outside the vehicle, and the shift lever was not in P.	Shift the shift lever to P, turn the engine switch off and close the driver's door again.
Interior alarm pings once.*1	The electronic key has a low battery.	Replace the electronic key battery.
	An attempt was made to start the engine without the electronic key being present, or the electronic key was not functioning normally.	Start the engine with the electronic key present.*2
Interior alarm pings once and exterior alarm sounds 3 times.*1	The driver's door was closed after the key was carried outside the vehicle, and the engine switch was not turned off.	Turn the engine switch off and close the driver's door again.
	An occupant carried the electronic key outside the vehicle and closed the door while the engine switch was not off.	Bring the electronic key back into the vehicle.

*1: A warning message will be shown on the multi-information display in the instrument cluster.





*2: If the engine does not start when the electronic key is inside the vehicle, the electronic key battery may be depleted or there may be difficulties receiving the signal from the key. (→P. 122)

■ Switching the door unlock function

It is possible to set which doors the entry function unlocks using the wireless remote control.

- 1 Turn the engine switch off.
- 2 Press and hold  ,  or  for approximately 5 seconds while pressing and holding  .

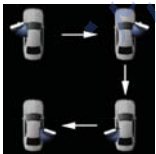
The setting changes each time an operation is performed, as shown below. (When changing the setting continuously, release the buttons, wait for at least 5 seconds, and repeat step 2.)

Multi-information display	Unlocking function	Beep
	Hold the driver's door handle to unlock only the driver's door.	Exterior: Beeps 3 times Interior: Rings once
	Hold a passenger's door handle to unlock all the doors.	Exterior: Beeps 4 times Interior: Rings once
	Hold the door handle to unlock the front and rear doors on your side.	Exterior: Beeps 4 times Interior: Rings once
	Hold the door handle to unlock the door.	Exterior: Beeps once Interior: Rings once
	Hold a door handle to unlock all doors.	Exterior: Beeps twice Interior: Rings once

To prevent unintended triggering of the alarm, unlock the doors using the wireless remote control and open and close a door once after the settings have been changed. (If a door is not opened within 60 seconds after  is pressed, the doors will be locked again and the alarm will automatically be set.)

In case that the alarm is triggered, immediately stop the alarm. (→P. 80)

■ Battery-saving function

In the following circumstances, the entry function is disabled in order to prevent the vehicle battery from discharging and electronic key battery from depleting.

- When the entry function has not been used for 30 days or more
- When the electronic key has been left within approximately 6 ft. (2 m) of the vehicle for 10 minutes or more

The system will resume operation when

- The vehicle is locked using the door handle lock switch when carrying the electronic key on your person.
- The vehicle is locked/unlocked using the wireless remote control function. (→P.129)
- The vehicle is locked/unlocked using the mechanical key. (→P.536)

3

Operation of each component

امداد خودرو فارما

تلفن شبانه روزی: ۰۲۱-۸۸۸۶۲۰۸۵

FarmaSOS.com

■ Conditions affecting operation

The smart access system with push-button start uses weak radio waves. In the following situations, the communication between the electronic key and the vehicle may be affected, preventing the smart access system with push-button start, wireless remote control and engine immobilizer system from operating properly.

(Ways of coping: →P. 536)

- When the electronic key battery is depleted
- Near a TV tower, electric power plant, gas station, radio station, large display, airport or other facility that generates strong radio waves or electrical noise
- When carrying a portable radio, cellular phone, cordless phone or other wireless communication device
- When the electronic key is in contact with, or is covered by the following metallic objects
 - Cards to which aluminum foil is attached
 - Cigarette boxes that have aluminum foil inside
 - Metallic wallets or bags
 - Coins
 - Hand warmers made of metal
 - Media such as CDs and DVDs
- When multiple electronic keys are in the vicinity
- When other wireless keys (that emit radio waves) are being used nearby
- When carrying the electronic key together with the following devices that emit radio waves
 - Another vehicle's electronic key or a wireless key that emits radio waves
 - Personal computers or personal digital assistants (PDAs)
 - Digital audio players
 - Portable game systems
- If window tint with a metallic content or metallic objects are attached to the rear window

■ Note for the entry function

- Even when the electronic key is within the effective range (detection areas), the system may not operate properly in the following cases:
 - The electronic key is too close to the window or outside door handle, near the ground, or in a high place when the doors are locked or unlocked.
 - The electronic key is near the ground or in a high place, or too close to the rear bumper center when the trunk is opened.
 - The electronic key is on the instrument panel, rear package tray or floor, or in the door pockets or glove box when the engine is started or engine switch modes are changed.
- Do not leave the electronic key on top of the instrument panel or near the door pockets when exiting the vehicle. Depending on the radio wave reception conditions, it may be detected by the antenna outside the cabin and the door will become lockable from the outside, possibly trapping the electronic key inside the vehicle.
- As long as the electronic key is within the effective range, the doors may be locked or unlocked by anyone. However, only the doors detecting the electronic key can be used to unlock the vehicle.
- Even if the electronic key is not inside the vehicle, it may be possible to start the engine if the electronic key is near the window.
- The doors may unlock if a large amount of water splashes on the door handle, such as in the rain or in a car wash when the electronic key is within the effective range. (The doors will automatically be locked after approximately 60 seconds if the doors are not opened and closed.)
- Gripping the door handle when wearing a glove may not unlock the door.
- If the wireless remote control is used to lock the doors when the electronic key is near the vehicle, there is a possibility that the door may not be unlocked by the entry function. (Use the wireless remote control to unlock the doors.)
- A sudden approach to the effective range or door handle may prevent the doors from being unlocked. In this case, return the door handle to the original position and check that the doors unlock before pulling the door handle again.

■ When the vehicle is not driven for extended periods

To prevent theft of the vehicle, do not leave the electronic key within 6 ft. (2 m) of the vehicle.

■ Alarm

Using the smart access system with push-button start to lock the doors will set the alarm system. (→P. 80)

■ To operate the system properly

- Make sure to carry the electronic key when operating the system. Do not get the electronic key too close to the vehicle when operating the system from the outside of the vehicle.

Depending on the position and holding condition of the electronic key, the key may not be detected correctly and the system may not operate properly. (The alarm may go off accidentally, or the door lock prevention function may not operate.)

- Do not leave the electronic key inside the trunk.
The key confinement prevention function may not operate, depending on the location of the key (close to a spare tire, the inside edge of the trunk), conditions (inside a metal bag, close to metallic objects) and the radio waves in the surrounding area. (→P. 139)

■ If the smart access system with push-button start does not operate properly

- Locking and unlocking the doors and trunk: Use the mechanical key. (→P. 536)
- Starting the engine: →P. 538

FarmaSOS.com

■ Electronic key battery depletion

- The standard battery life is 1 to 2 years. (The card key battery life is about a year and a half.)
- If the battery is low, an alarm will sound in the cabin when the engine is started or stopped. (→P. 118)
- The battery becomes depleted even if the electronic key is not used because the key always receives radio waves. If the smart access system with push-button start or the wireless remote control does not operate, or the detection area becomes smaller, the battery may be depleted. Replace the battery when necessary. (→P. 483)
- To avoid serious deterioration, do not leave the electronic key within 3 ft. (1 m) of the following electrical appliances that produce a magnetic field:
 - TVs
 - Personal computers
 - Cellular phones, cordless phones and battery chargers
 - Recharging cellular phones or cordless phones
 - Table lamps
 - Glass top ranges

■ When the electronic key battery is fully depleted

→P. 483

■ Customization

Settings (e. g. smart access system with push-button start) can be changed. (Customizable features →P. 577)

FarmaSOS.com

■ Certification for the smart access system with push-button start

- For vehicles sold in the U.S.A., Hawaii, Guam and Puerto Rico

FCC ID: NI4TMLF-4

This device complies with part 15 of the FCC Rules. Operation is subject to the following two conditions: (1) This device may not cause harmful interference; and (2) This device must accept any interference received, including interference that may cause undesired operation.

Changes or modifications not expressly approved by the party responsible for compliance could void the user's authority to operate the equipment.

- For vehicles sold in Canada

This device complies with Industry Canada licence-exempt RSSs. Operation is subject to the following two conditions: (1) This device may not cause interference; and (2) This device must accept any interference, including interference that may cause undesired operation of the device.

امداد خودرو فارما

تلفن شبانه روزی: ۰۲۱-۸۸۸۶۲۰۸۵

FarmaSOS.com

⚠ CAUTION**■ Caution regarding interference with electronic devices**

- People with implantable cardiac pacemakers, cardiac resynchronization therapy-pacemakers or implantable cardioverter defibrillators should keep away from the smart access system with push-button start antennas. (→P. 116)

The radio waves may affect the operation of such devices. If necessary, the entry function can be disabled. Ask your Lexus dealer for details, such as the frequency of radio waves and timing of the emitted radio waves. Then, consult your doctor to see if you should disable the entry function.

- Users of any electrical medical device other than implantable cardiac pacemakers, cardiac resynchronization therapy-pacemakers or implantable cardioverter defibrillators should consult the manufacturer of the device for information about its operation under the influence of radio waves.

Radio waves could have unexpected effects on the operation of such medical devices.

Ask your Lexus dealer for details on disabling the entry function.

■ When using the smart access system with push-button start and operating the power windows or moon roof

Operate the power window or moon roof after checking to make sure that there is no possibility of any passenger having any of their body parts caught in the window or moon roof. Also, do not allow children to operate the smart access system with push-button start. It is possible for children and other passengers to get caught in the power window or moon roof.

FarmaSOS.com

 NOTICE

■ When opening the trunk

Do not press the Lexus parking assist monitor system camera by mistake.
If the camera or surrounding area receives a strong impact, the camera may move off its installed position and/or angle.



امداد خودرو فارما

تلفن شبانه روزی: ۰۲۱-۸۸۸۶۲۰۸۵

FarmaSOS.com

Wireless remote control

Function summary

The wireless remote control can be used to lock and unlock the vehicle.

① Locks all the doors

Check that the door is securely locked.

② Unlocks all the doors

Pressing the button unlocks the driver's door. Pressing the button again within 3 seconds unlocks the other doors.

③ Opens the windows and moon roof (press and hold)*

④ Opens the trunk (press and hold)

If the vehicle is equipped with a power trunk opener and closer, the trunk lid automatically opens fully.

⑤ Sounds the alarm (press and hold) (→P. 130)

*: This setting must be changed using the customize function. (→P. 577)

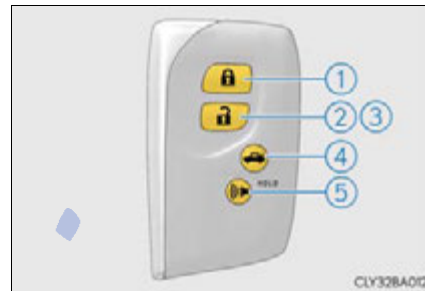

3

Operation of each component

■ Operation signals

Doors:

A buzzer sounds and the emergency flashers flash to indicate that the doors have been locked/unlocked. (Locked: once; Unlocked: twice)

Trunk:

A buzzer sounds to indicate that the trunk has been opened.

Windows and moon roof:

A buzzer sounds to indicate that the windows and moon roof are operating.

■ Welcome light illumination control

→P. 114

■ Door lock buzzer

If an attempt to lock the doors is made when a door is not fully closed, a buzzer sounds continuously for 5 seconds. Fully close the door to stop the buzzer, and lock the vehicle once more.

■ Panic mode

When  is pressed for longer than about one second, an alarm will sound intermittently and the vehicle lights will flash to deter any person from trying to break into or damage your vehicle.

To stop the alarm, press any button on the electronic key.



■ Security feature

→P. 114

■ Alarm

Using the wireless remote control to lock the doors will set the alarm system. (→P. 80)

■ Conditions affecting operation

→P. 122

■ If the wireless remote control does not operate properly

Locking and unlocking the doors the trunk: Use the mechanical key. (→P. 536)

■ Electronic key battery depletion

→P. 125

■ When the electronic key battery is fully depleted

→P. 483

■ Customization

Settings (e.g. wireless remote control system) can be changed.
(Customizable features →P. 577)

■ Certification for wireless remote control

► For vehicles sold in Hawaii, Guam and Puerto Rico

FCC ID: NI4TMRF-002

FCC ID: HYQ14ACX

FCC ID: HYQ14AEB

NOTE:

This device complies with part 15 of the FCC Rules. Operation is subject to the following two conditions: (1) This device may not cause harmful interference, and (2) this device must accept any interference received, including interference that may cause undesired operation.

FCC WARNING:

Changes or modifications not expressly approved by the party responsible for compliance could void the user's authority to operate the equipment.

FarmaSOS.com

- ▶ For vehicles sold in the mainland U.S.A.

FCC ID: NI4TMRF-002

FCC ID: HYQ14ACX

FCC ID: HYQ14AEB

FCC ID: NI4TMRF-001

FCC ID: HYQ14ADF

FCC ID: HYQ14AEF

NOTE:

This device complies with part 15 of the FCC Rules. Operation is subject to the following two conditions: (1) This device may not cause harmful interference, and (2) this device must accept any interference received, including interference that may cause undesired operation.

FCC WARNING:

Changes or modifications not expressly approved by the party responsible for compliance could void the user's authority to operate the equipment.

- ▶ For vehicles sold in Canada

NOTE:

This device complies with Industry Canada's licence-exempt RSSs.

Operation is subject to the following two conditions:

(1) This device may not cause interference; and

(2) This device must accept any interference, including interference that may cause undesired operation of the device.

FarmaSOS.com

Doors

Unlocking and locking the doors

The vehicle can be locked and unlocked using the entry function, wireless remote control or door lock switches.

◆ Entry function

→P. 113

◆ Wireless remote control

→P. 129

◆ Door lock switches

- ① Locks all the doors
- ② Unlocks all the doors

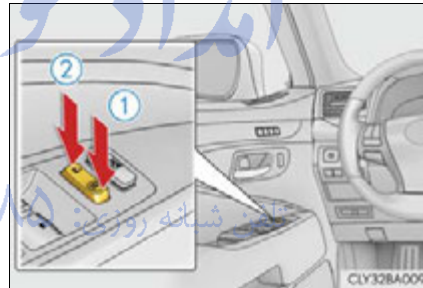

◆ Inside lock buttons

- ① Locks the door
- ② Unlocks the door

The front doors can be opened by pulling the inside handle even if the lock buttons are in the lock position.

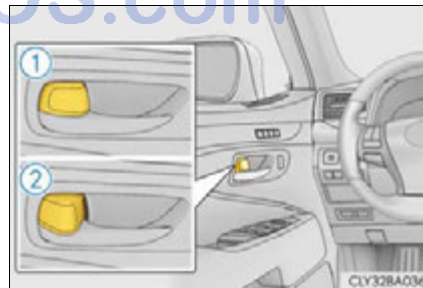

3

Operation of each component

Locking the front doors from the outside without a key

- 1 Move the inside lock button to the lock position.
- 2 Close the door.

The door cannot be locked if the engine switch is in ACCESSORY or IGNITION ON mode, or the electronic key is left inside the vehicle.

The key may not be detected correctly and the door may be locked.

Rear door child-protector lock

The door cannot be opened from inside the vehicle when the lock is set.

- 1 Unlock
- 2 Lock

These locks can be set to prevent children from opening the rear doors. Push down on each rear door switch to lock both rear doors.

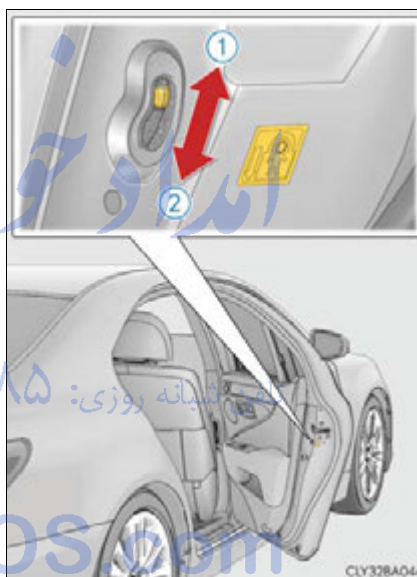

Automatic door locking and unlocking systems

The following functions can be set or canceled:

For instructions on customizing, refer to P. 577.

Function	Operation
Speed linked door locking function	All doors are automatically locked when vehicle speed is approximately 12 mph (20 km/h) or higher.
Shift position linked door locking function	All doors are automatically locked when shifting the shift lever to position other than P.
Shift position linked door unlocking function	All doors are automatically unlocked when shifting the shift lever to P.
Driver's door linked door unlocking function	All doors are automatically unlocked when driver's door is opened.

■ Impact detection door lock release system

In the event that the vehicle is subject to a strong impact, all the doors are unlocked. Depending on the force of the impact or the type of accident, however, the system may not operate.

■ Door closer

In the event that a door is left slightly open, the door closer will automatically close it to the fully closed position.

- The door closer will operate regardless of the engine switch mode.
- The door closer will not function if the door has been closed while pulling the inside or outside door handle.
- The door can be opened by pulling the inside or outside door handle, even when the door closer is operating (except when the lock button is in the lock position or the child-protector lock is set).
- The motor sound may be heard for several seconds after the door closer closes the door. This does not indicate a malfunction.

■ Using the mechanical key

The doors can also be locked and unlocked with the mechanical key. (→P. 536)

■ If a wrong key is used

The key cylinder rotates freely to isolate inside mechanism.

■ Customization

Settings (e.g. unlocking function using a key) can be changed.
(Customizable features →P. 577)

⚠ CAUTION**■ To prevent an accident**

Observe the following precautions while driving the vehicle.
Failure to do so may result in a door opening and an occupant throwing out of the vehicle, resulting in death or serious injury.

- Ensure that all doors are properly closed and locked.
- Do not pull the inside handle of the doors while driving.
Be especially careful for the front doors, as the doors may be opened even if the inside lock buttons are in locked position.
- Set the rear door child-protector locks when children are seated in the rear seats.

■ Door closer

In the event that a door is left slightly open, the door closer will automatically close it to the fully closed position.

If the child-protector lock is set, the door closer will not stop during operation even if an attempt is made to open the door from inside the vehicle. Be careful not to catch fingers or anything else in the door. Failure to do so may result in serious injury.

⚠ NOTICE**■ To prevent door closer malfunction**

Do not frequently repeat opening and closing of doors, or apply excessive force to a door while the door closer is operating.

Trunk

The trunk can be opened using the trunk opener, entry function or wireless remote control.

If the vehicle is equipped with a power trunk opener and closer, the trunk can be closed using the trunk closer.

Opening the trunk from inside the vehicle

Press the opener switch.

If the vehicle is equipped with a power trunk opener and closer, the trunk lid automatically opens fully.

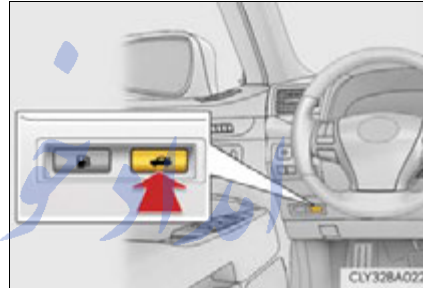

Opening the trunk from outside the vehicle

- Entry function

→P. 113

- Wireless remote control

→P. 129

3

Operation of each component

Trunk closer switch (vehicles with power trunk opener and closer)

Pressing the switch closes the trunk lid automatically. (A buzzer sounds.)

Pressing the switch while the trunk lid is closing opens the trunk lid again.



When closing the trunk

Using the trunk grip, lower the trunk without applying force to the side and push the trunk down from the outside to close it.



Luggage security system

The trunk opener switch can be temporarily disabled to protect luggage stored in the trunk against theft.

Turn the main switch in the glove box off to disable the trunk opener.

- ① On
- ② Off

The trunk lid cannot be opened even with the wireless remote control or the entry function.

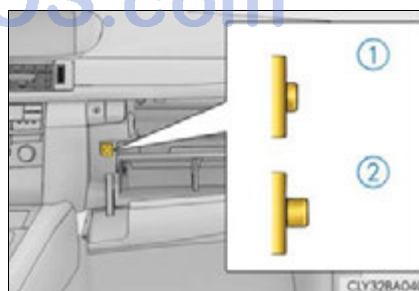

■ Trunk lid light/trunk light

The trunk lid light/trunk light turns on when the trunk is opened.

■ Trunk easy closer

In the event that the trunk lid is left slightly open, the trunk easy closer will automatically close it to the fully closed position.

■ Function to prevent the trunk being locked with the electronic key inside (when all the doors are locked)

Closing the trunk lid with the electronic key left inside the trunk will sound an alarm. In this case, the trunk lid can be opened by pressing the button on the trunk lid.

■ Overload protection function (vehicles with power trunk opener and closer)

The trunk lid will not operate when excessive load is present on the top of the trunk lid.

■ Fall-down protection function (vehicles with power trunk opener and closer)

While the trunk lid is opening automatically, applying excessive force to it will stop the opening operation to prevent the trunk lid from rapidly falling down.

■ Jam protection function (vehicles with power trunk opener and closer)

While the trunk lid is closing automatically, the trunk lid will stop closing and open if something gets caught.

■ Internal trunk release lever

The trunk lid can be opened by pulling the glow-in-the-dark lever located on the inside of the trunk lid to the side.

The lever will continue to glow for some time after the trunk lid is closed.



■ Using the mechanical key

The trunk can be also opened using the mechanical key. (→P. 537)

■ When leaving a key to the vehicle with a parking attendant

→P. 110

⚠ CAUTION

Observe the following precautions.
Failure to do so may result in death or serious injury.

■ Before driving

- Make sure that the trunk lid is fully closed. If the trunk lid is not fully closed, it may open unexpectedly while driving and hit near-by objects or luggage in the trunk may be thrown out, causing an accident.
- Do not allow children to play in the trunk.
If a child is accidentally locked in the trunk, they could suffer from heat exhaustion, suffocation or other injuries.
- Do not allow a child to open or close the trunk lid.
Doing so may cause the trunk lid to open unexpectedly, or cause the child's hands, head, or neck to be caught by the closing trunk lid.

■ Important points while driving

Never let anyone sit in the trunk. In the event of sudden braking or a collision, they are susceptible to death or serious injury.

تلفن شبانه روزی: ۰۲۱-۸۸۸۶۲۰۸۵

FarmaSOS.com

⚠ CAUTION

■ Using the trunk

Observe the following precautions.

Failure to do so may cause parts of the body to be caught, resulting in serious injury.

- Remove any heavy loads, such as snow and ice, from the trunk lid before opening it. Failure to do so may cause the trunk lid to suddenly shut again after it is opened.
- When opening or closing the trunk lid, thoroughly check to make sure the surrounding area is safe.
- If anyone is in the vicinity, make sure they are safe and let them know that the trunk is about to open or close.
- Use caution when opening or closing the trunk lid in windy weather as it may move abruptly in strong wind.
- The trunk lid may suddenly shut if it is not opened fully. It is more difficult to open or close the trunk lid on an incline than on a level surface, so beware of the trunk lid unexpectedly opening or closing by itself. Make sure that the trunk lid is fully open and secure before using the trunk.
- When closing the trunk lid, take extra care to prevent your fingers etc. from being caught.
- When closing the trunk lid, make sure to press it lightly on its outer surface. If the trunk handle is used to fully close the trunk lid, it may result in hands or arms being caught.
- Do not attach any accessories other than genuine Lexus parts to the trunk lid. Such additional weight on the trunk lid may cause the lid to suddenly shut again after it is opened.



CAUTION

■ **Trunk easy closer**

In the event that the trunk lid is left slightly open, the trunk easy closer will automatically close it to the fully closed position. It takes several seconds before the trunk easy closer begins to operate. Be careful not to catch fingers or anything else in the trunk lid, as this may cause bone fractures or other serious injuries.



■ **Power trunk opener and closer (if equipped)**

Observe the following precautions when operating the power trunk opener and closer.

Failure to do so may cause serious injury.

- Check the safety of the surrounding area to make sure there are no obstacles or anything that could cause any of your belongings to get caught.
- If anyone is in the vicinity, make sure they are safe and let them know that the trunk is about to open or close.
- If the trunk closer switch is pressed while the trunk lid is opening during automatic operation, the trunk lid stops opening. Take extra care when on an incline, as the trunk lid may open or close suddenly.
- On an incline, the trunk lid may suddenly shut after it opens automatically. Make sure the trunk lid is fully open and secure before using the trunk.
- In the following situations, the power trunk opener and closer may detect an abnormality and automatic operation may be stopped. In this case, the trunk lid has to be operated manually. Take extra care in this situation, as the stopped trunk lid may suddenly shut, causing an accident.
 - When the trunk lid contacts an obstacle
 - When the battery voltage suddenly drops, such as when the engine switch is turned to IGNITION ON mode or the engine is started during automatic operation
- Do not attach any accessories other than genuine Lexus parts to the trunk lid. The power trunk opener and closer may not operate, causing itself to malfunction, or the trunk lid may suddenly shut again after it is opened.

⚠ CAUTION**■ Jam protection function**

Observe the following precautions.
Failure to do so may cause serious injury.

- Never use any part of your body to intentionally activate the jam protection function.
- The jam protection function may not work if something gets caught just before the trunk lid fully closes. Be careful not to catch fingers or anything else in the trunk lid.
- The jam protection function may not work depending on the shape of the object that is caught. Be careful not to catch fingers or anything else.

⚠ NOTICE**■ To prevent trunk easy closer malfunctions**

Do not apply force to the trunk lid while the trunk easy closer is operating.

■ To prevent damage to the power trunk opener and closer (vehicles with power trunk opener and closer)

- Make sure that there is no luggage or snow on the trunk lid before operating the power trunk opener and closer. In addition, make sure that there is no ice between the trunk lid and frame that prevents movement of the trunk lid. Operating the power trunk opener and closer when excessive load is present on the trunk lid may cause a malfunction.
- Do not apply excessive force to the trunk lid while the power trunk opener and closer is operating.

3

Operation of each component

Front seats

Adjustment procedure

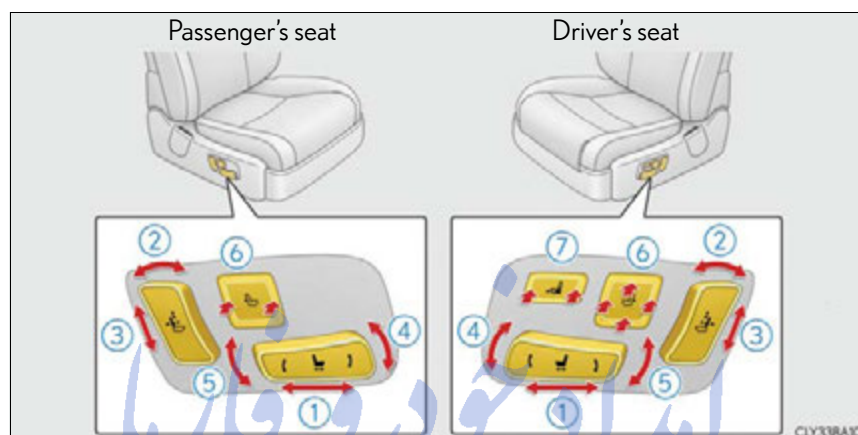

① Seat position adjustment switch

The height of the driver's head restraint is automatically adjusted simultaneously with the seat position adjustment operation.

② Seatback angle adjustment switch

③ Head restraint height adjustment switch (→P. 170)

④ Seat cushion (front) angle adjustment switch

⑤ Vertical height adjustment switch

⑥ Lumbar/pelvic support adjustment switch

Driver's seat: firmness, vertical, backward and forward positioning

Front passenger's seat: firmness, backward and forward positioning

⑦ Seat cushion length adjustment switch

Operating the front passenger's seat from the driver's seat

► Vehicles without relaxation seat

- ① Tilts the seatback forward
- ② Tilts the seatback backward
- ③ Moves the seat forward
- ④ Moves the seat backward



► Vehicles with relaxation seat

- ① Tilts the seatback forward and moves the seat forward
- ② Tilts the seatback backward and moves the seat backward

If the rear seat is not in the neutral position, pressing the button once will move the rear seat to the neutral position. Pressing the button again will move the front passenger's seat to the neutral position.

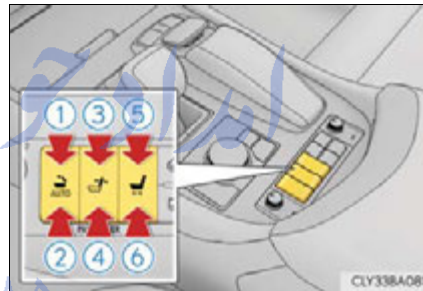

- ③ Tilts the seatback forward
- ④ Tilts the seatback backward
- ⑤ Moves the seat forward
- ⑥ Moves the seat backward

3

Operation of each component

Operating the front passenger's seat from the rear seat (vehicles with relaxation seat)

► 5-seat models

- ① Moves the front passenger's seat forward

The signal beeps when the seat operation stops at the forward limit.

- ② Moves the front passenger's seat backward

The seatback will return to the neutral position. If the head restraint is folded, it will rise before the seatback moves.



► 4-seat models

- ① Moves the front passenger's seat forward

The signal beeps when the seat operation stops at the forward limit.

- ② Moves the front passenger's seat backward

The seatback will return to the neutral position. If the head restraint is folded, it will rise before the seatback moves.



Power easy access system

The seat and steering wheel are automatically adjusted to allow the driver or front passenger to enter and exit the vehicle easily.

■ Driver's seat

When all of the following have been performed, the driver's seat and steering wheel are automatically adjusted to a position that allows driver to enter and exit the vehicle easily.

- The shift lever has been shifted to P.
- The engine switch has been turned off.
- The driver's seat belt has been unfastened.

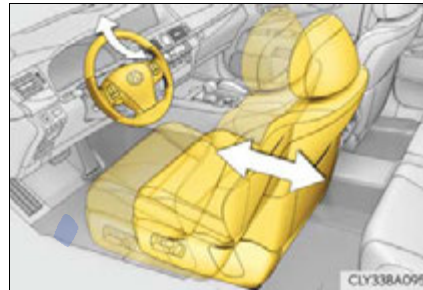

When any of the following has been performed, the driver's seat and steering wheel automatically return to their original positions.

- The engine switch has been turned to ACCESSORY mode.
- The driver's seat belt has been fastened.

■ Front passenger's seat

If the front passenger's door is opened while the vehicle is stopped, the adjusted lumbar/pelvic support, etc. will return to its original position.

■ Operating the front passenger's seat from the rear seat (vehicles with relaxation seat)

The front passenger's seat can be operated when the engine switch is in IGNITION ON mode. However, in the following situations, the front passenger's seat does not move even when the switch is operated:

- The weight of an occupant or heavy object etc. is detected on the front passenger's seat.
- The front passenger's seat belt is fastened.
- The front passenger's door is open. (The front seat will not move forward.)

■ Seat cushion automatic length adjustment (driver's seat)

If the front of the cushion gets too close to the area around the instrument panel when the seat position is being adjusted, the seat cushion will automatically retract.

■ Seat operation automatic stop function (vehicles with relaxation seat)

If a front seat is likely to come into contact with the retractable table (4-seat models) or the ottoman during seat operation or activation of the power easy access system, a buzzer will sound and seat slide operation will be stopped partway. (A warning message will be shown on the multi-information display.)

■ Power easy access system operations

- When exiting the vehicle, the power easy access system may not operate if the seat is already close to the rearmost position, etc.
- If the seat position is adjusted during the power easy access system operation, the operation will stop.
- If the seat position is adjusted during or after the power easy access system operation when the driver is exiting the vehicle, the power easy access system will not operate when entering the vehicle.

■ Customization

The distance that the driver's seat moves backward during the power easy access system can be changed. (Customizable features →P. 577)

⚠ CAUTION**■ When adjusting the seat position**

- Take care when adjusting the seat position to ensure that other passengers are not injured by the moving seat.
- Do not put your hands under the seat or near the moving parts to avoid injury. Fingers or hands may become jammed in the seat mechanism.

■ Seat adjustment

To reduce the risk of sliding under the lap belt during a collision, do not recline the seat more than necessary.

If the seat is too reclined, the lap belt may slide past the hips and apply restraint forces directly to the abdomen, or your neck may contact the shoulder belt, increasing the risk of death or serious injury in the event of an accident.

Adjustments should not be made while driving as the seat may unexpectedly move and cause the driver to lose control of the vehicle.

■ Operating the front passenger's seat from the driver's seat or rear seat

Do not operate the front passenger's seat when a passenger is seated in it. In addition, do not let anyone sit down in the front passenger's seat while the seat is being operated or when the head restraint is being folded. The front passenger may catch their legs between the instrument panel and seat, or the head restraint may interfere with their head, resulting in injury.

■ When adjusting the seat positions

Make sure to leave enough space around the feet so they do not get stuck.

3

Operation of each component

⚠ NOTICE**■ Operating the front passenger's seat from the driver's seat or rear seat**

Before operating the front passenger's seat, make sure that there is no luggage or any other objects on the seat or in the footwell that could prevent its operation.

Failure to do so may result in excess force being applied, causing damage to the seat and/or the luggage.

Power rear seat*

- ▶ 5-seat models without relaxation seat

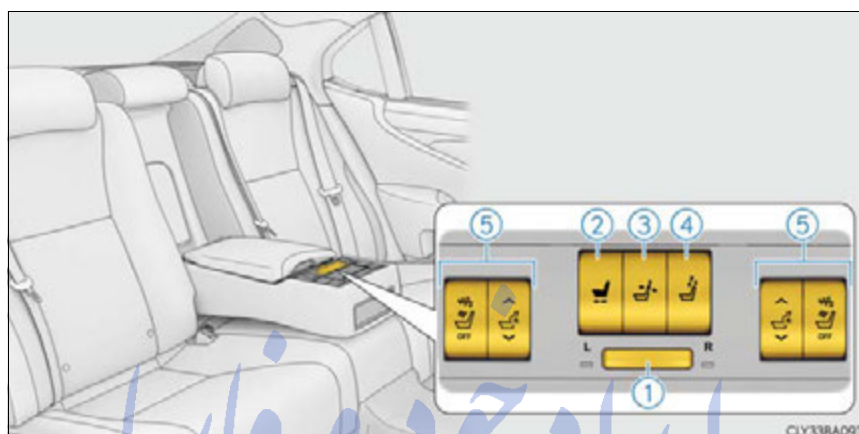

- ① Seat selection switch

The indicator light for the seat that can be operated comes on.

- ② Seat position adjustment switch
 ③ Seatback upper angle adjustment switch
 ④ Head restraint height adjustment switch (→P.170)
 ⑤ Pelvic support seat switches

FarmaSOS.com

*: If equipped

▶ 5-seat models with relaxation seat

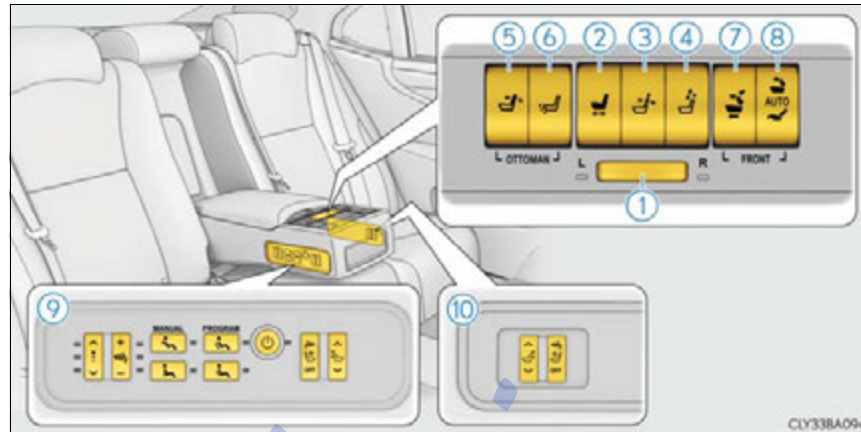

The right-hand rear seat is a relaxation seat, which is equipped with a seat-back angle adjustment function and an ottoman.

- ① Seat selection switch
The indicator light for the seat that can be operated comes on.
- ② Seat position adjustment switch
- ③ Seatback upper angle adjustment switch
- ④ Head restraint height adjustment switch (→P.170)
- ⑤ Seatback angle adjustment switch
- ⑥ Ottoman angle adjustment switch
- ⑦ Front passenger's seat control switch (→P.146)
- ⑧ Relaxation mode switch
- ⑨ Rear seat relaxation system/pelvic support seat switches
- ⑩ Pelvic support seat switches

► 4-seat models

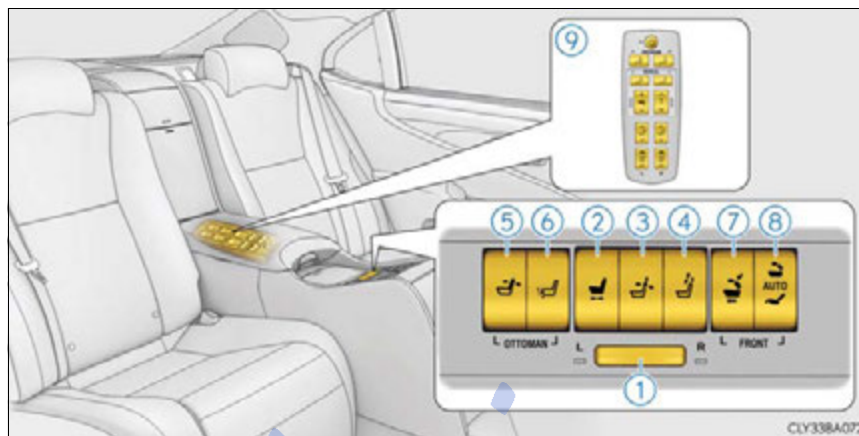

The right-hand rear seat is a relaxation seat, which is equipped with a seat-back angle adjustment function and an ottoman.

- ① Seat selection switch
The indicator light for the seat that can be operated comes on.
- ② Seat position adjustment switch
- ③ Seatback upper angle adjustment switch
- ④ Head restraint height adjustment switch (→P.170)
- ⑤ Seatback angle adjustment switch
- ⑥ Ottoman angle adjustment switch
- ⑦ Front passenger's seat control switch (→P.146)
- ⑧ Relaxation mode switch
- ⑨ Rear seat relaxation system/pelvic support seat controller

Seat return function linked to the door opening operation

The seat will return to the neutral position automatically when the door is opened for easier entry and exit of the vehicle.

Returning the rear seat from the front seats

► Vehicles without relaxation seat

The seat will return to the neutral position while the button is pressed and held.

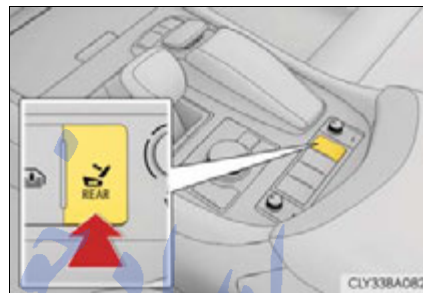

► Vehicles with relaxation seat

The seat will return to the neutral position while the button is pressed and held.

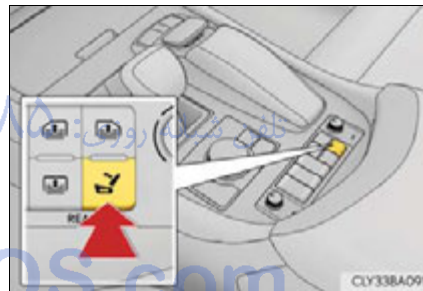

Relaxation mode operation (relaxation seat)

Relaxation mode can be entered by operating a switch. The front passenger seat will move forward, and then the seatback of the relaxation seat will recline and the ottoman will simultaneously rise.

► 5-seat models

Pressing the switch will cause a beep to sound and operation will start.

- ① Enters relaxation mode
- ② Returns to the neutral position

To stop the operation part-way through, press either side of the switch again, or press any other seat adjustment button.



► 4-seat models

Pressing the switch will cause a beep to sound and operation will start.

- ① Enters relaxation mode
- ② Returns to the neutral position

To stop the operation part-way through, press either side of the switch again, or press any other seat adjustment button.



Pelvic support seat with seat vibrator

Pelvic support seat with seat vibrator, which features a support plate mounted in the seatback and a vibration function, is equipped on each outer rear seat. The support plate position and vibration speed can be adjusted according to the occupant's preferences.

► 5-seat models without relaxation seat



- ① Support plate position adjustment switch
- ② Vibration switch

Press to operate the vibration function. Vibration will start in the same speed level as when previously operated. Each time is pressed, the speed changes between 3 levels. Pressing "OFF" stops the vibration function.

► 5-seat models with relaxation seat

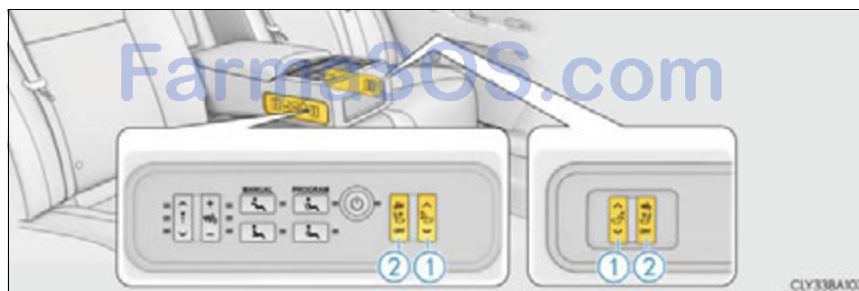



- ① Support plate position adjustment switch
- ② Vibration switch

Press to operate the vibration function. Vibration will start in the same speed level as when previously operated. Each time is pressed, the speed changes between 3 levels. Pressing "OFF" stops the vibration function.

► 4-seat models

① Support plate position adjustment switch

② Vibration switch

Press  to operate the vibration function. Vibration will start in the same speed level as when previously operated. Each time  is pressed, the speed changes between 3 levels. Pressing "OFF" stops the vibration function.

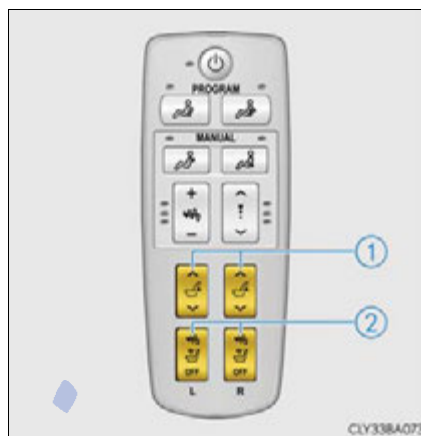

امداد خودرو فارما

تلفن شبانه روزی: ۰۲۱-۸۸۸۶۲۰۸۵



FarmaSOS.com

Rear seat relaxation system (vehicles with relaxation seat)

Pneumatic chambers built into the right-hand rear seat provide the occupant with pressure of different speeds and intensities.

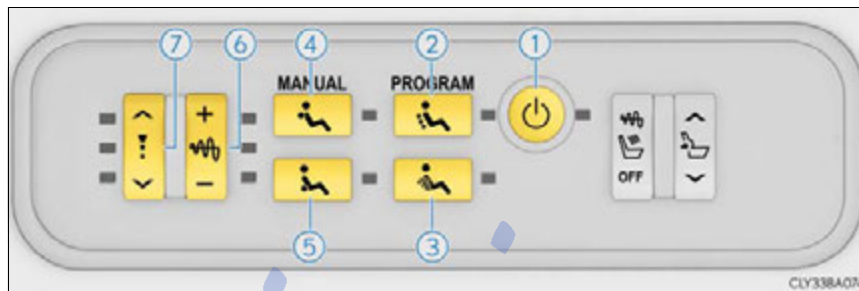
► 5-seat models





- | | |
|---|---|
| <p>① Turns the system on and off
If no buttons are selected within approximately 3 minutes of operating this switch, the system will automatically turn off.</p> <p>② Starts the  program
Partial pressure for the whole back</p> <p>③ Starts the  program
Stretches and relaxes the lower back</p> | <p>④ Starts operation for the upper back</p> <p>⑤ Starts operation for the lower back</p> <p>⑥ Adjusts the intensity of the air pressure
3 intensity levels are available.</p> <p>⑦ Adjusts the speed of the air unit
3 speed levels are available.</p> |
|---|---|

3

Operation of each component

FarmaSOS.com

► 4-seat models

- ① Turns the system on and off
If no buttons are selected within approximately 3 minutes of operating this switch, the system will automatically turn off.
- ② Starts the  program
Partial pressure for the whole back
- ③ Starts the  program
Stretches and relaxes the lower back
- ④ Starts operation for the upper back
- ⑤ Starts operation for the lower back
- ⑥ Adjusts the intensity of the air pressure
3 intensity levels are available.
- ⑦ Adjusts the speed of the air unit
3 speed levels are available.

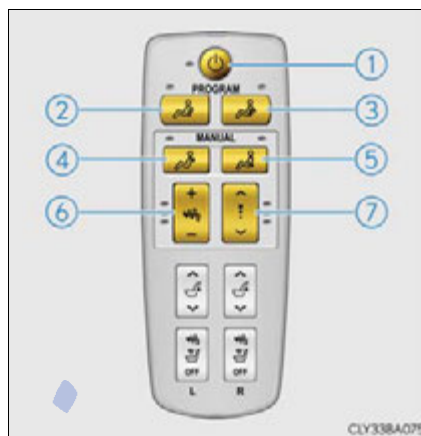

امداد خودرو فارما

تلفن شبانه روزی: ۰۲۱-۸۸۶۲۰۸۵

FarmaSOS.com

■ Seat return function linked to the door opening operation

- Operating conditions
The engine switch is in IGNITION ON mode.
- Canceling operation partway through
During the seat return operation, performing either of the following actions cancels the operation:
 - Pressing the "SET", "M" or "C" button (→P.168)
 - Pressing any of the seat adjustment switches
- Disabling the seat return function
Pressing the "C" button will disable the seat return function.
The indicator light comes on when the seat return function is disabled.
Pressing the button again will enable the seat return function.
- Seat return operation after turning the engine switch off
The seat will automatically return to the neutral position if the door is opened within approximately 45 seconds of the engine switch being turned off.

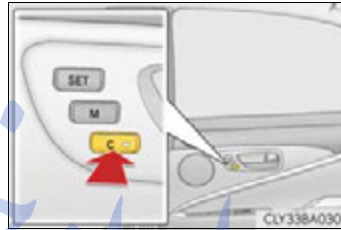

■ Relaxation mode (relaxation seat)

- Operating conditions
Relaxation mode can be entered when the engine switch is in IGNITION ON mode. However, in the following situations, relaxation mode cannot be entered even when the switch is operated:
 - The weight of an occupant or heavy object etc. is detected on the front passenger's seat.
 - The front passenger's seat belt is fastened.
 - The front passenger's door is open. (The front seat will not move forward.)
- Operation after turning the engine switch off
The rear seat can be returned to the neutral position as long as the relaxation mode switch is operated within approximately 45 seconds of the engine switch being turned off.

■ Pelvic support seat with seat vibrator

- Operating conditions
The engine switch is in IGNITION ON mode.
- Automatic stop function
 - Vibration will automatically stop approximately 15 minutes after starting.
 - Vibration will automatically stop if the adjacent rear door is opened.
- Pelvic support seat return function
The position of the support plate will automatically return to the neutral position if the adjacent rear door is opened.

■ Rear seat relaxation system (vehicles with relaxation seat)

- Operating conditions
The engine switch is in IGNITION ON mode.
- Automatic stop function
Each operation will automatically stop approximately 15 minutes after starting.

امداد خودرو فارما

تلفن شبانه روزی: ۰۲۱-۸۸۸۶۲۰۸۵

FarmaSOS.com

 CAUTION

■ Power rear seats
● Seat adjustment

To reduce the risk of sliding under the lap belt during a collision, do not recline the seat more than necessary.

If the seat is too reclined, the lap belt may slide past the hips and apply restraint forces directly to the abdomen, or your neck may contact the shoulder belt, increasing the risk of death or serious injury in the event of an accident.

Adjustments should not be made while driving as the seat may unexpectedly move and cause the driver to lose control of the vehicle.

● When adjusting the seat position and ottoman angle (vehicles with relaxation seat)

Keep sufficient footwell space to prevent your feet from being caught by the front seat.

● When returning the rear seats to the neutral position

To avoid injuring the rear passengers, wait until they have gotten out of the vehicle before operating the switch.

● Using the ottoman (vehicles with relaxation seat)

- Do not sit on the ottoman.

If someone sits on the ottoman, the seat belt cannot be fitted properly, and they may be thrown from the seat, resulting in death or serious injury in the event of an accident or sudden braking.

- When getting in or out of the vehicle, retract the ottoman. If the ottoman is not retracted, it may cause a fall, resulting in injury.

- Do not operate the ottoman when the vehicle is moving.

- Do not allow anyone to put their hands or feet under the passenger seat when stowing the ottoman.

■ Using the pelvic support seat with seat vibrator and rear seat relaxation system

- Those who are pregnant, have recently given birth, or suffer from ailments requiring rest (heart disease etc.) should consult a doctor before use.

- Do not allow children to use the pelvic support seat vibration function or the rear seat relaxation function.

- Do not use immediately after consuming a meal or alcohol, or for an extended period of time.

- If you feel sick while using the pelvic support seat vibration function or the rear seat relaxation function, immediately discontinue use.

 NOTICE**■ To prevent an ottoman malfunction (vehicles with relaxation seat)**

- Do not place any objects in the rear seat footwell that could prevent the operation of the ottoman.
- Do not place heavy luggage on the ottoman.
- Do not place any objects under the ottoman while it is raised for use. These objects may interfere with the ottoman being folded, causing damage to the ottoman or the objects themselves.

امداد خودرو فارما

تلفن شبانه روزی: ۰۲۱-۸۸۸۶۲۰۸۵

FarmaSOS.com

Driving position memory

This feature automatically adjusts the front seats, steering wheel, outside rear view mirrors and height of seat belt shoulder anchor to suit your preferences.

Driving position memory

Your preferred driving position (the position of the driver's seat, steering wheel, outside rear view mirrors and height of seat belt shoulder anchor) can be recorded and recalled by pressing a switch.

Three different driving positions can be recorded into memory.

■ Recording procedure

- 1 Check that the shift lever is in P.
- 2 Turn the engine switch to IGNITION ON mode.
- 3 Adjust the driver's seat, steering wheel, outside rear view mirrors and seat belt shoulder anchor height to the desired positions.
- 4 Press the "SET" switch, then within 3 seconds press switch "1", "2" or "3" until the signal beeps.

If the selected switch has already been preset, the previously recorded position will be overwritten.



To record the position of the front passenger's seat, adjust the front passenger's seat to the desired position and perform step 4 using the switches on the front passenger's side.

3

Operation of each component

■ **Recall procedure**

- 1 Check that the shift lever is in P.
- 2 Turn the engine switch to IGNITION ON mode.
- 3 Press one of the switches for the driving position you want to recall until the buzzer sounds.



■ **When you want to stop the position recall operation part-way through**

Perform any of the following operations:

- Press the "SET" switch.
- Press switch "1", "2" or "3".
- Operate any of the seat adjustment switches (only cancels seat position recall).
- Operate the tilt and telescopic steering control switch (only cancels steering wheel position recall).
- Operate the seat belt shoulder anchor height adjusting switch (only cancels height of seat belt shoulder anchor recall).

■ **Front passenger's seat position recall limitations (vehicles with relaxation seat)**

When retractable table (4-seat models) or ottoman is used, rearward memories cannot be recalled.

■ **Operating the driving position memory after turning the engine switch off**

Driver's seat:

Recorded driving positions (except the steering wheel position) can be recalled up to 180 seconds after the driver's door is opened and up to 60 seconds after it is closed again.

Front passenger's seat:

Recorded seat positions can be recalled up to 180 seconds after the front passenger's door is opened.

■ **In order to correctly use the driving position memory function**

If a seat position is already in the furthest possible position and the seat is operated in the same direction, the recorded position may be slightly different when it is recalled.

Memory recall function (driver's side only)

Each electronic key (including a card key) can be registered to recall your preferred driving position.

■ Registering procedure

Record your driving position to switch "1", "2" or "3" before performing the following:

▶ Using the wireless remote control

- 1 Turn the engine switch off and close the driver's door.
- 2 While pressing the desired switch ("1", "2" or "3"), press  on the wireless remote control until the buzzer sounds.



To prevent unintended triggering of the alarm, open and close a door once after a driving position has been recorded. (If a door is not opened within 30 seconds after  is pressed, the doors will be locked again and the alarm will automatically be set.)

In case that the alarm is triggered, immediately stop the alarm.

(→P. 80)

3

Operation of each component

▶ Using the door lock switch

Carry only one of the keys (including the card key) to which you want to link the driving position. If 2 or more keys are in the vehicle, the driving position cannot be linked properly.

1 Turn the engine switch off and close the driver's door.

2 While pressing the recalled switch, press and hold the door lock switch (either lock or unlock) until the buzzer sounds.

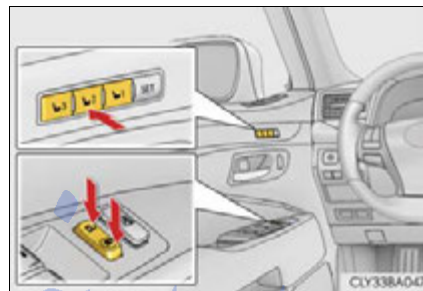

■ Recall procedure

1 Carry the electronic key that has been registered to the driving position, and then unlock and open the driver's door using the smart access system with push-button start or wireless remote control.

The driving position will move to the recorded position (not including the steering wheel). However, the seat will move to a position slightly behind the recorded position in order to make entering the vehicle easier.

If the driving position is in a position that has already been recorded, the seat and outside rear view mirrors will not move.

2 Turn the engine switch to ACCESSORY mode or fasten your seat-belt.

The seat and steering wheel will move to the recorded position.

■ Cancellation procedure

- ▶ Using the wireless remote control

- 1 Turn the engine switch off and close the driver's door.
- 2 While pressing the "SET" switch, press  on the wireless remote control until the buzzer sounds.

- ▶ Using the door lock switch

Carry only the key you want to cancel and then close the driver's door. If 2 or more keys are in the vehicle, the driving position cannot be canceled properly.

- 1 Turn the engine switch off and close the driver's door.
- 2 While pressing the "SET" switch, press the lock or unlock side on the door lock switch until the buzzer sounds.

■ Recalling the driving position using the memory recall function

- Different driving positions can be registered for each electronic key. Therefore, the driving position that is recalled may be different depending on the key being carried.
- If a door other than the driver's door is unlocked with the smart access system with push-button start, the driving position cannot be recalled. In this case, press the driving position switch which has been set.

■ Seat operation automatic stop function (vehicles with relaxation seat)

If a front seat is likely to come into contact with the retractable table (4-seat models) or the ottoman during seat operation or activation of the power easy access system, a buzzer will sound and seat slide operation will be stopped partway. (A warning message will be shown on the multi-information display.)

CAUTION

■ Seat adjustment caution

Take care during seat adjustment so that the seat does not strike the rear passenger or squeeze your body against the steering wheel.

Rear seat position memory*

The rear seat position can be memorized and recalled with the touch of a button.

Entering a position to memory

- 1 Turn the engine switch to IGNITION ON mode.
- 2 Adjust the rear seat to the desired position.
- 3 Press the "SET" button until the signal beeps.

If the preset is being used, the previously recorded seat position will be overwritten.

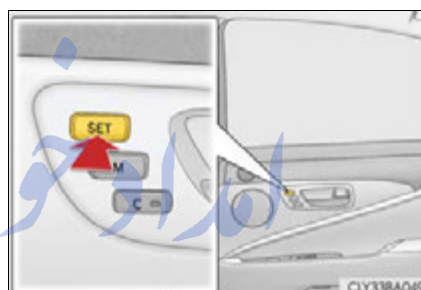

Recalling the memorized position

Press the "M" button until the signal beeps.

Relaxation seat:

The memorized position will only be recalled if the ottoman is in a position higher than the memorized position. It will not move in an upward direction.



*: If equipped

Disabling the seat return function

Pressing the “C” button will disable the seat position recall or seat return function.

The indicator light comes on when the function is disabled.

Pressing the button again will enable the seat position recall or seat return function.

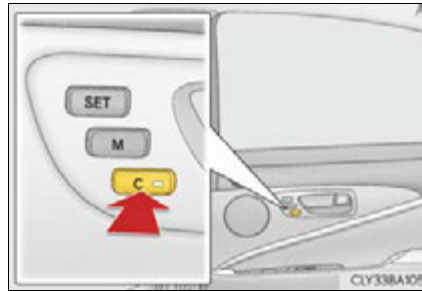

■ Seat return function linked to the door opening operation

- Operating conditions
 - The engine switch is in IGNITION ON mode.
- Canceling operation partway through
 - During the seat return operation, performing either of the following actions cancels the operation:
 - Pressing the “SET”, “M” or “C” button
 - Pressing any of the seat adjustment switches
- Seat return operation after turning the engine switch off
 - The seat will automatically return to the neutral position if the door is opened within approximately 45 seconds of the engine switch being turned off.

⚠ CAUTION

■ Seat adjustment caution

Take care during seat adjustment so that the rear passengers do not strike the front seats.

3

Operation of each component

Head restraints

Head restraints are provided for all seats.

Front seats

- ① Vertical adjustment
- ② Horizontal adjustment

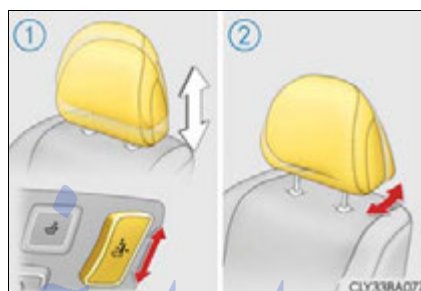

Outer rear seats

► Manual type

- ① Vertical adjustment
Pull the head restraints up when raising.
Push and hold the lock release button when lowering.

► Power type

- ① Vertical adjustment
- ② Side support adjustment

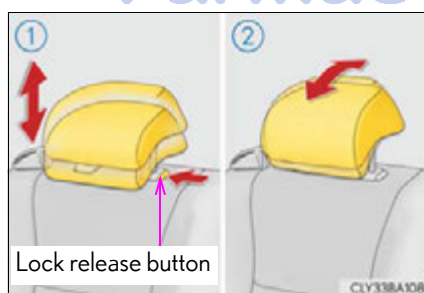

Rear center seat (5-seat models)

- ① To use
- ② To fold

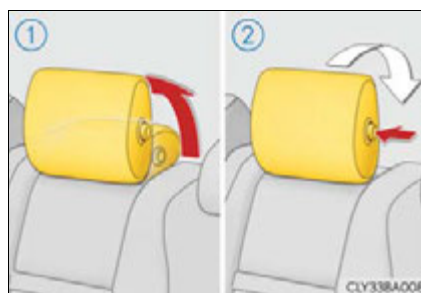

Active head restraints (front seats)

If the vehicle detects an impact during a rear-end collision, the front part of the head restraint moves forward and upward to help reduce the risk of whiplash to the seat occupant.

When reversing, even a small amount of force applied from the rear, such as a minor rear impact, may cause the head restraints to move.

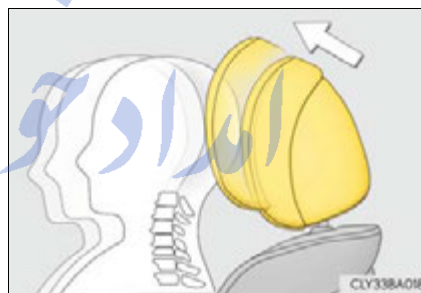

3

Operation of each component

FarmaSOS.com

■ **Removing the head restraints**

For removal and installation of the head restraint, contact your Lexus dealer.

■ **Adjusting the height of the head restraints (except rear center seat)**

Make sure that the head restraints are adjusted so that the center of the head restraint is closest to the top of your ears.

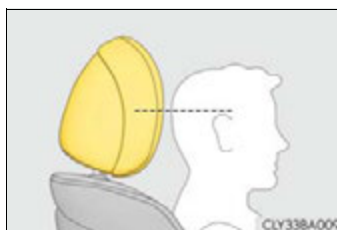

■ **When using the rear seat head restraints**

Manual type:

Always raise the head restraint one level from the stowed position when using.

Rear center seat:

Make sure to pull the head restraint forward when using the rear center seat.

■ **Active head restraints (if equipped)**

- The active head restraint on the front passenger seat will not activate if the seat is unoccupied. However, it may activate during a rear-end collision if luggage is in the seat or the seat belt is fastened.
- Once the active head restraint has activated, the head restraint remains protruded forward and upward. After it has operated, have it repaired at your Lexus dealer.

FarmaSOS.com

⚠ CAUTION**■ Head restraint precautions**

Observe the following precautions regarding the head restraints. Failure to do so may result in death or serious injury.

- Use the head restraints designed for each respective seat.
- Adjust the head restraints to the correct position at all times.
- Manual type: After adjusting the head restraints, push down on them and make sure they are locked in position.
- Do not drive with the head restraints removed.

■ The active head restraint on the front passenger seat (if equipped)

Do not place anything, such as a cushion, on the front passenger's seat. Doing so will disperse the passenger's weight, which may prevent the sensor from detecting the passenger's weight properly. As a result, the active head restraint may not activate in the event of an accident.

■ Active head restraint precautions (if equipped)

- Do not put head restraint covers.
 - For removal, installation, modification, disassembly or disposal of the active head restraints, contact your Lexus dealer.
- Inappropriate handling of the active head restraints may prevent them from operating properly during an accident.

3

Operation of each component

FarmaSOS.com

Steering wheel

Adjustment procedure

Operating the switch moves the steering wheel in the following directions:

- ① Up
- ② Down
- ③ Toward the driver
- ④ Away from the driver

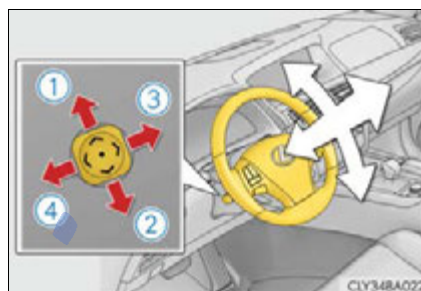

■ The steering wheel can be adjusted when

The engine switch is in ACCESSORY or IGNITION ON mode*.

*: If the driver's seat belt is fastened, the steering wheel can be adjusted regardless of engine switch mode.

■ Automatic adjustment of the steering position

A desired steering position can be entered to memory and recalled automatically by the driving position memory system. (→P. 163)

■ Power easy access system

The steering wheel and driver's seat move in accordance with engine switch mode and the driver's seat belt condition. (→P. 147)

⚠ CAUTION

Do not adjust the steering wheel while driving.
Doing so may cause the driver to mishandle the vehicle and cause an accident, resulting in death or serious injury.

Inside rear view mirror

The rear view mirror's position can be adjusted to enable sufficient confirmation of the rear view.

Adjusting the height of rear view mirror

The height of the rear view mirror can be adjusted to suit your driving posture.

Adjust the height of the rear view mirror by moving it up and down.

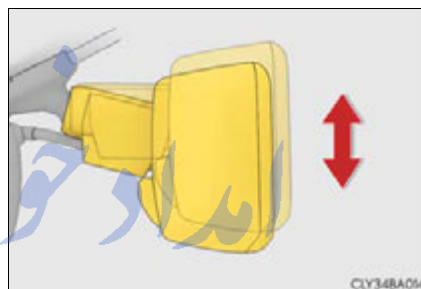

3

Operation of each component

Anti-glare function

Responding to the level of brightness of the headlights of vehicles behind, the reflected light is automatically reduced.

Changing automatic anti-glare function mode

- ① ON
- ② OFF

When the automatic anti-glare function is in ON mode, the indicator illuminates.

The function will set to ON mode each time the engine switch is turned to IGNITION ON mode.

Pressing the button turns the function to OFF mode. (The indicator also turns off.)

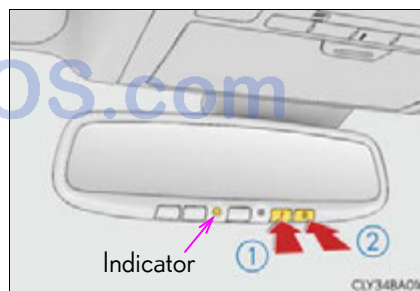

■ To prevent sensor error

To ensure that the sensors operate properly, do not touch or cover them.

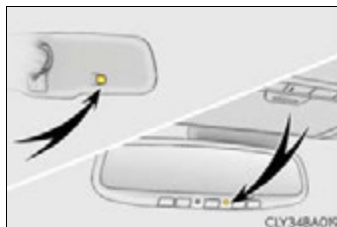
**⚠ CAUTION**

Do not adjust the position of the mirror while driving. Doing so may lead to mishandling of the vehicle and cause an accident, resulting in death or serious injury.

امداد خودرو فارما

تلفن شبانه روزی: ۰۲۱-۸۸۸۶۲۰۸۵

FarmaSOS.com

Outside rear view mirrors

Adjustment procedure

1 Select the mirror to be adjusted.

- ① Left
- ② Neutral position
- ③ Right



2 To adjust the mirror, press the switch.

- ① Up
- ② Right
- ③ Down
- ④ Left

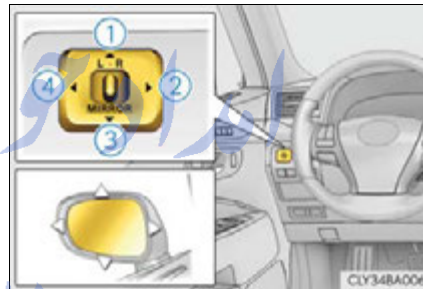

3

Operation of each component

FarmaSOS.com

Folding and extending the mirrors

■ Using the switch

- ① Folds the mirrors
- ② Extends the mirrors



■ Setting automatic mode

Automatic mode allows the folding or extending of the mirrors to be linked to locking/unlocking of the doors.

To set to automatic mode, put the switch in the neutral position.

The indicator will come on.

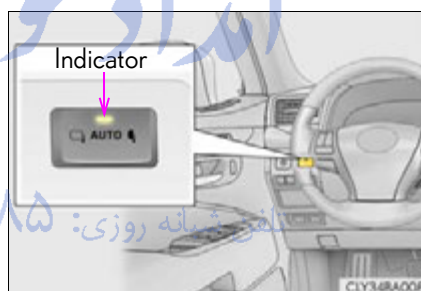

FarmaSOS.com

Linked mirror function when reversing

When the mirror select switch is in the “L” or “R” position, the outside rear view mirrors will automatically angle downwards when the vehicle is reversing in order to give a better view of the ground.

To disable this function, move the mirror select switch to the neutral position (between “L” and “R”).

■ Adjusting the mirror angle when the vehicle is reversing

With the shift lever in R, adjust the mirror angle at a desired position.

The adjusted angle will be memorized and the mirror will automatically tilt to the memorized angle whenever the shift lever is shifted to R from next time.

The memorized downward tilt position of the mirror is linked to the normal position (angle adjusted with the shift lever in other than R). Therefore, if the normal position is changed after adjustment, the tilt position will also change.

When the normal position is changed, readjust the angle in reversing.

3

Operation of each component

■ Mirror angle can be adjusted when

The engine switch is in ACCESSORY or IGNITION ON mode.

■ When the mirrors are fogged up

The outside rear view mirrors can be cleared using the mirror defoggers. Turn on the rear window defogger to turn on the outside rear view mirror defoggers. (→P. 359)

■ Automatic adjustment of the mirror angle

A desired mirror face angle can be entered to memory and recalled automatically by the driving position memory. (→P. 163)

■ Auto anti-glare function

When the anti-glare inside rear view mirror is set to automatic mode, the outside rear view mirrors will activate in conjunction with the anti-glare inside rear view mirror to reduce reflected light. (→P. 175)

■ Using automatic mode in cold weather

When automatic mode is used in cold weather, the door mirror could freeze up and automatic stowing and return may not be possible. In this event, remove any ice and snow from the door mirror, then either operate the mirror using manual mode or move the mirror by hand.

⚠ CAUTION**■ Important points while driving**

Observe the following precautions while driving.
Failure to do so may result in loss of control of the vehicle and cause an accident, resulting in death or serious injury.

- Do not adjust the mirrors while driving.
- Do not drive with the mirrors folded.
- Both the driver and passenger side mirrors must be extended and properly adjusted before driving.

■ When a mirror is moving

To avoid personal injury and mirror malfunction, be careful not to get your hand caught by the moving mirror.

■ When the mirror defoggers are operating

Do not touch the rear view mirror surfaces, as they can become very hot and burn you.

تلفن شبانه روزی: ۰۲۱-۸۸۸۶۲۰۸۵

FarmaSOS.com

Power windows

Opening and closing procedures

The power windows can be opened and closed using the switches.

Operating the switch moves the windows as follows:

- ① Closing
- ② One-touch closing*
- ③ Opening
- ④ One-touch opening*

*: To stop the window partway, operate the switch in the opposite direction.

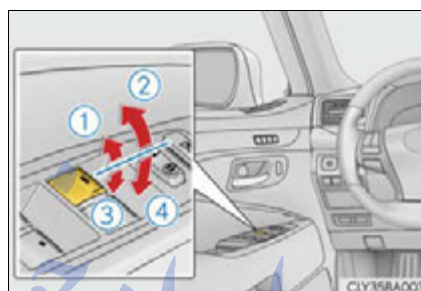

Window lock switch

Press the switch down to lock the passenger window switches.

Use this switch to prevent children from accidentally opening or closing a passenger window.

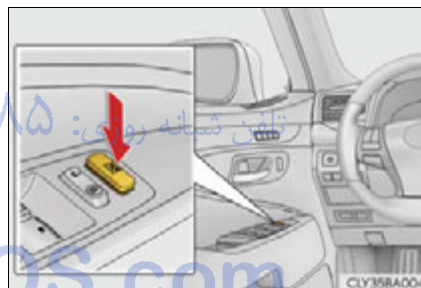

3

Operation of each component

■ The power windows can be operated when

The engine switch is in IGNITION ON mode.

■ Operating the power windows after turning the engine off

The power windows can be operated for approximately 45 seconds even after the engine switch is turned to ACCESSORY mode or turned off. They cannot, however, be operated once either front door is opened.

■ Jam protection function

If an object becomes caught between the window and the window frame, window travel is stopped and the window is opened slightly.

■ Pinch protection function

While the window is opening, if an object is caught between the door and window, window travel is stopped.

■ If the power window does not close or open normally

If the jam protection function or pinch protection function is malfunctioning and a window cannot be closed or opened completely, perform the following operations using the power window switch of the relevant door:

● When not closing normally

With the vehicle stopped and the engine switch in IGNITION ON mode, within 4 seconds of the jam protection function operating, pull and hold the power window switch in the one-touch closing position. When the window is closed completely, release the switch.

● When not opening normally

With the vehicle stopped and the engine switch in IGNITION ON mode, within 4 seconds of the pinch protection function operating, press and hold the power window switch in the one-touch opening position. When the window is opened completely, release the switch.

If the window still cannot be closed or opened completely even though the above operations have been carried out, perform the following initialization procedure.

- 1 Turn the engine switch to IGNITION ON mode.
- 2 Pull and hold the power window switch in the one-touch closing position.
- 3 When the window is closed completely, release the power window switch. Pull and hold the switch in the one-touch closing position again for approximately 4 seconds.
- 4 Press and hold the power window switch in the one-touch opening position. Continue pressing the switch for 1 second after the window has opened completely.
- 5 Pull and hold the power window switch in the one-touch closing position. Continue pulling the switch for 1 second after the window has closed.

If you release the switch while the window is moving, perform the procedure again from the beginning.

If, after performing the above procedure correctly, the window continues to close but then re-open slightly or open but then close again slightly, have the vehicle inspected by your Lexus dealer.

■ Door lock linked window operation

- The power windows can be closed using the entry function. (→P. 115)
- The power windows can be opened and closed using the mechanical key. (→P. 536)

■ Customization

Settings (e.g. linked door lock operation) can be changed.
(Customizable features →P. 577)

⚠ CAUTION

Observe the following precautions.
Failure to do so may result in death or serious injury.

■ Closing the windows

- The driver is responsible for all the power window operations, including the operation for the passengers. In order to prevent accidental operation, especially by a child, do not let a child operate the power windows. It is possible for children and other passengers to have body parts caught in the power window. Also, when riding with a child, it is recommended to use the window lock switch. (→P. 181)
- Check to make sure that all passengers do not have any part of their body in a position where it could be caught when a window is being operated.
- When using the smart access system with push-button start, wireless remote control or mechanical key and operating the power windows, operate the power window after checking to make sure that there is no possibility of any passenger having any of their body parts caught in the window. Also do not let a child operate window by the smart access system with push-button start, wireless remote control or mechanical key. It is possible for children and other passengers to get caught in the power window.
- When exiting the vehicle, turn the engine switch off, carry the key and exit the vehicle along with the child. There may be accidental operation, due to mischief, etc., that may possibly lead to an accident.

⚠ CAUTION**■ Jam protection function**

- Never use any part of your body to intentionally activate the jam protection function.
- The jam protection function may not work if something gets caught just before the window fully closes.

■ Pinch protection function

- Do not use a hand, arm, or clothing to intentionally activate the pinch protection function.
- The pinch protection function may not operate if something gets caught just before the window is fully opened. Take care so that your hands, arms, or clothing do not get caught.

امداد خودرو فارما

تلفن شبانه روزی: ۰۲۱-۸۸۸۶۲۰۸۵

FarmaSOS.com

Moon roof

Use the overhead switches to open and close the moon roof and tilt it up and down.

Opening and closing

- ① Opens the moon roof*

The moon roof stops slightly before the fully open position to reduce wind noise.

Press the switch again to fully open the moon roof.

- ② Closes the moon roof*

*: Lightly press either way of the moon roof switch to stop the moon roof partway.

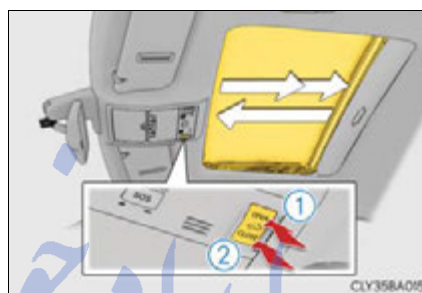

Tilting up and down

- ① Tilts the moon roof up*

- ② Tilts the moon roof down*

*: Lightly press either way of the moon roof switch to stop the moon roof partway.



3

Operation of each component

■ The moon roof can be operated when

The engine switch is in IGNITION ON mode.

■ Operating the moon roof after turning the engine off

The moon roof can be operated for approximately 45 seconds after the engine switch is turned to ACCESSORY mode or turned off. It cannot, however, be operated once either front door is opened.

■ Jam protection function

If an object is detected between the moon roof and the frame while the moon roof is closing or tilting down, travel is stopped and the moon roof opens slightly.

■ Sunshade

The sunshade can be opened and closed manually. However, the sunshade will open automatically when the moon roof is opened.

■ Door lock linked moon roof operation

- The moon roof can be closed using the entry function. (→P. 115)
- The moon roof can be opened and closed using the mechanical key. (→P. 536)

تلفن شبانه روزی: ۰۲۱-۸۸۸۶۲۰۸۵

FarmaSOS.com

■ When the moon roof does not close normally

Perform the following procedure:

- If the moon roof closes but then re-opens slightly

- 1 Stop the vehicle.
- 2 Press and hold the "CLOSE" switch.*1
The moon roof will close, reopen and pause for approximately 10 seconds.*2
Then it will close again, tilt up and pause for approximately 1 second. Finally, it will tilt down, open and close.
- 3 Check to make sure that the moon roof is completely closed and then release the switch.

- If the moon roof tilts down but then tilts back up

- 1 Stop the vehicle.
- 2 Press and hold the "UP" switch*1 until the moon roof moves into the tilt up position and stops.
- 3 Release the "UP" switch once and then press and hold the "UP" switch again.*1
The moon roof will pause for approximately 10 seconds in the tilt up position.*2
Then it will adjust slightly and pause for approximately 1 second. Finally, it will tilt down, open and close.
- 4 Check to make sure that the moon roof is completely closed and then release the switch.

*1: If the switch is released at the incorrect time, the procedure will have to be performed again from the beginning.

*2: If the switch is released after the above mentioned 10 second pause, automatic operation will be disabled. In that case, press and hold the "CLOSE" or "UP" switch, and the moon roof will tilt up and pause for approximately 1 second. Then it will tilt down, open and close. Check to make sure that the moon roof is completely closed and then release the switch.

If the moon roof does not fully close even after performing the above procedure correctly, have the vehicle inspected by your Lexus dealer.

■ Moon roof open warning buzzer

The buzzer sounds and a message is shown on the multi-information display in the instrument cluster when the engine switch is turned off and the driver's door is opened with the moon roof open.

■ Customization

Settings (e.g. linked door lock operation) can be changed.
(Customizable features →P. 577)

⚠ CAUTION

Observe the following precautions.
Failure to do so may cause death or serious injury.

■ Opening the moon roof

- Do not allow any passengers to put their hands or heads outside the vehicle while it is moving.
- Do not sit on top of the moon roof.

■ Closing the moon roof

- The driver is responsible for moon roof opening and closing operations.
In order to prevent accidental operation, especially by a child, do not let a child operate the moon roof. It is possible for children and other passengers to have body parts caught in the moon roof.
- Check to make sure that all passengers do not have any part of their body in a position where it could be caught when the moon roof is being operated.
- When using the smart access system with push-button start, wireless remote control or mechanical key and operating the moon roof, operate the moon roof after checking to make sure that there is no possibility of any passenger having any of their body parts caught in the moon roof. Also, do not let a child operate moon roof by the smart access system with push-button start, wireless remote control or mechanical key. It is possible for children and other passengers to get caught in the moon roof.
- When exiting the vehicle, turn the engine switch off, carry the key and exit the vehicle along with the child. There may be accidental operation, due to mischief, etc., that may possibly lead to an accident.

■ Jam protection function

- Never use any part of your body to intentionally activate the jam protection function.
- The jam protection function may not work if something gets caught just before the moon roof fully closes.

4-1. Before driving	
Driving the vehicle.....	190
Cargo and luggage.....	201
Vehicle load limits	205
Trailer towing.....	206
Dinghy towing.....	207
4-2. Driving procedures	
Engine (ignition) switch	208
Automatic transmission (except 2WD models with paddle shift switches)	213
Automatic transmission (2WD models with paddle shift switches).....	218
Turn signal lever	224
Parking brake.....	225
Brake Hold.....	228
Horn.....	230
4-3. Operating the lights and wipers	
Headlight switch.....	231
Automatic High Beam	235
Fog light switch.....	240
Windshield wipers and washer.....	241
Headlight cleaner switch	245
4-4. Refueling	
Opening the fuel tank cap.....	246
4-5. Using the driving support systems	
Cruise control	250
Dynamic radar cruise control with full-speed range.....	254
LKA (Lane-Keeping Assist).....	271
Driving mode select switch	281
Electronically modulated air suspension.....	284
Driving assist systems.....	286
PCS (Pre-Collision System).....	293
BSM (Blind Spot Monitor).....	306
• The Blind Spot Monitor function	310
• The Rear Cross Traffic Alert function.....	313
Lexus night view	316
4-6. Driving tips	
Winter driving tips	321

Driving the vehicle

The following procedures should be observed to ensure safe driving:

Starting the engine

→P. 208

Driving

- 1 With the brake pedal depressed, shift the shift lever to D.
(→P. 213, 218)
- 2 If the parking brake is in manual mode, release the parking brake.
(→P. 225)
- 3 Gradually release the brake pedal and gently depress the accelerator pedal to accelerate the vehicle.

Stopping

- 1 With the shift lever in D, depress the brake pedal.
- 2 If necessary, set the parking brake.
If the vehicle is to be stopped for an extended period of time, shift the shift lever to P or N. (→P. 213, 218)

Parking the vehicle

- 1 With the shift lever in D, depress the brake pedal.
- 2 If the parking brake is in manual mode, set the parking brake.
(→P. 225)
- 3 Shift the shift lever to P. (→P. 213, 218)
If parking on a hill, block the wheels as needed.
- 4 Press the engine switch to stop the engine.
- 5 Lock the door, making sure that you have the electronic key on your person.

Starting off on a steep uphill

- 1 Make sure that the parking brake is set and shift the shift lever to D.
- 2 Gently depress the accelerator pedal.
- 3 Release the parking brake.

■ When starting off on a uphill

Hill-start assist control will operate. (→P. 286)

■ Driving in the rain

- Drive carefully when it is raining, because visibility will be reduced, the windows may become fogged-up, and the road will be slippery.
- Drive carefully when it starts to rain, because the road surface will be especially slippery.
- Refrain from high speeds when driving on an expressway in the rain, because there may be a layer of water between the tires and the road surface, preventing the steering and brakes from operating properly.

■ Engine speed while driving

In the following conditions, the engine speed may become high while driving. This is due to automatic up-shifting control or down-shifting implementation to meet driving conditions. It does not indicate sudden acceleration.

- The vehicle is judged to be driving uphill or downhill
- When the accelerator pedal is released
- When the brake pedal is depressed while sport mode is selected

■ **Breaking in your new Lexus**

To extend the life of the vehicle, observing the following precautions is recommended:

- For the first 186 miles (300 km):
Avoid sudden stops.
- For the first 621 miles (1000 km):
 - Do not drive at extremely high speeds.
 - Avoid sudden acceleration.
 - Do not drive continuously in low gears.
 - Do not drive at a constant speed for extended periods.

■ **Drum-in-disc type parking brake system**

Your vehicle has a drum-in-disc type parking brake system. This type of brake system needs bedding-down of the brake shoes periodically or whenever the parking brake shoes and/or drum are replaced. Have your Lexus dealer perform the bedding down operation.

■ **Operating your vehicle in a foreign country**

Comply with the relevant vehicle registration laws and confirm the availability of the correct fuel. (→P. 563)

■ **Regarding engine speed when idling**

When idling with the shift lever in P or N for an extensive period of time, the engine speed may rise to approximately 1000 rpm (r/min). This is not a malfunction. After a set period of time, the engine will return to its previous engine speed.

FarmaSOS.com

⚠ CAUTION

Observe the following precautions.
Failure to do so may result in death or serious injury.

■ When starting the vehicle

Always keep your foot on the brake pedal while stopped with the engine running.
This prevents the vehicle from creeping.

■ When driving the vehicle

- Do not drive if you are unfamiliar with the location of the brake and accelerator pedals to avoid depressing the wrong pedal.
 - Accidentally depressing the accelerator pedal instead of the brake pedal will result in sudden acceleration that may lead to an accident.
 - When backing up, you may twist your body around, leading to a difficulty in operating the pedals. Make sure to operate the pedals properly.
 - Make sure to keep a correct driving posture even when moving the vehicle only slightly. This allows you to depress the brake and accelerator pedals properly.
 - Depress the brake pedal using your right foot. Depressing the brake pedal using your left foot may delay response in an emergency, resulting in an accident.
- Do not drive the vehicle over or stop the vehicle near flammable materials.
The exhaust system and exhaust gases can be extremely hot. These hot parts may cause a fire if there is any flammable material nearby.

⚠ CAUTION

Observe the following precautions.
Failure to do so may result in death or serious injury.

■ When driving the vehicle

- During normal driving, do not turn off the engine. Turning the engine off while driving will not cause loss of steering or braking control, however, power assist to the steering will be lost. This will make it more difficult to steer smoothly, so you should pull over and stop the vehicle as soon as it is safe to do so.
In the event of an emergency, such as if it becomes impossible to stop the vehicle in the normal way: →P. 495
- Use engine braking (downshift) to maintain a safe speed when driving down a steep hill.
Using the brakes continuously may cause the brakes to overheat and lose effectiveness. (→P. 213, 218)
- Do not adjust the positions of the steering wheel, the seat, or the inside or outside rear view mirrors while driving.
Doing so may result in a loss of vehicle control.
- Always check that all passengers' arms, heads or other parts of their body are not outside the vehicle.
- Do not drive in excess of the speed limit. Even if the legal speed limit permits it, do not drive over 85 mph (140 km/h) unless your vehicle has high-speed capability tires. Driving over 85 mph (140 km/h) may result in tire failure, loss of control and possible injury. Be sure to consult a tire dealer to determine whether the tires on your vehicle are high-speed capability tires or not before driving at such speeds.

FarmaSOS.com

⚠ CAUTION

Observe the following precautions.
Failure to do so may result in death or serious injury.

■ When driving on slippery road surfaces

- Sudden braking, acceleration and steering may cause tire slippage and reduce your ability to control the vehicle.
- Sudden acceleration, engine braking due to shifting, or changes in engine speed could cause the vehicle to skid.
- After driving through a puddle, lightly depress the brake pedal to make sure that the brakes are functioning properly. Wet brake pads may prevent the brakes from functioning properly. If the brakes on only one side are wet and not functioning properly, steering control may be affected.

■ When shifting the shift lever

- Do not let the vehicle roll backward while the shift lever is in a driving position, or roll forward while the shift lever is in R.
Doing so may cause the engine to stall or lead to poor brake and steering performance, resulting in an accident or damage to the vehicle.
- Do not shift the shift lever to P while the vehicle is moving.
Doing so can damage the transmission and may result in a loss of vehicle control.
- Do not shift the shift lever to R while the vehicle is moving forward.
Doing so can damage the transmission and may result in a loss of vehicle control.
- Do not shift the shift lever to a driving position while the vehicle is moving backward.
Doing so can damage the transmission and may result in a loss of vehicle control.
- Do not shift the shift lever to N while the vehicle is moving. Doing so will disengage the engine from the transmission. Engine braking is not available when N is selected.
- Be careful not to shift the shift lever with the accelerator pedal depressed. Shifting the shift lever to a gear other than P or N may lead to unexpected rapid acceleration of the vehicle that may cause an accident and result in death or serious injury.

⚠ CAUTION

Observe the following precautions.
Failure to do so may result in death or serious injury.

■ If a brake pad wear warning message is displayed

Have your Lexus dealer check and replace the brake pads as soon as possible.
The rotor damage can result if the pads are not replaced when needed.

Moderate levels of the brake pad and disc wear allow enhanced braking power. As a result, the discs may wear more quickly than conventional brake discs. Therefore, when replacing the brake pads, Lexus recommends that you also have the thickness of the discs measured.

It is dangerous to drive the vehicle when the wear limits of the brake pads and/or those of the brake discs are exceeded.

■ When the vehicle is stopped

- Do not race the engine.
If the vehicle is in any gear other than P or N, the vehicle may accelerate suddenly and unexpectedly, causing an accident.
- In order to prevent accidents due to the vehicle rolling away, always keep depressing the brake pedal while the engine is running, and apply the parking brake as necessary.
- If the vehicle is stopped on an incline, in order to prevent accidents caused by the vehicle rolling forward or backward, always depress the brake pedal and securely apply the parking brake as needed.
- Avoid revving or racing the engine.
Running the engine at high speed while the vehicle is stopped may cause the exhaust system to overheat, which could result in a fire if combustible material is nearby.

 **CAUTION**

Observe the following precautions.
Failure to do so may result in death or serious injury.

■ **When the vehicle is parked**

- Do not leave glasses, cigarette lighters, spray cans, or soft drink cans in the vehicle when it is in the sun.
Doing so may result in the following:
 - Gas may leak from a cigarette lighter or spray can, and may lead to a fire.
 - The temperature inside the vehicle may cause the plastic lenses and plastic material of glasses to deform or crack.
 - Soft drink cans may fracture, causing the contents to spray over the interior of the vehicle, and may also cause a short circuit in the vehicle's electrical components.
- Do not leave cigarette lighters in the vehicle. If a cigarette lighter is in a place such as the glove box or on the floor, it may be lit accidentally when luggage is loaded or the seat is adjusted, causing a fire.
- Do not attach adhesive discs to the windshield or windows. Do not place containers such as air fresheners on the instrument panel or dashboard. Adhesive discs or containers may act as lenses, causing a fire in the vehicle.
- Do not leave a door or window open if the curved glass is coated with a metalized film such as a silver-colored one. Reflected sunlight may cause the glass to act as a lens, causing a fire.
- Always apply the parking brake, shift the shift lever to P, stop the engine and lock the vehicle.
Do not leave the vehicle unattended while the engine is running.
- Do not touch the exhaust pipes while the engine is running or immediately after turning the engine off.
Doing so may cause burns.

⚠ CAUTION

Observe the following precautions.
Failure to do so may result in death or serious injury.

■ When taking a nap in the vehicle

Always turn the engine off. Otherwise, if you accidentally move the shift lever or depress the accelerator pedal, this could cause an accident or fire due to engine overheating. Additionally, if the vehicle is parked in a poorly ventilated area, exhaust gases may collect and enter the vehicle, leading to death or a serious health hazard.

■ When braking

- When the brakes are wet, drive more cautiously.
Braking distance increases when the brakes are wet, and this may cause one side of the vehicle to brake differently than the other side. Also, the parking brake may not securely hold the vehicle.
- If the electronically controlled brake system does not operate, do not follow other vehicles closely and avoid hills or sharp turns that require braking.
In this case, braking is still possible, but the brake pedal should be depressed more firmly than usual. Also, the braking distance will increase. Have your brakes fixed immediately.
- The brake system consists of 2 or more individual hydraulic systems; if one of the systems fails, the other(s) will still operate. In this case, the brake pedal should be depressed more firmly than usual and the braking distance will increase. Have your brakes fixed immediately.

■ If the vehicle becomes stuck (AWD models)

Do not spin the wheels excessively when any of the tires is up in the air, or the vehicle is stuck in sand, mud, etc. This may damage the driveline components or propel the vehicle forward or backward, causing an accident.

 NOTICE

■ When driving the vehicle

- Do not depress the accelerator and brake pedals at the same time during driving, as this may restrain driving torque.
- Do not use the accelerator pedal or depress the accelerator and brake pedals at the same time to hold the vehicle on a hill.

■ When parking the vehicle

Always shift the shift lever to P. Failure to do so may cause the vehicle to move or the vehicle may accelerate suddenly if the accelerator pedal is accidentally depressed.

■ Avoiding damage to vehicle parts

- Do not turn the steering wheel fully in either direction and hold it there for an extended period of time.
Doing so may damage the power steering motor.
- When driving over bumps in the road, drive as slowly as possible to avoid damaging the wheels, underside of the vehicle, etc.

■ If you get a flat tire while driving

A flat or damaged tire may cause the following situations. Hold the steering wheel firmly and gradually depress the brake pedal to slow down the vehicle.

- It may be difficult to control your vehicle.
- The vehicle will make abnormal sounds or vibrations.
- The vehicle will lean abnormally.

Information on what to do in case of a flat tire (→P. 518, 527)

 NOTICE**■ When encountering flooded roads**

Do not drive on a road that has flooded after heavy rain etc. Doing so may cause the following serious damage to the vehicle:

- Engine stalling
- Short in electrical components
- Engine damage caused by water immersion

In the event that you drive on a flooded road and the vehicle is flooded, be sure to have your Lexus dealer check the following:

- Brake function
- Changes in quantity and quality of oil and fluid used for the engine, transmission, transfer (AWD models), differential, etc.
- Lubricant condition for the propeller shaft, bearings and suspension joints (where possible), and the function of all joints, bearings, etc.

تلفن شبانه روزی: ۰۲۱-۸۸۸۶۲۰۸۵

FarmaSOS.com

Cargo and luggage

Take notice of the following information about storage precautions, cargo capacity and load:

Capacity and distribution

Cargo capacity depends on the total weight of the occupants.

(Cargo capacity) = (Total load capacity) – (Total weight of occupants)

Steps for Determining Correct Load Limit –

- (1) Locate the statement “The combined weight of occupants and cargo should never exceed XXX kg or XXX lbs.” on your vehicle’s placard.
- (2) Determine the combined weight of the driver and passengers that will be riding in your vehicle.
- (3) Subtract the combined weight of the driver and passengers from XXX kg or XXX lbs.
- (4) The resulting figure equals the available amount of cargo and luggage load capacity.

For example, if the “XXX” amount equals 1400 lbs. and there will be five 150 lb passengers in your vehicle, the amount of available cargo and luggage load capacity is 650 lbs. (1400 – 750 (5 × 150) = 650 lbs.)
- (5) Determine the combined weight of luggage and cargo being loaded on the vehicle. That weight may not safely exceed the available cargo and luggage load capacity calculated in Step 4.
- (6) If your vehicle will be towing a trailer, load from your trailer will be transferred to your vehicle. Consult this manual to determine how this reduces the available cargo and luggage load capacity of your vehicle.

(→P. 205)

Lexus does not recommend towing a trailer with your vehicle. Your vehicle is not designed for trailer towing.

Calculation formula for your vehicle

- ① Cargo capacity
- ② Total load capacity (vehicle capacity weight) (→P. 550)

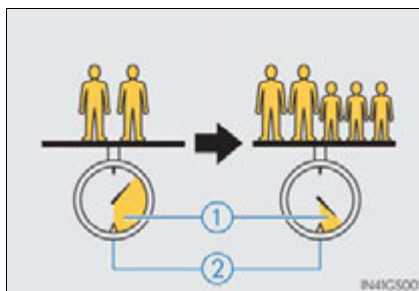

► 5-seat models

When 2 people with the combined weight of A lb. (kg) are riding in your vehicle, which has a total load capacity (vehicle capacity weight) of B lb. (kg), the available amount of cargo and luggage load capacity will be C lb. (kg) as follows:

$$B^{*2} \text{ lb. (kg)} - A^{*1} \text{ lb. (kg)} = C^{*3} \text{ lb. (kg)}$$

*1: A = Weight of people

*2: B = Total load capacity

*3: C = Available cargo and luggage load

In this condition, if 3 more passengers with the combined weight of D lb. (kg) get on, the available cargo and luggage load will be reduced E lb. (kg) as follows:

$$C \text{ lb. (kg)} - D^{*4} \text{ lb. (kg)} = E^{*5} \text{ lb. (kg)}$$

*4: D = Additional weight of people

*5: E = Available cargo and luggage load

► 4-seat models

When 2 people with the combined weight of A lb. (kg) are riding in your vehicle, which has a total load capacity (vehicle capacity weight) of B lb. (kg), the available amount of cargo and luggage load capacity will be C lb. (kg) as follows:

$$B^{*2} \text{ lb. (kg)} - A^{*1} \text{ lb. (kg)} = C^{*3} \text{ lb. (kg)}$$

*1: A =Weight of people

*2: B =Total load capacity

*3: C =Available cargo and luggage load

In this condition, if 2 more passengers with the combined weight of D lb. (kg) get on, the available cargo and luggage load will be reduced E lb. (kg) as follows:

$$C \text{ lb. (kg)} - D^{*4} \text{ lb. (kg)} = E^{*5} \text{ lb. (kg)}$$

*4: D =Additional weight of people

*5: E =Available cargo and luggage load

As shown in the example above, if the number of occupants increases, the cargo and luggage load will be reduced by an amount that equals the increased weight due to the additional occupants. In other words, if an increase in the number of occupants causes an excess of the total load capacity (combined weight of occupants plus cargo and luggage load), you must reduce the cargo and luggage on your vehicle.

⚠ CAUTION**■ Things that must not be carried in the trunk**

The following things may cause a fire if loaded in the trunk:

- Receptacles containing gasoline
- Aerosol cans

■ Storage precautions

Observe the following precautions.

Failure to do so may prevent the pedals from being depressed properly, may block the driver's vision, or may result in items hitting the driver or passengers, possibly causing an accident.

- Stow cargo and luggage in the trunk whenever possible.
- Do not place cargo or luggage in or on the following locations.
 - At the feet of the driver
 - On the front passenger or rear seats (when stacking items)
 - On the package tray
 - On the instrument panel
 - On the dashboard
 - In front of the Remote Touch screen
- Secure all items in the occupant compartment.

■ Capacity and distribution

- Do not exceed the maximum axle weight rating or the total vehicle weight rating.
- Even if the total load of occupant's weight and the cargo load is less than the total load capacity, do not apply the load unevenly. Improper loading may cause deterioration of steering or braking control which may cause death or serious injury.

Vehicle load limits

Vehicle load limits include total load capacity, seating capacity, towing capacity and cargo capacity.

◆ Total load capacity (vehicle capacity weight): (→P. 550)

Total load capacity means the combined weight of occupants, cargo and luggage.

◆ Seating capacity:

5-seat models

5 occupants (Front 2, Rear 3)

4-seat models

4 occupants (Front 2, Rear 2)

Seating capacity means the maximum number of occupants whose estimated average weight is 150 lb. (68 kg) per person.

◆ Towing capacity

Lexus does not recommend towing a trailer with your vehicle.

◆ Cargo capacity

Cargo capacity may increase or decrease depending on the weight and the number of occupants.

■ Total load capacity and seating capacity

These details are also described on the tire and loading information label. (→P. 475)

⚠ CAUTION

■ Overloading the vehicle

Do not overload the vehicle.

It may not only cause damage to the tires, but also degrade steering and braking ability, resulting in an accident.

Trailer towing

Lexus does not recommend towing a trailer with your vehicle. Lexus also does not recommend the installation of a tow hitch or the use of a tow hitch carrier for a wheelchair, scooter, bicycle, etc. Your vehicle is not designed for trailer towing or for the use of tow hitch mounted carriers.



تلفن شبانه روزی: ۰۲۱-۸۸۸۶۲۰۸۵

FarmaSOS.com

Dinghy towing

Your vehicle is not designed to be dinghy towed (with 4 wheels on the ground) behind a motor home.

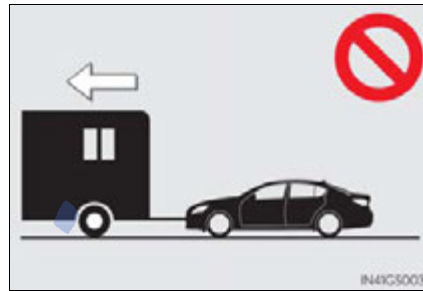

⚠ NOTICE

■ To avoid serious damage to your vehicle

Do not tow your vehicle with the four wheels on the ground.

4

Driving

تلفن شبانه روزی: ۰۲۱-۸۸۸۶۲۰۸۵

FarmaSOS.com

Engine (ignition) switch

Performing the following operations when carrying the electronic key on your person starts the engine or changes engine switch modes.

Starting the engine

- 1 Turn the engine switch to IGNITION ON mode (→P. 209) and check that the parking brake is set.
- 2 Check that the shift lever is set in P.
- 3 Firmly depress the brake pedal.

The engine switch indicator will turn green. If the indicator does not turn green, the engine cannot be started.

- 4 Press the engine switch.

The engine will crank until it starts or for up to 30 seconds, whichever is less.

Continue depressing the brake pedal until the engine is completely started.

The engine can be started from any engine switch mode.



Stopping the engine

- 1 Stop the vehicle.
- 2 Shift the shift lever to P.
- 3 Set the parking brake. (→P. 225)
- 4 Press the engine switch.
- 5 Release the brake pedal and check that the indicator on the engine switch is off.

Changing engine switch modes

Modes can be changed by pressing the engine switch with brake pedal released. (The mode changes each time the switch is pressed.)

- ① Off*
The emergency flashers can be used.
- ② ACCESSORY mode
Some electrical components such as the audio system can be used.
The engine switch indicator turns amber.
- ③ IGNITION ON mode
All electrical components can be used.
The engine switch indicator turns amber.

*: If the shift lever is in a position other than P when turning off the engine, the engine switch will be turned to ACCESSORY mode, not to off.

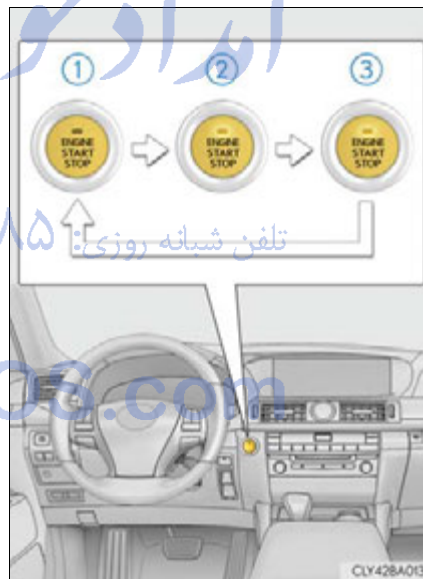

■ **Auto power off function**

If the vehicle is left in ACCESSORY mode for more than 20 minutes with the shift lever in P, the engine switch will automatically turn off.

■ **Electronic key battery depletion**

→P. 125

■ **Conditions affecting operation**

→P. 122

■ **Notes for the entry function**

→P. 123

■ **If the engine does not start**

The engine immobilizer system may not have been deactivated. (→P. 78)
Contact your Lexus dealer.

■ **Steering lock**

After turning the engine switch off and opening and closing the doors, the steering wheel will be locked due to the steering lock function. Operating the engine switch again automatically cancels the steering lock.

■ **When the steering lock cannot be released**

The green indicator light on the engine switch will flash and a message will be shown on the multi-information display. Press the engine switch again while turning the steering wheel left and right.

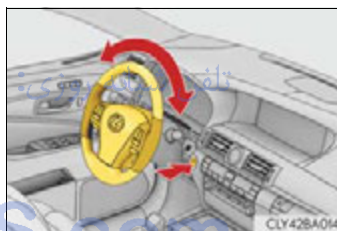

■ **Steering lock motor overheating prevention**

To prevent the steering lock motor from overheating, the motor may be suspended if the engine is turned on and off repeatedly in a short period of time. In this case, refrain from operating the engine. After about 10 seconds, the steering lock motor will resume functioning.

■ **When the engine switch indicator flashes in amber**

The system may be malfunctioning. Have the vehicle inspected by your Lexus dealer immediately.

■ **If the electronic key battery is depleted**

→P. 483

■ **If the smart access system with push-button start has been deactivated in a customized setting**

→P. 536

 **CAUTION**

■ **When starting the engine**

Always start the engine while sitting in the driver's seat. Do not depress the accelerator pedal while starting the engine under any circumstances. Doing so may cause an accident resulting in death or serious injury.

■ **Caution while driving**

If engine failure occurs while the vehicle is moving, do not lock or open the doors until the vehicle reaches a safe and complete stop. Activation of the steering lock in this circumstance may lead to an accident, resulting in death or serious injury.

■ **Stopping the engine in an emergency**

If you want to stop the engine in an emergency while driving the vehicle, press and hold the engine switch for more than 2 seconds, or press it briefly 3 times or more in succession. (→P. 495)

However, do not touch the engine switch while driving except in an emergency. Turning the engine off while driving will not cause loss of steering or braking control, however, power assist to the steering will be lost. This will make it more difficult to steer smoothly, so you should pull over and stop the vehicle as soon as it is safe to do so.

 NOTICE**■ To prevent battery discharge**

Do not leave the engine switch in ACCESSORY or IGNITION ON mode for long periods of time without the engine running.

■ When starting the engine

- Do not race a cold engine.
- If the engine becomes difficult to start or stalls frequently, have your vehicle checked by your Lexus dealer immediately.

■ Symptoms indicating a malfunction with the engine switch

If the engine switch seems to be operating somewhat differently than usual, such as the switch sticking slightly, there may be a malfunction. Contact your Lexus dealer immediately.

امداد خودرو فارما

تلفن شبانه روزی: ۰۲۱-۸۸۸۶۲۰۸۵

FarmaSOS.com

Automatic transmission (except 2WD models with paddle shift switches)

Shifting the shift lever

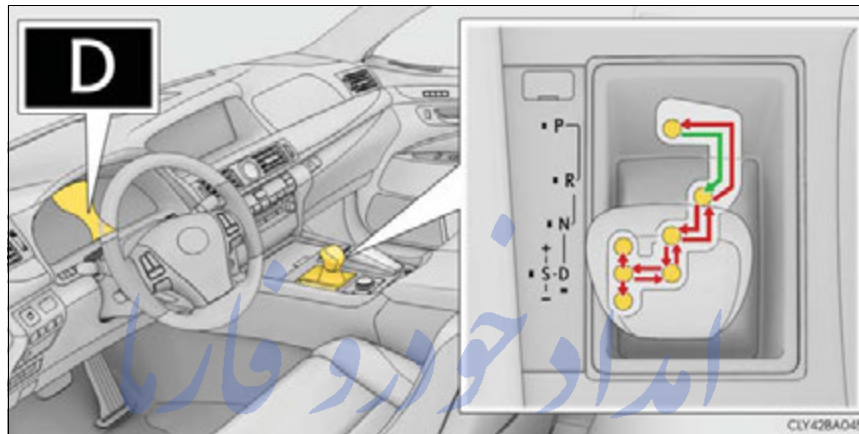

- ← While the engine switch is in IGNITION ON mode, move the shift lever with the brake pedal depressed.

When shifting the shift lever between P and D, make sure that the vehicle is completely stopped.

Shift position purpose

Shift position	Purpose and condition
P	Parking the vehicle/starting the engine
R	Reversing
N	Condition in which the power is not transmitted
D	Normal driving*
S	S mode driving (→P. 215)

*: To improve fuel efficiency and reduce noises, set the shift lever in D for normal driving.

Selecting shift ranges in the D position (AWD models with paddle shift switches)

To drive using temporary shift range selection, operate the “-” or “+” paddle shift switch while the shift lever is in the D position.

Changing the shift range allows restriction of the highest gear, preventing unnecessary upshifting and enabling the level of engine braking force to be selected.

When the “-” paddle shift switch is operated, the shift range is downshifted to a range that enables engine braking force that is suitable to driving conditions.

① Upshifting

② Downshifting

The selected shift range, from D1 to D8, will be displayed in the meter.

To return to normal D position driving, the “+” paddle shift switch must be held down for a period of time.

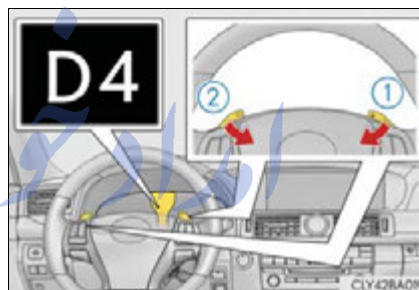

■ Shift ranges and their functions

Meter display	Function
D2 - D8	A gear in the range between 1 and the selected gear is automatically chosen depending on vehicle speed and driving conditions
D1	Setting the gear at 1

A lower shift range will provide greater engine braking forces than a higher shift range.

Selecting shift ranges in S mode

To enter S mode, shift the shift lever to the S position.

When in S mode, changing the shift range allows restriction of the highest gear, preventing unnecessary upshifting and enabling the level of engine braking force to be selected.

- ① Upshifting
- ② Downshifting

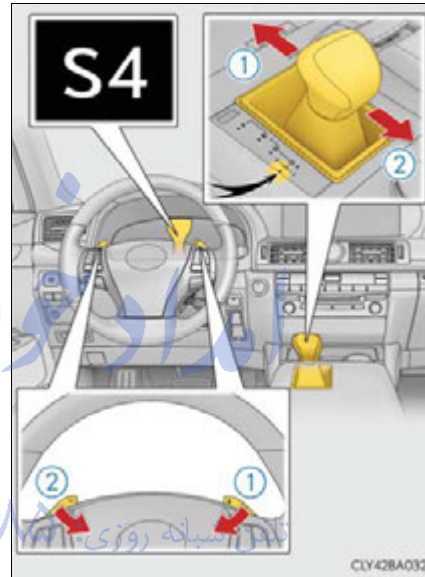

The initial shift range in S mode is set automatically between 3 and 7 according to vehicle speed and driving conditions.

■ Shift ranges and their functions

Meter display	Function
S2 - S8	A gear in the range between 1 and the selected gear is automatically chosen depending on vehicle speed and driving conditions
S1	Setting the gear at 1

A lower shift range will provide greater engine braking forces than a higher shift range.

Selecting the driving mode

■ Sport mode/Comfort mode/Eco drive mode

→P. 281

■ Snow mode

Snow mode can be selected to suit the conditions when driving on slippery road surfaces, such as on snow.

Press the switch.

The snow mode indicator light will come on.

Press the switch again to return to normal mode.



■ Automatic deactivation of shift range selection in the D position (AWD models with paddle shift switches)

Shift range selection in the D position will be deactivated in the following situations:

- When the vehicle comes to a stop
- If the accelerator pedal is depressed for more than a certain period of time
- When the shift lever is shifted to other than D

■ S mode

- When the shift range is 6 or lower, holding the shift lever toward "+" sets the shift range to 8.
- When the shift lever is moved toward "-", the shift range is downshifted to a range that enables engine braking force that is suitable to driving conditions.
- To prevent the engine from over-revving, upshifting may automatically occur.

■ Downshifting restrictions warning buzzer

To help ensure safety and driving performance, downshifting operation may sometimes be restricted. In some circumstances, downshifting may not be possible even when the shift lever or paddle shift switch (AWD models with paddle shift switches) is operated. (A buzzer will sound twice.)

■ **When driving with cruise control or dynamic radar cruise control with full speed range activated**

Even when performing the following actions with the intent of enabling engine braking, engine braking will not activate because cruise control or dynamic radar cruise control with full speed range will not be canceled.

- While driving in D or S mode, downshifting to 7, 6, 5 or 4. (→P. 250, 254)
- When switching the driving mode to sport mode while driving in D position. (→P. 281)

■ **Snow mode automatic deactivation**

Snow mode is automatically deactivated if the engine switch is turned off after driving in snow mode.

■ **If the shift lever cannot be shifted from P**

→P. 531

■ **AI-SHIFT**

The AI-SHIFT automatically selects the suitable gear according to driver performance and driving conditions.

The AI-SHIFT automatically operates when the shift lever is in the D and S position.

⚠ CAUTION

■ **When driving on slippery road surfaces**

Be careful of downshifting and sudden acceleration, as this could result in the vehicle skidding to the side or spinning.

Automatic transmission (2WD models with paddle shift switches)

Shifting the shift lever

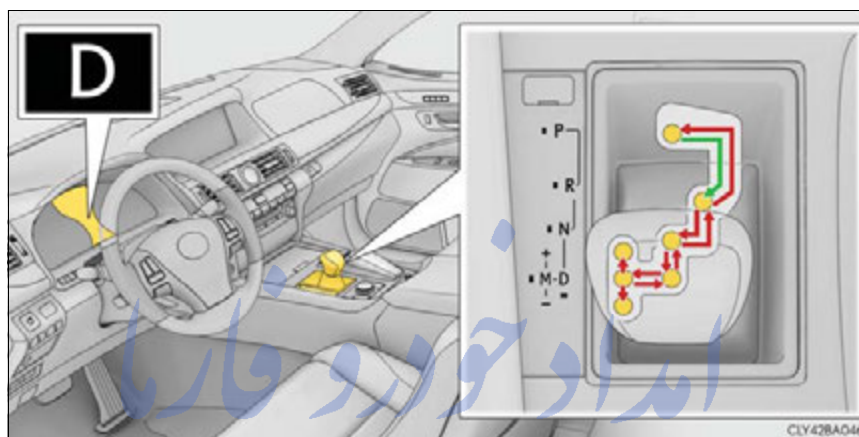

- ← While the engine switch is in IGNITION ON mode, move the shift lever with the brake pedal depressed.

When shifting the shift lever between P and D, make sure that the vehicle is completely stopped.

FarmaSOS.com

Shift position purpose

Shift position	Meter display	Purpose and condition
P	P	Parking the vehicle/starting the engine
R	R	Reversing
N	N	Condition in which the power is not transmitted
D	D	Normal driving ^{*1}
	D4 (paddle shift switches activated)	Shift range selection (→P. 220)
M	M4	M mode driving ^{*2} (→P. 221)

*1: To improve fuel efficiency and reduce noises, set the shift lever in D for normal driving.

*2: Any gear can be fixed when driving in M mode. *تلفن شبانه روزی: ۰۲۱-۸۸۶۲۰۸۸*

Selecting shift ranges in the D position

To drive using temporary shift range selection, operate the “-” or “+” paddle shift switch while the shift lever is in the D position.

Changing the shift range allows restriction of the highest gear, preventing unnecessary upshifting and enabling the level of engine braking force to be selected.

When the “-” paddle shift switch is operated, the shift range is downshifted to a range that enables engine braking force that is suitable to driving conditions.

- ① Upshifting
- ② Downshifting

The selected shift range, from D1 to D8, will be displayed in the meter.

To return to normal D position driving, the “+” paddle shift switch must be held down for a period of time.

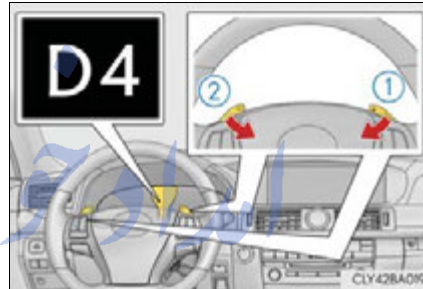

■ Shift ranges and their functions

Meter display	Function
D2 - D8	A gear in the range between 1 and the selected gear is automatically chosen depending on vehicle speed and driving conditions
D1	Setting the gear at 1

A lower shift range will provide greater engine braking forces than a higher shift range.

Selecting gears in the M position

To enter M mode, shift the shift lever to the M position.

Gears can be selected by operating the shift lever or paddle shift switches, allowing you to drive in the gear of your choosing.

① Upshifting

② Downshifting

The gear changes once every time the shift lever or paddle shift switch is operated.

The selected gear, from M1 to M8, will be fixed and displayed in the meter.

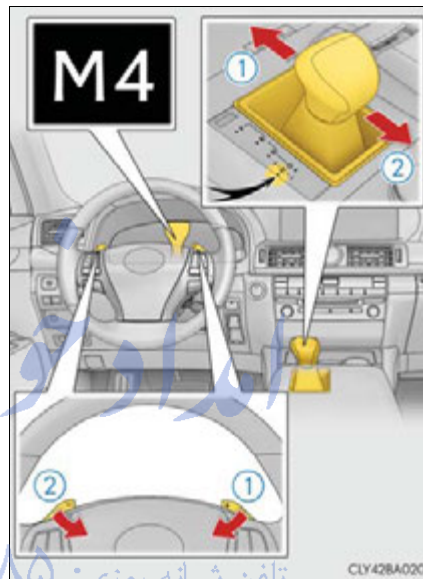

- When in the M position, the gear will not change unless the shift lever or paddle shift switches are operated. However, even when in the M position, the gears will be automatically changed in the following situation:
 - When vehicle speed drops (downshift only).
 - When the automatic transmission fluid or engine coolant temperature is low.
 - When the automatic transmission fluid temperature is high.
 - When the needle of the tachometer is in the red zone (the range which exceeds the allowable revs of the engine).
- When in the vehicle speed is low, the gear will not upshift even if the shift lever or paddle shift switches are operated.

Selecting the driving mode

■ Sport mode/Comfort mode/Eco drive mode

→P. 281

■ Snow mode

Snow mode can be selected to suit the conditions when driving on slippery road surfaces, such as on snow.

Press the switch.

The snow mode indicator light will come on.

Press the switch again to return to normal mode.



■ Automatic deactivation of shift range selection in the D position

Shift range selection in the D position will be deactivated in the following situations:

- When the vehicle comes to a stop
- If the accelerator pedal is depressed for more than a certain period of time
- When the shift lever is shifted to other than D

■ Downshifting restrictions warning buzzer

To help ensure safety and driving performance, downshifting operation may sometimes be restricted. In some circumstances, downshifting may not be possible even when the shift lever or paddle shift switch is operated. (A buzzer will sound twice.)

■ **When driving with cruise control or dynamic radar cruise control with full speed range activated**

Even when performing the following actions with the intent of enabling engine braking, engine braking will not activate because cruise control or dynamic radar cruise control with full speed range will not be canceled.

- While driving in the D position, downshifting to 7, 6, 5 or 4. (→P. 250, 254)
- When switching the driving mode to sport mode while driving in D position. (→P. 281)

■ **Snow mode automatic deactivation**

Snow mode is automatically deactivated if the engine switch is turned off after driving in snow mode.

■ **If the shift lever cannot be shifted from P**

→P. 531

■ **If the automatic transmission fluid temperature warning message is displayed**

If the automatic transmission fluid temperature warning message is displayed while driving, make sure you return to normal D position driving and reduce speed by easing off the accelerator pedal. Stop the vehicle in a safe place, shift the shift lever to the P position and let the engine idle until the warning message goes out.

When the warning message goes out, the vehicle can be driven again.

If the warning message does not go out after waiting a while, have your vehicle inspected by your Lexus dealer.

■ **AI-SHIFT**

The AI-SHIFT automatically selects the suitable gear according to driver performance and driving conditions.

The AI-SHIFT automatically operates when the shift lever is in the D position. (Shifting the shift lever to the M position cancels the function.)

 **CAUTION**

■ **When driving on slippery road surfaces**

Be careful of downshifting and sudden acceleration, as this could result in the vehicle skidding to the side or spinning.

Turn signal lever

Operating instructions

- ① Right turn
- ② Lane change to the right (move the lever partway and release it)
The right hand signals will flash 3 times.
- ③ Lane change to the left (move the lever partway and release it)
The left hand signals will flash 3 times.
- ④ Left turn

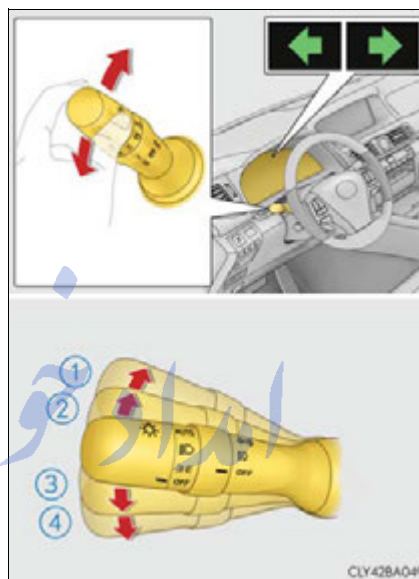

■ Turn signals can be operated when

The engine switch is in IGNITION ON mode.

■ If the indicator flashes faster than usual

Check that a light bulb in the front or rear turn signal lights has not burned out.

■ If the turn signals stop flashing before a lane change has been performed

Operate the lever again.

■ To discontinue flashing of the turn signals during a lane change

Operate the lever in the opposite direction.

■ Customization

The number of times the turn signals flash during a lane change can be changed.
(Customizable features →P. 577)

Parking brake

A selections can be made as desired from the following modes.

Manual mode

- ① Sets the parking brake
The parking brake indicator light will come on. (→P. 227)
Press and hold the parking brake switch if an emergency occurs and it is necessary to operate the parking brake while driving. The parking brake is applied only while the switch is being pressed.
- ② Releases the parking brake
Operate the parking brake switch while depressing the brake pedal. Make sure that the parking brake indicator light goes off.

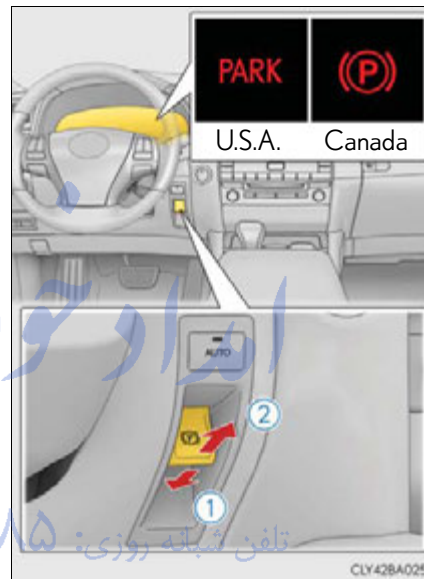

4

Driving

FarmaSOS.com

Automatic mode

The parking brake is set or released automatically according to shift lever operation.

Turns automatic mode on/off

When automatic mode is turned on, the indicator on the switch comes on and it operates in the following manner:

- When the shift lever is moved into P, the parking brake will be set.
- When the shift lever is moved out of P, the parking brake will be released.

Operate the shift lever with the brake pedal depressed.



■ Parking brake operation

- When the engine switch is not in IGNITION ON mode, the parking brake cannot be released using the parking brake switch.
- When the engine switch is not in IGNITION ON mode, automatic mode (automatic brake setting and releasing) is not available.
- If the parking brake is operated repeatedly over a short period of time, the system may restrict operation to prevent overheating. If this happens, refrain from operating the parking brake. Normal operation will return after about 1 minute.

■ Parking brake operation sound

When the parking brake operates, a motor sound (whirring sound) may be heard. This does not indicate a malfunction.

■ Parking brake indicator light

- Depending on the engine switch mode, the parking brake indicator light will come on and stay on as described below:
IGNITION ON mode: Comes on until the parking brake is released.
Not in IGNITION ON mode: Stays on for approximately 15 seconds.
- When the engine switch is turned off with the parking brake set, the parking brake indicator light will stay on for about 15 seconds. This does not indicate a malfunction.

■ Parking brake engaged warning buzzer

A buzzer will sound if the vehicle is driven at a speed of approximately 3 mph (5 km/h) or more with the parking brake engaged.

■ When there is a malfunction in the system

Warning lights and/or warning message will turn on or flash. (→P. 506, 514)
Depending on the condition, the parking brake indicator light may flash.

■ Usage in winter time

→P. 322

NOTICE

■ When parking the vehicle

Before you leave the vehicle, set the parking brake, shift the shift lever to P and make sure that the vehicle does not move.

■ When the system malfunctions

Stop the vehicle in a safe place and check the warning messages.

■ When the parking brake cannot be released due to a malfunction

Use the parking brake release tool to manually release the parking brake. (→P. 532)

Driving the vehicle with the parking brake set will lead to brake components overheating, which may affect braking performance and increase brake wear.

Brake Hold

The brake hold system keeps the brake applied when the shift lever is in D, N, or S (except 2WD models with paddle shift switches) or M (2WD models with paddle shift switches) with the system on and the brake pedal has been depressed to stop the vehicle. The system releases the brake when the accelerator pedal is depressed with the shift lever in D, S or M to allow smooth start off.

Turns the brake hold system on

The brake hold standby indicator (green) comes on. While the system is holding the brake, the brake hold operated indicator (yellow) comes on.

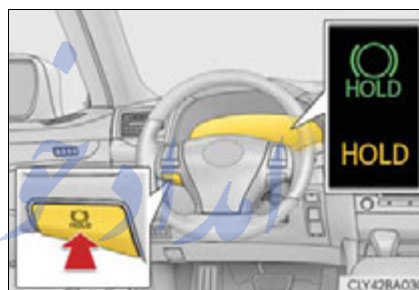

■ Brake hold system operating conditions

The brake hold system cannot be turned on in the following conditions:

- The trunk or hood is not closed.
- The driver's door is not closed.
- The driver is not wearing the seat belt.

If any of the conditions above are detected when the brake hold system is enabled, the system will turn off and the brake hold standby indicator light will go off. In addition, if any of the conditions are detected while the system is holding the brake, a warning buzzer will sound and a message will be shown on the multi-information display. The parking brake will then be set automatically.

■ Brake hold function

- If the brake pedal is left released for a period of about 3 minutes after the system has started holding the brake, the parking brake will be set automatically. In this case, a warning buzzer sounds and a message is shown on the multi-information display.
- To turn the system off while the system is holding the brake, firmly depress the brake pedal and press the switch again.
- The brake hold function may not hold the vehicle when the vehicle is on a steep incline. In this situation, it may be necessary for the driver to apply the brakes. The multi-information display will inform the driver of this situation.

■ When the parking brake is set automatically while the system is holding the brakes

The parking brake will not be released automatically. Release the parking brake by operating the parking brake switch, making sure that the parking brake indicator light goes off. (→P. 225)

■ When there is a malfunction in the system

Warning lights and/or warning messages will turn on or flash. (→P. 506, 514)

⚠ CAUTION

■ When the vehicle is on a steep incline

When using the brake hold system on a steep incline exercise caution. The brake hold function may not hold the vehicle in such a situation.

■ When stopped on a slippery road

The system cannot stop the vehicle when the gripping ability of the tires has been exceeded. Do not use the system when stopped on a slippery road.

⚠ NOTICE

■ When parking the vehicle

The brake hold system is not designed for use when parking the vehicle for a long period of time. Turning the engine switch off while the system is holding the brake may release the brake, which would cause the vehicle to move. When operating the engine switch, depress the brake pedal, set the parking brake and shift the shift lever to P.

Horn

To sound the horn, press on or close to the  mark.



امداد خودرو فارما

تلفن شبانه روزی: ۰۲۱-۸۸۸۶۲۰۸۵

FarmaSOS.com

Headlight switch

The headlights can be operated manually or automatically.

Operating instructions

Turning the end of the lever turns on the lights as follows:

- ① OFF (U.S.A.) or ○ (Canada)
The daytime running lights turn on. (→P. 233)
- ② ☰ The side marker, tail, license plate, instrument panel and daytime running lights (→P. 233) turn on.
- ③ ☰ The headlights, parking lights and all lights listed (except daytime running lights) above turn on.
- ④ AUTO The headlights, parking lights, daytime running lights (→P. 233) and all the lights listed above turn on and off automatically.
(When the engine switch is in IGNITION ON mode.)

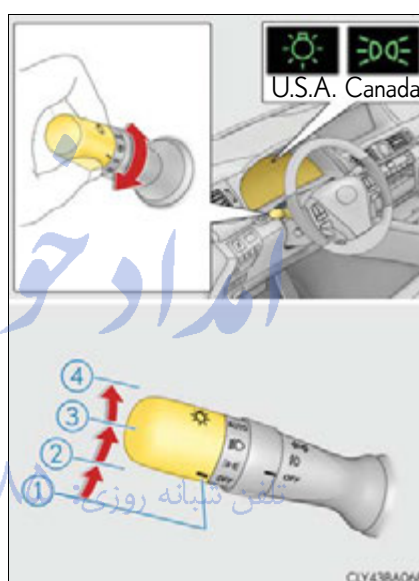

Turning on the high beam headlights

- ① With the headlights on, push the lever away from you to turn on the high beams.

Pull the lever toward you to the center position to turn the high beams off.

- ② Pull the lever toward you and release it to flash the high beams once.

You can flash the high beams with the headlights on or off.

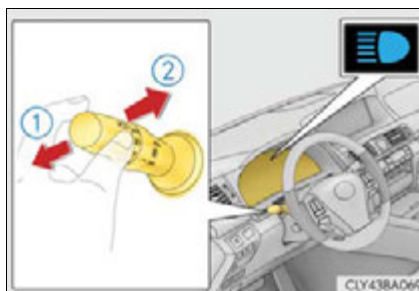

AFS (Adaptive Front-lighting System)

AFS (Adaptive Front-lighting System) secures excellent visibility at intersections and on curves by automatically adjusting the direction of the light axis of the headlights according to vehicle speed and the degree of the tire's angle as controlled by steering input.

AFS operates at speeds of 6 mph (10 km/h) or higher. تلفن شبانه روزی ۰۲۱۳۸۳۳۸۳۰۰

FarmaSOS.com

■ Daytime running light system

- To make your vehicle more visible to other drivers during daytime driving, the daytime running lights turn on automatically whenever the engine is started and the parking brake is released with the headlight switch off or in the **AUTO** position. (Illuminate brighter than the parking lights.)

Daytime running lights are not designed for use at night.

- Compared to turning on the headlights, the daytime running light system offers greater durability and consumes less electricity, so it can help improve fuel economy.

■ Headlight control sensor



The sensor may not function properly if an object is placed on the sensor, or anything that blocks the sensor is affixed to the windshield.

Doing so interferes with the sensor detecting the level of ambient light and may cause the automatic headlight system to malfunction.



■ Automatic light off system

- When the headlights are on: The headlights and tail lights turn off 30 seconds after a door is opened and closed if the engine switch is turned to **ACCESSORY** mode or turned off. (The lights turn off immediately if  on the key is pressed after all the doors are closed.)
- When only the tail lights are on: The tail lights turn off automatically if the engine switch is turned to **ACCESSORY** mode or turned off and the driver's door is opened.

To turn the lights on again, turn the engine switch to **IGNITION ON** mode, or turn the light switch off once and then back to  or .

If any of the doors or trunk lid is kept open, the lights automatically turn off after 20 minutes.

■ Light reminder buzzer

A buzzer sounds when the engine switch is turned off or turned to **ACCESSORY** mode and the driver's door is opened while the lights are turned on.

■ Automatic headlight leveling system

The level of the headlights is automatically adjusted according to the number of passengers and the loading condition of the vehicle to ensure that the headlights do not interfere with other road users.

■ **Battery-saving function**

In the following conditions, the remaining lights will go off automatically after 20 minutes in order to prevent the vehicle battery from being discharged:

- The headlights and/or tail lights are on.
- The engine switch is turned to ACCESSORY mode or turned off.

This function will be canceled in any of the following situations:

- When the engine switch is turned to IGNITION ON mode.
- When the light switch is operated.
- When the door or trunk is opened or closed.

■ **Customization**

Settings (e.g. light sensor sensitivity) can be changed.
(Customizable features →P. 577)

 NOTICE

■ **To prevent battery discharge**

Do not leave the lights on longer than necessary when the engine is not running.

تلفن شبانه روزی: ۰۲۱-۸۸۸۶۲۰۸۵

FarmaSOS.com

Automatic High Beam*

The Automatic High Beam uses an in-vehicle camera sensor to assess the brightness of streetlights, the lights of oncoming and preceding vehicles, etc., and automatically turns high beam on or off as necessary.

Activating the Automatic High Beam system

- 1 Push the lever away from you with the headlight switch in AUTO or  position.

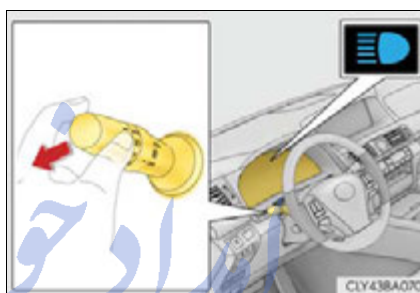

- 2 Press the Automatic High Beam switch.

The Automatic High Beam indicator will come on when the headlights are turned on automatically to indicate that the system is active.

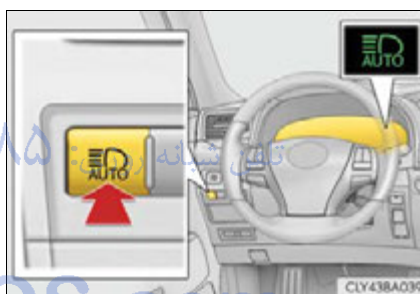

4

Driving

*: If equipped

Turning the high beam on/off manually

■ Switching to low beam

Pull the lever to original position.

The Automatic High Beam indicator will turn off.

Push the lever away from you to activate the Automatic High Beam system again.

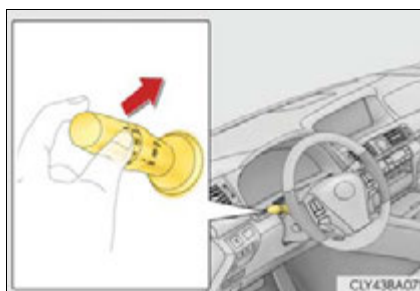

■ Switching to high beam

Press the Automatic High Beam switch.

The Automatic High Beam indicator will turn off and the high beam indicator will turn on.

Press the switch to activate the Automatic High Beam system again.

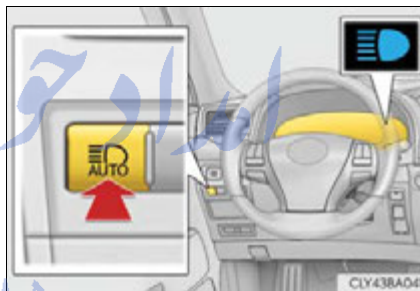

High beam automatic turning on or off conditions

- When all of the following conditions are fulfilled, high beam will be automatically turned on (after approximately 1 second):
 - Vehicle speed is above approximately 21 mph (34 km/h).
 - The area ahead of the vehicle is dark.
 - There are no oncoming or preceding vehicles with headlights or tail lights turned on.
- If any of the following conditions are fulfilled, high beam will be automatically turned off:
 - Vehicle speed drops below approximately 17 mph (27 km/h).
 - The area ahead of the vehicle is not dark.
 - Oncoming or preceding vehicles have headlights or tail lights turned on.

■ The Automatic High Beam can be operated when

The engine switch is in IGNITION ON mode.

■ Camera sensor detection information

- High beam may not be automatically turned off in the following situations:
 - When oncoming vehicles suddenly appear from a curve
 - When the vehicle is cut in front of by another
 - When oncoming or preceding vehicles are hidden from sight due to repeated curves, road dividers or roadside trees
- High beam may be turned off if an oncoming vehicle that is using fog lights without using the headlights is detected.
- House lights, street lights, red traffic signals, and illuminated billboards or signs may cause the high beam to turn off.
- The following factors may affect the amount of time taken to turn high beam on or off:
 - The brightness of headlights, fog lights, and tail lights of oncoming and preceding vehicles
 - The movement and direction of oncoming and preceding vehicles
 - When a oncoming or preceding vehicle only has operational lights on one side
 - When a oncoming or preceding vehicle is a two-wheeled vehicle
 - The condition of the road (gradient, curve, condition of the road surface etc.)
 - The number of passengers and amount of luggage
- High beam may be turned on or off when unexpected by the driver.
- Small vehicles, such as bicycles, may not be detected.

- In the situations below, the system may not be able to correctly detect the surrounding brightness levels, and may flash or expose oncoming or preceding vehicles to the high beam or may continue using the low beam. Therefore, in these situations you should consider turning the high beams on or off manually rather than relying on the Automatic High Beam system.
 - In bad weather (rain, snow, fog, sandstorms etc.)
 - The windshield is obscured by fog, mist, ice, dirt etc.
 - The windshield is cracked or damaged.
 - The inside rear view mirror or camera sensor is deformed or dirty.
 - The camera sensor temperature is extremely high.
 - Surrounding brightness levels are equal to those of headlights, tail lights or fog lights.
 - Vehicles ahead have headlights that are either switched off, dirty, are changing color, or have are not aimed properly.
 - When driving through an area of intermittently changing brightness and darkness.
 - When frequently and repeatedly driving ascending/descending roads, or roads with rough, bumpy or uneven surfaces (such as stone-paved roads, gravel tracks etc.).
 - When frequently and repeatedly taking curves or driving on a winding road.
 - There is a highly reflective object ahead of the vehicle, such as a sign or a mirror.
 - The back of a vehicle ahead is highly reflective, such as a container on a truck.
 - The vehicle's headlights are damaged or dirty.
 - The vehicle is listing or tilting, due to a flat tire, a trailer being towed etc.

■ Temporary lowering sensor sensitivity

The sensitivity of the sensor can be temporarily lowered.

To lower the sensitivity, push and hold the "AUTO" button on the inside rear view mirror for 15 to 20 seconds, and release. The indicator light on the inside rear view mirror will flash to indicate that the sensitivity has been lowered.

When the engine switch is turned off, the sensitivity will be returned to its normal level.

⚠ CAUTION

■ Limitations of the Automatic High Beam

Do not rely on the Automatic High Beam. Always drive safely, taking care to observe your surroundings and turn the high beam on or off manually if necessary.

 NOTICE

■ Notes when using the Automatic High Beam system

Observe the following to ensure that the Automatic High Beam functions correctly.



- Do not touch the camera sensor.
- Do not subject the inside rear view mirror or the camera sensor to a strong impact.
- Do not disassemble the camera sensor.
- Do not spill liquid onto the inside rear view mirror or the camera sensor.
- Do not apply window tinting or stickers to the camera sensor or the area of windshield near the camera sensor.
- Do not place items on the dashboard. There is a possibility that the camera sensor will mistake items reflected in the windshield for streetlights, the headlights of other vehicles, etc.
- Do not install a parking tag or any other accessories near or around the inside rear view mirror and the camera sensor.
- Do not overload the vehicle.
- Do not modify the vehicle.
- If the windshield needs to be replaced, contact your Lexus dealer.

Fog light switch

The fog lights secure excellent visibility in difficult driving conditions, such as in rain and fog.

- ① OFF (U.S.A.) or ○ (Canada)
Turns the front fog lights off
- ②  Turns the front fog lights on

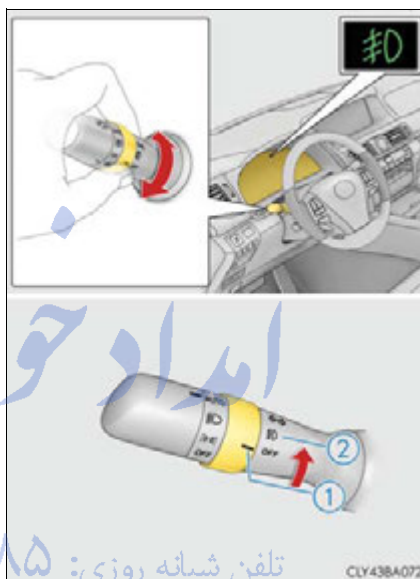

■ Fog lights can be used when

The headlights are on in low beam.

Windshield wipers and washer

Operating the wiper lever

Operate the lever as follows to operate the wipers.

- ① **MIST** (U.S.A.) or **△** (Canada)

Temporary operation

- ② **AUTO** Rain-sensing wiper operation

The wipers will operate automatically when the sensor detects falling rain. The system automatically adjusts wiper timing in accordance with rain volume and vehicle speed.

- ③ **LO** (U.S.A.) or **▼** (Canada)

Low speed wiper operation

- ④ **HI** (U.S.A.) or **▼▼** (Canada)

High speed wiper operation

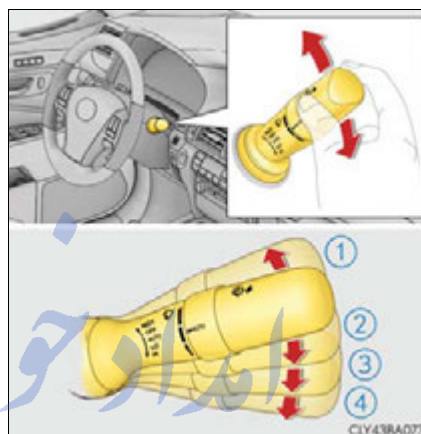

When "AUTO" mode is selected, the sensor sensitivity can be adjusted by turning the switch ring.

- ⑤ Increases the sensitivity
- ⑥ Decreases the sensitivity

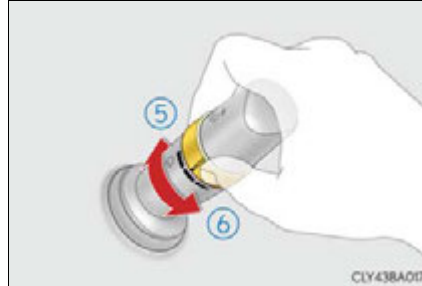

- ⑦ Washer/wiper dual operation

Wipers will automatically operate a couple of times after the washer squirts.

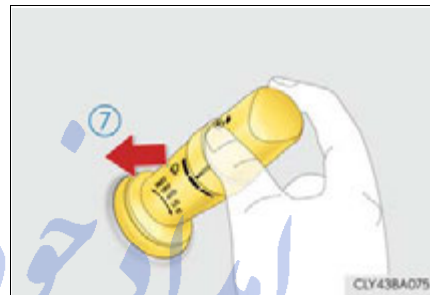

■ The windshield wiper and washer can be operated when

The engine switch is in IGNITION ON mode.

■ Dripping prevention wiper sweep

After washing and the wiper has operated several times, the wipers operate one more time after a short delay to prevent dripping.

However, the last sweep will not happen if the vehicle is traveling above 106 mph (170 km/h).

■ Effects of vehicle speed on wiper operation

Even when the wipers are not in "AUTO" mode, vehicle speed affects the time until the drip prevention wiper sweep occurs.

With low speed windshield wiper operation selected, wiper operation will be switched from low speed to intermittent wiper operation only when the vehicle is stationary.

(However, when the sensor sensitivity is adjusted to the highest level, the mode cannot be switched.)

■ Raindrop sensor

- The raindrop sensor judges the amount of raindrops.

An optical sensor is adopted. It may not operate properly when sunlight from the rising or setting of the sun intermittently strikes the windshield, or if bugs etc. are present on the windshield.



- If the wiper is turned to "AUTO" mode while the engine switch is in IGNITION ON mode, the wipers will operate once to show that "AUTO" mode is activated.
- If the temperature of the raindrop sensor is 194°F (90°C) or higher, or 5°F (-15°C) or lower, automatic operation may not occur. In this case, operate the wipers in any mode other than "AUTO" mode.

■ If no windshield washer fluid sprays

Check that the washer nozzles are not blocked if there is washer fluid in the windshield washer fluid reservoir.

■ Outside rear view mirror defogger activation linked to windshield wiper operation

The outside rear view mirror defoggers automatically turn on when you operate the windshield wipers.

The outside rear view mirror defoggers automatically turn off approximately 15 minutes after the wipers stop.

For details about the outside rear view mirror defoggers: →P.359 تلفن

⚠ CAUTION

■ Caution regarding the use of windshield wipers in "AUTO" mode

The windshield wipers may operate unexpectedly if the sensor is touched or the windshield is subject to vibration in "AUTO" mode. Take care that your fingers or anything else do not become caught in the windshield wipers.

■ Caution regarding the use of washer fluid

When it is cold, do not use the washer fluid until the windshield becomes warm. The fluid may freeze on the windshield and cause low visibility. This may lead to an accident, resulting in death or serious injury.

 NOTICE**■ When the windshield is dry**

Do not use the wipers, as they may damage the windshield.

■ When there is no washer fluid spray from the nozzle

Damage to the washer fluid pump may be caused if the lever is pulled toward you and held continually.

■ When a nozzle becomes blocked

In this case, contact your Lexus dealer.

Do not try to clear it with a pin or other object. The nozzle will be damaged.

امداد خودرو فارما

تلفن شبانه روزی: ۰۲۱-۸۸۸۶۲۰۸۵

FarmaSOS.com

Headlight cleaner switch*

Washer fluid can be sprayed on the headlights.

Press the switch to clean the headlights.

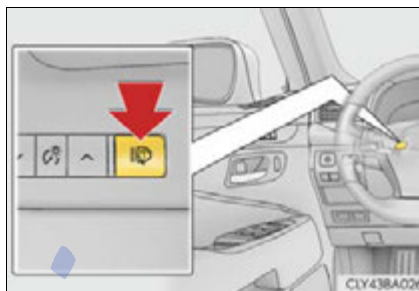

■ The headlight cleaners can be operated when

The engine switch is in IGNITION ON mode and the headlight switch is turned on.

■ Windshield washer linked operation

When the windshield washer is operated with the engine switch in IGNITION ON mode and the headlights on, the headlight cleaners will operate once. (→P. 241)

⚠ NOTICE

■ When the washer fluid tank is empty

Do not press the switch continually as the washer fluid pump may overheat.

4

Driving

*: If equipped

Opening the fuel tank cap

Perform the following steps to open the fuel tank cap:

Before refueling the vehicle

- Close all the doors and windows, and turn the engine switch off.
- Confirm the type of fuel.

■ Fuel types

→P.563

■ Fuel tank opening for unleaded gasoline

To help prevent incorrect fueling, your vehicle has a fuel tank opening that only accommodates the special nozzle on unleaded fuel pumps.

تلفن شبانه روزی: ۰۲۱-۸۸۶۲۰۸۵

FarmaSOS.com

 CAUTION**■ When refueling the vehicle**

Observe the following precautions while refueling the vehicle. Failure to do so may result in death or serious injury.

- After exiting the vehicle and before opening the fuel door, touch an unpainted metal surface to discharge any static electricity. It is important to discharge static electricity before refueling because sparks resulting from static electricity can cause fuel vapors to ignite while refueling.
- Always hold the grips on the fuel tank cap and turn it slowly to remove it. A whooshing sound may be heard when the fuel tank cap is loosened. Wait until the sound cannot be heard before fully removing the cap. In hot weather, pressurized fuel may spray out the filler neck and cause injury.
- Do not allow anyone that has not discharged static electricity from their body to come close to an open fuel tank.
- Do not inhale vaporized fuel. Fuel contains substances that are harmful if inhaled.
- Do not smoke while refueling the vehicle. Doing so may cause the fuel to ignite and cause a fire.
- Do not return to the vehicle or touch any person or object that is statically charged. This may cause static electricity to build up, resulting in a possible ignition hazard.

■ When refueling

Observe the following precautions to prevent fuel overflowing from the fuel tank:

- Securely insert the fuel nozzle into the fuel filler neck.
- Stop filling the tank after the fuel nozzle automatically clicks off.
- Do not top off the fuel tank.

 NOTICE**■ Refueling**

Do not spill fuel during refueling.

Doing so may damage the vehicle, such as causing the emission control system to operate abnormally or damaging fuel system components or the vehicle's painted surface.

Opening the fuel tank cap

- 1 Press the opener switch.

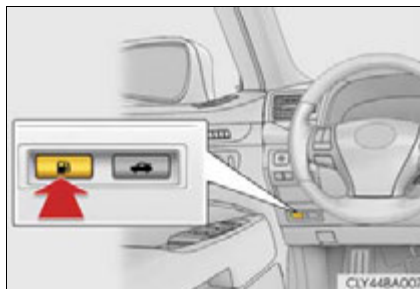

- 2 Turn the fuel tank cap slowly to open.

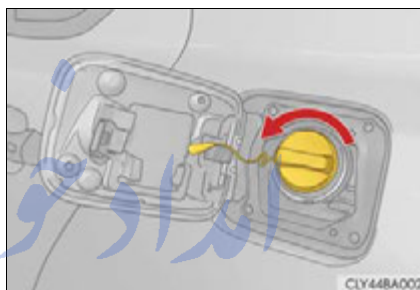

- 3 Hang the fuel tank cap on the back of the fuel filler door.

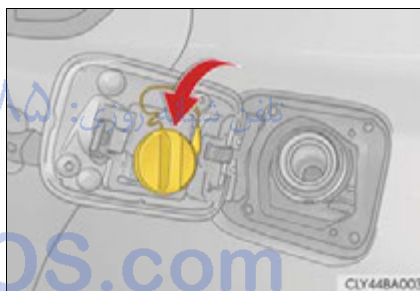

■ **When the fuel filler door cannot be opened by pressing the inside switch**

Remove the cover inside the trunk and pull the lever.



Closing the fuel tank cap

After refueling, turn the fuel tank cap until you hear a click. Once the cap is released, it will turn slightly in the opposite direction.

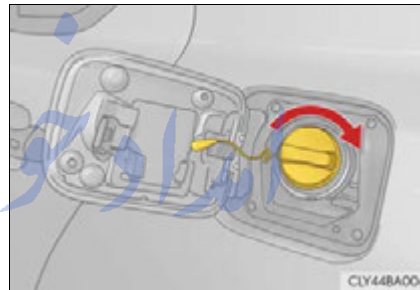

4

Driving

⚠ CAUTION

■ **When replacing the fuel tank cap**

Do not use anything but a genuine Lexus fuel tank cap designed for your vehicle. Doing so may cause a fire or other incident which may result in death or serious injury.

Cruise control*

Summary of functions

Use the cruise control to maintain a set speed without depressing the accelerator pedal.

- ① Indicators
- ② Cruise control switch

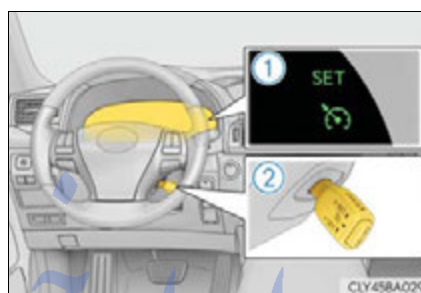

Setting the vehicle speed

- ① Press the “ON•OFF” button to activate the cruise control.

Cruise control indicator will come on.
Press the button again to deactivate the cruise control.



- ② Accelerate or decelerate the vehicle to the desired speed, and push the lever down to set the speed.

“SET” indicator will come on.
The vehicle speed at the moment the lever is released becomes the set speed.



*: If equipped

Adjusting the set speed

To change the set speed, operate the lever until the desired set speed is obtained.

- ① Increases the speed
- ② Decreases the speed

Fine adjustment: Momentarily move the lever in the desired direction.

Large adjustment: Hold the lever in the desired direction.



The set speed will be increased or decreased as follows:

Fine adjustment: By approximately 1 mph (1.6 km/h) each time the lever is operated.

Large adjustment: The set speed can be increased or decreased continually until the lever is released.

Canceling and resuming the constant speed control

- ① Pulling the lever toward you cancels the constant speed control.

The speed setting is also canceled when the brakes are applied.

- ② Pushing the lever up resumes the constant speed control.

Resuming is available when the vehicle speed is more than approximately 25 mph (40 km/h).



■ **Cruise control can be set when**

- The shift lever is in the D or range 4 or higher of S has been selected. (except 2WD models with paddle shift switches)
- The shift lever is in D. (2WD models with paddle shift switches)
- Range 4 or higher of D has been selected by using the paddle shift. (2WD models with paddle shift switches)
- Vehicle speed is above approximately 25 mph (40 km/h).

■ **Accelerating after setting the vehicle speed**

- The vehicle can be accelerated normally. After acceleration, the set speed resumes.
- Even without canceling the cruise control, the set speed can be increased by first accelerating the vehicle to the desired speed and then pushing the lever down to set the new speed.

■ **Automatic cruise control cancelation**

Cruise control will stop maintaining the vehicle speed in any of the following situations.

- Actual vehicle speed falls more than approximately 10 mph (16 km/h) below the preset vehicle speed.
At this time, the memorized set speed is not retained.
- Actual vehicle speed is below approximately 25 mph (40 km/h).
- VSC is activated.
- TRAC is activated for a period of time.
- When the VSC or TRAC system is turned off by pressing the VSC OFF switch.

■ **If the warning message for the cruise control is shown on the multi-information display**

Press the "ON•OFF" button once to deactivate the system, and then press the button again to reactivate the system.

If the cruise control speed cannot be set or if the cruise control cancels immediately after being activated, there may be a malfunction in the cruise control system. Have the vehicle inspected by your Lexus dealer.

⚠ CAUTION**■ To avoid operating the cruise control by mistake**

Switch the cruise control off using the "ON•OFF" button when not in use.

■ Situations unsuitable for cruise control

Do not use cruise control in any of the following situations.

Doing so may result in loss of control and could cause an accident resulting in death or serious injury.

- In heavy traffic
- On roads with sharp bends
- On winding roads
- On slippery roads, such as those covered with rain, ice or snow
- On steep hills

Vehicle speed may exceed the set speed when driving down a steep hill.

تلفن شبانه روزی: ۰۲۱-۸۸۶۲۰۸۵

FarmaSOS.com

Dynamic radar cruise control with full-speed range*

Summary of functions

Dynamic radar cruise control with full-speed range supplements conventional cruise control with a vehicle-to-vehicle distance control. In vehicle-to-vehicle distance control mode, the vehicle automatically accelerates, decelerates or stops in order to maintain a set following distance from vehicles ahead. See cautions on P. 267

- ① Vehicle-to-vehicle distance button
- ② Display
- ③ Set speed
- ④ Indicators
- ⑤ Cruise control switch

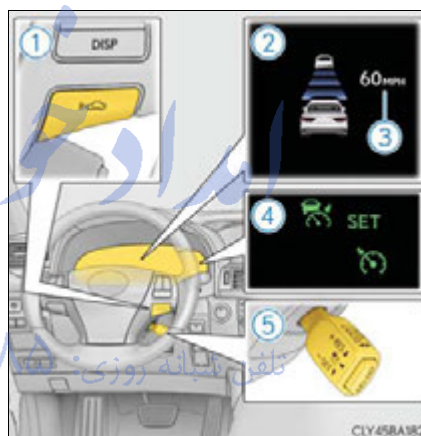

FarmaSOS.com

*: If equipped

Setting the vehicle speed (vehicle-to-vehicle distance control mode)

- 1 Press the "ON•OFF" button to activate the cruise control.

Radar cruise control indicator will come on and a message will be shown on the multi-information display.

Press the button again to deactivate the cruise control.



- 2 Accelerate or decelerate the vehicle to the desired speed, and push the lever down to set the speed.

"SET" indicator will be displayed.

The vehicle speed at the moment the lever is released becomes the set speed.



While the vehicle is in vehicle-to-vehicle distance control mode, if the lever is released when vehicle speed is less than 30 mph (50 km/h) and a vehicle ahead can be detected, the vehicle will start following the vehicle ahead at a set speed of 30 mph (50 km/h).

Adjusting the set speed

To change the set speed, operate the lever until the desired set speed is displayed.

- ① Increases the speed
(Except when the vehicle has been stopped by system control in vehicle-to-vehicle distance control mode)

- ② Decreases the speed
Fine adjustment: Momentarily move the lever in the desired direction.



Large adjustment: Hold the lever in the desired direction.

In the vehicle-to-vehicle distance control mode, the set speed will be increased or decreased as follows:

- When the set speed is shown in "MPH"
 - Fine adjustment: By approximately 1 mph (1.6 km/h) each time the lever is operated
 - Large adjustment: By approximately 5 mph (8 km/h) for each 0.75 seconds the lever is held
- When the set speed is shown in "km/h"
 - Fine adjustment: By approximately 0.6 mph (1 km/h) each time the lever is operated
 - Large adjustment: By approximately 3.1 mph (5 km/h) for each 0.75 seconds the lever is held

In the constant speed control mode (→P. 262), the set speed will be increased or decreased as follows:

Fine adjustment: By approximately 1 mph (1.6 km/h) each time the lever is operated

Large adjustment: The set speed can be increased or decreased continually until the lever is released.

Changing the vehicle-to-vehicle distance

Pressing the button changes the vehicle-to-vehicle distance as follows:

- ① Long
- ② Medium
- ③ Short

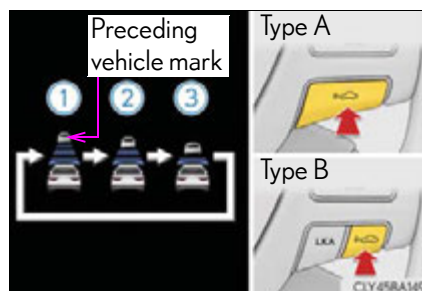

The vehicle-to-vehicle distance is set automatically to long mode when the engine switch is turned to IGNITION ON mode.

If a vehicle is running ahead of you, the preceding vehicle mark will also be displayed.

Vehicle-to-vehicle distance settings

Select a distance from the table below. Note that the distances shown correspond to a vehicle speed of 50 mph (80 km/h). Vehicle-to-vehicle distance increases/decreases in accordance with vehicle speed. When the vehicle is stopped by system control, the vehicle-to-vehicle distance will be about 10 ft. (3 m) to 16 ft. (5 m) regardless of the vehicle-to-vehicle distance setting.

Distance options	Vehicle-to-vehicle distance
Long	Approximately 160 ft. (50 m)
Medium	Approximately 130 ft. (40 m)
Short	Approximately 100 ft. (30 m)

Resuming follow-up cruising when the vehicle has been stopped by system control

After the vehicle ahead of you starts off, push the lever up.

Your vehicle will also resume follow-up cruising if the accelerator pedal is depressed after the vehicle ahead of you starts off.

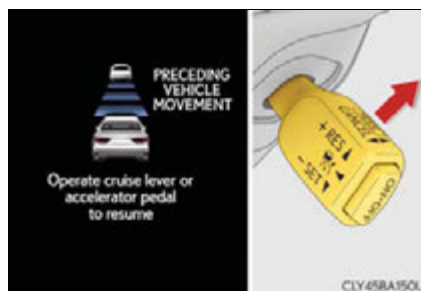

امداد خودرو فارما

تلفن شبانه روزی: ۰۲۱-۸۸۸۶۲۰۸۵

FarmaSOS.com

Canceling and resuming the speed control

- ① Pulling the lever toward you cancels the cruise control.

The setting is also canceled when the brake pedal is depressed while driving.

(When the vehicle has been stopped by system control, applying the brakes does not cancel the setting.)

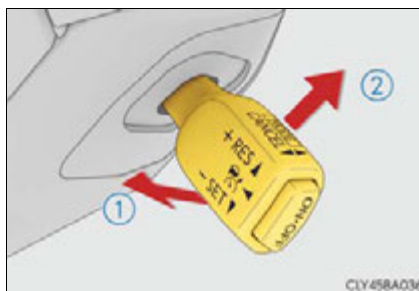

- ② Pushing the lever up resumes the cruise control and returns vehicle speed to the set speed.

However, when a vehicle ahead is not detected in vehicle-to-vehicle distance control mode, cruise control does not resume when the actual vehicle speed is approximately 25 mph (40 km/h) or less. Also, when the vehicle is in constant speed control mode and the actual vehicle speed is approximately 25 mph (40 km/h) or less, cruise control does not resume as the set speed is cleared.

Driving in vehicle-to-vehicle distance control mode

This mode employs a radar sensor to detect the presence of vehicles up to approximately 400 ft. (120 m) ahead, determines the current vehicle-to-vehicle following distance, and operates to maintain a suitable following distance from the vehicle ahead.

Note that vehicle-to-vehicle distance will close in when traveling on long downhill slopes.

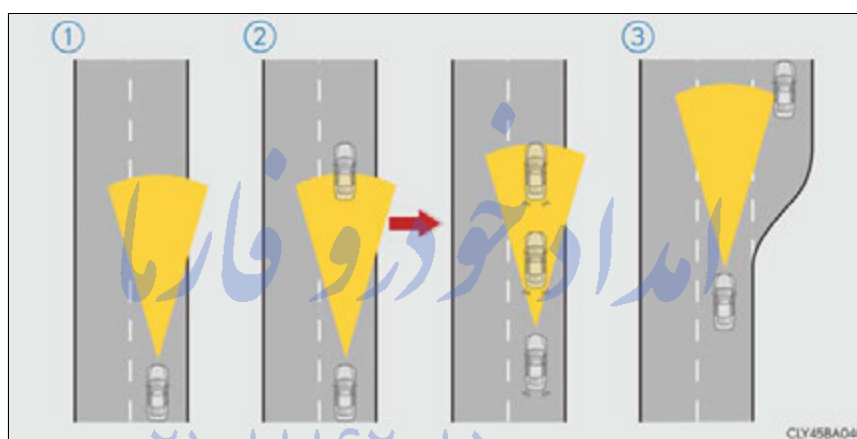

- ① Example of constant speed cruising
When there are no vehicles ahead

The vehicle travels at the speed set by the driver. The desired vehicle-to-vehicle distance can also be set by operating the vehicle-to-vehicle distance control.

- ② Example of deceleration cruising and follow-up cruising
When the vehicle ahead is driving slower than the set speed

When a vehicle is detected running ahead of you, the system automatically decelerates your vehicle. When a greater reduction in vehicle speed is necessary, the system applies the brakes. The system will respond to changes in the speed of the vehicle ahead in order to maintain the vehicle-to-vehicle distance set by the driver. A warning tone warns you when the system cannot decelerate sufficiently to prevent your vehicle from closing in on the vehicle ahead. When the vehicle ahead of you stops, your vehicle will also stop. After the vehicle ahead starts off, pushing the cruise control lever up or depressing the accelerator pedal will resume follow-up cruising.

③ Example of acceleration

When there are no longer any vehicles ahead driving slower than the set speed

The system accelerates until the set speed is reached. The system then returns to constant speed cruising.

Approach warning

When your vehicle is too close to a vehicle ahead, and sufficient automatic deceleration via the cruise control is not possible, the display will flash and the buzzer will sound to alert the driver. An example of this would be if another driver cuts in front of you while you are following a vehicle. Apply the brakes to ensure an appropriate vehicle-to-vehicle distance.

■ Warnings may not occur when

In the following instances, there is a possibility that the warnings will not occur:

- When the speed of the vehicle ahead matches or exceeds your vehicle speed
- When the vehicle ahead is traveling at an extremely slow speed or is stationary
- Immediately after the cruise control speed was set
- At the instant the accelerator is applied

Selecting conventional constant speed control mode

When constant speed control mode is selected, your vehicle will maintain a set speed without controlling the vehicle-to-vehicle distance. Select this mode only when vehicle-to-vehicle distance control mode does not function correctly due to dirt etc.

- ① Press the "ON•OFF" button to activate the cruise control.

Radar cruise control indicator will come on and a message will be shown on the multi-information display.

Press the button again to deactivate the cruise control.

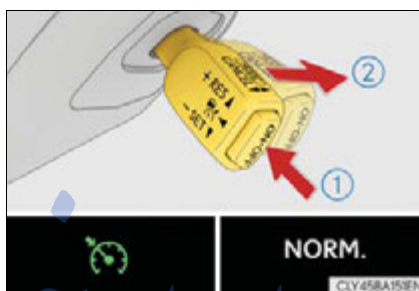

- ② Switch to constant speed control mode.

(Push the lever forward and hold for approximately 1 second.)

Cruise control indicator will come on and a message will be shown on the multi-information display.

When in constant speed control mode, to return to vehicle-to-vehicle distance control mode, push the lever forward again and hold for approximately 1 second.

After the desired speed has been set, it is not possible to return to vehicle-to-vehicle distance control mode.

If the engine switch is turned off and then turned to IGNITION ON mode again, the vehicle will automatically return to vehicle-to-vehicle distance control mode.

Adjusting the speed setting:

→P. 256

Canceling and resuming the speed

setting: →P. 259

■ **Dynamic radar cruise control with full-speed range can be set when**

- The shift lever is in the D or range 4 or higher of S has been selected. (except 2WD models with paddle shift switches)
- The shift lever is in D. (2WD models with paddle shift switches)
- Range 4 or higher of D has been selected by using the paddle shift. (2WD models with paddle shift switches)
- Vehicle speed is above approximately 30 mph (50 km/h).

■ **Accelerating after setting the vehicle speed**

The vehicle can accelerate normally. After acceleration, the set speed resumes. However, during vehicle-to-vehicle distance control mode, the vehicle speed may decrease below the set speed in order to maintain the distance to the vehicle ahead.

4

Driving

تلفن شبانه روزی: ۰۲۱-۸۸۶۲۰۸۵

FarmaSOS.com

■ Automatic cancelation of vehicle-to-vehicle distance control

Vehicle-to-vehicle distance control driving is automatically canceled in the following situations:

- Actual vehicle speed falls below approximately 25 mph (40 km/h) when there are no vehicle ahead.
- The preceding vehicle leaves the lane when your vehicle is following at a speed below 25 mph (40 km/h).
- VSC is activated.
- TRAC is activated for a period of time.
- When the VSC or TRAC system is turned off by pressing the VSC OFF switch.
- The sensor cannot operate correctly because it is covered in some way.
- The windshield wipers are operating at high speed (when the wiper switch is set to the "AUTO" mode or the high speed wiper operation position).
- When snow mode is set.
- The parking brake is operated.
- The vehicle is stopped by system control on a steep incline.
- Pre-collision brake assist is activated.
- The following are detected when the vehicle has been stopped by system control:
 - The driver is not wearing a seat belt.
 - The driver's door is opened.
 - The trunk or hood is opened.
 - The vehicle has been stopped for about 3 minutes.

If vehicle-to-vehicle distance control driving is automatically canceled for any other reason, there may be a malfunction in the system. Contact your Lexus dealer.

FarmaSOS.com

■ Automatic cancelation of constant speed control

The cruise control will stop maintaining the vehicle speed in the following situations:

- Actual vehicle speed is more than approximately 10 mph (16 km/h) below the set vehicle speed.
At this time, the memorized set speed is not retained.
- Actual vehicle speed falls below approximately 25 mph (40 km/h).
- VSC is activated.
- TRAC is activated for a period of time.
- When the VSC or TRAC system is turned off by pressing the VSC OFF switch.

■ When the LKA (Lane-Keeping Assist) will be activated (if equipped)

Using the radar cruise control in vehicle-to-vehicle distance control mode, lane keeping assistance control is activated.

■ Radar sensor and grille cover

Always keep the sensor and grille cover clean to ensure that the vehicle-to-vehicle distance control operates properly. (Some obstructions, such as snow, ice and plastic objects, cannot be detected by the obstruction sensor.)

Dynamic radar cruise control with full-speed range is canceled if an obstruction is detected.

- ① Grille cover
- ② Radar sensor

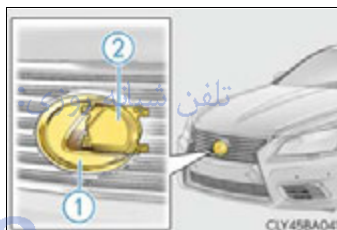

■ Warning messages and buzzers for dynamic radar cruise control with full-speed range

Warning messages and buzzers are used to indicate a system malfunction or to inform the driver of the need for caution while driving. (→P. 514)

■ Certification for the dynamic radar cruise control with full-speed range

- ▶ For vehicles sold in the U.S.A.

FCC ID: HYQDNMWR004

This device complies with part 15 of the FCC Rules. Operation is subject to the following two conditions: (1) This device may not cause harmful interference, and (2) this device must accept any interference received, including interference that may cause undesired operation.

FCC WARNING

Changes or modifications not expressly approved by the party responsible for compliance could void the user's authority to operate the equipment.

Radiofrequency radiation exposure Information:

This equipment complies with FCC radiation exposure limits set forth for an uncontrolled environment.

This equipment should be installed and operated with minimum distance of 20 cm between the radiator (antenna) and your body.

This transmitter must not be co-located or operating in conjunction with any other antenna or transmitter.

- ▶ For vehicles sold in Canada

This device complies with Industry Canada licence-exempt RSS standard(s).

Operation is subject to the following two conditions: (1) this device may not cause interference, and (2) this device must accept any interference, including interference that may cause undesired operation of the device.

FarmaSOS.com

⚠ CAUTION

Dynamic radar cruise control with full-speed range is designed to detect motor vehicles intended for use on public highways, with the exception of motorcycles. It will not detect: stationary objects, pedestrians, motorcycles, bicycles, animals, and similarly sized, or smaller, moving objects. The driver must always be aware of surroundings and in control of the vehicle.

■ **Before using dynamic radar cruise control with full-speed range**

Do not overly rely on vehicle-to-vehicle distance control.

Be aware of the set speed. If automatic deceleration/acceleration is not appropriate, adjust the vehicle speed, as well as the distance between your vehicle and vehicles ahead, by applying the brakes etc.

■ **Cautions regarding the driving assist systems**

Observe the following precautions.

Failure to do so may cause an accident resulting in death or serious injury.

The system, even in vehicle-to-vehicle distance control mode, only assists the driver:

● **To measure following distance**

The dynamic radar cruise control with full-speed range is only intended to help the driver in determining the following distance between the driver's own vehicle and a designated vehicle traveling ahead. It is not a mechanism that allows careless or inattentive driving, and it is not a system that can assist the driver in low-visibility conditions. It is still necessary for driver to pay close attention to the vehicle's surroundings.

● **To judge proper following distance**

The dynamic radar cruise control with full-speed range determines whether the following distance between the driver's own vehicle and a designated vehicle traveling ahead is appropriate or not. It is not capable of making any other type of judgement. Therefore, it is absolutely necessary for the driver to remain vigilant and to determine whether or not there is a possibility of danger in any given situation.

● **To operate the vehicle**

The dynamic radar cruise control with full-speed range cannot prevent or avoid all collisions. Therefore, if there is ever any danger, the driver must take immediate and direct control of the vehicle and act appropriately in order to ensure the safety of all involved.

⚠ CAUTION**■ To avoid inadvertent dynamic radar cruise control with full-speed range activation**

Switch the cruise control off using the "ON•OFF" button when not in use.

■ Situations unsuitable for dynamic radar cruise control with full-speed range

Do not use dynamic radar cruise control with full-speed range in any of the following situations.

Doing so may result in inappropriate speed control and could cause an accident resulting in death or serious injury.

- In heavy traffic
- On city streets
- On roads with sharp turns
- On winding roads
- On slippery roads, such as those covered with rain, ice or snow
- On steep downhills, or where there are sudden changes between sharp up and down gradients
Vehicle speed may exceed the set speed when driving down a steep hill.
- At entrances to expressways
- When weather conditions are bad enough that they may prevent the sensors from functioning correctly (fog, snow, sandstorm, heavy rain, etc.)
- When an approach warning buzzer is heard often
- In areas where the driver is likely to encounter pedestrians, motorcyclists, bicyclists, animals, stationary objects or other people/objects not detectable by the system. (→P. 267)

⚠ CAUTION**■ When the sensor may not be correctly detecting a vehicle ahead**

Apply the brakes as necessary when any of the following types of vehicles are in front of you.

As the sensor may not be able to correctly detect these types of vehicles, the approach warning (→P. 261) will not be activated, and a fatal or serious accident may result.

- Vehicles traveling at low speeds
- Vehicles that are stationary
- Motorcycles traveling in the same lane
- Vehicles with small rear ends (trailers with no load on board etc.)
- Vehicles that cut in suddenly

Details about other people/objects the system will not detect:

→P. 267

■ Conditions under which the vehicle-to-vehicle distance control may not function correctly

Apply the brakes as necessary in the following conditions as the radar sensor may not be able to correctly detect vehicles ahead, and a fatal or serious accident may result:

- When water or snow splashed by the surrounding vehicles hinders the functioning of the sensor
- When your vehicle is tilted upwards (due to a heavy load in the trunk etc.)
- When the road curves or when the lanes are narrow
- When steering wheel operation or your position in the lane is unstable
- When the vehicle ahead decelerates suddenly as the system is not able to respond to sudden braking.

Details about limitations:

→P. 267

Details about unsuitable conditions:

→P. 268

⚠ CAUTION**■ Handling the radar sensor**

Observe the following to ensure the cruise control system can function effectively. Otherwise, the system may not function correctly and could result in an accident.

- Keep the sensor and grille cover clean at all times.
Clean the sensor and grille cover with a soft cloth so you do not mark or damage them.
- Do not subject the sensor or surrounding area to a strong impact.
If the sensor moves even slightly off position, the system may malfunction. If the sensor or surrounding area is subject to a strong impact, always have the area inspected and adjusted by your Lexus dealer.
- Do not disassemble the sensor.
- Do not attach accessories or stickers to the sensor, grille cover or surrounding area.
- Do not modify or paint the sensor and grille cover.
- If the radar sensor needs to be replaced, contact your Lexus dealer.

تلفن شبانه روزی: ۰۲۱-۸۸۸۶۲۰۸۵

FarmaSOS.com

LKA (Lane-Keeping Assist)*

Summary of functions

While driving on a freeway or motor highway that has lane markers and no sharp curves, the system recognizes the lanes using a camera located above the inside rear view mirror as a sensor to assist the driver with staying in the lane. The LKA system has two functions.

Camera sensor



4

Driving

تلفن شبانه روزی: ۰۲۱-۸۸۸۶۲۰۸۵

FarmaSOS.com

*: If equipped

Functions included in the LKA

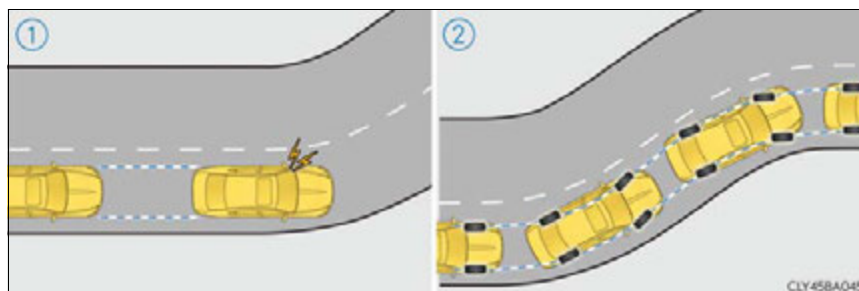

① Lane departure warning function

If the system judges that the vehicle may deviate from its lane, it alerts the driver using rapid beeping, indications on the multi-information display, and a sensory warning* given via the steering wheel.

*: A slight steering torque is applied for a short period of time in the direction of the center of the lane.

② Lane keeping assist function

- This function will be active when the vehicle-to-vehicle distance control mode of the dynamic radar cruise control with full-speed range (→P. 254) is set with vehicle speed above approximately 45 mph (72 km/h) and while the lane departure warning function is active.
- When the lane keeping assist function is active, a slight steering torque will be applied, to help the driver maintain the vehicle inside the lane.

The lane keeping assist function will be temporarily canceled if the steering wheel is not operated, or if you continue driving with your hands lightly touching the steering wheel. (→P. 276)

Turning the LKA system on

Press the LKA switch to activate the system.

LKA indicator will come on.

Press the switch again to turn the LKA system off.

The LKA system will revert to off each time the engine switch is turned to IGNITION ON mode.



امداد خودرو فارما

تلفن شبانه روزی: ۰۲۱-۸۸۸۶۲۰۸۵

FarmaSOS.com

Operating conditions for each function

■ Lane departure warning function

- When the vehicle speed is approximately 30 mph (48 km/h) or more
- When the lane width is more than approximately 9.8 ft. (3.0 m)
- When driving on a straight road or through a curve with a radius of more than approximately 394 ft. (120 m)

■ Lane keeping assist function

- When the vehicle speed is between approximately 45 and 112 mph (72 and 180 km/h)
- When the vehicle-to-vehicle distance mode of the dynamic radar cruise control with full-speed range is on, and the set vehicle speed is approximately 45 mph (72 km/h) or more (the function will not operate when the dynamic radar cruise control with full-speed range is in set speed mode)
- When the lane width is between approximately 9.8 and 13.1 ft. (3.0 and 4.0 m)
- When driving on a straight road or through a curve with a radius of more than approximately 656 ft. (200 m)

FarmaSOS.com

Indication on the multi-information display

When the LKA system is on, the lane line display and steering wheel display are shown.

- ① Lane keeping assist function operation indication

Steering wheel displayed:

Indicates that the function is currently operating. (If the lane departure warning operates at this time, the steering wheel flashes orange.)

Steering wheel not displayed:

Indicates that the function is not currently operating. (When the lane keeping assist function is canceled, the buzzer will beep twice.)

- ② Dynamic radar cruise control with full-speed range display

- ③ Lane departure warning function indication (when the inside of the white line is white):

The function has recognized lane markers. (If the lane departure warning operates at this time, the lines flash orange.)

- ④ Lane departure warning function indication (when the inside of the white line is black):

A lane marker is not recognized by the system, or the LKA system functions are temporarily canceled.

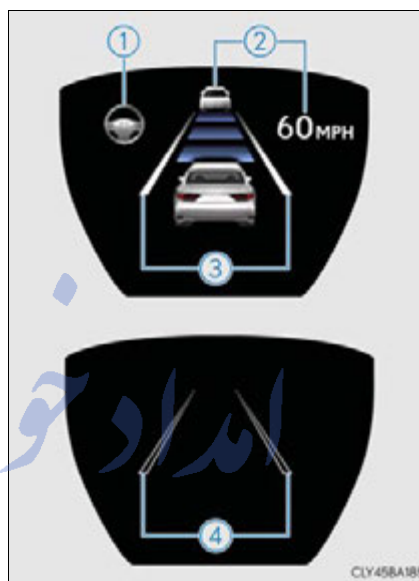

■ **Temporary cancelation of the LKA system functions**

If any of the following occurs, the LKA system functions will be temporarily canceled. The functions will resume after the necessary operating conditions have returned.

- The steering wheel is turned as far as necessary to cause the vehicle to change lanes.
- When the system detects no-handed driving. (The lane keeping assist function will be temporarily canceled, but the lane departure warning function will continue.)
- The turn signal lever is operated.
- The vehicle speed deviates from the operating range of the LKA system functions. (The buzzer will beep twice when the lane keeping assist function is being canceled.)
- When the lane lines cannot be recognized while driving.
- When the wiper switch is in the high speed position or is set to "AUTO" mode with the wipers operating at high speed. (The lane keeping assist function will be temporarily canceled, but the lane departure warning function will continue.)
- If the vehicle crosses a line for approximately half a minute or more. (The lane keeping assist function will be temporarily canceled, but the lane departure warning function will continue.)
- When the lane departure warning function is activated.
The lane departure warning function will not operate again for several seconds after it has been activated, even if the vehicle leaves the lane again.

■ **The lane departure warning**

It may be difficult to feel the sensory warning depending on the road conditions.

■ **No-handed driving warning**

If the steering wheel is not operated for approximately 15 seconds on a straight road or approximately 5 seconds on a curve, the buzzer will beep twice, indicators on the multi-information display will flash, and the lane keeping assist function will be temporarily canceled. If you drive the vehicle with your hands lightly touching the steering wheel, this may also be detected as no-handed driving.

■ After the vehicle has been parked in the sun

The LKA system functions may not be available and a warning message (→P. 514) will be displayed for a while after driving has started. In such cases, turn the LKA system off and turn it on again after normal temperature returns. When the temperature in the cabin decreases and the temperature around the camera sensor (→P. 271) becomes suitable for its operation, the functions will begin to operate.

■ If there are lane markers on only one side of the vehicle

The lane keeping assist function will not operate. Also, the lane departure warning will not operate for the side on which lane markers could not be recognized.

■ Conditions in which the function may not operate correctly

In the following conditions, the LKA system functions may not operate, or it may not be possible to ensure adequate performance. Also, the camera sensor may be unable to recognize lane lines causing the lane departure warning function to operate incorrectly, or the lane keeping assist function may not operate properly. However, this does not indicate a malfunction.

- When driving through an area with no lane markers, such as a tollbooth, a crossing or before a ticket checkpoint
- When driving on a sharp curve
- When lanes are extremely narrow or extremely wide
- When the vehicle leans to one side an unusual amount due to a heavy load or improper tire inflation pressure
- When the following distance between your vehicle and the vehicle ahead is extremely short
- When the lane markers are yellow (These may be more difficult for the system to recognize compared to white markers.)
- When the lane markers are broken, "Botts' dots", "Raised pavement marker" or stones
- When lane markers are obscured or partially obscured by sand, dirt, etc.
- When there are shadows on the road running parallel with lane markers, or if a shadow covers the lane markers
- When driving on a particularly bright road surface, such as concrete
- When driving on a road surface that is bright due to reflected light
- When driving in a location where the light level changes rapidly, such as the entrance to or exit from a tunnel
- When sunlight or the headlights of oncoming vehicles are shining directly into the camera lens
- When driving on roads that are branching or merging

- When driving on a road surface that is wet due to rain, previous rainfall, standing water, etc.
- When the vehicle experiences strong up-and-down motion such as when driving on an extremely rough road or on a seam in the pavement
- When headlight brightness at nighttime is reduced due to dirt on the lenses, or when the headlights are misaligned
- When driving with a strong crosswind
- When driving on winding roads or roads that are uneven
- When driving on rough or unpaved roads

■ **When changing the tires**

Depending on the tires used, such as snow tires, etc., sufficient performance may not be maintainable.

■ **Warning messages for LKA**

Warning messages are used to indicate a system malfunction or to inform the driver of the need for caution while driving. (→P. 514)

 **CAUTION**

■ **Before using the LKA system**

Do not rely solely on the LKA system. The LKA system does not drive the vehicle automatically, nor does it reduce the amount of care you need to take. As such, the driver must always assume full responsibility for understanding his/her surroundings, for operating the steering wheel to correct the driving line, and for driving safely.

Inappropriate or negligent driving could lead to an accident.

■ **To avoid operating the LKA by mistake**

Switch the LKA off using the LKA switch when not in use.

⚠ CAUTION**■ Situations unsuitable for LKA**

Do not use LKA in any of the following situations.

Otherwise, the system may not function correctly and could result in an accident.

- When driving with tire chains or similar equipment
- When the tires have been excessively worn, or when the tire inflation pressure is low
- When there are objects or structures along the roadside that might be misinterpreted as lane markers (such as guardrails, curb, reflector posts, etc.)
- When driving on snowy roads
- When pavement lane markers are difficult to see due to rain, snow, fog, sand, dirt, etc.
- When there are visible lines on the pavement from road repairs, or if the remains of old lane markers are still visible on the road
- When driving on slippery roads, such as those covered with rain, ice or snow
- When driving in a lane other than the driving or passing lanes on a freeway or highway
- When driving on a road with lane closures due to maintenance, or when driving in a temporary lane

4

Driving

⚠ NOTICE**■ To prevent damage to or incorrect operation of the LKA system**

- Do not modify the headlights or attach stickers to the surface of the lights.
- Do not modify the suspension.
If any suspension parts need to be replaced, contact your Lexus dealer.
- Do not install or place anything on the hood or the grille. Also, do not install a grille guard (bull bars, kangaroo bar etc.).
- Do not modify the sun visor.
If the sun visor needs to be replaced, contact your Lexus dealer.
- If the windshield needs to be replaced, contact your Lexus dealer.

 NOTICE

■ Camera sensor (→P. 271)

Observe the following to ensure that the LKA system functions correctly.

- Keep the windshield clean at all times.
Performance could be affected if the windshield is dirty, or if raindrops, condensation or ice are adhering to the windshield.
 - Do not attach a sticker or other items to the windshield near the camera sensor.
 - Do not install or place anything near the camera.
-
- Do not attach window tinting to the windshield.
 - Do not install an antenna in front of the camera lens.
 - If the windshield is fogged up, use the windshield defogger to remove fog from the windshield.
When it is cold, using the heater with air blowing to the feet may allow the upper part of the windshield to fog up. This will have a negative effect on the images.
 - Do not place anything on the dashboard.
The camera sensor may recognize the image reflected on the windshield as lane markers by mistake.
 - Do not scratch the camera lens, or let it get dirty.
When cleaning the inside of the windshield, be careful not to get any glass cleaner etc. on the lens. Also, do not touch the lens.
For lens repair, contact your Lexus dealer.
 - Do not change the installation position or direction of the camera sensor or remove it. The direction of the camera sensor is precisely adjusted.
 - Do not subject the camera sensor to strong impact or force, and do not disassemble the camera sensor.

Driving mode select switch

The driving modes can be selected to suit driving condition.

- ▶ Vehicles without electronically modulated air suspension

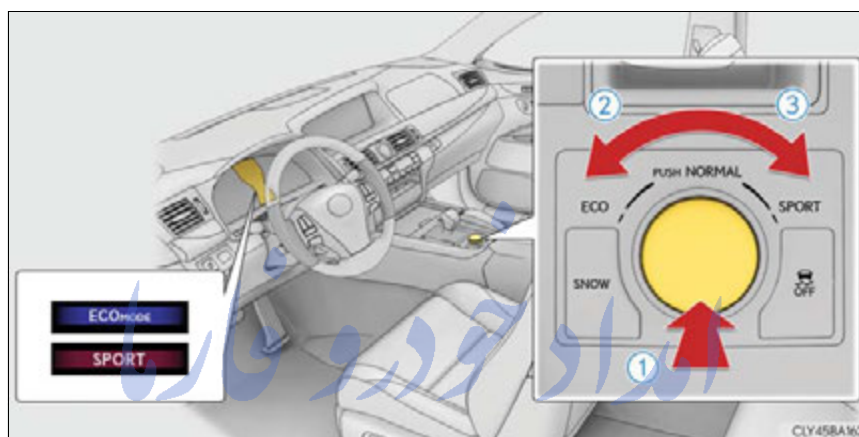

① Normal mode

For normal driving.

Press the switch to change the driving mode to normal mode when not in normal mode.

② Eco drive mode

Use Eco drive mode to help achieve low fuel consumption during trips that involve frequent accelerating.

When not in Eco drive mode and the driving mode select switch is turned to the left, the "ECO MODE" indicator comes on and Eco Driving Indicator Zone Display and average fuel consumption is shown on the multi-information display. (→P. 96)

③ Sport mode

Assists acceleration response by controlling the transmission and steering. Suitable for when precise handling is desirable, for example when driving on mountain roads.

When not in Sport mode and the driving mode select switch is turned to the right, the "SPORT" indicator comes on in the multi-information display.

▶ Vehicles with electronically modulated air suspension

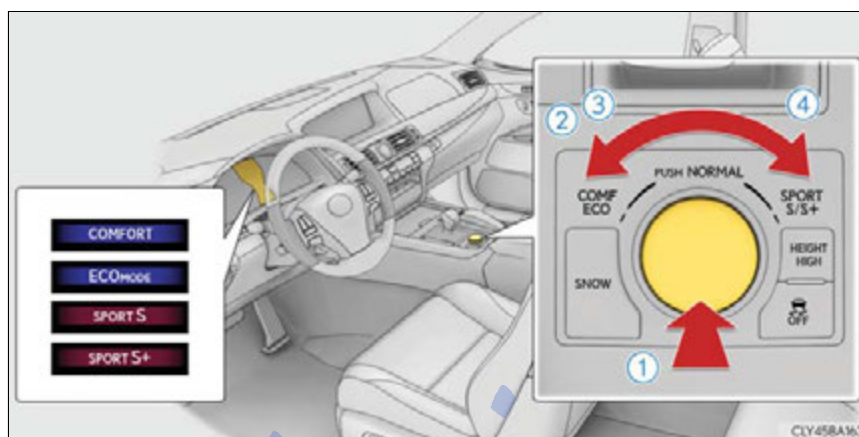

① Normal mode

For normal driving.

Press the switch to change the driving mode to normal mode when not in normal mode.

② Comfort mode

By controlling the suspension, riding comfort is further enhanced. Suitable for city driving.

When not in comfort mode and the driving mode select switch is turned to the left, the "COMFORT" indicator comes on in the multi-information display.

③ Eco drive mode

Use Eco drive mode to help achieve low fuel consumption during trips that involve frequent accelerating.

When in comfort mode and the driving mode select switch is turned to the left, the "ECO MODE" indicator comes on and Eco Driving Indicator Zone Display and average fuel consumption is shown on the multi-information display.

(→P. 96)

④ Sport mode

- SPORT S mode

Assists acceleration response by controlling the transmission and the engine. Suitable for when powerful acceleration is desirable.

When not in SPORT S mode and the driving mode select switch is turned to the right, the "SPORT S" indicator comes on in the multi-information display.

- SPORT S+ mode

Helps to ensure steering performance and driving stability by simultaneously controlling the steering and suspension in addition to the transmission. Suitable for sporty driving.

When in SPORT S mode and the driving mode select switch is turned to the right, the "SPORT S+" indicator comes on in the multi-information display.

■ Operation of the air conditioning system in Eco drive mode

Eco drive mode controls the heating/cooling operations and fan speed of the air conditioning system to enhance fuel efficiency (→P. 334). To improve air conditioning performance, adjust the fan speed or turn off Eco drive mode.

■ Sport mode automatic deactivation

Sport mode is automatically deactivated if the engine switch is turned off after driving in sport mode.

■ Driving mode pop-up display

When the driving mode is changed, the selected driving mode will be temporarily displayed on the side display. (→P. 332)

Electronically modulated air suspension*

By independently controlling the damping force of the shock absorbers for each of the 4 wheels according to the road and driving conditions and the selected driving mode, this system achieves ride comfort with superior steering stability, and ensures good vehicle posture. In addition, vehicle height can be selected according to road and driving conditions.

The vehicle height is maintained at the selected level regardless of the number of occupants and luggage weight.

Turns high mode on/off.

When on, the "HEIGHT HIGH" indicator will come on.

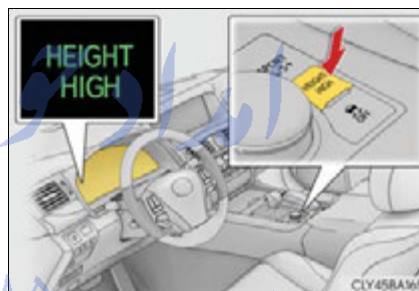

■ Operating sound of the air suspension compressor

When the vehicle height is lowered, such as when entering or loading the vehicle, or high mode is selected, the compressor may operate and a whirring sound may be heard. This does not indicate a malfunction.

*: If equipped

⚠ CAUTION

■ Be sure to stop the engine in the following situations in order to stop operation of the electronically modulated air suspension:

- The vehicle is parked on a curb.
- Any of the wheels is stuck in a ditch.
- It is necessary to jack up the vehicle.
- It is necessary to tow the vehicle with part of it lifted.

If the engine switch remains in IGNITION ON mode, the vehicle height may change, and you may catch part of your body in the vehicle, resulting in accidental damage.

امداد خودرو فارما

تلفن شبانه روزی: ۰۲۱-۸۸۸۶۲۰۸۵

FarmaSOS.com

Driving assist systems

To help enhance driving safety and performance, the following systems operate automatically in response to various driving situations. Be aware, however, that these systems are supplementary and should not be relied upon too heavily when operating the vehicle.

◆ ABS (Anti-lock Brake System)

Helps to prevent wheel lock when the brakes are applied suddenly, or if the brakes are applied while driving on a slippery road surface

◆ Brake assist

Generates an increased level of braking force after the brake pedal is depressed when the system detects a panic stop situation

◆ VSC (Vehicle Stability Control)

Helps the driver to control skidding when swerving suddenly or turning on slippery road surfaces

◆ TRAC (Traction Control)

Helps to maintain drive power and prevent the drive wheels from spinning when starting the vehicle or accelerating on slippery roads

◆ Hill-start assist control

Helps to prevent the vehicle from rolling backward when starting on an incline or slippery slope

◆ VGRS (Variable Gear Ratio Steering) (if equipped)

Adjusts the wheel turning angle in accordance with the vehicle speed and steering wheel movement

◆ EPS (Electric Power Steering)

Employs an electric motor to reduce the amount of effort needed to turn the steering wheel

◆ VDIM (Vehicle Dynamics Integrated Management)

Provides integrated control of the ABS, brake assist, TRAC, VSC, hill-start assist control, EPS and VGRS (if equipped) systems

Helps to maintain vehicle stability when swerving on slippery road surfaces by controlling the brakes, engine output, steering assist, and if equipped with VGRS, steering ratio

◆ PCS (Pre-Collision System) (if equipped)

→P. 293

◆ BSM (Blind Spot Monitor) (if equipped)

→P. 306

When the TRAC/VSC/ABS/hill-start assist control systems are operating

The slip indicator light will flash while the TRAC/VSC/ABS/hill-start assist control systems are operating.

The stop lights and high mounted stoplight turn on when the hill-start assist control system is operating.



Disabling the TRAC/VSC systems

If the vehicle gets stuck in fresh snow or mud, the TRAC and VSC systems may reduce power from the engine to the wheels. Pressing VSC OFF switch to turn the system off may make it easier for you to rock the vehicle in order to free it.

■ Turning off the TRAC system only

To turn the TRAC system off, quickly press and release the switch.

The "TRAC OFF" will be shown on the multi-information display. Press the switch again to turn the system back on.

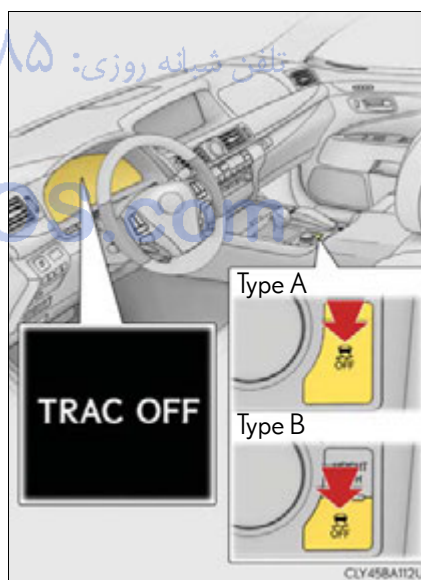

■ Turning off both TRAC and VSC systems

To turn the TRAC and VSC systems off, press and hold the switch for more than 3 seconds while the vehicle is stopped.

The VSC OFF indicator light will come on and the "TRAC OFF" will be shown on the multi-information display.*

Press the switch again to turn the systems back on.

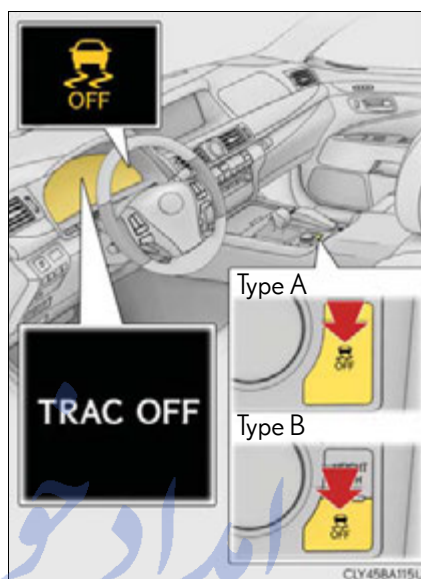

*: On vehicles with pre-collision system, pre-collision alert braking, pre-collision brake assist and pre-collision braking will also be disabled. The pre-collision system warning light will come on and the "Pre-collision brakes are disabled because VSC is OFF" will be shown on the multi-information display. (→P. 293)

■ **When the message is displayed on the multi-information display showing that TRAC has been disabled even if the VSC OFF switch has not been pressed**

TRAC and hill-start assist control cannot be operated. Contact your Lexus dealer.

■ **Hill-start assist control is operational when**

- The system has detected that the vehicle is moving backward.
- Except 2WD models with paddle shift switches: The shift lever is in the D or S position.
- 2WD models with paddle shift switches: The shift lever is in the D or M position.
- The brake pedal is not depressed.

■ **VGRS is disabled when**

VGRS may stop operating in the following situations.

In this event, the steering wheel may move from its straight forward position, but it will return when the system restarts.

- When the steering wheel is operated for an extended period of time while the vehicle is stopped or is moving very slowly
- When the steering wheel has been held fully to the left or right
- When the battery is low or the voltage temporarily drops

The center position of the steering wheel may change when VGRS is disabled. However, the position will return to normal after VGRS is reactivated.

■ **Sounds and vibrations caused by the ABS, brake assist, TRAC, VSC, hill-start assist control and VGRS systems**

- A sound may be heard from the engine compartment when the brake pedal is depressed repeatedly, when the engine is started or just after the vehicle begins to move. This sound does not indicate that a malfunction has occurred in any of these systems.
- Any of the following conditions may occur when the above systems are operating. None of these indicates that a malfunction has occurred.
 - Vibrations may be felt through the vehicle body and steering.
 - A motor sound may be heard after the vehicle comes to a stop.
- The steering wheel may be moved slightly or a sound may be heard when the engine is started or stopped. None of these indicate that a malfunction has occurred.

■ EPS operation sound

When the steering wheel is operated, a motor sound (whirring sound) may be heard. This does not indicate a malfunction.

■ Reactivation of the TRAC/VSC systems

Even after the TRAC/VSC systems have been turned off, turning the engine off and then on again will automatically reactivate the TRAC/VSC systems.

■ Reactivation of the TRAC system linked to vehicle speed

When only the TRAC system is turned off, the TRAC system will turn on when vehicle speed increases. However, when both TRAC/VSC systems are turned off, the systems will not turn on even when vehicle speed increases.

■ Reduced effectiveness of the EPS system

The effectiveness of the EPS system is reduced to prevent the system from overheating when there is frequent steering input over an extended period of time. The steering wheel may feel heavy as a result.* Should this occur, refrain from excessive steering input or stop the vehicle and turn the engine off. The EPS system should return to normal within 10 minutes.

*: If the LKA (Lane-Keeping Assist) system cannot operate in this case, a warning message will be shown on the multi-information display.

4

Driving

⚠ CAUTION

■ The ABS does not operate effectively when

- The limits of tire gripping performance have been exceeded (such as excessively worn tires on a snow covered road).
- The vehicle hydroplanes while driving at high speed on wet or slick roads.

■ Stopping distance when the ABS is operating may exceed that of normal conditions

The ABS is not designed to shorten the vehicle's stopping distance. Always maintain a safe distance from the vehicle in front of you, especially in the following situations:

- When driving on dirt, gravel or snow-covered roads
- When driving with tire chains
- When driving over bumps in the road
- When driving over roads with potholes or uneven surfaces

⚠ CAUTION**■ TRAC may not operate effectively when**

Directional control and power may not be achievable while driving on slippery road surfaces, even if the TRAC system is operating.
Do not drive the vehicle in conditions where stability and power may be lost.

■ Hill- start assist control does not operate effectively when

Do not overly rely on the hill-start assist control. The hill-start assist control may not operate effectively on steep inclines and roads covered with ice.

■ When the VSC is activated

The slip indicator light flashes. Always drive carefully. Reckless driving may cause an accident. Exercise particular care when the indicator light flashes.

■ When the TRAC/VSC systems are turned off

Be especially careful and drive at a speed appropriate to the road conditions. As these are the systems to help ensure vehicle stability and driving force, do not turn the TRAC/VSC systems off unless necessary.

■ Replacing tires

Make sure that all tires are of the specified size, brand, tread pattern and total load capacity. In addition, make sure that the tires are inflated to the recommended tire inflation pressure level.

The ABS, TRAC and VSC systems will not function correctly if different tires are installed on the vehicle.

Contact your Lexus dealer for further information when replacing tires or wheels.

■ Handling of tires and the suspension

Using tires with any kind of problem or modifying the suspension will affect the driving assist systems, and may cause a system to malfunction.

PCS (Pre-Collision System)*

When the sensor detects that a frontal collision is highly likely or even unavoidable, safety systems such as the brakes and seat belts are automatically engaged to help avoid a collision or to lessen impact as well as vehicle damage.

◆ Pre-collision warning

When a high possibility of a frontal collision is detected, the pre-collision system warning light flashes, a buzzer sounds and a message is shown on the multi-information display to urge the driver to take evasive action.

Pre-collision warning can be disabled using the pre-collision braking off switch.

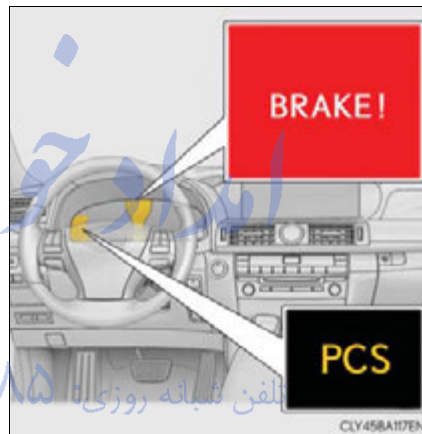

4

Driving

◆ Pre-collision seat belts (front seat only)

If the pre-collision sensor detects that a collision is unavoidable, the pre-collision system will retract the seat belt before the collision occurs. The same will happen if the driver makes an emergency braking or loses control of the vehicle. (→P. 40)

◆ Pre-collision brake assist

When there is a high possibility of a frontal collision, the system applies greater braking force in relation to how strongly the brake pedal is depressed.

*: If equipped

◆ **Pre-collision braking**

When there is a high possibility of a frontal collision, the system warns the driver using a warning light, warning display and buzzer. If the system determines that a collision is unavoidable, the brakes are automatically applied to help avoid a collision or to reduce the collision speed.

When the vehicle is being stopped by pre-collision braking, the brake will be engaged for a maximum of 2 seconds and then released automatically. This pre-collision braking can be canceled by depressing the accelerator pedal or brake pedal.

Pre-collision braking can be disabled using the pre-collision braking off switch.

◆ **Suspension control**

When there is a high possibility of a frontal collision, the operation of suspension control helps prevent the front of the vehicle from dropping when the brakes are applied suddenly.

◆ **Steering gear control (VGRS) (vehicles with camera sensors)**

When the system determines that a collision is unavoidable, the steering gear ratio is changed to help improve the response to steering input.

◆ **Driver monitor system (if equipped)**

When the system determines that there is a possibility of a collision, and either the driver is not facing forward or the driver's eyes are closed, pre-collision warnings are given in advance to warn the driver. If the system determines that the conditions to operate pre-collision alert braking have been met even when the possibility of a collision increases further, pre-collision alert braking will operate.

Pre-collision alert braking can be disabled using the pre-collision braking off switch.

Disabling pre-collision braking

Pre-collision warning, pre-collision braking and pre-collision alert braking (vehicles with driver monitor system) can be switched between enabled and disabled by pressing the pre-collision braking off switch.

① Enabled

② Disabled

The pre-collision system warning light comes on when the system is disabled.

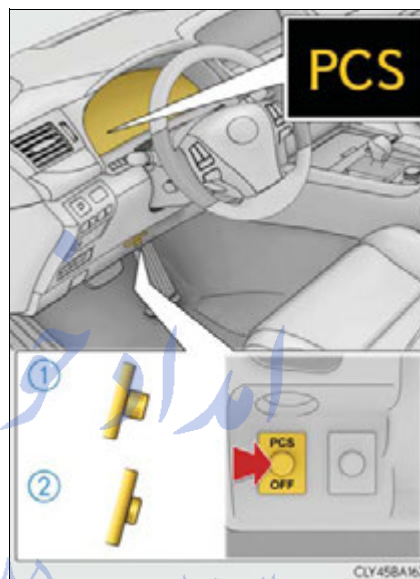

4

Driving

Radar sensor

The radar sensor detects vehicles or other obstacles on or near the road ahead and determines whether a collision is imminent based on the position, speed, and heading of the obstacles.

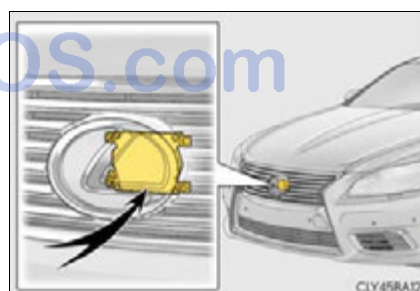

Camera sensors (if equipped)

The camera sensors detect pedestrians and other three-dimensional objects on or near the road ahead together with the radar sensor while the vehicle is moving.

When the headlights are on, near-infrared rays are projected to ensure proper detection performance in the night time.

- ① Camera sensors
- ② Near-infrared ray transmitters



Driver monitor sensor (vehicles with driver monitor system)

The driver monitor sensor detects the direction the driver is facing and whether the driver's eyes are open or closed.

The system determines whether the driver is facing forward and whether or not the driver's eyes are closed.

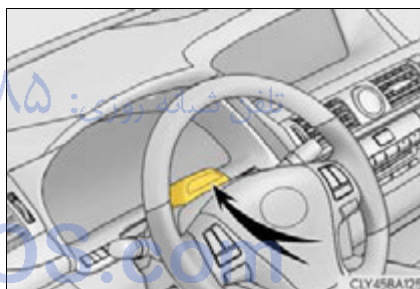

■ The pre-collision system is operational when

- Pre-collision warning:
 - ▶ Vehicles without camera sensors
 - The pre-collision braking off switch is not pressed.
 - Vehicle speed is greater than about 10 mph (15 km/h).
 - The speed at which your vehicle is approaching the obstacle or the vehicle running ahead of you is greater than about 10 mph (15 km/h).
 - ▶ Vehicles with camera sensors
 - The pre-collision braking off switch is not pressed.
 - Vehicle speed is greater than about 4 mph (5 km/h).
 - The speed at which your vehicle is approaching the obstacle or the vehicle running ahead of you is greater than about 4 mph (5 km/h).
- Pre-collision seat belts (operating conditions A):
 - Vehicle speed is greater than about 19 mph (30 km/h).
 - The system detects sudden braking or skidding.
 - The front occupants are wearing a seat belt.
- Pre-collision seat belts (operating conditions B):
 - Vehicle speed is greater than about 4 mph (5 km/h).
 - The speed at which your vehicle is approaching the obstacle or the vehicle running ahead of you is greater than about 19 mph (30 km/h).
 - The front occupants are wearing a seat belt.
- Pre-collision brake assist:
 - The VSC OFF switch is not pressed.
 - Vehicle speed is greater than about 19 mph (30 km/h).
 - The speed at which your vehicle is approaching the obstacle or the vehicle running ahead of you is greater than about 19 mph (30 km/h).
 - The brake pedal is depressed.
- Pre-collision braking:
 - ▶ Vehicles without camera sensors
 - The pre-collision braking off switch is not pressed.
 - The VSC OFF switch is not pressed.
 - Vehicle speed is greater than about 10 mph (15 km/h).
 - The speed at which your vehicle is approaching the obstacle or the vehicle running ahead of you is greater than about 10 mph (15 km/h).
 - ▶ Vehicles with camera sensors
 - The pre-collision braking off switch is not pressed.
 - The VSC OFF switch is not pressed.
 - Vehicle speed is greater than about 4 mph (5 km/h).
 - The speed at which your vehicle is approaching the obstacle or the vehicle running ahead of you is greater than about 4 mph (5 km/h).

- Suspension control:
 - Vehicle speed is greater than about 4 mph (5 km/h).
 - The speed at which your vehicle is approaching the obstacle or the vehicle running ahead of you is greater than about 19 mph (30 km/h).
- Steering gear control (VGRS) (vehicles with camera sensors):
 - Vehicle speed is greater than about 19 mph (30 km/h).
 - The speed at which your vehicle is approaching the obstacle or the vehicle running ahead of you is greater than about 19 mph (30 km/h).
- Pre-collision alert braking (vehicles with driver monitor system):
 - The pre-collision braking off switch is not pressed.
 - The VSC OFF switch is not pressed.
 - The system determines that the driver is not facing forward, or that the driver's eyes are closed.
 - Vehicle speed is greater than about 25 mph (40 km/h).
 - The speed at which your vehicle is approaching the vehicle running ahead of you is greater than about 25 mph (40 km/h).
 - The steering is not being turned.

امداد خودرو فارما
تلفن شبانه روزی: ۰۲۱-۸۸۸۶۲۰۸۵

FarmaSOS.com

■ Conditions that may trigger the system even if there is no danger of a collision

In any of the following situations where the frontal area of the radar sensor is interrupted, the radar sensor may detect possibility of a frontal collision and the system may be activated.

- When passing by an oncoming vehicle in a curve or a turn to the right or the left.
- When rapidly approaching an obstacle ahead (e.g. preceding vehicle, toll gate barrier, etc.)
- When there is a structural object (billboard, low ceiling, fluorescent light, etc.) above the uphill road ahead
- When driving on a narrow road or through under a low overhead structure (bridge, tunnel, fly-under, etc.)
- When driving on an uneven road surface
- When there is a metal object, bump, or protrusion on the road surface
- When vehicle front part is raised or lowered depending on loading conditions
- When the direction of radar sensor is misaligned by strong impact applied on an area around the radar sensor, etc.
- When there is an obstacle (guard rail, etc.) by the roadside at the entrance to a curve
- When the front of your vehicle is pointing upwards (caused by putting a heavy load in the trunk etc.)
- When driving through an area filled with steam or smoke

When the system is activated in the situations described above, there is also a possibility that the seat belts will retract quickly and the brakes may be applied with a force greater than normal. When the seat belt is locked in the retracted position, stop the vehicle in a safe place, release the seat belt and refasten it.

■ Obstacles not detected

The radar sensor cannot detect plastic obstacles such as traffic cones. There may also be occasions when the sensor cannot detect pedestrians, animals, bicycles, motorcycles, trees, or snowdrifts.

■ A camera sensor cannot detect obstacles in the following situations:

- A camera sensor is directly receiving intense light, such as sunlight.
- Visibility is poor because of bad weather or other reasons.
- The sensor temperature is extremely high.
- The headlights are not turned on in darkness such as at night or in a tunnel.

■ **Situations in which the pre-collision system does not function properly**

The system may not function effectively in situations such as the following:

- On roads with sharp bends or uneven surfaces
- If a vehicle suddenly moves in front of your vehicle, such as at an intersection
- If a vehicle suddenly cuts in front of your vehicle, such as when overtaking
- In inclement weather such as heavy rain, fog, snow or sand storms
- If the vehicle is skidding when VSC is not operating
- When an extreme change in vehicle height occurs
- When only part of your vehicle's front end collides with, or contacts, a vehicle or object in a frontal collision
- When the radar sensor moves off position due to its surrounding area being subjected to a strong impact
- If an obstacle in front of the vehicle is small
- When the system judges that the driver performed a collision avoidance operation via the accelerator pedal, brake pedal, or steering wheel

■ **Automatic cancelation of the pre-collision system**

When a malfunction occurs due to sensor contamination, etc. that results in the sensors being unable to detect obstacles, the pre-collision system will be automatically disabled. In this case, the system will not activate even if there is a collision possibility.

■ **When there is a malfunction in the system**

The pre-collision system warning light will flash and warning messages will be displayed. (→P. 506, 514)

FarmaSOS.com

■ Certification for the pre-collision system

- ▶ For vehicles sold in the U.S.A.

FCC ID: HYQDNMWR004

This device complies with part 15 of the FCC Rules. Operation is subject to the following two conditions: (1) This device may not cause harmful interference, and (2) this device must accept any interference received, including interference that may cause undesired operation.

FCC WARNING

Changes or modifications not expressly approved by the party responsible for compliance could void the user's authority to operate the equipment.

Radiofrequency radiation exposure Information:

This equipment complies with FCC radiation exposure limits set forth for an uncontrolled environment.

This equipment should be installed and operated with minimum distance of 20 cm between the radiator (antenna) and your body.

This transmitter must not be co-located or operating in conjunction with any other antenna or transmitter.

- ▶ For vehicles sold in Canada

This device complies with Industry Canada licence-exempt RSS standard(s).

Operation is subject to the following two conditions: (1) this device may not cause interference, and (2) this device must accept any interference, including interference that may cause undesired operation of the device.

FarmaSOS.com

⚠ CAUTION**■ Limitations of the pre-collision system**

The driver is solely responsible for safe driving. Always drive safely, taking care to observe your surroundings.

Do not use the pre-collision system instead of normal braking operations under any circumstances. This system will not prevent collisions or lessen damage or injuries in all cases. Do not overly rely on this system. Failure to do so may cause an accident, resulting in death or serious injury.

This system has been designed to help avoid and reduce the impact of collisions. However, the system operates differently depending on the situation (→P. 297, 299). As a result, the same level of performance may not be expected in all cases. Also, the pre-collision brakes may not operate if the driver is depressing the brake pedal or turning the steering wheel, as the system will determine such conditions as collision avoidance operations.

■ Handling the radar sensor

Observe the following to ensure the pre-collision system can function effectively. Otherwise, the system may not function correctly and could result in an accident.

- Keep the sensor and grille cover clean at all times.
Clean the sensor and grille cover with a soft cloth so you do not mark or damage them.
- Do not subject the sensor or surrounding area to a strong impact.
If the sensor moves even slightly off position, the system may malfunction. If the sensor or surrounding area is subject to a strong impact, always have the area inspected and adjusted by your Lexus dealer.
- Do not disassemble the sensor.
- Do not attach accessories or stickers to the sensor, grille cover or surrounding area.
- Do not modify or paint the sensor and grille cover.
- If the radar sensor needs to be replaced, contact your Lexus dealer.

⚠ CAUTION**■ Handling the camera sensors (if equipped)**

Observe the following to ensure that the PCS functions effectively:

- Keep the windshield clean at all times.
PCS effectiveness may be reduced due to the presence of raindrops, condensation, ice or snow on the windshield.
- Do not subject the camera sensor to a strong impact or force, and do not disassemble the camera sensor.
- Do not change the installation position of the camera sensor, or remove and reinstall it. The direction of the camera sensor is precisely adjusted.
- When the windshield fogs up, use the windshield defogger to dry the windshield. During cold weather, using the heater with air blowing to the feet may allow the upper part of the windshield to fog up, having a negative effect on the images.
- Do not place anything on the dashboard.
Images reflected on the windshield may reduce the effectiveness of the camera sensor.
- Do not scratch the camera lens, or let it get dirty.
- Do not attach a sticker or other items to the windshield near the camera sensor.

■ Headlights (vehicles with camera sensors)

- Observe the following to ensure proper near-infrared ray projection:
 - Keep the headlights clean at all times.
 - The detection performance may deteriorate if the high beams are misaligned or inoperative.
- The near-infrared ray transmitters project strong energy that is not visible. Although the transmitters normally turn off when the vehicle is stopped, never look into the headlights for your safety.

⚠ CAUTION**■ Determining the direction the driver is facing and whether the driver's eyes are open or closed (vehicles with driver monitor system)**

The direction the driver is facing and whether the driver's eyes are open or closed may not be determined correctly if the following conditions exist:

- There is an object between the driver monitor sensor and the driver's face, such as when the sensor is blocked.
- A part of the driver's face is covered.
- The sensor or the driver's face is exposed to intense light such as sunlight.
- The driving posture is improper.
- The vehicle is parked.

■ Handling the driver monitor sensor (vehicles with driver monitor system)

Observe the following to ensure the driver monitor sensor can function effectively.

Failure to do so may result in a malfunction or may prevent the system from correctly determining the direction the driver is facing and whether the driver's eyes are open or closed, resulting in an unexpected accident.

- Do not disassemble, damage, lift or pull on the sensor.
- Do not select the sensor while driving.
- Do not wet or spill water on the sensor.
- Do not drop anything on or allow anything to hit against the sensor. Do not subject the sensor to an impact.
- Make sure that there are no scratches, dirt or stickers on the side of the sensor that faces the driver.
- Do not place any objects in front of the side of the sensor that faces the driver or cover the sensor.

 CAUTION**■ Cautions regarding the assist contents of the system**

By means of alarms and brake control, the pre-collision system is intended to assist the driver in avoiding collisions through the process of LOOK-JUDGE-ACT. There are limits to the degree of assistance the system can provide, so please keep in mind the following important points.

- **Assisting the driver in watching the road**
The pre-collision system is only able to detect obstacles directly in front of the vehicle, and only within a limited range. It is not a mechanism that allows careless or inattentive driving, and it is not a system that can assist the driver in low-visibility conditions. It is still necessary for the driver to pay close attention to the vehicle's surroundings.
- **Assisting the driver in making correct judgment**
When attempting to estimate the likelihood of a collision, the only data available to the pre-collision system is that from obstacles it has detected directly in front of the vehicle. Therefore, it is absolutely necessary for the driver to remain vigilant and to determine whether or not there is a possibility of collision in any given situation.
- **Assisting the driver in taking action**
The pre-collision system's braking assist feature is designed to help reduce the severity of a collision, and so only acts when the system has judged that a collision is unavoidable. This system is not capable of automatically avoiding a collision or bringing the vehicle to a stop safely without appropriate operations performed by the driver. For this reason, when encountering a dangerous situation the driver must take direct and immediate action in order to ensure the safety of all involved.

 NOTICE**■ Precautions for cleaning the driver monitor sensor (vehicles with driver monitor system)**

- Gently wipe the sensor with a soft cloth to prevent damage.
- Wipe any excess dirt with a cloth dampened with neutral detergent, all liquids having been wringed out of the cloth. After that, wipe again with a dry cloth.
- Do not use benzene, thinner, glass cleaners, wax, etc.

BSM (Blind Spot Monitor)*

Summary of the Blind Spot Monitor

The Blind Spot Monitor is a system that has 2 functions;

- The Blind Spot Monitor function
 - Assists the driver in making the decision when changing lanes
- The Rear Cross Traffic Alert function
 - Assists the driver when backing up

These functions use same sensors.

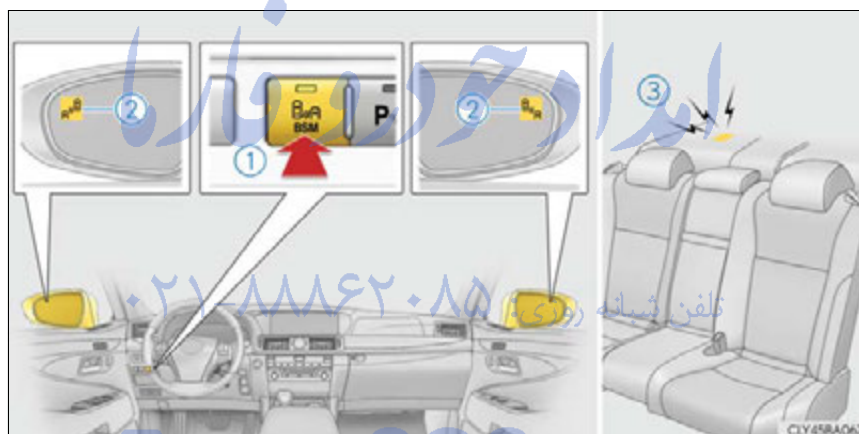

① BSM main switch

Pressing the switch turns the system on or off. When the switch is set to on, the switch's indicator illuminates and the buzzer sounds. Common switch for Blind Spot Monitor function and Rear Cross Traffic Alert function.

*: If equipped

② Outside rear view mirror indicators

Blind Spot Monitor function:

When a vehicle is detected in the blind spot, the outside rear view mirror indicator comes on while the turn signal lever is not operated and the outside rear view mirror indicator flashes while the turn signal lever is operated.

Rear Cross Traffic Alert function:

When a vehicle approaching from the right or left rear of the vehicle is detected, the outside rear view mirror indicators flash.

③ Rear Cross Traffic Alert buzzer (Rear Cross Traffic Alert function only)

When a vehicle approaching from the right or left rear of the vehicle is detected, a buzzer sounds from behind the rear seat.

■ The outside rear view mirror indicators visibility

When under strong sunlight, the outside rear view mirror indicator may be difficult to see.

■ Rear Cross Traffic Alert buzzer hearing

Rear Cross Traffic Alert function may be difficult to hear over loud noises such as high audio volume.

■ When there is a malfunction in the Blind Spot Monitor

If a system malfunction is detected due to any of the following reasons, warning messages will be displayed: (→P. 514)

- There is a malfunction with the sensors
- The sensors have become dirty
- The outside temperature is extremely high or low
- The sensor voltage has become abnormal

■ **Certification for the Blind Spot Monitor**

► For vehicles sold in the U.S.A.

FCC ID : OAYSRR2A

This device complies with part 15 of the FCC Rules. Operation is subject to the following two conditions:

- (1) This device may not cause harmful interference, and
- (2) this device must accept any interference received, including interference that may cause undesired operation.

FCC Warning

Changes or modifications not expressly approved by the party responsible for compliance could void the user's authority to operate the equipment.

► For vehicles sold in Canada

Applicable law : Canada 310

This device complies with Industry Canada licence-exempt RSS standard(s). Operation is subject to the following two conditions: (1) this device may not cause interference, and (2) this device must accept any interference, including interference that may cause undesired operation of the device.

Frequency bands : 24.05 - 24.25GHz

Output power : less than 20 milliwatts

تلفن شبانه روزی: ۰۲۱-۸۸۸۶۲۰۸۵

FarmaSOS.com

⚠ CAUTION**■ Handling the radar sensor**

One Blind Spot Monitor sensor is installed inside the left and right side of the vehicle rear bumper respectively. Observe the following to ensure the Blind Spot Monitor can function correctly.

- Keep the sensor and its surrounding area on the bumper clean at all times.



- Do not subject the sensor or surrounding area on the bumper to a strong impact. If the sensor moves even slightly off position, the system may malfunction and vehicles that enter the detection area may not be detected. If the sensor or surrounding area is subject to a strong impact, always have the area inspected by your Lexus dealer.
- Do not disassemble the sensor.
- Do not attach accessories or stickers to the sensor or surrounding area on the bumper.
- Do not modify the sensor or surrounding area on the bumper.
- Do not paint the sensor or surrounding area on the bumper.

The Blind Spot Monitor function

The Blind Spot Monitor function uses radar sensors to detect vehicles that are traveling in an adjacent lane in the area that is not reflected in the outside rear view mirror (the blind spot), and advises the driver of the vehicles existence via the outside rear view mirror indicator.

The Blind Spot Monitor function detection areas

The areas that vehicles can be detected in are outlined below.

The range of the detection area extends to:

- ① Approximately 11.5 ft. (3.5 m) from the side of the vehicle
The first 1.6 ft. (0.5 m) from the side of the vehicle is not in the detection area
- ② Approximately 9.8 ft. (3 m) from the rear bumper
- ③ Approximately 3.3 ft. (1 m) forward of the rear bumper

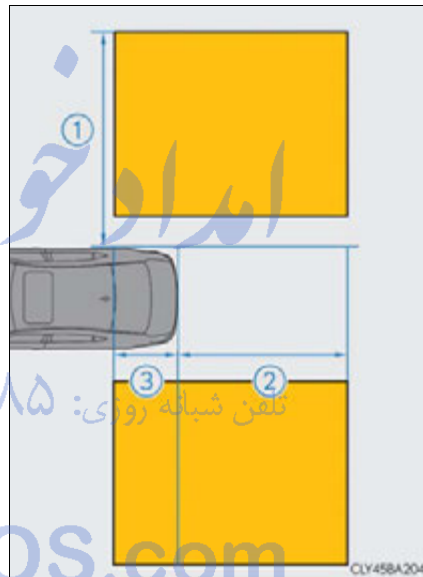

⚠ CAUTION

■ Cautions regarding the use of the system

The driver is solely responsible for safe driving. Always drive safely, taking care to observe your surroundings.

The Blind Spot Monitor function is a supplementary function which alerts the driver that a vehicle is present in the blind spot. Do not overly rely on the Blind Spot Monitor function. The function cannot judge if it is safe to change lanes, therefore over reliance could cause an accident resulting in death or serious injury.

According to conditions, the system may not function correctly. Therefore the driver's own visual confirmation of safety is necessary.

■ The Blind Spot Monitor function is operational when

- The BSM main switch is set to on
- Vehicle speed is greater than approximately 10 mph (16 km/h).

■ The Blind Spot Monitor function will detect a vehicle when

- A vehicle in an adjacent lane overtakes your vehicle.
- Another vehicle enters the detection area when it changes lanes.

■ Conditions under which the Blind Spot Monitor function will not detect a vehicle

The Blind Spot Monitor function is not designed to detect the following types of vehicles and/or objects:

- Small motorcycles, bicycles, pedestrians etc. *
- Vehicles traveling in the opposite direction
- Guardrails, walls, signs, parked vehicles and similar stationary objects *
- Following vehicles that are in the same lane *
- Vehicles driving 2 lanes across from your vehicle *

*: Depending on conditions, detection of a vehicle and/or object may occur.

تلفن شبانه روزی: ۰۲۱-۸۸۶۲۰۸۵

FarmaSOS.com

■ Conditions under which the Blind Spot Monitor function may not function correctly

- The Blind Spot Monitor function may not detect vehicles correctly in the following conditions:
 - During bad weather such as heavy rain, fog, snow etc.
 - When ice or mud etc. is attached to the rear bumper
 - When driving on a road surface that is wet due to rain, standing water etc.
 - When there is a significant difference in speed between your vehicle and the vehicle that enters the detection area
 - When a vehicle is in the detection area from a stop and remains in the detection area as your vehicle accelerates
 - When driving up or down consecutive steep inclines, such as hills, a dip in the road etc.
 - When multiple vehicles approach with only a small gap between each vehicle
 - When vehicle lanes are wide, and the vehicle in the next lane is too far away from your vehicle
 - When the vehicle that enters the detection area is traveling at about the same speed as your vehicle
 - When there is a significant difference in height between your vehicle and the vehicle that enters the detection area
 - Directly after the BSM main switch is set to on
- Instances of the Blind Spot Monitor function unnecessarily detecting a vehicle and/or object may increase under the following conditions:
 - When there is only a short distance between your vehicle and a guardrail, wall etc.
 - When there is only a short distance between your vehicle and a following vehicle
 - When vehicle lanes are narrow and a vehicle driving 2 lanes across from your vehicle enters the detection area
 - When items such as a bicycle carrier are installed on the rear of the vehicle

The Rear Cross Traffic Alert function

The Rear Cross Traffic Alert functions when your vehicle is in reverse. It can detect other vehicles approaching from the right or left rear of the vehicle. It uses radar sensors to alert the driver of the other vehicle's existence through flashing the outside rear view mirror indicators and sounding a buzzer.

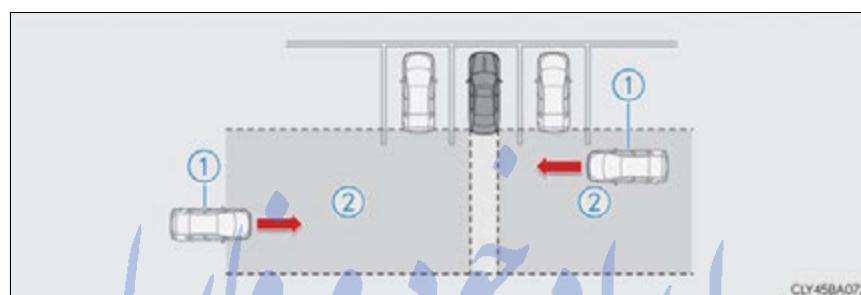

① Approaching vehicles ② Detection areas

⚠ CAUTION

■ Cautions regarding the use of the system

The driver is solely responsible for safe driving. Always drive safely, taking care to observe your surroundings.

The Rear Cross Traffic Alert function is only an assist and is not a replacement for careful driving. Driver must be careful when backing up, even when using Rear Cross Traffic Alert function. The driver's own visual confirmation of behind you and your vehicle is necessary and be sure there are no pedestrians, other vehicles etc. before backing up. Failure to do so could cause death or serious injury.

According to conditions, the system may not function correctly. Therefore the driver's own visual confirmation of safety is necessary.

The Rear Cross Traffic Alert function detection areas

The areas that vehicles can be detected in are outlined below.

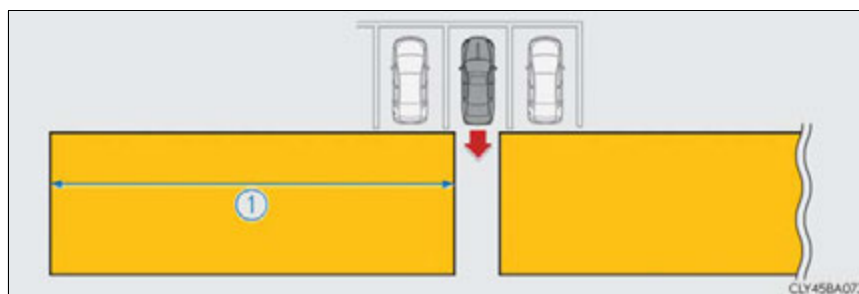

To give the driver a more consistent time to react, the buzzer can alert for faster vehicles from farther away.

Example:

Approaching vehicle	Speed	① Approximate alert distance
Fast	18 mph (28 km/h)	65 ft. (20 m)
Slow	5 mph (8 km/h)	18 ft. (5.5 m)

■ The Rear Cross Traffic Alert function is operational when

- The BSM main switch is set to on.
- The shift lever is in R.
- Vehicle speed is less than approximately 5 mph (8 km/h).
- Approaching vehicle speed is between approximately 5 mph (8 km/h) and 18 mph (28 km/h).

■ Conditions under which the Rear Cross Traffic Alert function will not detect a vehicle

The Rear Cross Traffic Alert function is not designed to detect the following types of vehicles and/or objects.

- Small motorcycles, bicycles, pedestrians etc. *
- Vehicles approaching from directly behind
- Guardrails, walls, signs, parked vehicles and similar stationary objects *
- Vehicles moving away from your vehicle
- Vehicles approaching from the parking spaces next to your vehicle *
- Vehicles backing up in the parking space next to your vehicle

*: Depending on conditions, detection of a vehicle and/or object may occur.

■ Conditions under which the Rear Cross Traffic Alert function may not function correctly

The Rear Cross Traffic Alert function may not detect vehicles correctly in the following conditions:

- During bad weather such as heavy rain, fog, snow etc.
- When ice or mud etc. is attached to the rear bumper
- When multiple vehicles approach continuously
- Shallow angle parking
- When a vehicle is approaching at high speed
- When parking on a steep incline, such as hills, a dip in the road etc.
- Directly after the BSM main switch is set to on
- Directly after the engine is started with the BSM main switch on
- Vehicles that the sensors cannot detect because of obstacles

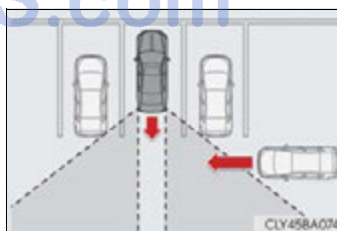

Lexus night view*

Lexus night view is a system which assists with nighttime driving.

Near-infrared rays are irradiated forward and an image converted from the irradiated light is shown on the Remote Touch screen. The image shows pedestrians, obstacles, and road conditions ahead of the vehicle, which are difficult to see at nighttime with the naked eye.

Displaying the Lexus night view

- 1 Turn the engine switch to IGNITION ON mode.
- 2 Turn the headlights on.
- 3 Press the Lexus night view switch.

The Lexus night view is displayed on the Remote Touch screen.

To return the screen to its previous state, press the switch again.

When the light sensor (→P. 233) determines that it is currently night time from the brightness of the surrounding area, the Lexus night view can be operated by pressing the Lexus night view switch while the headlights are on.

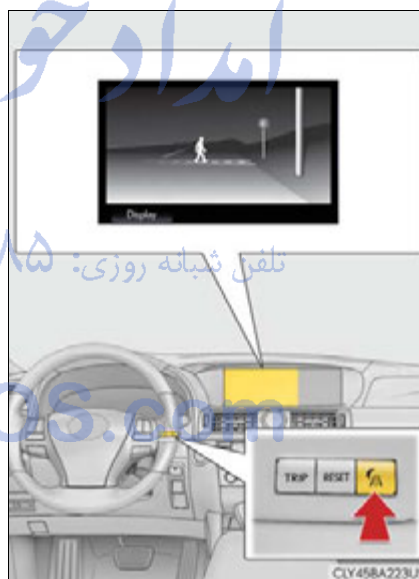

*: If equipped

The Lexus night view display

- When displaying on the main display (→P.331)



- ① Lexus night view screen
- ② Brightness adjustment button

The brightness of the display can be adjusted by selecting this button using Remote Touch.

"-": Darker

"+": Brighter

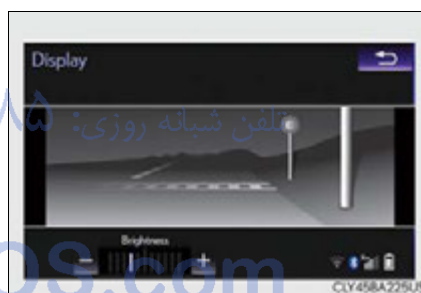

■ **When displaying on the side display**

When another screen is displayed on the main display while the Lexus night view is being shown on the main display, the Lexus night view screen will be displayed on the side display.

- ① Lexus night view screen
- ② Main display switching button

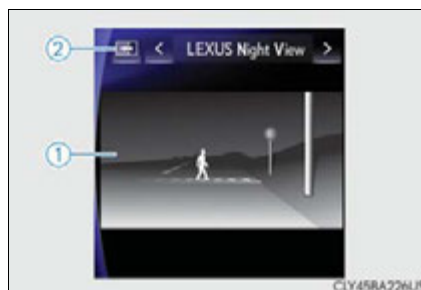

Switches the Lexus night view from the side display to the main display.

■ **Imaging range**

The image is shown ranging from the tip of the low beam to the high beam.

■ **If the vehicle speed is less than approximately 9 mph (15 km/h) when the Lexus night view is operating**

An image will be displayed on the Lexus night view screen, but both the range and the distance of the projection will be limited as near-infrared rays are not being radiated outward.

■ **When the Lexus night view switch is pressed while the Lexus night view cannot be operated**

Advice information will be displayed on the Lexus night view screen. Follow the displayed advice.

■ **If the Lexus night view switch is pressed at a time when the Lexus night view operation is not possible**

Follow the advice displayed on the Remote Touch screen.

■ **When the shift lever is shifted to R while the Lexus night view is operating**

The Lexus night view screen switches as follows.

Main display: Switches to the Lexus parking assist monitor screen.

Side display: The display blacks out and no image is displayed.

⚠ CAUTION**■ Before using the Lexus night view**

Never depend on this system only.

Lexus night view is intended as a supplemental aid to help you see pedestrians and road conditions ahead of the vehicle. As there are limits to the system, do not rely solely on the system while in use, and drive safely while observing the following precautions.

■ When using the Lexus night view

Observe the following precautions.

Failure to do so may cause an accident resulting in death or serious injury.

- Never drive while looking at the Lexus night view screen only.
- Do not look continuously at the Lexus night view screen while driving. Pedestrians, objects etc. ahead of the vehicle may be overlooked by the system. The system should always be used as a supplemental aid only.
- Lexus night view is designed to help you see objects better when driving in darkness on a road with few curves. Do not use the Lexus night view in well-lit areas or on roads with many curves or slopes. There may be areas that cannot be displayed by the system due to the road conditions (curve size, gradient, etc.)
- Lexus night view may be unable to project some features at an appropriate level of brightness. Some or all parts of certain features may be dark or difficult to see. Do not rely solely on the Lexus night view, and drive carefully while checking the surroundings for safety, as you would with a normal vehicle. Also, the following features and conditions may not be displayed clearly.

Features that are difficult to display:

- Clothing of a pedestrian made of a certain kind of material (ex. leather jackets)
- The characters on signs and billboards
- The information on road signs

Conditions in which display is difficult:

- Unfavorable weather conditions such as rain, fog, snowfall, snow storms etc.
- There are large puddles of water on the road surface following rainfall
- The area of the windshield in front of the camera is fogged up, dirty or icy
- The areas around the headlights are covered with ice, snow, mud etc.
- The battery voltage is remarkably low
- There are bright lights ahead of the vehicle

⚠ CAUTION

■ The near-infrared light

Follow these precautions to avoid damage to or incorrect operation of the Lexus night view system.

- System performance may deteriorate if the areas around the headlights are dirty. Clean the vehicle if it is dirty.
- The near-infrared ray transmitters irradiate strong energy not visible to the eyes. Do not stare at the light at close range for a long time.



⚠ NOTICE

■ The near-infrared camera

Follow these precautions to avoid damage to or incorrect operation of the Lexus night view system.

- Make sure the windshield is kept clean.
- System performance may deteriorate if rain water, condensation or ice adheres to the camera. If you notice the inner lens of the camera is dirty, the garnish will have to be replaced. Consult your Lexus dealer.
- Do not subject the camera to strong impacts, or disassemble the camera.
- As the alignment of the camera has been very finely adjusted, do not change or remove the mounting.
- If the windshield fogs up, defog the windshield using the front defroster.
- Do not dirty or scratch the camera lens.
- Night view may not function properly if an object is placed on the sensor, or anything that blocks the sensor is affixed to the windshield.

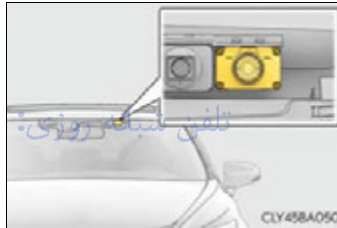

Winter driving tips

Carry out the necessary preparations and inspections before driving the vehicle in winter. Always drive the vehicle in a manner appropriate to the prevailing weather conditions.

Preparation for winter

- Use fluids that are appropriate to the prevailing outside temperatures.
 - Engine oil
 - Engine coolant
 - Washer fluid
- Have a service technician inspect the condition of the battery.
- Have the vehicle fitted with four snow tires or purchase a set of tire chains for the rear tires.

Ensure that all tires are the specified size and brand, and that chains match the size of the tires.

تلفن شبانه روزی: ۰۲۱-۸۸۶۲۰۸۵

FarmaSOS.com

Before driving the vehicle

Perform the following according to the driving conditions:

- Do not try to forcibly open a window or move a wiper that is frozen. Pour warm water over the frozen area to melt the ice. Wipe away the water immediately to prevent it from freezing.
- To ensure proper operation of the climate control system fan, remove any snow that has accumulated on the air inlet vents in front of the windshield.
- Check for and remove any excess ice or snow that may have accumulated on the exterior lights, vehicle's roof, chassis, around the tires or on the brakes.
- Remove any snow or mud from the bottom of your shoes before getting in the vehicle.

When driving the vehicle

Accelerate the vehicle slowly, keep a safe distance between you and the vehicle ahead, and drive at a reduced speed suitable to road conditions.

When parking the vehicle

Park the vehicle and move the shift lever to P without setting the parking brake. The parking brake may freeze up, preventing it from being released. If necessary, block the wheels to prevent inadvertent sliding or creeping.

Selecting tire chains

Use the correct tire chain size when mounting the tire chains.
Chain size is regulated for each tire size.

- ① Side chain
(0.12 in. [3 mm] in diameter)
- ② Cross chain
(0.16 in. [4 mm] in diameter)

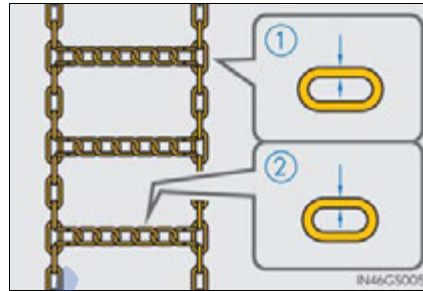

Regulations on the use of tire chains

Regulations regarding the use of tire chains vary depending on location and type of road. Always check local regulations before installing chains.

4

Driving

■ Tire chain installation

Observe the following precautions when installing and removing chains:

- Install and remove tire chains in a safe location. تلفن شبانه روزی:
- Install tire chains on the rear tires. Do not install tire chains on the front tires.
- Install tire chains on rear tires as tightly as possible. Retighten chains after driving 1/4 — 1/2 mile (0.5 — 1.0 km).
- Install tire chains following the instructions provided with the tire chains.

 CAUTION**■ Driving with snow tires**

Observe the following precautions to reduce the risk of accidents. Failure to do so may result in a loss of vehicle control and cause death or serious injury.

- Use tires of the specified size.
- Maintain the recommended level of air pressure.
- Do not drive in excess of 75 mph (120 km/h), regardless of the type of snow tires being used.
- Use snow tires on all, not just some wheels.

■ Driving with tire chains

Observe the following precautions to reduce the risk of accidents. Failure to do so may result in the vehicle being unable to be driven safely, and may cause death or serious injury.

- Do not drive in excess of the speed limit specified for the tire chains being used, or 30 mph (50 km/h), whichever is lower.
- Avoid driving on bumpy road surfaces or over potholes.
- Avoid sudden acceleration, abrupt steering, sudden braking and shifting operations that cause sudden engine braking.
- Slow down sufficiently before entering a curve to ensure that vehicle control is maintained.
- Do not use LKA (Lane-Keeping Assist) system. (if equipped)

 NOTICE**■ Repairing or replacing snow tires**

Request repairs or replacement of snow tires from Lexus dealers or legitimate tire retailers.

This is because the removal and attachment of snow tires affects the operation of the tire pressure warning valves and transmitters.

■ Fitting tire chains

The tire pressure warning valves and transmitters may not function correctly when tire chains are fitted.

Interior features

5

5-1. Remote Touch screen	5-5. Using the storage features
Remote Touch.....326	List of storage features365
12.3-inch display.....330	• Glove box367
5-2. Lexus Climate Concierge	• Coin holder368
Lexus Climate	• Door pockets.....368
Concierge333	• Cup holders369
5-3. Using the air conditioning system and defogger	• Console box.....371
Front automatic air conditioning system334	• Cool box/auxiliary box373
Rear air conditioning system352	• Auxiliary boxes376
Rear window and outside rear view mirror defoggers359	Trunk features379
Windshield wiper de-icer.....360	5-6. Other interior features
5-4. Using the interior lights	Sun visors and vanity mirrors382
Interior lights list.....361	Clock.....384
• Interior lights362	Ashtrays385
• Personal lights.....363	Cigarette lighters.....386
	Power outlets388
	Heated steering wheel392
	Climate control seats/ seat heaters394
	Armrest.....399
	Retractable table.....400
	Rear sunshade.....402
	Rear door sunshades.....406
	Trunk storage extension409
	Coat hooks411
	Assist grips.....412
	Garage door opener.....413
	LEXUS Enform Safety Connect.....420

Remote Touch

The Remote Touch can be used to operate the Remote Touch screens. For details, refer to “NAVIGATION AND MULTIMEDIA SYSTEM OWNER’S MANUAL”.

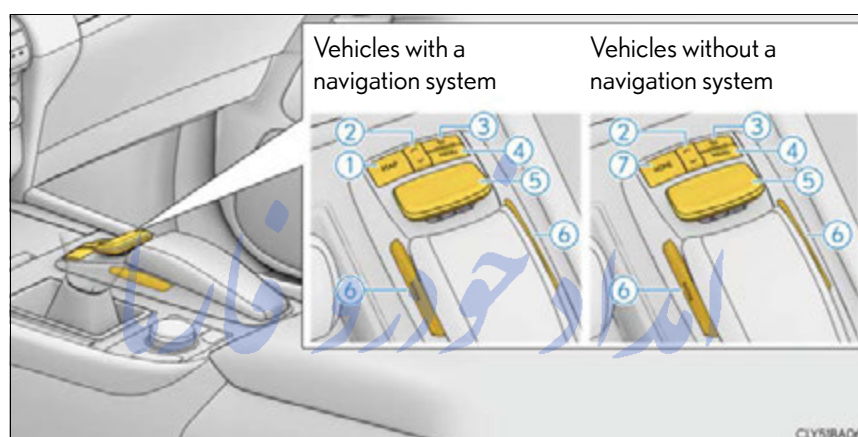

① “MAP” button

Press this button to display the current position, cancel the screen scroll, start guidance, and repeat a voice guidance.

② “^•v” button

▶ Vehicles with a navigation system

Press this button to scroll the list screen and to change the scale of the map.

▶ Vehicles without a navigation system

Press this button to scroll the list screen.

- ③ Back button
Press this button to display the previous screen.
- ④ "MENU" button
Press this button to display the "Menu" screen. (→P. 329)
- ⑤ Remote Touch knob
Move in the desired direction to select a function, letter and screen button.
Press the knob to enter the selected function, letter or screen button.
- ⑥ "ENTER" button
Press this button to enter the selected function, letter or screen button.
- ⑦ "HOME" button
Press this button to display the compass mode screen.

امداد خودرو فارما

تلفن شبانه روزی: ۰۲۱-۸۸۸۶۲۰۸۵

FarmaSOS.com

Remote Touch operation

- ① Select: Move the Remote Touch knob in the desired direction.
- ② Enter: Push the Remote Touch knob or an "ENTER" button.

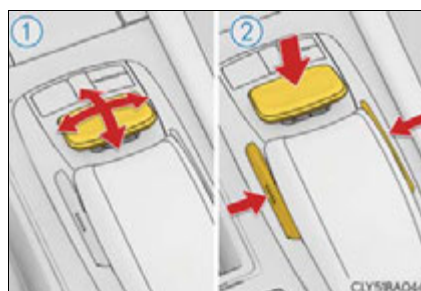

Screen display during low temperatures

When the ambient temperature is extremely low, screen response may be delayed even if the Remote Touch is operated.

⚠ CAUTION

■ When using the Remote Touch

- Do not allow fingers, fingernails or hair to become caught in the Remote Touch as this may cause an injury.
- Be careful when touching the Remote Touch in extreme temperatures as it may become very hot or cold due to the temperature inside the vehicle.

⚠ NOTICE

■ To prevent damage to the Remote Touch

- Do not allow the Remote Touch to come into contact with food, liquid, stickers or lit cigarettes as doing so may cause it to change color, emit a strange odor or stop functioning.
- Do not subject the Remote Touch to excessive pressure or strong impact as the knob may bend or break off.
- Do not allow coins, contact lenses or other such items to become caught in the Remote Touch as this may cause it to stop functioning.
- Items of clothing may rip if they become caught on the Remote Touch knob.
- If your hand or any object is on the Remote Touch knob when the engine switch is turned to ACCESSORY mode, the Remote Touch knob may not operate properly.

“Menu” screen









Press the “MENU” button on the Remote Touch to display the “Menu” screen.

The display may differ depending on the type of the system.

When the split-screen display is selected, the “Menu” screen will be displayed on the main display.

(→P. 331)



Switch	Function
 *1	Select to display the “Destination” screen.*3
	Select to display the radio control screen.*3
	Select to display the media control screen.*3
	Select to display the hands-free operation screen.*3
 *1,2	Select to display the “LEXUS App Suite” screen.*3
	Select to display the “Information” screen.*3 (→P. 103, 104)
	Select to display the air conditioning control screen. (→P. 335)
	Select to display the “Setup” screen.*3
“Display”	Select to adjust the contrast and brightness of the screens, turn the screen off, etc.*3

*1: Vehicles with a navigation system

*2: This function is not made available on some models.

*3: For details, refer to “NAVIGATION AND MULTIMEDIA SYSTEM OWNER'S MANUAL”.

12.3-inch display

12.3-inch display overview

■ Full screen display

The following functions can be displayed full screen:

- Initial screen
- "Menu" screen (→P. 329)
- Map screen*

*: For details, refer to "NAVIGATION AND MULTIMEDIA SYSTEM OWNER'S MANUAL".

امداد خودرو فارما

تلفن شبانه روزی: ۰۲۱-۸۸۸۶۲۰۸۵

FarmaSOS.com

■ Split-screen display

Different information can be displayed on the left and right of the screen. For example, audio screen can be displayed and operated while the fuel consumption information screen is being displayed.

The large screen on the left of the display is called the main display, and the small screen to the right is called the side display.



5

Interior features

تلفن شبانه روزی: ۰۲۱-۸۸۶۲۰۸۵

FarmaSOS.com

Split-screen display operation

■ Selecting the operation screen

When selecting the main display, move the Remote Touch knob to the left. When selecting the side display, move the Remote Touch knob to the right.

■ Main display

For details about the functions and operation of the main display, refer to the respective section and "NAVIGATION AND MULTIMEDIA SYSTEM OWNER'S MANUAL".

■ Side display

▶ Basic screens

To change the screen displayed on the side display, use the screen buttons on the right side of the display.

① Navigation system*

② Audio*

③ Phone*

④ Vehicle information
(→P.106)

⑤ Air conditioning system
(→P.337)



▶ Interruption screens

Each of the following screens is displayed automatically in accordance with conditions.

- Intuitive parking assist
- Phone*
- Destination Assist*
- Driving mode
- Lexus night view (if equipped) (→P. 318)

*: For details, refer to "NAVIGATION AND MULTIMEDIA SYSTEM OWNER'S MANUAL".

Lexus Climate Concierge

The climate control seats*/seat heater* on each seat and heated steering wheel* are automatically controlled according to the set temperature of the air conditioning system, outside temperature, cabin temperature, etc. Lexus Climate Concierge allows a comfortable condition to be maintained without adjusting each system.

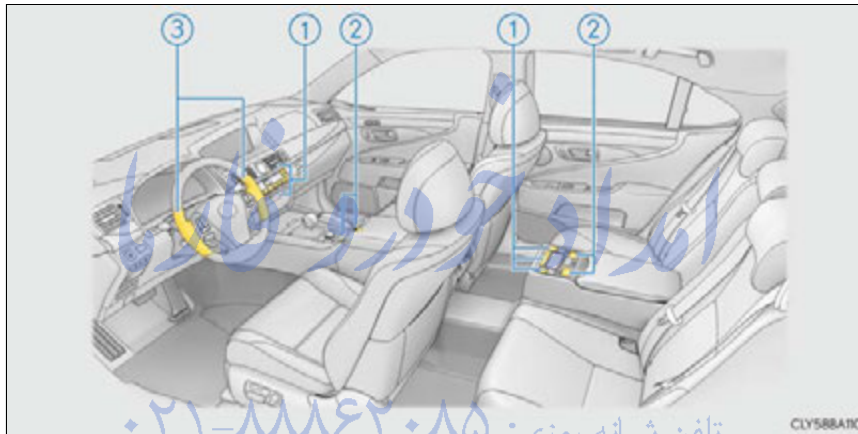

- ① Automatic air conditioning system (→P. 339, 353)

Set the air conditioning system to automatic mode.

The temperature for the driver's seat, front passenger's seat and both rear seats* can be adjusted individually.

- ② Climate control seats*/seat heaters* (→P. 394, 395)

Select "AUTO" mode on each seat.

Seat heater, off, ventilation* or seat cooler* is automatically selected according to the set temperature of the air conditioning system, outside temperature, etc.

- ③ Heated steering wheel* (→P. 392)

Turned on automatically according to the outside temperature and cabin temperature.

Operates for a maximum of 30 minutes.

*: If equipped

Front automatic air conditioning system

Air outlets and fan speed are automatically adjusted according to the temperature setting.

Press the "MENU" button on the Remote Touch, and then select  to display the air conditioning operation screen.

The air conditioning system can be displayed and operated on the side display. (→P. 331)

The display and button positions will differ depending on the type of the system.

■ Control panel



- | | |
|--|---------------------------------|
| ① Left-hand front seat side temperature control | ⑤ Outside/recirculated air mode |
| ② Left-hand front seat side temperature display | ⑥ Windshield defogger |
| ③ Right-hand front seat side temperature display | ⑦ Air outlet selector |
| ④ Right-hand front seat side temperature control | ⑧ Fan speed control |
| | ⑨ Off |
| | ⑩ Automatic mode |

■ Operation screen (Main display)

▶ Without rear air conditioning system



▶ With rear air conditioning system



5

Interior features

- ① Left-hand front seat side temperature control
- ② Fan speed control
- ③ Air flows to the feet and the windshield defogger operates
- ④ Right-hand front seat side temperature control
- ⑤ Option control screen
- ⑥ Automatic mode
- ⑦ Select to set cooling and dehumidification function on/off
- ⑧ DUAL/4-ZONE mode on/off
- ⑨ Eco mode on/off
- ⑩ Front seat air outlet selector
- ⑪ Right-hand front seat side air outlet selector
- ⑫ Left-hand front seat side air outlet selector
- ⑬ Rear air conditioning operation screen

■ Option control screen

- ▶ Without rear air conditioning system
- ▶ With rear air conditioning system



- ① Micro dust and pollen filter on/off
- ② Air purifier and rear air conditioning function on/off

■ Operation screen (Side display)

- ▶ Without rear air conditioning system ▶ With rear air conditioning system

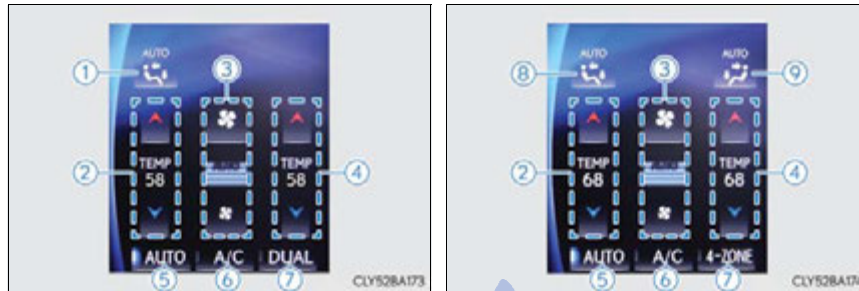

- ① Front seat air outlet selector
- ② Left-hand front seat side temperature control
- ③ Fan speed control
- ④ Right-hand front seat side temperature control
- ⑤ Automatic mode
- ⑥ Cooling and dehumidification function on/off
- ⑦ DUAL/4-ZONE mode on/off
- ⑧ Left-hand front seat side air outlet selector
- ⑨ Right-hand front seat side air outlet selector

Using the voice command system

Press  to operate the voice command system. For details, refer to "NAVIGATION AND MULTIMEDIA SYSTEM OWNER'S MANUAL".



امداد خودرو فارما

تلفن شبانه روزی: ۰۲۱-۸۸۸۶۲۰۸۵

FarmaSOS.com

Using the automatic air conditioning system

- 1 Press the "AUTO" switch or select "AUTO" on the operation screen.

The dehumidification function begins to operate. Air outlets and fan speed are automatically adjusted according to the temperature setting and humidity.

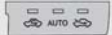
- 2 Press  to switch to automatic air intake mode.

The air conditioning system automatically switches between outside air and recirculated air modes.

- 3 Press  or select  on the operation screen to increase the temperature and  or  on the operation screen to decrease the temperature.

▶ Without rear air conditioning system

When "DUAL" is selected (the indicator will be on) or the passenger's side temperature control button is pressed, the temperature for the driver and passenger seats can be adjusted separately.

Air outlets for the driver and passenger seats may be adjusted separately depending on the temperature setting.

When the climate control seats are set to "AUTO" mode, the system is operated automatically according to the set temperature, outside temperature, etc.

▶ With rear air conditioning system

When "4-ZONE" is selected (the indicator will be on) or the passenger's side temperature control button is pressed, the temperature for the driver's, front passenger's and rear seats (→P. 352) can be adjusted separately.

Air outlets for the driver and passenger seats may be adjusted separately depending on the temperature setting.





When the climate control seats are set to "AUTO" mode, the system is operated automatically according to the set temperature, outside temperature, etc.

■ Automatic mode indicator





If the fan speed setting or air flow modes are operated, the automatic mode indicator goes off. However, automatic mode for functions other than that operated is maintained.

Adjusting the settings manually

► Without rear air conditioning system

- 1 To adjust the fan speed, press  or select  on the operation screen to increase the fan speed and  or  on the operation screen to decrease the fan speed.

Press  to turn the fan off.

- 2 To adjust the temperature setting, press  or select  on the operation screen to increase the temperature and  or  on the operation screen to decrease the temperature.

The air conditioning system switches between individual and simultaneous modes each time "DUAL" is selected.





When "DUAL" is selected (the indicator will be on) or the passenger's side temperature control button is pressed, the temperature for the driver and passenger seats can be adjusted separately.

When the climate control seats are set to "AUTO" mode, the system is operated automatically according to the set temperature, outside temperature, etc.





- 3 To change the air outlets, press  or select an air outlet switch.



► With rear air conditioning system

- 1** To adjust the fan speed, press  or select  on the operation screen to increase the fan speed and  or  on the operation screen to decrease the fan speed.

Press  to turn the fan off.

- 2** To adjust the temperature setting, press  or select  on the operation screen to increase the temperature and  or  on the operation screen to decrease the temperature.

The air conditioning system switches between individual and simultaneous modes each time "4-ZONE" is selected.

When "4-ZONE" is selected (the indicator will be on) or the passenger's side temperature control button is pressed, the temperature for the driver's, front passenger's and rear seats (→P. 352) can be adjusted separately.

When the climate control seats are set to "AUTO" mode, the system is operated automatically according to the set temperature, outside temperature, etc.

- 3** To change the air outlets, press  or select an air outlet switch.

- ① Left-hand front seat
- ② Right-hand front seat

Different air outlets for the driver and front passenger seats can be chosen.



Defogging the windshield

Press .

The dehumidification function operates and fan speed increases.

Set the outside/recirculated air mode button to outside air mode if the recirculated air mode is used. (It may switch automatically.)

To defog the windshield and the side windows early, turn the air flow and temperature up.

To return to the previous mode, press  again when the windshield is defogged.

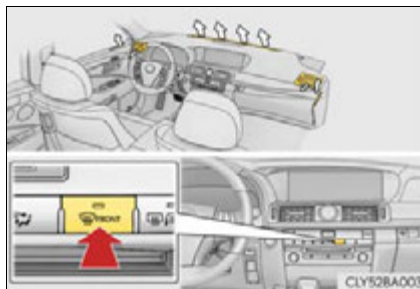

Air outlets and air flow

Upper body

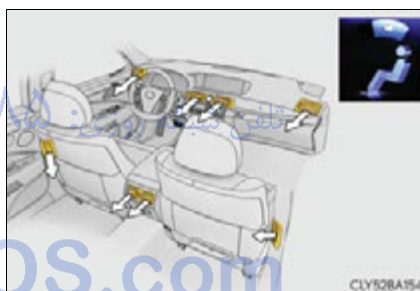

Upper body and feet

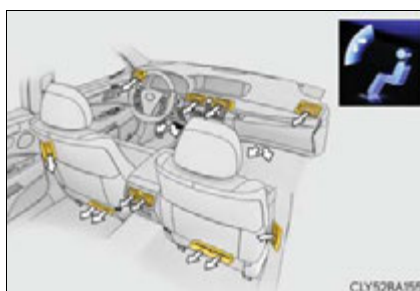

Feet

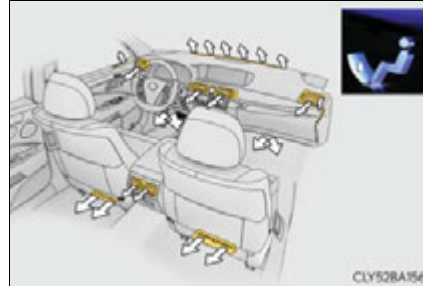

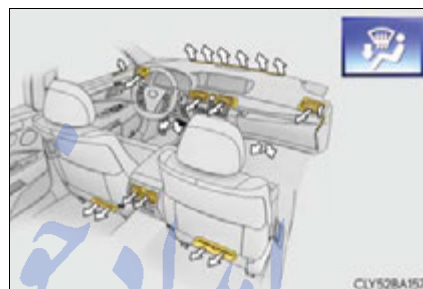

Feet and windshield



Switching between outside air and recirculated air modes

Press  .

The mode switches among  (recirculated air mode), automatic and  (outside air mode) modes each time the button is pressed.

When the system is switched to automatic mode, the air conditioning system operates automatically.

Turning the air purifier off (with rear air conditioning system)

1 Select  on the operation screen.

2 Select "Air Purifier".

The air purifier will turn off when the indicator on the switch goes off. Air will not flow from the roof vents.

To turn the air purifier on, select "Air Purifier" again.

Changing the rear seat settings (with rear air conditioning system)

■ Using the automatic mode



1 Select  on the operation screen.

2 Select "REAR AUTO".

The air conditioning system and air purifier will operate, and air outlets and speed will be set automatically.

The rear climate control seats are operated automatically according to the set temperature and the outside temperature. (→P. 394)





3 Select  to increase the temperature and  to decrease the temperature on the operation screen.

Air outlets for the right-hand and left-hand seats may be set separately depending on the temperature setting.

When the rear climate control seats are set to "AUTO" mode, the system is operated automatically according to the set temperature, outside temperature, etc.

FarmaSOS.com

■ Adjusting the temperature setting

- 1 Select  on the operation screen.
- 2 Select  (increase) or  (decrease).

Operating the switch will enter individual mode.



- ① Left-hand rear seat
- ② Right-hand rear seat



The air conditioning system switches between individual and simultaneous modes each time "4-ZONE" is selected.



When the rear climate control seats are set to "AUTO" mode, the system is operated automatically according to the set temperature, outside temperature, etc.

■ Adjusting the fan speed (air purifier and cool air from the roof vents)

- 1 Select  on the operation screen.
- 2 To adjust the fan speed, select  to increase the fan speed and  to decrease the fan speed.

According to the air outlets currently selected, the fan speed of either the cool air from the roof vents or air purifier will be adjusted. (→P. 356)

■ Turning the rear air conditioning system off

- 1 Select  on the operation screen.
- 2 Select  on the operation screen.

The air purifier and the rear climate control seats also turn off.

■ Disabling the switches on the rear controller

1 Select  on the operation screen.

2 Select .

Rear climate control seats buttons are also locked.

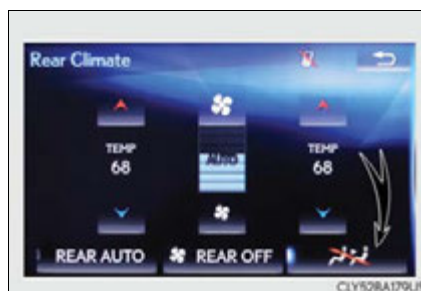

Micro dust and pollen filter button

1 Select  on the operation screen.

2 Select .

Outside air mode switches to  (recirculated air) mode. Pollen is removed from the air and the air flows to the upper part of the body.

Usually the system will turn off automatically after approximately 1 to 3 minutes.

تلفن شبانه روزی: ۰۲۱-۸۸۸۶۲۰۸۵

FarmaSOS.com

Adjusting the position of and opening and closing the air outlets

■ Front center outlets and front side outlets

- ① Direct air flow to the left or right, up or down.
- ② Turn the knob to open or close the vent.

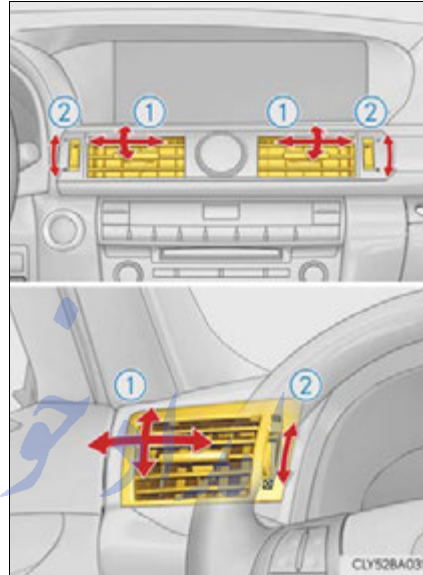

■ Rear center outlets

- ▶ Without rear console display
- ▶ With rear console display

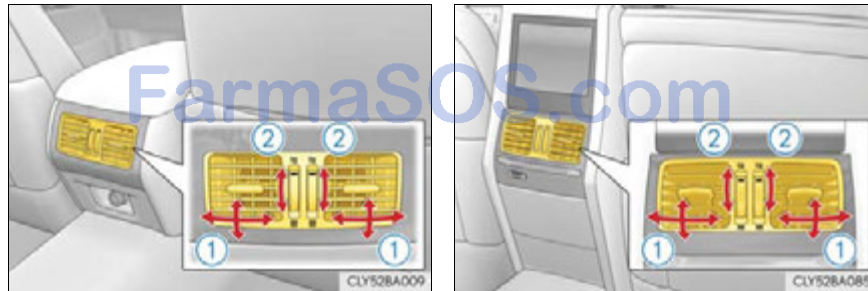

- ① Direct air flow to the left or right, up or down.
- ② Turn the knob to open or close the vent.

■ Rear side outlets

- ① Direct air flow to the left or right, up or down.
- ② Turn the knob to open or close the vent.

**■ Roof side outlets (with rear air conditioning system)**

Direct air flow to the left or right, up or down.

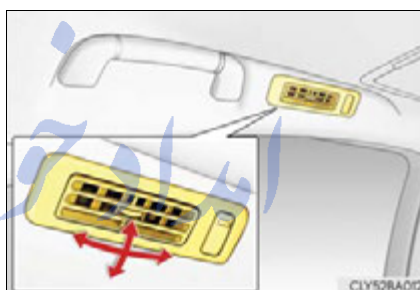

تلفن شبانه روزی: ۰۲۱-۸۸۸۶۲۰۸۵

FarmaSOS.com

■ Operation of the air conditioning system in Eco drive mode

- In the Eco drive mode, the air conditioning system is controlled as follows to prioritize fuel efficiency
 - Engine speed and compressor operation controlled to restrict heating/cooling capacity
 - Fan speed restricted when automatic mode is selected
- To improve air conditioning performance, perform the following operations
 - Adjust the fan speed
 - Turn off Eco drive mode

■ Using the automatic mode

Fan speed is adjusted automatically in accordance with the temperature setting and ambient conditions. As a result, the following may occur:

- Immediately after the "AUTO" switch is pressed, the fan may stop for a while until warm or cool air is ready to flow.
- Cool air may flow to the area around the upper body when the heater is on.

■ Fogging up of the windows

- The windows will easily fog up when the humidity in the vehicle is high. Selecting "A/C" on will dehumidify the air from the outlets and defog the windshield effectively.
- If you turn "A/C" off, the windows may fog up more easily.
- The windows may fog up if the recirculated air mode is used.

■ Outside/recirculated air mode

- When driving on dusty roads such as tunnels or in heavy traffic, set the outside/recirculated air mode button to the recirculated air mode. This is effective in preventing outside air from entering the vehicle interior. During cooling operation, setting the recirculated air mode will also cool the vehicle interior effectively.
- Outside/recirculated air mode may automatically switch depending on the temperature setting or the inside temperature.

■ When the outside temperature exceeds 75°F (24°C) and the air conditioning system is on



- In order to reduce the air conditioning power consumption, the air conditioning system may switch to recirculated air mode automatically. This may also reduce fuel consumption.
- Recirculated air mode is selected as a default mode when the engine switch is turned on.
- It is possible to switch to outside air mode at any time by pressing .

■ Automatic mode for air intake control

In automatic mode, the system detects exhaust gas and other pollutants and automatically switches between outside air and recirculated air modes.

When the dehumidification function is off, and the fan is operating, turning automatic mode on will activate the dehumidification function.

■ Micro dust and pollen filter

- In order to prevent the windshield from fogging up when the outside air is cold, the following may occur:
 - Outside air mode does not switch to  (recirculated air) mode.
 - The dehumidification function operates.
 - The operation cancels after approximately 1 minute.
- In rainy weather, the windows may fog up. Press .
- In extremely humid weather, the windows may fog up.
- The pollens are filtered out even if the micro dust and pollen filter is turned off.

■ Air purifier (with rear air conditioning system)

The air purifier will turn on when turning the rear air conditioning system on.

■ When the outside temperature falls to nearly 32°F (0°C)

The dehumidification function may not operate even when "A/C" is selected.

■ Ventilation and air conditioning odors

- To let fresh air in, set the air conditioning system to the outside air mode.
- During use, various odors from inside and outside the vehicle may enter into and accumulate in the air conditioning system. This may then cause odor to be emitted from the vents.
- To reduce potential odors from occurring:
 - It is recommended that the air conditioning system be set to outside air mode prior to turning the vehicle off.
 - The start timing of the blower may be delayed for a short period of time immediately after the air conditioning system is started in automatic mode.

■ Air conditioning filter

→P. 480

■ Customization

Some functions can be customized. (Customizable features →P. 577)

⚠ CAUTION

■ To prevent the windshield from fogging up

Do not use  during cool air operation in extremely humid weather. The difference between the temperature of the outside air and that of the windshield can cause the outer surface of the windshield to fog up, blocking your vision.

⚠ NOTICE

■ To prevent battery discharge

Do not leave the air conditioning system on longer than necessary when the engine is stopped.

Rear air conditioning system*

Air outlets and fan speed are automatically adjusted according to the temperature setting.

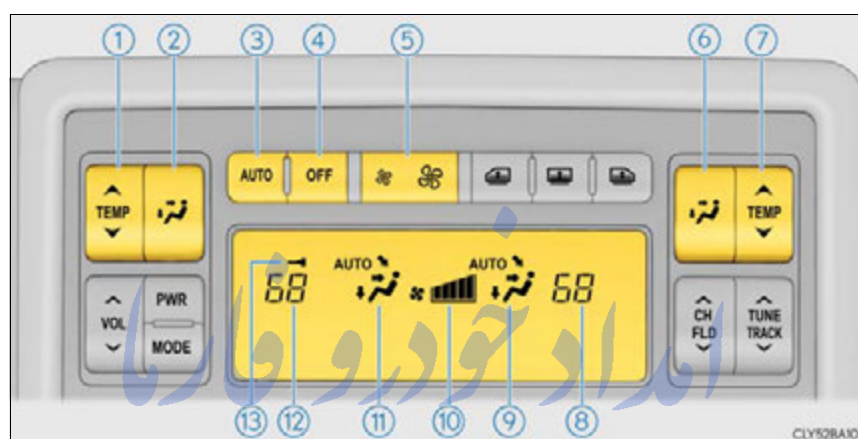

- | | |
|---|---|
| ① Left-hand rear seat side temperature control | ⑧ Right-hand rear seat side temperature display |
| ② Left-hand rear seat side air outlet selector | ⑨ Right-hand rear seat side air flow display |
| ③ Automatic mode | ⑩ Fan speed display |
| ④ Off | ⑪ Left-hand rear seat side air flow display |
| ⑤ Fan speed control | ⑫ Left-hand rear seat side temperature display |
| ⑥ Right-hand rear seat side air outlet selector | ⑬ Button lock display |
| ⑦ Right-hand rear seat side temperature control | |

*: If equipped

Using automatic air conditioning system

- 1 Press the "AUTO" button.

The air conditioning system will operate, and air outlets and fan speed will be adjusted automatically.

"AUTO" will be displayed on the control panel.

- 2 Press "∧" on "TEMP" to increase the temperature and "∨" to decrease the temperature.

The temperature for the right-hand and left-hand seats can be adjusted separately.

Air outlets for the right-hand and left-hand seats may be set separately depending on the temperature setting.

When the rear climate control seats are set to "AUTO" mode, the system is operated automatically according to the set temperature, outside temperature, etc.

Adjusting the settings manually

■ Adjusting the temperature setting

Press "∧" on "TEMP" to increase the temperature and "∨" to decrease the temperature.

The temperature for the right-hand and left-hand seats can be adjusted separately.

When the rear climate control seats are set to "AUTO" mode, the system is operated automatically according to the set temperature, outside temperature, etc.

■ Changing the air outlets

Press .

The air outlets change as follows each time  is pressed.

Different air outlets for the right-hand and left-hand rear seats can be chosen.

Air flows as shown below according to the mode selected.

- ▶ When the indicator on “Air Purifier” (on the option control screen) is on

Upper body

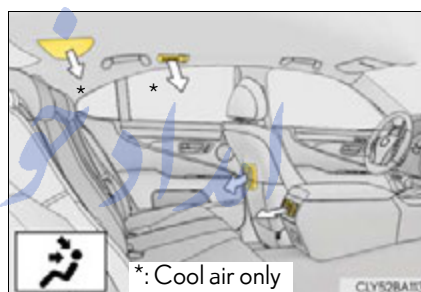

- ▶ When the indicator on “Air Purifier” (on the option control screen) is off

Upper body



Upper body and feet



Feet

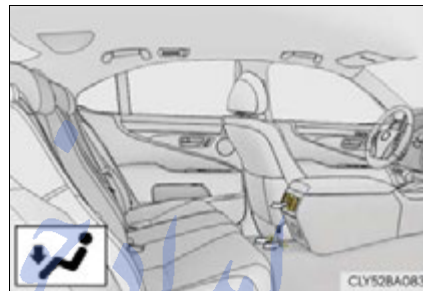

امداد خودرو فارما

تلفن شبانه روزی: ۰۲۱-۸۸۸۶۲۰۸۵

FarmaSOS.com

■ Adjusting the air volume

The volume of cool air or air from the air purifier can be adjusted according to the mode selected.

Press  (increase) or  (decrease) on .

▶ When the selected air outlets mode is 

Cool air flows from roof vents.

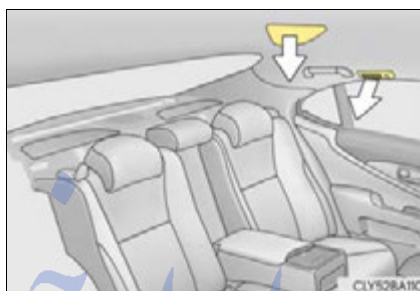

▶ When the selected air outlets mode is ,  or 

Air from the air purifier.



Press the "OFF" button to turn the fan off.

The air purifier also turn off.

Adjusting the position of and opening and closing the air outlets

■ Rear center outlets

- ▶ Without rear console display
- ▶ With rear console display

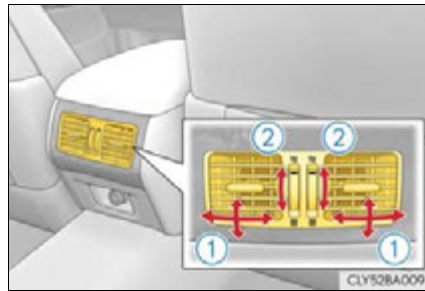

- ① Direct air flow to the left or right, up or down.
- ② Turn the knob to open or close the vent.

■ Rear side outlets

- ① Direct air flow to the left or right, up or down.
- ② Turn the knob to open or close the vent.

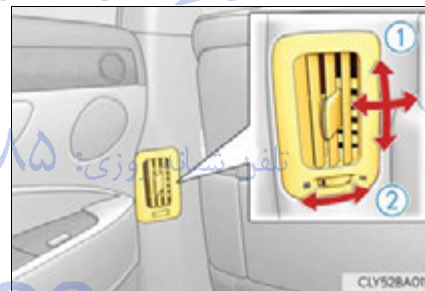

■ Roof side outlets

Direct air flow to the left or right, up or down.

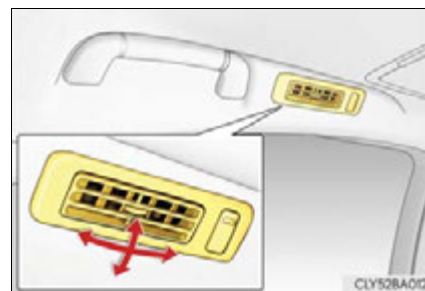

■ Button lock function

To prevent inadvertent operation, the buttons on the rear controller for the air conditioning system, rear sunshade, rear door sunshades, and audio system can be locked.

Press and hold the "MODE" switch until you hear a beep to lock the buttons. Pressing the "MODE" switch again until you hear a beep will release the lock.

An indicator appears on the display when the buttons are locked.



The rear controller can be locked from the air conditioning operation screen. (→P. 346)

■ Rear control panel illumination off function

Control panel illumination on the rear controller can be turned off.

Press and hold the "PWR" switch until you hear a beep to turn the illumination off. Pressing the "PWR" switch again until you hear a beep will turn the illumination on.



■ Replacing the rear air conditioning filter

Replacing the air conditioning filter when using rear air conditioning or air purifier reduces air flow or deodorizing performance. (→P. 480).

⚠ NOTICE

■ To prevent battery discharge

Do not leave the air conditioning system on longer than necessary when the engine is off.

Rear window and outside rear view mirror defoggers

These features are used to defog the rear window, and to remove rain-drops, dew and frost from the outside rear view mirrors.

On/off

The defoggers will automatically turn off after approximately 15 minutes.

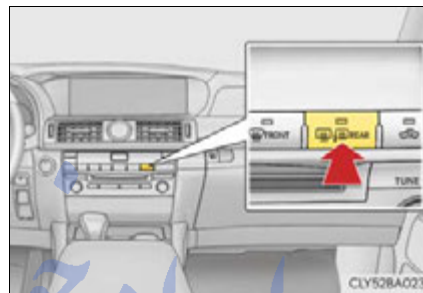

■ Operating conditions

The engine switch must be in the IGNITION ON mode.

⚠ CAUTION

■ When the outside rear view mirror defoggers are on

Do not touch the rear view mirror surfaces, as they can become very hot and burn you.



⚠ NOTICE



■ To prevent battery discharge

Turn the defoggers off when the engine is off.

Windshield wiper de-icer*

This feature is used to prevent ice from building up on the windshield and wiper blades.

- 1 Press the "MENU" button on the Remote Touch. (→P. 326)
- 2 Select  on the "Menu" screen.
- 3 Select  on the "Climate" screen.
- 4 Operates the windshield wiper de-icer on/off.

Select  on the option control screen to turn on the windshield wiper de-icer, then the indicator will be on. The windshield wiper de-icer will automatically turn off after approximately 15 minutes, then the indicator will be off. Selecting  on the option control screen again also turns the de-icer off.

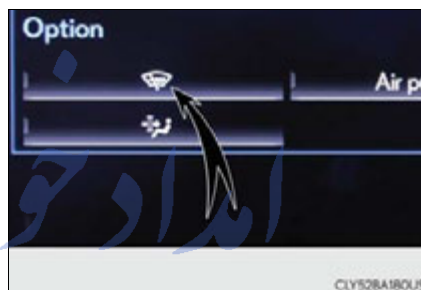

■ Operating conditions

The engine switch must be in the IGNITION ON mode.

⚠ CAUTION

■ When the windshield wiper de-icer is on

Do not touch the glass at the lower part of the windshield or to the side of the front pillars as the surfaces can become very hot and burn you.

*: If equipped

Interior lights list

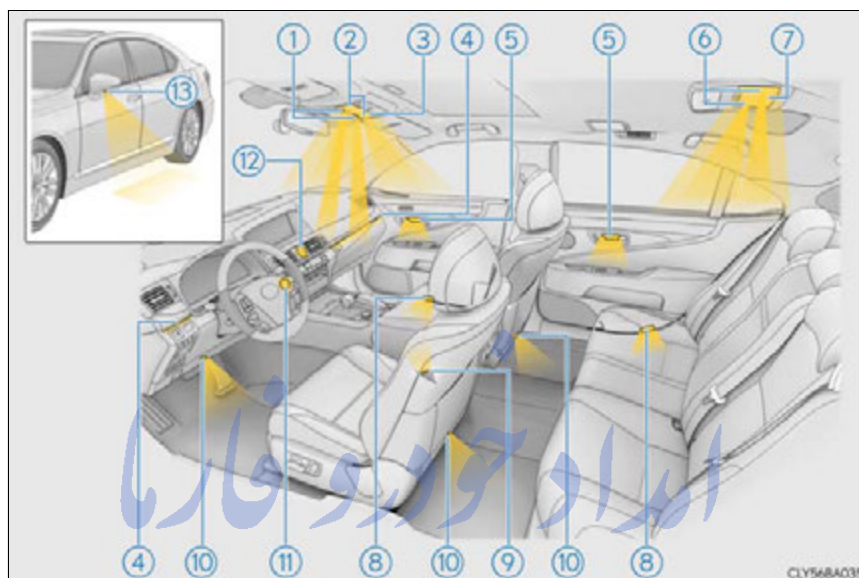

- | | |
|------------------------------------|---------------------------------|
| ① Shift lever lights | ⑦ Rear interior light (→P. 362) |
| ② Front personal lights(→P. 363) | ⑧ Door courtesy lights |
| ③ Front interior lights (→P. 362) | ⑨ Seat belt buckle lights |
| ④ Instrument panel ornament lights | ⑩ Footwell lights |
| ⑤ Inside door handle lights | ⑪ Engine switch light |
| ⑥ Rear personal lights (→P. 363) | ⑫ Clock light |
| | ⑬ Outer foot lights |

Interior lights

► Front

- ① "OFF"
- ② Door position on/off
- ③ "ON"

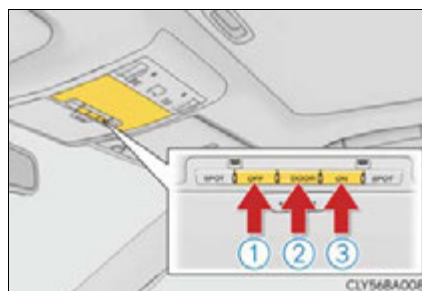

► Rear

On/off

If door position on is selected for the front interior light, the rear interior light is also turned on/off by the opening and closing of a door.

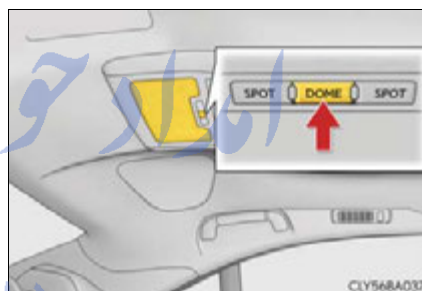

تلفن شبانه روزی: ۰۲۱-۸۸۸۶۲۰۸۵

FarmaSOS.com

Personal lights

► Front

On/off



► Rear

On/off

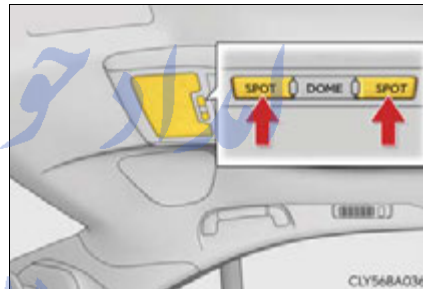

تلفن شبانه روزی: ۰۲۱-۸۸۸۶۲۰۸۵

FarmaSOS.com

■ Illuminated entry system

The lights automatically turn on/off according to engine switch mode, the presence of the electronic key, whether the doors are locked/unlocked, and whether the doors are opened/closed.

■ To prevent the battery from being discharged

If the following lights remain on when the engine switch is turned off, the lights will go off automatically after 20 minutes:

- Interior lights
- Door courtesy lights
- Personal lights
- Inside door handle lights
- Seat belt buckle lights
- Footwell lights
- Engine switch light

■ Customization

Settings (e.g. The time elapsed before lights turn off) can be changed.
(Customizable features →P. 577)

**NOTICE****■ To prevent battery discharge**

Do not leave the lights on longer than necessary when the engine is not running.

FarmaSOS.com

List of storage features

► 5-seat models

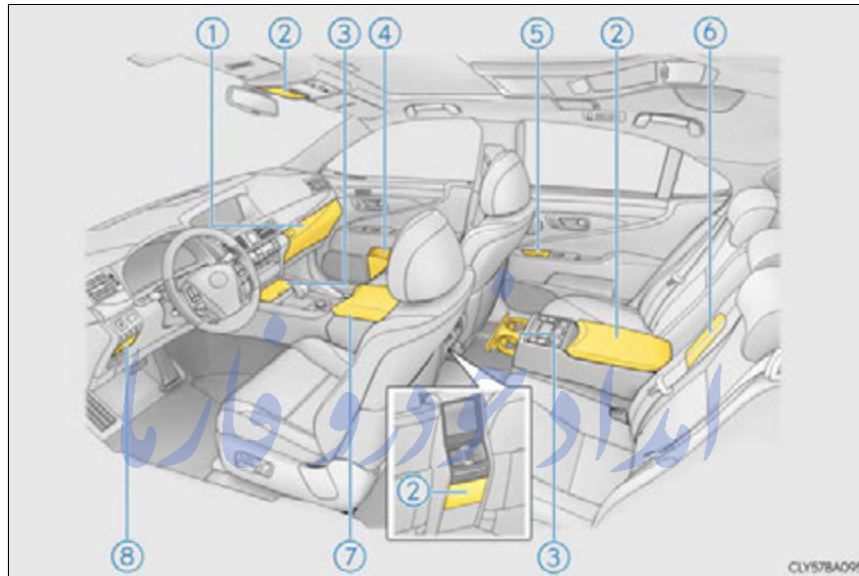

- | | |
|---|--|
| ① Glove box (→P. 367) | ⑥ Cool box/auxiliary box (if equipped) (→P. 373) |
| ② Auxiliary boxes (if equipped) (→P. 376) | ⑦ Console box (→P. 371) |
| ③ Cup holders (→P. 369) | ⑧ Coin holder (→P. 368) |
| ④ Door pockets (→P. 368) | |
| ⑤ Auxiliary boxes (if equipped) (→P. 376) | |
| Ashtrays (if equipped) (→P. 385) | |

► 4-seat models

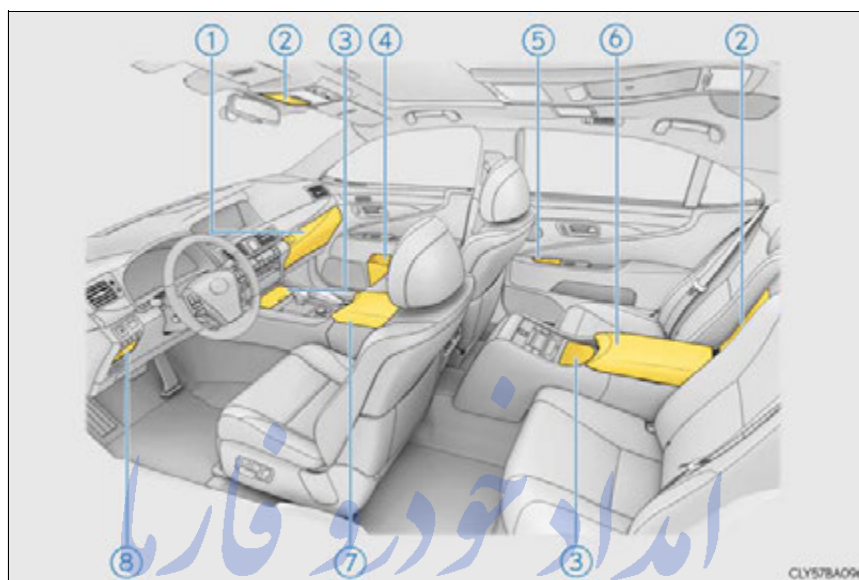

- ① Glove box (→P. 367)
 - ② Auxiliary boxes (→P. 376)
 - ③ Cup holders (→P. 369)
 - ④ Door pockets (→P. 368)
 - ⑤ Auxiliary boxes (if equipped) (→P. 376)
 - ⑥ Cool box/auxiliary box (→P. 373)
 - ⑦ Console box (→P. 371)
 - ⑧ Coin holder (→P. 368)
- Ashtrays (if equipped) (→P. 385)

⚠ CAUTION

■ Items that should not be left in the storage spaces

Do not leave glasses, lighters or spray cans in the storage spaces, as this may cause the following when cabin temperature becomes high:

- Glasses may be deformed by heat or cracked if they come into contact with other stored items.
- Lighters or spray cans may explode. If they come into contact with other stored items, the lighter may catch fire or the spray can may release gas, causing a fire hazard.

Glove box

- ① Open (push button)
- ② Unlock with the mechanical key
- ③ Lock with the mechanical key

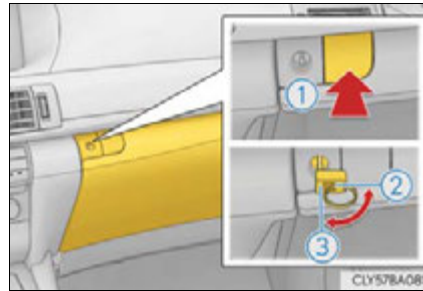

■ Glove box light

The glove box light turns on when the tail lights are on.

■ Trunk opener main switch

The trunk opener main switch is located in the glove box. (→P. 138)

■ Removing the partition

The partition inside the glove box can be removed.

Lift the front side of the partition and pull it out at an angle.

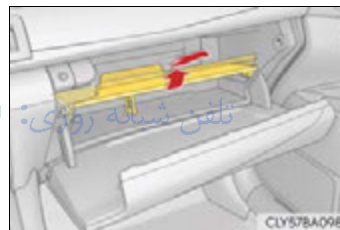

5

Interior features

⚠ CAUTION

■ Caution while driving

Keep the glove box closed. In the event of sudden braking or sudden swerving, an accident may occur due to an occupant being struck by the open glove box or the items stored inside.

Coin holder

Press in the button.



⚠ CAUTION

■ Caution while driving

Keep the coin holder closed.
Injuries may result in the event of an accident or sudden braking.

Door pockets (front)

The front door pockets can be opened and closed.



⚠ CAUTION

■ Caution while driving

Keep the door pockets closed.
Injuries may result in the event of an accident or sudden braking.

Cup holders

▶ Front

Press in and release the button.

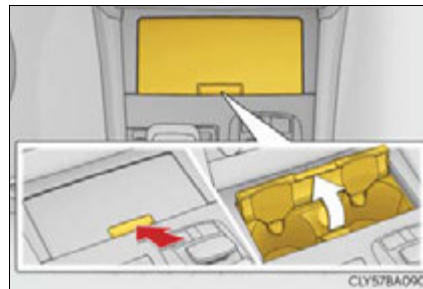

▶ Rear (5-seat models)

Press in and release the cup holder.

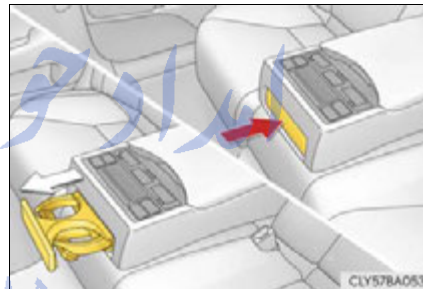

▶ Rear (4-seat models)

Press in and release the button.

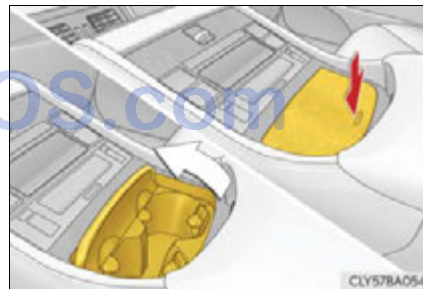

■ When stowing the rear cup holders (5-seat models)

Stow the cup holder with the armrest down. The cup holder cannot be stowed if the armrest is not down.

 CAUTION**■ Items unsuitable for the cup holder**

Do not place anything other than cups or aluminum cans in the cup holders. Other items may be thrown out of the holders in the event of an accident or sudden braking and cause injury. If possible, cover hot drinks to prevent burns.

■ To avoid burns or fires (vehicles with a cigarette lighter)

- Do not touch the metal parts of the cigarette lighter in the front cup holder.
- Do not hold the cigarette lighter in the front cup holder down. It could overheat and cause a fire.

■ When not in use

Keep the cup holders closed. Injuries may result in the event of an accident or sudden braking.

 NOTICE**■ To prevent damage to the rear cup holder (5-seat models)**

Stow the cup holder before stowing the armrest.

■ To avoid damaging the power outlet (vehicles with a power outlet)

Close the lid of the power outlet in the front cup holder when the power outlet is not in use. Foreign objects or liquids that enter the power outlet may cause a short circuit.

FarmaSOS.com

Console box

- ▶ 4-seat models or 5-seat models without rear seat entertainment system

- ① Slide the armrest while pressing the button.
- ② Lift the armrest.

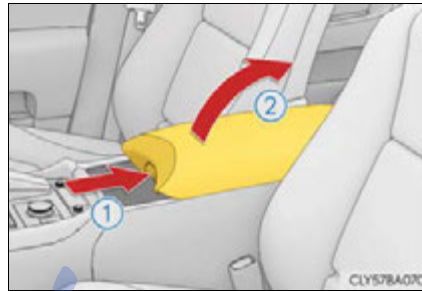

- ▶ 5-seat models with rear seat entertainment system

- ① Press the button.
- ② Lift the armrest.



- Tray in the console box (4-seat models or 5-seat models without rear seat entertainment system)

The tray can be raised backward.

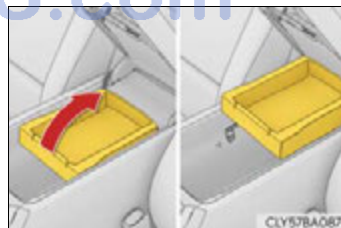

■ **Opening and closing assist function (4-seat models or 5-seat models without rear seat entertainment system)**

When the console box is opened or closed partway, this function will apply force in the appropriate direction, helping open or close the console box.

■ **Console box light**

The console box light turns on when the tail lights are on.

 **CAUTION**

■ **Caution while driving**

Keep the console box closed.
Injuries may result in the event of an accident or sudden braking.

 **NOTICE**

■ **Tray (4-seat models or 5-seat models without rear seat entertainment system)**

Do not insert items exceeding the height of the tray. Doing so may prevent opening and closing of the lid.

تلفن شبانه روزی: ۰۲۱-۸۸۶۲۰۸۵

FarmaSOS.com

Cool box/auxiliary box (if equipped)

▶ 5-seat models

- 1 Pull down the armrest. (→P. 399)
- 2 Pull the lever.

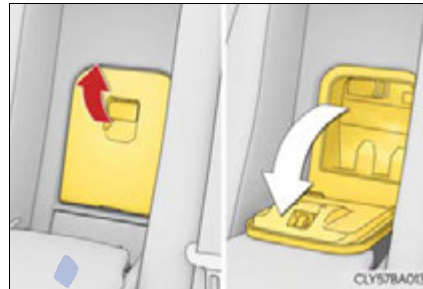

- 3 Open the cool air intake lid.

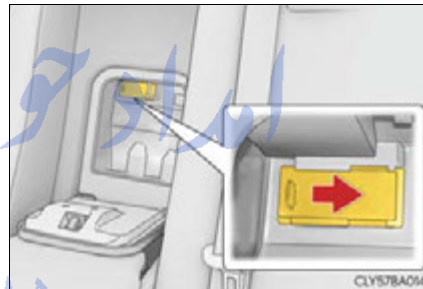

▶ 4-seat models

- 1 Pull up the lever to release the lock and lift the lid.

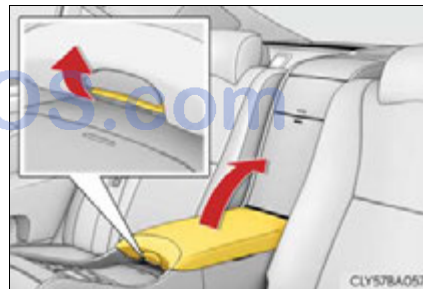

- 2 Open the cool air intake lid.

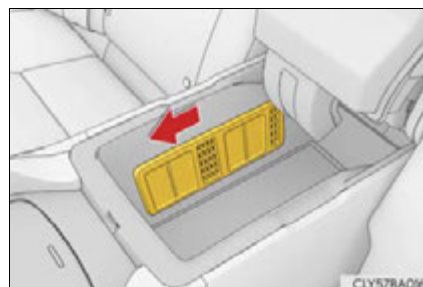

■ Cool box operating conditions

▶ 5-seat models

- The rear air conditioning system is on.
-  is displayed on the rear control panel.



▶ 4-seat models

- The rear air conditioning system is on.
-  is displayed on the rear control panel.



■ Items unsuitable for the cool box

- Drinks in unsealed containers
- Fragile items, perishables or anything with strong odor

FarmaSOS.com

■ Using a cool box as an auxiliary box**▶ 5-seat models**

Close the cool air intake lid to turn off the cool box system.

**▶ 4-seat models**

Close the cool air intake lid to turn off the cool box system.

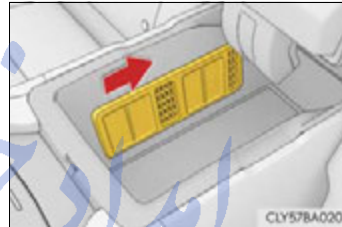
**⚠ CAUTION****■ Caution while driving**

Always keep the cool box/auxiliary box closed to reduce the chance of injury in case of an accident or sudden stop.

Auxiliary boxes

► Overhead

Press in the button.

This box is useful for temporarily storing sunglasses and similar small items.

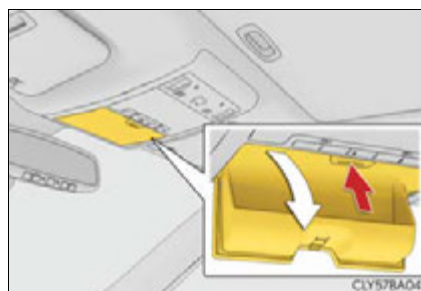

► Rear door (if equipped)

Open the lid.



► Rear seat (5-seat models)

1 Pull down the armrest. (→P. 399)

2 Press the button and lift the lid.



► Rear seat (4-seat models)

Press in the lid.

This box is useful for storing DVD discs and headphones.



► Rear console (vehicles with rear console display)

Press in the lid.

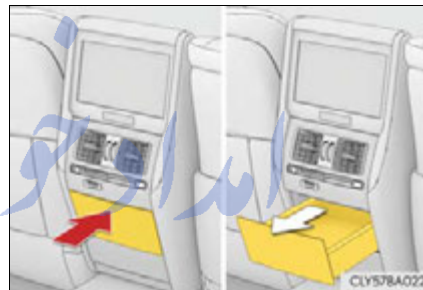

■ Tray in the rear console

The tray can be removed.



⚠ CAUTION**■ Using the auxiliary boxes (rear door)**

Do not use the auxiliary boxes as an ashtray.
Doing so may cause a fire.

■ Caution while driving

Do not leave the auxiliary box open while driving.
Items may fall out and cause death or serious injury in case of an accident or sudden stop.

■ Items unsuitable for storing (overhead)

Do not store items heavier than 0.4 lb. (0.2 kg).
Doing so may cause the auxiliary box to open and the items inside may fall out, resulting in an accident.

امداد خودرو فارما

تلفن شبانه روزی: ۰۲۱-۸۸۸۶۲۰۸۵

FarmaSOS.com

Trunk features

Cargo net

The cargo net is provided for securing loose items on the floor or items inside the trunk.

Raise the cargo hooks on the floor.
Hook the net on the cargo hooks.

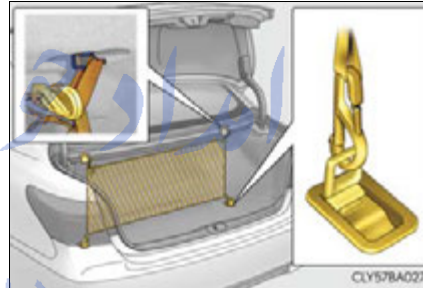
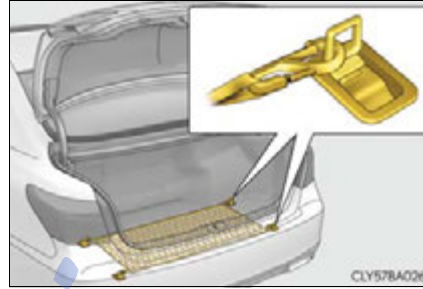

Shopping bag hooks

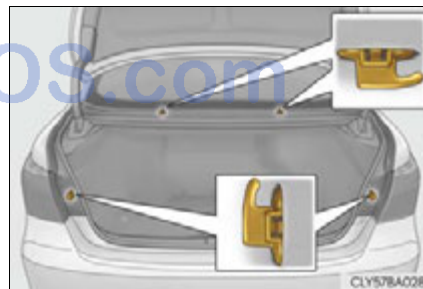

Luggage mat

► Vehicles with a spare tire

- 1 Hold the mat and lift up the luggage mat.

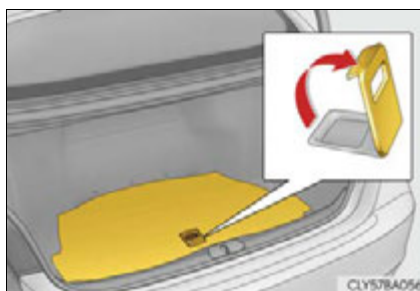

- 2 Secure the luggage mat using the hook.

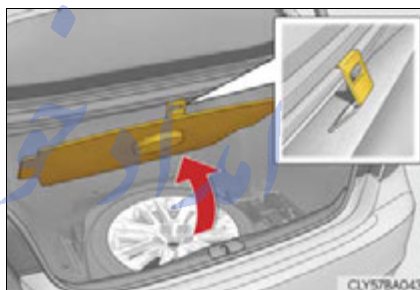

► Vehicles with run-flat tires

Lift up the handle and fold the luggage mat.



First-aid kit storage belt

- ① Loosen
- ② Tighten

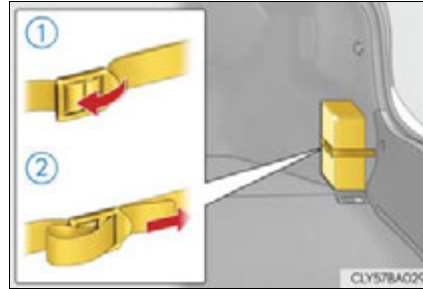
**⚠ CAUTION****■ When the cargo net is not in use**

To avoid injury, always return the cargo hooks on the floor to their stowed positions.

Sun visors and vanity mirrors

Sun visors

- ① To set the visor in the forward position, flip it down.
- ② To set the visor in the side position, flip down, unhook, and swing it to the side.
- ③ To use the side extender, place the visor in the side position, then slide it backward.

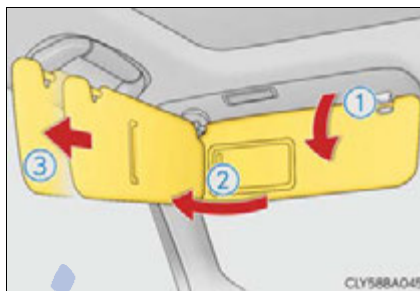

Vanity mirrors

► Front

Slide the cover to open.

The vanity light turns on.



► Rear

Press the button to open.

The vanity light turns on.

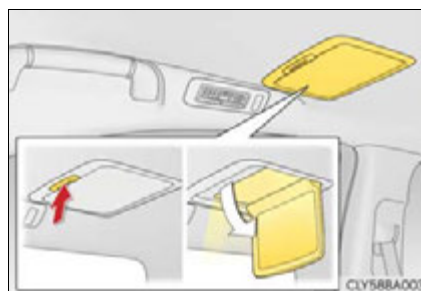

■ To prevent battery discharge

If the vanity lights remain on when the engine switch is turned off, the lights will go off automatically after 20 minutes.

 NOTICE**■ When not in use**

Keep the rear vanity mirror closed.

■ To prevent the battery from being discharged

Do not leave the vanity lights on for extended periods while the engine is stopped.

امداد خودرو فارما

تلفن شبانه روزی: ۰۲۱-۸۸۸۶۲۰۸۵

FarmaSOS.com

Clock

The GPS clock's time is automatically adjusted by utilizing GPS time information. For details, refer to "NAVIGATION AND MULTIMEDIA SYSTEM OWNER'S MANUAL".

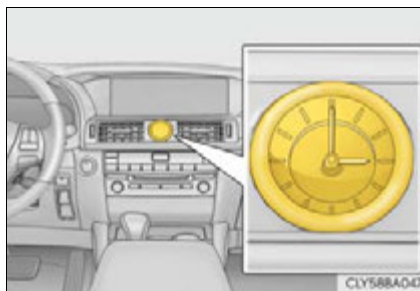

امداد خودرو فارما

تلفن شبانه روزی: ۰۲۱-۸۸۸۶۲۰۸۵

FarmaSOS.com

Ashtrays*

Open the ashtray lid.

To remove the ashtray, pull the ashtray lid upwards.

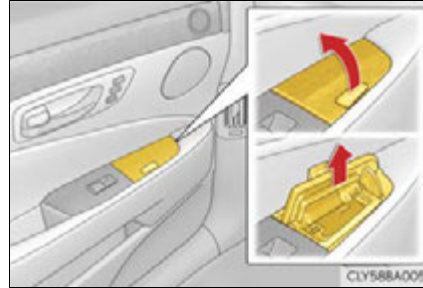

⚠ CAUTION

■ When not in use

Keep the ashtray closed. In the event of sudden braking or sudden swerving, an accident may occur due to an occupant being struck by the open ashtray or ash flying out.

■ To prevent fire

- Fully extinguish matches and cigarettes before putting them in the ashtray, then make sure the ashtray is fully closed.
- Do not place paper or any other type of flammable object in the ashtray.

5

Interior features

FarmaSOS.com

*: If equipped

Cigarette lighters*

► Front

Push the back part of the lid to open, and push the cigarette lighter down.

The cigarette lighter will pop up when it is ready for use.

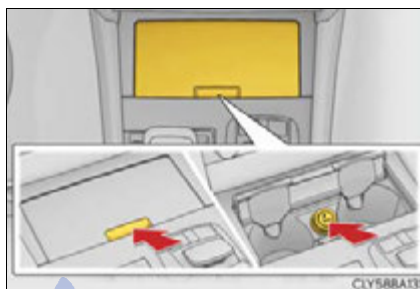

► Rear (5-seat models without rear console display)

Push the cigarette lighter.

The cigarette lighter will pop out when it is ready for use.



► Rear (4-seat models)

Open the auxiliary box and push the cigarette lighter.

The cigarette lighter will pop out when it is ready for use.



*: If equipped

■ The cigarette lighter can be used when

The engine switch is in ACCESSORY or IGNITION ON mode.

⚠ CAUTION**■ To avoid burns or fires**

- Do not touch the metal parts of the cigarette lighter.
- Do not hold the cigarette lighter down. It could overheat and cause a fire.
- Do not insert anything other than the cigarette lighter into the outlet.

■ When not in use

Keep the ashtray closed.
Injuries may result in the event of an accident or sudden braking.

امداد خودرو فارما

تلفن شبانه روزی: ۰۲۱-۸۸۸۶۲۰۸۵

FarmaSOS.com

Power outlets

The power outlet can be used for the following components:

12 V: Accessories that run on less than 10 A.

120 VAC: Accessories that use less than 100 W.

■ 12 V

▶ Front*

Push the back part of the lid to open, and open the lid.

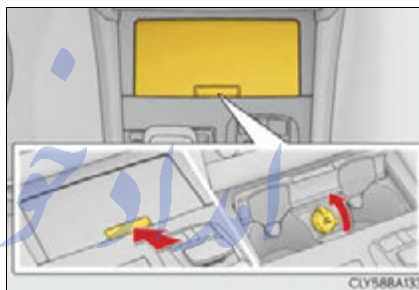

▶ Console box

Open the console box and open the lid.



- ▶ Rear (5-seat models without rear console display)*

Open the lid.

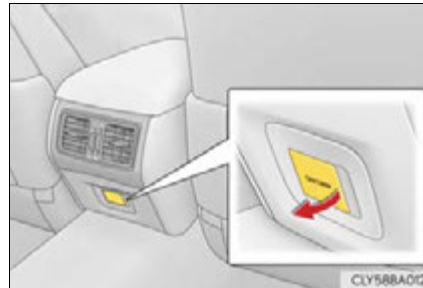

- ▶ Rear (5-seat models with rear console display)*

Push the cover to open, and open the lid.

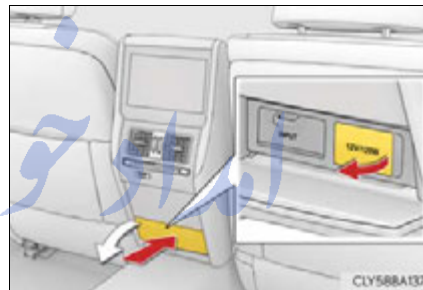

- ▶ Rear (4-seat models)*

Open the auxiliary box and open the lid.



*: If equipped

■ 120 VAC

- ▶ 4-seat models or 5-seat models without rear seat entertainment system*

Open the lid.

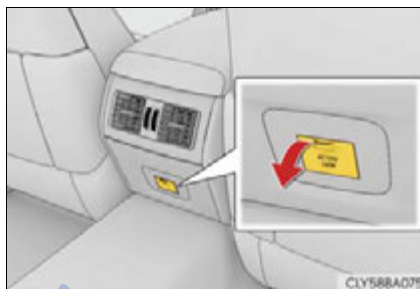

- ▶ 5-seat models with rear console display*

Push the cover to open, and open the lid.

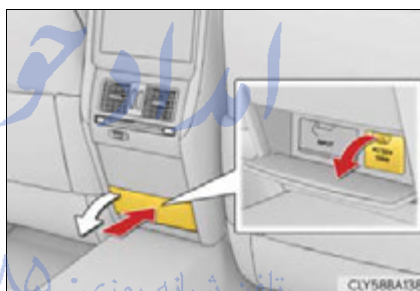

*: If equipped

■ The power outlet can be used when

- ▶ 12 V

The engine switch is in ACCESSORY or IGNITION ON mode.

- ▶ 120 VAC

The engine switch is in IGNITION ON mode.

 NOTICE**■ To avoid damaging the power outlet**

Close the power outlet lid when the power outlet is not in use.
Foreign objects or liquids that enter the power outlet may cause a short circuit.

■ To prevent the fuse from being blown

▶ 12 V

Do not use an accessory that uses more than 12 V 10 A.

▶ 120 VAC

Do not use a 120 VAC appliance that requires more than 100 W.

If a 120 VAC appliance that consumes more than 100 W is used, the protection circuit will cut the power supply.

■ To prevent the battery from being discharged

Do not use the power outlet longer than necessary when the engine is not running.

■ Appliances that may not operate properly (120 VAC)

The following 120 VAC appliances may not operate properly even if their power consumption is under 100 W.

- Appliances with high initial peak wattage
- Measuring devices that process precise data
- Other appliances that require an extremely stable power supply

Heated steering wheel*

The left and right grip portions of the steering wheel can be heated.

▶ Automatic operation

Operates automatically according to the outside and cabin temperature when the engine switch is turned to IGNITION ON mode. Automatic operation can be turned off using the switch.

The indicator light comes on when the heater is operating.

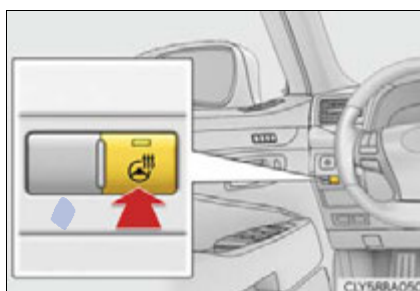

▶ Manual operation

Turns the heated steering wheel on/off.

The indicator light comes on when the heater is operating.

■ Operating condition

The engine switch is in IGNITION ON mode.

■ Timer function

Manual operation: Turns off after approximately 30 minutes.

Automatic operation: Operates for a maximum of 30 minutes. (Turns off according to outside and cabin temperature.)

■ If the indicator light does not come on

If the indicator light does not come on when the switch is pressed, a malfunction may have occurred in the system. Have the vehicle inspected by your Lexus dealer.

■ Customization

The automatic turning on/off of the heated steering wheel can be customized. (Customizable features →P. 577)

*: If equipped

⚠ CAUTION**■ Burns**

Only appropriately qualified and capable non-impaired persons should operate the vehicle. However, care should be taken to prevent injury if anyone in the following categories comes into contact with the steering wheel when the heated steering wheel is on:

- Babies, small children, the elderly, the sick and the disabled
- Persons with sensitive skin
- Persons who are fatigued
- Persons who have taken alcohol or drugs that induce sleep (sleeping drugs, cold remedies, etc.)

⚠ NOTICE**■ To prevent the battery from being discharged**

Turn the switch off when the engine is not running.

تلفن شبانه روزی: ۰۲۱-۸۸۶۲۰۸۵

FarmaSOS.com

Climate control seats^{*} / seat heaters^{*}

The seats can be heated or cooled. When set to "AUTO" mode, the climate control seats/seat heaters are linked to the air conditioning settings and automatically adjusted.

Front climate control seats (if equipped)

- 1 Press the knob to release the lock.

Press the knob to lock it when not in use.

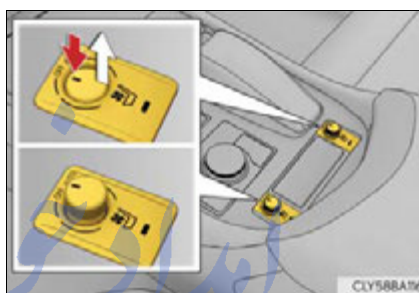

- ▶ AUTO setting

- 2 Turn the knob to the "AUTO" position.

When set to "AUTO" mode, seat heater, off, ventilation or seat cooler is automatically selected according to the set temperature of the air conditioning system, outside temperature, etc.



*: If equipped

► Manual setting

- 2 Set the temperature by turning the knob to the left or right.

- ① Off
- ② Seat heater
- ③ Ventilation
- ④ Seat cooler

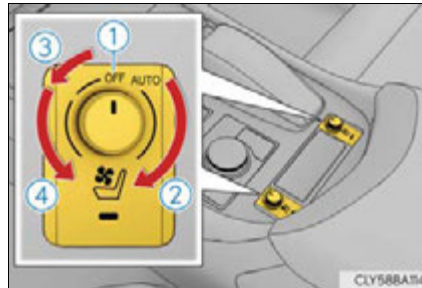

Rear climate control seats (if equipped)/seat heaters (if equipped)

► 5-seat models

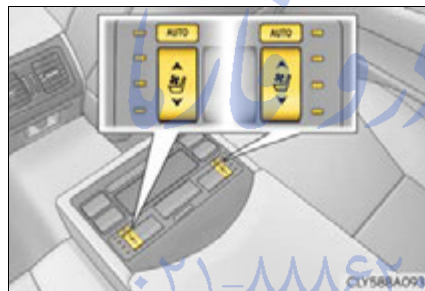

► 4-seat models



■ AUTO setting

The switch turned on/off.

When set to "AUTO" mode, the indicator illuminates.

When set to "AUTO" mode, seat heater, off, ventilation* or seat cooler* is automatically selected according to the set temperature of the air conditioning system, outside temperature, etc.

*: Vehicles with climate control seats



■ Manual setting

The strength of the seat heater and seat cooler can be adjusted to 3 levels each.

Seat heater*¹: When the system is off, pressing “▲” turns the seat heater on.

Pressing “▲” increases the level and pressing “▼” lowers the level.

Seat cooler*^{2, 3}: When the system is off, pressing “▼” turns the seat cooler on.

Pressing “▼” increases the level and pressing “▲” lowers the level.



Seat heater*¹

Seat cooler*^{2,3}

① Low

④ Low

② Mid

⑤ Mid

③ Hi

⑥ Hi

*¹: The indicator illuminates in amber.

*²: The indicator illuminates in blue.

*³: Vehicles with climate control seats

■ Operating condition

The engine switch is in IGNITION ON mode.

■ Climate control seat/seat heater operation

Depending on the outside temperature and the temperature of the seat surface, there are cases when heating operation is stronger than usual.

■ Operating the rear climate control seats from the front seats

→P. 344

■ Disabling the switches on the rear controller

→P. 346

■ Replacing the air filters

Filters are installed in the climate control seats. For replacement of the filters, contact your Lexus dealer.

■ Customization

Automatic operation settings can be customized. (Customizable features →P. 577)

تلفن شبانه روزی: ۰۲۱-۸۸۶۲۰۸۵

FarmaSOS.com

 CAUTION**■ Burns/excessive cooling**

- Use caution when seating the following persons in a seat to avoid the possibility of burns or excessive cooling:
 - Babies, small children, elderly persons, sick persons and persons with a physical disability
 - Persons who have sensitive skin
 - Persons who are fatigued
 - Persons who have taken alcohol or drugs which induce sleep, such as sleeping drugs and cold remedies
- Do not cover the seat with anything when using the climate control seat or seat heater. Using the climate control seat or seat heater with a blanket or cushion may increase or decrease the temperature of the seat, resulting in overheating or overcooling.
- Do not use the climate control seat or seat heater more than necessary. Doing so may cool the occupants excessively or may cause minor burns or overheating.

 NOTICE**■ To prevent damage to the climate control seat and seat heater**

Do not put heavy objects that have an uneven surface on the seat and do not stick sharp objects, such as needles and nails, into the seat.

■ To prevent the battery from being discharged

Do not leave the system on longer than necessary when the engine is off.

Armrest (5-seat models)

Pull the armrest down for use.



NOTICE

■ **To prevent damage to the armrest**

Do not place too much strain on the armrest.

تلفن شبانه روزی: ۰۲۱-۸۸۸۶۲۰۸۵

FarmaSOS.com

Retractable table (4-seat models)

- 1 Slide the lever to raise the table.

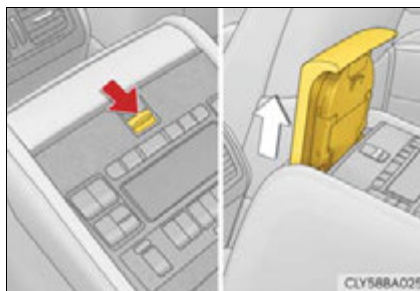

- 2 Pull the table up and pull down the table.

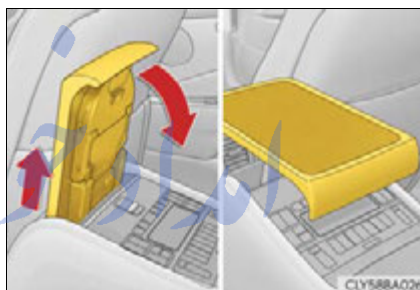

The position of the table can be changed. Before using the table, make sure that the table is securely locked.

When the table is in use, the front seats will stop if they are going to contact the table. (→P.148, 167)

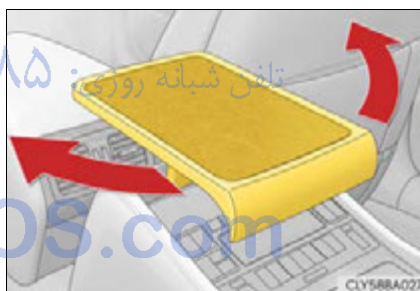

When returning the table, pull it up while pulling the lock release lever.

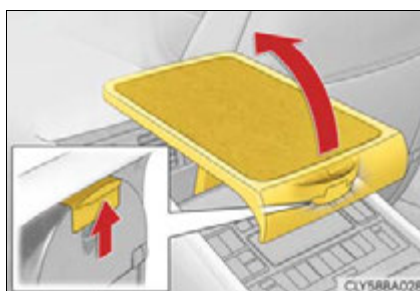

⚠ CAUTION**■ When not in use**

To avoid injury, return the table.

■ Caution while driving

Keep the table stowed properly in its place. In the event of an accident, contact with the table may result in death or serious injury.

■ When using the table

Observe the following precautions. Failure to do so may result in death or serious injury.

- Make sure the table is securely locked.
- Do not lean on the table.
- Do not put anything heavier than 22 lb. (10 kg) on the table.

⚠ NOTICE**■ To prevent damage to the table**

Do not place too much strain on the table.

امداد خودرو فارسی
تلفن شبانه روزی: ۰۲۱-۸۸۶۲۰۸۵

FarmaSOS.com

Rear sunshade*

The rear sunshade can be raised and lowered by operating any of the buttons shown below.

■ From front seat

- ▶ Vehicles without power rear seat

Extend/retract

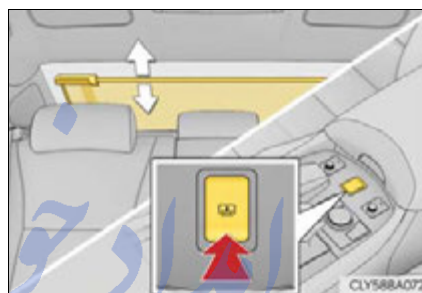

- ▶ Vehicles with power rear seat

Extend/retract

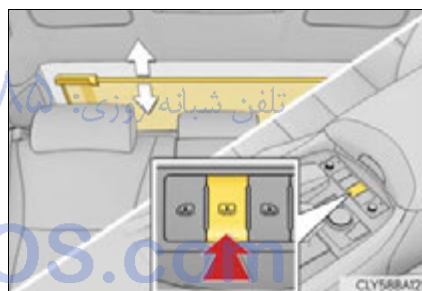

- ▶ Vehicles with relaxation seat

Extend/retract

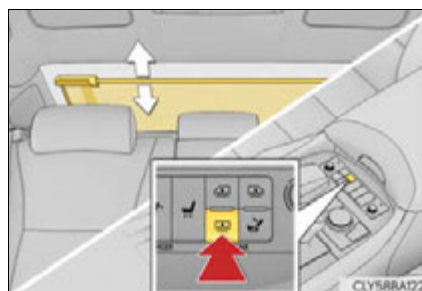

*: If equipped

■ From rear seat

- ▶ 5-seat models (vehicles without power rear seat)

Extend/retract



- ▶ 5-seat models (vehicles with power rear seat)

Extend/retract

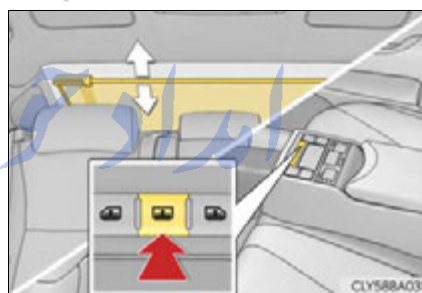

- ▶ 4-seat models تلفن شبانه روزی: ۰۸۵ ۸۸۶۲۰۲۱

Extend/retract



■ **The rear sunshade can be used when**

The engine switch is in IGNITION ON mode.

■ **Operating the rear sunshade after turning the engine switch off**

The rear sunshade can be operated for approximately 60 seconds even after the engine switch is switched to ACCESSORY mode or turned off.

■ **Reverse operation feature**

To ensure adequate rear visibility, the rear sunshade automatically lowers when the shift lever is shifted to R.

However, the rear sunshade is raised again if any of the following occurs:

- The button is pressed again.
- The shift lever is shifted to P.
- The shift lever is shifted out of P and R, and the vehicle reaches a speed of 9 mph (15 km/h).

If the engine is turned off when the rear sunshade has been lowered due to the reverse operation feature, it will not be raised even when the engine is turned on again and the vehicle reaches a speed of 9 mph (15 km/h). To raise the sunshade again, press the button.

■ **Button lock function**

To prevent inadvertent operation, some buttons on the rear controller can be locked.

(→P. 358) • ۲۱-۸۸۶۲۰۸۵ :تلفن شبانه روزی

FarmaSOS.com

 CAUTION**■ When the rear sunshade is being raised or lowered**

Do not place fingers or other objects in the shade mechanism or in the opening as injury may result.

 NOTICE**■ To prevent the battery from being discharged**

Do not operate the rear sunshade when the engine is not running.

■ To ensure normal operation of the sunshade

Observe the following precautions:

- Do not place excessive load on the motor or other components.
- Do not place objects where they may hinder opening and closing operations.
- Do not attach items to the rear sunshade.
- Keep the opening clean and clear of obstructions.
- Do not operate the rear sunshade continuously for long periods of time.

تلفن شبانه روزی: ۰۲۱-۸۸۶۲۰۸۵

FarmaSOS.com

Rear door sunshades*

The rear door sunshades can be extended and retracted by operating any of the buttons shown below.

■ From front seat

- ▶ Vehicles with power rear seat

Extend/retract

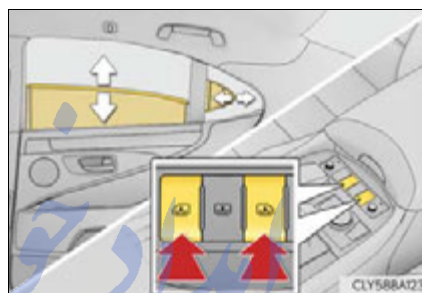

- ▶ Vehicles with relaxation seat

Extend/retract

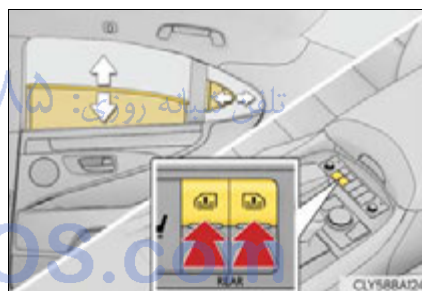

■ From rear seat

- ▶ 5-seat models

Extend/retract

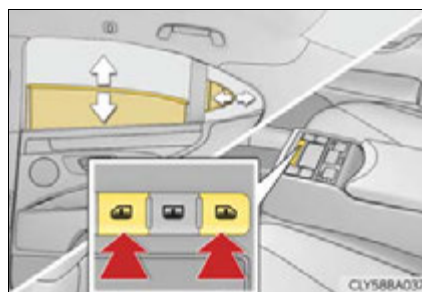

*: If equipped

▶ 4-seat models

Extend/retract

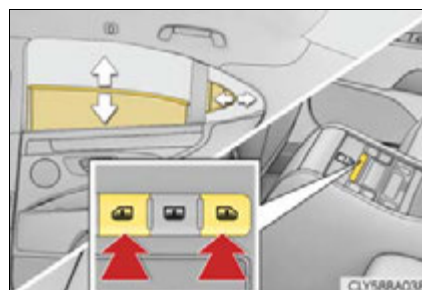

■ Operating conditions

- The engine switch is in IGNITION ON mode.
- The rear windows are fully closed.
The rear door sunshades automatically retract when the rear windows are opened.

■ Operating the rear door sunshades after turning the engine switch off

The rear door sunshades can be operated for approximately 60 seconds even after the engine switch is switched to ACCESSORY mode or turned off.

■ Jam protection function

If an object becomes caught between a rear door sunshade and the window frame, the jam protection function will cause the sunshade to detach from its drive mechanism and retract.

- ▶ If the jam protection function operates when extending the rear door sunshades

Pressing the button will reconnect the sunshade.

Pressing the button again will allow the sunshades to be operated.

If the sunshade does not operate after the button is pressed, press the button again.

- ▶ If the jam protection function operates when retracting the rear door sunshades

Press and hold the button to re-extend the rear door sunshades, and continue pressing for more than 5 seconds after the sunshades have fully extended and stopped.

■ Button lock function

To prevent inadvertent operation, some buttons on the rear controller can be locked. (→P. 358)

■ When reconnecting the battery

The rear door sunshades will always be retracted the first time the button is pressed.

 CAUTION**■ When the rear door sunshades are being extended or retracted**

Do not place fingers or other objects in the shade mechanism or in the opening as injury may result.

■ Jam protection function

Never use any part of your body to intentionally activate the jam protection function.

 NOTICE**■ To prevent the battery from being discharged**

Do not operate the rear door sunshades when the engine is not running.

■ To ensure normal operation of the sunshades

Observe the following precautions:

- Do not place excessive load on the motor or other components.
- Do not place objects where they may hinder opening and closing operations.
- Do not attach items to the rear door sunshades.
- Keep the opening clean and clear of obstructions.
- Do not operate the rear door sunshades continuously for long periods of time.

FarmaSOS.com

Trunk storage extension*

Long objects can be loaded in the vehicle by utilizing the trunk space and rear seat area.

1 Pull down the armrest. (→P. 399)

2 Open the armrest door.

The armrest door can be locked and unlocked using the mechanical key.

① Unlock

② Lock

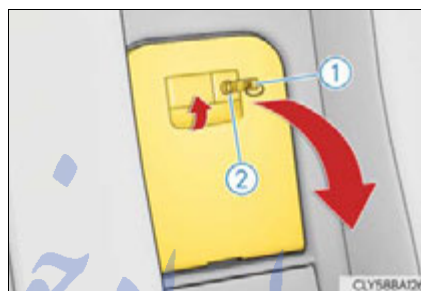

► Opening from the cabin

3 Open the inside trunk door from the cabin, and load baggage or other items.



► Opening from the trunk

3 Open the inside trunk door from the trunk, and load baggage or other items.



5

Interior features

*: If equipped

 CAUTION

■ When not in use

Ensure that the inside trunk door is closed.

In the event of sudden braking, items stored in the trunk may be thrown forward into the cabin, resulting in injury.

امداد خودرو فارما

تلفن شبانه روزی: ۰۲۱-۸۸۸۶۲۰۸۵

FarmaSOS.com

Coat hooks

- ▶ Vehicles without rear air conditioning system

To use the coat hook, push it on.

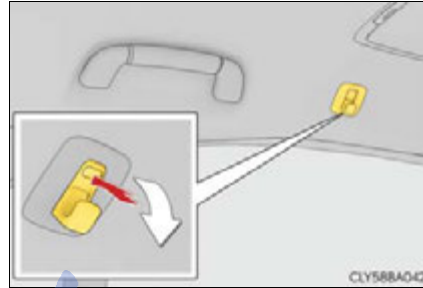

- ▶ Vehicles with rear air conditioning system

To use the coat hook, push it on.

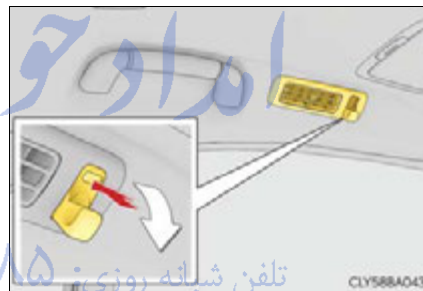

⚠ CAUTION

■ Items that must not be hung on the hook

Do not hang a coat hanger or other hard or sharp object on the hook. If the SRS curtain shield airbags deploy, these items may become projectiles that cause death or serious injury.

Assist grips

An assist grip installed on the ceiling can be used to support your body while sitting on the seat.

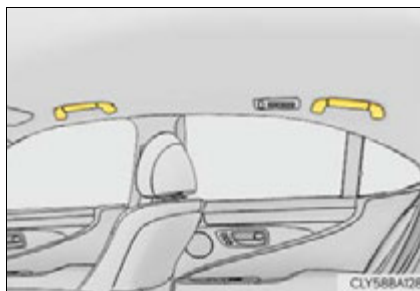

⚠ CAUTION

■ Assist grip

Do not use the assist grip when getting in or out of the vehicle or rising from your seat.
Doing so could damage the assist grip, or could cause you to injure yourself by falling over.

⚠ NOTICE

■ To prevent damage to the assist grip

Do not hang any heavy object or put a heavy load on the assist grip.

FarmaSOS.com

Garage door opener

The garage door opener can be programmed to operate garage doors, gates, entry doors, door locks, home lighting systems, security systems, and other devices.

The garage door opener (HomeLink[®] Universal Transceiver) is manufactured under license from HomeLink[®].

Programming the HomeLink[®]

The HomeLink[®] compatible transceiver in your vehicle has 3 buttons which can be programmed to operate 3 different devices. Refer to the programming method below appropriate for the device.

- ① Indicator
- ② Buttons

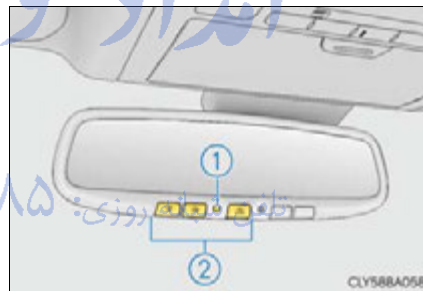

■ Programming the HomeLink[®] (for U.S.A. owners)

- 1 Point the remote control transmitter for the device 1 to 3 in. (25 to 75 mm) from the HomeLink[®] control buttons. Keep the HomeLink[®] indicator light in view while programming.



- 2 Press and hold one of the HomeLink[®] buttons and the transmitter button. When the HomeLink[®] indicator light changes from a slow to a rapid flash, you can release both buttons.

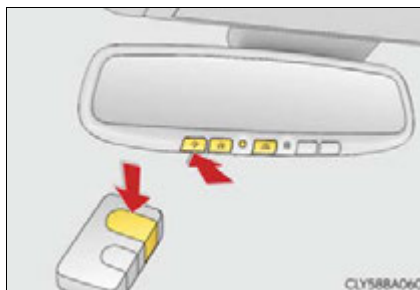

If the HomeLink[®] indicator light comes on but does not flash, the HomeLink[®] button is already programmed. Use the other buttons or follow the "Reprogramming a HomeLink[®] button" instructions. (→P. 417)

The remote control transmitter is of the rolling code type if the HomeLink[®] indicator light flashes rapidly for 2 seconds and then remains lit. If your transmitter is of the rolling code type, proceed to the heading "Programming a rolling code system".

امداد خودروفا
تلفن شبانه روزی: ۰۲۱۸۸۶۲۸۵
FarmaSOS.com

- 3** Test the HomeLink[®] operation by pressing the newly programmed button.

If a HomeLink[®] button has been programmed for a garage door, check to see if the garage door opens and closes. If the garage door does not operate, see if your remote control transmitter is of the rolling code type. Press and hold the programmed HomeLink[®] button. The remote control transmitter is of the rolling code type if the HomeLink[®] indicator light flashes rapidly for 2 seconds and then remains lit. If your transmitter is of the rolling code type, proceed to the heading "Programming a rolling code system".

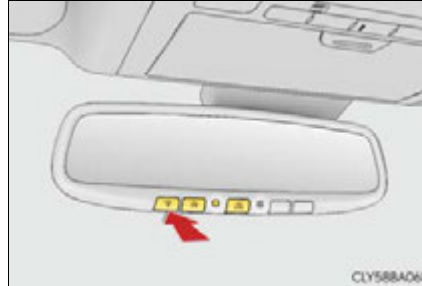

- 4** Repeat the steps above to program another device for each of the remaining HomeLink[®] buttons.

■ **Programming a Rolling Code system (for U.S.A. owners)**

If your device is Rolling Code equipped, follow the steps under the heading "Programming the HomeLink[®]" before proceeding with the steps listed below.

- 1** Locate the learn button on the ceiling mounted garage door opener motor. The exact location and color of the button may vary by brand of garage door opener motor.

Refer to the operation manual supplied with the garage door opener for the location of the learn button.

- 2** Press the learn button.

Following this step, you have 30 seconds in which to initiate step 3 below.

- 3 Press and hold the vehicle's programmed HomeLink[®] button for 2 seconds and release it. Repeat this step once again. The garage door may open.

If the garage door opens, the programming process is complete. If the door does not open, press and release the button a third time. This third press and release will complete the programming process by opening the garage door.

The ceiling mounted garage door opener motor should now recognize the HomeLink[®] signal and operate the garage door.

- 4 Repeat the steps above to program another rolling code system for any of the remaining HomeLink[®] buttons.

■ Programming an entry gate (for U.S.A. owners)/Programming all devices in the Canadian market

- 1 Place your transmitter 1 to 3 in. (25 to 75 mm) away from the surface of the HomeLink[®].

Keep the HomeLink[®] indicator light in view while programming.

- 2 Press and hold the selected HomeLink[®] button.
- 3 Repeatedly press and release (cycle) the device's remote control button for two seconds each until step 4 is completed.
- 4 When the indicator light on the HomeLink[®] compatible transceiver starts to flash rapidly, release the buttons.
- 5 Test the operation of the HomeLink[®] by pressing the newly programmed button. Check to see if the gate/device operates correctly.
- 6 Repeat the steps above to program another device for each of the remaining HomeLink[®] buttons.

■ Programming other devices

To program other devices such as home security systems, home door locks or lighting, contact your Lexus dealer for assistance.

■ Reprogramming a button

The individual HomeLink[®] buttons cannot be erased but can be reprogrammed. To reprogram a button, follow the "Reprogramming a HomeLink[®] button" instructions.

Operating HomeLink®

Press the appropriate HomeLink® button. The HomeLink® indicator light should turn on.

The HomeLink® compatible transceiver in your vehicle continues to send a signal for up to 20 seconds as long as the button is pressed.

Reprogramming a HomeLink® button

Press and hold the desired HomeLink® button. After 20 seconds, the HomeLink® indicator light will start flashing slowly. Next, while still pressing and holding the HomeLink® button, press and hold the button on the transmitter until the HomeLink® indicator light changes from a slow to a rapid flash.

Erasing the entire HomeLink® memory (all three programs)

Press and hold the 2 outside buttons for 10 seconds until the indicator light flashes.

If you sell your vehicle, be sure to erase the programs stored in the HomeLink® memory.



5

Interior features

■ Before programming

- Install a new battery in the remote control transmitter.
- The battery side of the remote control transmitter must be pointed away from the HomeLink® button.

■ Certification for the garage door opener

- ▶ For vehicles sold in the U.S.A.

FCC ID: NZLOBIHL4

FCC ID: NZLWZLHL4

FCC ID: NZLHSLMHL4

NOTE:

This device complies with part 15 of the FCC Rules. Operation is subject to the following two conditions: (1) This device may not cause harmful interference, and (2) this device must accept any interference received, including interference that may cause undesired operation.

FCC WARNING:

Changes or modifications not expressly approved by the party responsible for compliance could void the user's authority to operate the equipment.

- ▶ For vehicles sold in Canada

NOTE:

This device complies with Industry Canada licence-exempt RSS standard(s). Operation is subject to the following two conditions: (1) this device may not cause interference, and (2) this device must accept any interference, including interference that may cause undesired operation of the device.

REMARQUE:

Le présent appareil est conforme aux CNR d'Industrie Canada applicables aux appareils radio exempts de licence. L'exploitation est autorisée aux deux conditions suivantes : (1) l'appareil ne doit pas produire de brouillage, et (2) l'utilisateur de l'appareil doit accepter tout brouillage radioélectrique subi, même si le brouillage est susceptible d'en compromettre le fonctionnement.

■ When support is necessary

Visit on the web at www.homelink.com or call 1-800-355-3515.

⚠ CAUTION**■ When programming a garage door or other remote control device**

The garage door or other device may operate, so ensure people and objects are out of danger to prevent potential harm.

■ Conforming to federal safety standards

Do not use the HomeLink[®] compatible transceiver with any garage door opener or device that lacks safety stop and reverse features as required by federal safety standards.

This includes any garage door that cannot detect an obstruction object. A door or device without these features increases the risk of death or serious injury.

امداد خودرو فارما

تلفن شبانه روزی: ۰۲۱-۸۸۸۶۲۰۸۵

FarmaSOS.com

LEXUS Enform Safety Connect*

Safety Connect is a subscription-based telematics service that uses Global Positioning System (GPS) data and embedded cellular technology to provide safety and security features to subscribers. Safety Connect is supported by Lexus' designated response center, which operates 24 hours per day, 7 days per week.

Safety Connect service is available by subscription on select, telematics hardware-equipped vehicles.

By using the Safety Connect service, you are agreeing to be bound by the Telematics Subscription Service Agreement and its Terms and Conditions, as in effect and amended from time to time, a current copy of which is available at Lexus.com. All use of the Safety Connect service is subject to such then-applicable Terms and Conditions.

■ System components

- ① Microphone
- ② "SOS" button
- ③ LED light indicators



*: If equipped

■ Services

Subscribers have the following Safety Connect services available:

- Automatic Collision Notification*

Helps drivers receive necessary response from emergency service providers. (→P. 423)

*: U.S. Patent No. 7,508,298 B2

- Stolen Vehicle Location

Helps drivers in the event of vehicle theft. (→P. 424)

- Emergency Assistance Button (SOS)

Connects drivers to response-center support. (→P. 424)

- Enhanced Roadside Assistance

Provides drivers various on-road assistance. (→P. 424)

■ Subscription

After you have signed the Telematics Subscription Service Agreement and are enrolled, you can begin receiving services.

A variety of subscription terms is available for purchase. Contact your Lexus dealer, call 1-800-25-LEXUS (1-800-255-3987) or push the "SOS" button in your vehicle for further subscription details.

FarmaSOS.com

■ Safety Connect Services Information

- Phone calls using the vehicles Bluetooth® technology will not be possible during Safety Connect.
- Safety Connect is available beginning Fall 2009 on select Lexus models. Contact with the Safety Connect response center is dependent upon the telematics device being in operative condition, cellular connection availability, and GPS satellite signal reception, which can limit the ability to reach the response center or receive emergency service support. Enrollment and Telematics Subscription Service Agreement required. A variety of subscription terms is available; charges vary by subscription term selected.
- Automatic Collision Notification, Emergency Assistance and Stolen Vehicle Location will function in the United States, including Hawaii and Alaska, and in Canada, and Enhanced Roadside Assistance will function in the United States (except Hawaii) and in Canada. No Safety Connect services will function outside of the United States in countries other than Canada.
- Safety Connect services are not subject to section 255 of the Telecommunications Act and the device is not TTY compatible.

■ Languages

The Safety Connect response center will offer support in multiple languages. The Safety Connect system will offer voice prompts in English and Spanish. Please indicate your language of choice when enrolling.

■ When contacting the response center

You may be unable to contact the response center if the network is busy.

FarmaSOS.com

Safety Connect LED light Indicators

When the engine switch is turned to IGNITION ON mode, the red indicator light comes on for 2 seconds then turns off. Afterward, the green indicator light comes on, indicating that the service is active.

The following indicator light patterns indicate specific system usage conditions:

- Green indicator light on = Active service
- Green indicator light flashing = Safety Connect call in process
- Red indicator light (except at vehicle start-up) = System malfunction (contact your Lexus dealer)
- No indicator light (off) = Safety Connect service not active

Safety Connect services

■ Automatic Collision Notification

In case of either airbag deployment or severe rear-end collision, the system is designed to automatically call the response center. The responding agent receives the vehicle's location and attempts to speak with the vehicle occupants to assess the level of emergency. If the occupants are unable to communicate, the agent automatically treats the call as an emergency, contacts the nearest emergency services provider to describe the situation, and requests that assistance be sent to the location.

■ Stolen Vehicle Location

If your vehicle is stolen, Safety Connect can work with local authorities to assist them in locating and recovering the vehicle. After filing a police report, call the Safety Connect response center at 1-800-25-LEXUS (1-800-255-3987) and follow the prompts for Safety Connect to initiate this service.

In addition to assisting law enforcement with recovery of a stolen vehicle, Safety-Connect-equipped vehicle location data may, under certain circumstances, be shared with third parties to locate your vehicle. Further information is available at Lexus.com.

■ Emergency Assistance Button (“SOS”)

In the event of an emergency on the road, push the “SOS” button to reach the Safety Connect response center. The answering agent will determine your vehicle’s location, assess the emergency, and dispatch the necessary assistance required.

If you accidentally press the “SOS” button, tell the response-center agent that you are not experiencing an emergency.

■ Enhanced Roadside Assistance

Enhanced Roadside Assistance adds GPS data to the already included warranty-based Lexus roadside service.

Subscribers can press the “SOS” button to reach a Safety Connect response-center agent, who can help with a wide range of needs, such as: towing, flat tire, fuel delivery, etc. For a description of the Enhanced Roadside Assistance services and their limitations, please see the Safety Connect Terms and Conditions, which are available at Lexus.com.

Safety information for Safety Connect

Important! Read this information before using Safety Connect.

■ Exposure to radio frequency signals

The Safety Connect system installed in your vehicle is a low-power radio transmitter and receiver. It receives and also sends out radio frequency (RF) signals.

In August 1996, the Federal Communications Commission (FCC) adopted RF exposure guidelines with safety levels for mobile wireless phones. Those guidelines are consistent with the safety standards previously set by the following U.S. and international standards bodies.

- ANSI (American National Standards Institute) C95.1 [1992]
- NCRP (National Council on Radiation Protection and Measurement) Report 86 [1986]
- ICNIRP (International Commission on Non-Ionizing Radiation Protection) [1996]

Those standards were based on comprehensive and periodic evaluations of the relevant scientific literature. Over 120 scientists, engineers, and physicians from universities, and government health agencies and industries reviewed the available body of research to develop the ANSI Standard (C95.1).

The design of Safety Connect complies with the FCC guidelines in addition to those standards.

■ Certification for Lexus Enform

FCC ID: O6Y-CDMRF101

FCC ID: XOECDMRF101B

FCC ID: N7NGTM2

NOTE:

This device complies with Part 15 of the FCC Rules. Operation is subject to the following two conditions: (1) This device may not cause harmful interference, and (2) this device must accept any interference received, including interference that may cause undesired operation.

FCC WARNING:

Changes or modifications not expressly approved by the party responsible for compliance could void the user's authority to operate the equipment.

امداد خودرو فارما

تلفن شبانه روزی: ۰۲۱-۸۸۸۶۲۰۸۵

FarmaSOS.com

6-1. Maintenance and care

Cleaning and protecting
the vehicle exterior..... 428

Cleaning and protecting
the vehicle interior..... 432

6-2. Maintenance

Maintenance
requirements..... 435

General maintenance..... 438

Emission inspection and
maintenance (I/M)
programs..... 442

6-3. Do-it-yourself maintenance

Do-it-yourself service
precautions..... 443

Hood..... 446

Positioning a floor jack..... 447

Engine compartment..... 449

Tires..... 464

Tire inflation pressure..... 475

Wheels..... 478

Air conditioning filter..... 480

Electronic key battery..... 483

Checking and replacing
fuses..... 485

Headlight aim..... 489

Light bulbs..... 491

Cleaning and protecting the vehicle exterior

Perform the following to protect the vehicle and maintain it in prime condition:

- Working from top to bottom, liberally apply water to the vehicle body, wheel wells and underside of the vehicle to remove any dirt and dust.
- Wash the vehicle body using a sponge or soft cloth, such as a chamois.
- For hard-to-remove marks, use car wash soap and rinse thoroughly with water.
- Wipe away any water.
- Wax the vehicle when the waterproof coating deteriorates.
If water does not bead on a clean surface, apply wax when the vehicle body is cool.

■ Self-restoring coat

The vehicle body has a self-restoring coating that is resistant to small surface scratches caused in a car wash etc.

- The coating lasts for 5 to 8 years from when the vehicle is delivered from the plant.
- The restoration time differs depending on the depth of the scratch and outside temperature.
The restoration time may become shorter when the coating is warmed by applying warm water.
- Deep scratches caused by keys, coins, etc. cannot be restored.
- Do not use wax that contain abrasives.

■ Automatic car washes

- Fold the mirrors before washing the vehicle. Start washing from the front of the vehicle. Make sure to extend the mirrors before driving.
- Brushes used in automatic car washes may scratch the vehicle surface and harm your vehicle's paint.

■ High pressure car washes

- Do not allow the nozzles of the car wash to come within close proximity of the windows and the air suspension unit (if equipped).
- Before using the car wash, check that the fuel filler door on your vehicle is closed properly.

■ Aluminum wheels

- Remove any dirt immediately by using a neutral detergent. Do not use hard brushes or abrasive cleaners. Do not use strong or harsh chemical cleaners. Use the same mild detergent and wax as used on the paint.
- Do not use detergent on the wheels when they are hot, for example after driving for long distance in the hot weather.
- Wash detergent from the wheels immediately after use.

■ Bumpers and side moldings

Do not scrub with abrasive cleaners.

■ Front side windows water-repellent coating

- The following precautions can extend the effectiveness of the water-repellent coating.
 - Remove any dirt, etc. from the front side windows regularly.
 - Do not allow dirt and dust to accumulate on the windows for a long period. Clean the windows with a soft, damp cloth as soon as possible.
 - Do not use wax or glass cleaners that contain abrasives when cleaning the windows.
 - Do not use any metallic objects to remove condensation build up.
- When the water-repellent performance has become insufficient, the coating can be repaired. Contact your Lexus dealer.

⚠ CAUTION

■ **When washing the vehicle**

Do not apply water to the inside of the engine compartment. Doing so may cause the electrical components etc. to catch fire.

■ **When cleaning the windshield**

Set the wiper switch to off.

If the wiper switch is in "AUTO", the wipers may operate unexpectedly in the following situations, and may result in hands being caught or other serious injuries and cause damage to the wiper blades.

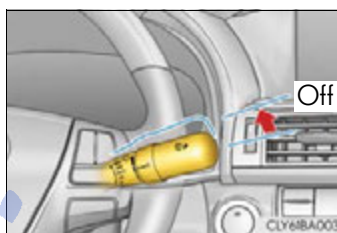

- When the upper part of the windshield where the raindrop sensor is located is touched by hand
- When a wet rag or similar is held close to the raindrop sensor
- If something bumps against the windshield
- If you directly touch the raindrop sensor body or if something bumps into the raindrop sensor

■ **Precautions regarding the exhaust pipes and rear bumper diffusers**

Exhaust gases cause the exhaust pipes and rear bumper diffusers to become quite hot.

When washing the vehicle, be careful not to touch the pipes and diffusers until they have cooled sufficiently, as touching hot exhaust pipes and rear bumper diffusers can cause burns.

■ **Precaution regarding the rear bumper with Blind Spot Monitor (if equipped)**

If the paint of the rear bumper is chipped or scratched, the system may malfunction. If this occurs, consult your Lexus dealer.

 NOTICE

■ **To prevent paint deterioration and corrosion on the body and components (aluminum wheels etc.)**

- Wash the vehicle immediately in the following cases:
 - After driving near the sea coast
 - After driving on salted roads
 - If coal tar or tree sap is present on the paint surface
 - If dead insects, insect droppings or bird droppings are present on the paint surface
 - After driving in an area contaminated with soot, oily smoke, mine dust, iron powder or chemical substances
 - If the vehicle becomes heavily soiled with dust or mud
 - If liquids such as benzene and gasoline are spilled on the paint surface
- If the paint is chipped or scratched, have it repaired immediately.
- To prevent the wheels from corroding, remove any dirt and store in a place with low humidity when storing the wheels.

■ **Cleaning the exterior lights**

- Wash carefully. Do not use organic substances or scrub with a hard brush. This may damage the surfaces of the lights.
- Do not apply wax to the surfaces of the lights. Wax may cause damage to the lenses.

■ **When using an automatic car wash**

Set the wiper switch to the off position.
If the wiper switch is in "AUTO", the wipers may operate and the wiper blades may be damaged.

■ **When using a high pressure car wash**

- When washing the vehicle, do not spray the camera or its surrounding area directly with a high pressure washer. Shock applied from high pressure water may cause the device to not operate normally.
- Do not bring the nozzle tip close to boots (rubber or resin manufactured cover), connectors or the following parts. The parts may be damaged if they come into contact with high-pressure water.

• Traction related parts	• Suspension parts
• Steering parts	• Brake parts

Cleaning and protecting the vehicle interior

The following procedures will help protect your vehicle's interior and keep it in top condition:

Protecting the vehicle interior

Remove dirt and dust using a vacuum cleaner. Wipe dirty surfaces with a cloth dampened with lukewarm water.

Cleaning the leather areas

- Remove dirt and dust using a vacuum cleaner.
- Wipe off any excess dirt and dust with a soft cloth dampened with diluted detergent.
Use a diluted water solution of approximately 5% neutral wool detergent.
- Wring out any excess water from the cloth and thoroughly wipe off all remaining traces of detergent.
- Wipe the surface with a dry, soft cloth to remove any remaining moisture. Allow the leather to dry in a shaded and ventilated area.

Cleaning the synthetic leather areas

- Remove loose dirt using a vacuum cleaner.
- Apply a mild soap solution to the synthetic leather using a sponge or soft cloth.
- Allow the solution to soak in for a few minutes. Remove the dirt and wipe off the solution with a clean, damp cloth.

■ Caring for leather areas

Lexus recommends cleaning the interior of the vehicle at least twice a year to maintain the quality of the vehicle's interior.

■ Shampooing the carpets

There are several commercial foaming-type cleaners available. Use a sponge or brush to apply the foam. Rub in overlapping circles. Do not use water. Wipe dirty surfaces and let them dry. Excellent results are obtained by keeping the carpet as dry as possible.

■ Seat belts

Clean with mild soap and lukewarm water using a cloth or sponge. Also check the belts periodically for excessive wear, fraying or cuts.

⚠ CAUTION

■ Water in the vehicle

- Do not splash or spill liquid in the vehicle.
Doing so may cause electrical components etc. to malfunction or catch fire.
- Do not get any of the SRS components or wiring in the vehicle interior wet.
(→P. 46)
An electrical malfunction may cause the airbags to deploy or not function properly, resulting in death or serious injury.

■ Cleaning the interior (especially instrument panel)

Do not use polish wax or polish cleaner. The instrument panel may reflect off the windshield, obstructing the driver's view and leading to an accident, resulting in death or serious injury.

■ Cleaning the leather areas of the instrument panel

Do not use any protective agents (coatings etc). Doing so may cause the instrument panel to reflect onto the windshield, obstructing the front view and possibly causing an accident.

 NOTICE**■ Cleaning detergents**

- Do not use the following types of detergent, as they may discolor the vehicle interior or cause streaks or damage to painted surfaces:
 - Non-seat portions: Organic substances such as benzene or gasoline, alkaline or acidic solutions, dye, and bleach
 - Seats: Alkaline or acidic solutions, such as thinner, benzene, and alcohol
- Do not use polish wax or polish cleaner. The instrument panel's or other interior part's painted surface may be damaged.

■ Preventing damage to leather surfaces

Observe the following precautions to avoid damage to and deterioration of leather surfaces:

- Remove any dust or dirt from leather surfaces immediately.
- Do not expose the vehicle to direct sunlight for extended periods of time. Park the vehicle in the shade, especially during summer.
- Do not place items made of vinyl, plastic, or containing wax on the upholstery, as they may stick to the leather surface if the vehicle interior heats up significantly.

■ Water on the floor

Do not wash the vehicle floor with water.

Vehicle systems such as the audio system may be damaged if water comes into contact with electrical components such as the audio system above or under the floor of the vehicle. Water may also cause the body to rust.

■ When cleaning the inside of the windshield (vehicles with LKA [Lane-Keeping Assist])

Be careful not to touch the camera sensor (→P. 271).
If the camera is accidentally scratched or hit, LKA may not operate properly or may cause a malfunction.

■ Cleaning the inside of the rear window

- Do not use glass cleaner to clean the rear window, as this may cause damage to the rear window defogger heater wires or antenna. Use a cloth dampened with lukewarm water to gently wipe the window clean. Wipe the window in strokes running parallel to the heater wires or antenna.
- Be careful not to scratch or damage the heater wires or antenna.

Maintenance requirements

To ensure safe and economical driving, day-to-day care and regular maintenance are essential. It is the owner's responsibility to perform regular checks. Lexus recommends the following maintenance:

General maintenance

General maintenance should be performed on a daily basis. This can be done by yourself or by a Lexus dealer.

Scheduled maintenance

Scheduled maintenance should be performed at specified intervals according to the maintenance schedule.

For details about maintenance items and schedules, refer to the "Warranty and Service Guide", "Owner's Manual Supplement" or "Scheduled Maintenance".

Do-it-yourself maintenance

You can perform some maintenance procedures by yourself.

Please be aware that do-it-yourself maintenance may affect warranty coverage.

The use of Lexus repair manuals is recommended.

For details about warranty coverage, refer to the separate "Owner's Guide", "Warranty and Service Guide", "Owner's Manual Supplement" or "Warranty Booklet".

■ Repair and replacement

It is recommended that genuine Lexus parts be used for repairs to ensure performance of each system. If non-Lexus parts are used in replacement or if a repair shop other than a Lexus dealer performs repairs, confirm the warranty coverage.

■ Resetting the message indicating maintenance is required (U.S.A. only)

After the required maintenance is performed according to the maintenance schedule, please reset the message.

To reset the message, follow the procedure described below:

- 1 Switch the display to the trip meter "A" (→P. 91) when the engine is running.
- 2 Turn the engine switch off.
- 3 While pressing the trip meter reset switch (→P. 91), turn the engine switch to the IGNITION ON mode (do not start the engine because otherwise the reset mode will be canceled).

The message shown in the illustration will appear on the display.

Continue to press and hold the switch until the trip meter displays "COMPLETE".

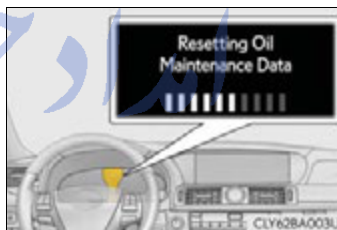

■ Allow inspection and repairs to be performed by a Lexus dealer

- Lexus technicians are well-trained specialists and are kept up to date with the latest service information. They are well informed about the operations of all systems on your vehicle.
- Keep a copy of the repair order. It proves that the maintenance that has been performed is under warranty coverage. If any problem should arise while your vehicle is under warranty, your Lexus dealer will promptly take care of it.

⚠ CAUTION**■ If your vehicle is not properly maintained**

Improper maintenance could result in serious damage to the vehicle and possible death or serious injury.

■ Handling of the battery

- Engine exhaust, some of its constituents, and a wide variety of automobile components contain or emit chemicals known to the State of California to cause cancer and birth defects and other reproductive harm. Work in a well ventilated area.
- Oils, fuels and fluids contained in vehicles as well as waste produced by component wear contain or emit chemicals known to the State of California to cause cancer and birth defects or other reproductive harm. Avoid exposure and wash any affected area immediately.
- Battery posts, terminals and related accessories contain lead and lead compounds which are known to cause brain damage. Wash your hands after handling. (→P. 460)

تلفن شبانه روزی: ۰۲۱-۸۸۶۲۰۸۵

FarmaSOS.com

General maintenance

Listed below are the general maintenance items that should be performed at the intervals specified in the “Warranty and Service Guide” or “Owner’s Manual Supplement”. It is recommended that any problem you notice should be brought to the attention of your Lexus dealer or qualified service shop for advice.

Engine compartment

Items	Check points
Battery	Check the connections. (→P. 460)
Brake fluid	Is the brake fluid at the correct level? (→P. 459)
Engine coolant	Is the engine coolant at the correct level? (→P. 457)
Engine oil	Is the engine oil at the correct level? (→P. 453)
Exhaust system	There should not be any fumes or strange sounds.
Radiator/condenser	The radiator and condenser should be free from foreign objects. (→P. 458)
Washer fluid	Is there sufficient washer fluid? (→P. 463)

Vehicle interior

Items	Check points
Accelerator pedal	<ul style="list-style-type: none"> The accelerator pedal should move smoothly (without uneven pedal effort or catching).
Automatic transmission "Park" mechanism	<ul style="list-style-type: none"> When parked on a slope and the shift lever is in P, is the vehicle securely stopped?
Brake pedal	<ul style="list-style-type: none"> Does the brake pedal move smoothly? Does the brake pedal have appropriate clearance from the floor? (→P. 558) Does the brake pedal have the correct amount of free play? (→P. 558)
Brakes	<ul style="list-style-type: none"> The vehicle should not pull to one side when the brakes are applied. The brakes should work effectively. The brake pedal should not feel spongy. The brake pedal should not get too close to the floor when the brakes are applied.

Items	Check points
Head restraints	<ul style="list-style-type: none"> Do the head restraints move smoothly and lock securely?
Indicators/buzzers	<ul style="list-style-type: none"> Do the indicators and buzzers function properly?
Lights	<ul style="list-style-type: none"> Do all the lights come on? Are the headlights aimed correctly? (→P. 489)
Parking brake	<ul style="list-style-type: none"> Moves smoothly? When parked on a slope and the parking brake is on, is the vehicle securely stopped?
Seat belts	<ul style="list-style-type: none"> Do the seat belts operate smoothly? The seat belts should not be damaged.
Seats	<ul style="list-style-type: none"> Do the seat controls operate properly?
Steering wheel	<ul style="list-style-type: none"> Does the steering wheel rotate smoothly? Does the steering wheel have the correct amount of free play? There should not be any strange sounds coming from the steering wheel.

FarmaSOS.com

Vehicle exterior

Items	Check points
Doors/trunk	<ul style="list-style-type: none"> Do the doors/trunk operate smoothly?
Engine hood	<ul style="list-style-type: none"> Does the engine hood lock system work properly?
Fluid leaks	<ul style="list-style-type: none"> There should not be any signs of fluid leakage after the vehicle has been parked.
Tires	<ul style="list-style-type: none"> Is the tire inflation pressure correct? The tires should not be damaged or excessively worn. Have the tires been rotated according to the maintenance schedule? The wheel nuts should not be loose.
Windshield wipers	<ul style="list-style-type: none"> The wiper blades should not show any signs of cracking, splitting, wear, contamination or deformation. The wiper blades should clear the windshield without streaking or skipping.

⚠ CAUTION

■ If the engine is running

Turn the engine off and ensure that there is adequate ventilation before performing maintenance checks.

Emission inspection and maintenance (I/M) programs

Some states have vehicle emission inspection programs which include OBD (On Board Diagnostics) checks. The OBD system monitors the operation of the emission control system.

If the malfunction indicator lamp comes on

The OBD system determines that a problem exists somewhere in the emission control system. Your vehicle may not pass the I/M test and may need to be repaired. Contact your Lexus dealer to service the vehicle.

Your vehicle may not pass the I/M test in the following situations:

- When the battery is disconnected or discharged
Readiness codes that are set during ordinary driving are erased. Also, depending on your driving habits, the readiness codes may not be completely set.
- When the fuel tank cap is loose
The malfunction indicator lamp comes on indicating a temporary malfunction and your vehicle may not pass the I/M test.

When the malfunction indicator lamp still remains on after several driving trips

The error code in the OBD system will not be cleared unless the vehicle is driven 40 or more times.

If your vehicle does not pass the I/M test

Contact your Lexus dealer to prepare the vehicle for re-testing.

Do-it-yourself service precautions

If you perform maintenance by yourself, be sure to follow the correct procedure as given in these sections.

Items	Parts and tools
Battery condition (→P. 460)	<ul style="list-style-type: none"> • Warm water • Baking soda • Grease • Conventional wrench (for terminal clamp bolts)
Brake fluid level (→P. 459)	<ul style="list-style-type: none"> • FMVSS No.116 DOT 3 or SAE J1703 brake fluid • Rag or paper towel • Funnel (used only for adding brake fluid)
Engine coolant level (→P. 457)	<ul style="list-style-type: none"> • "Toyota Super Long Life Coolant" or a similar high quality ethylene glycol-based non-silicate, non-amine, non-nitrite and non-borate coolant with long-life hybrid organic acid technology For the U.S.A.: "Toyota Super Long Life Coolant" is pre-mixed with 50% coolant and 50% deionized water. For Canada: "Toyota Super Long Life Coolant" is pre-mixed with 55% coolant and 45% deionized water. • Funnel (used only for adding coolant)
Engine oil level (→P. 453)	<ul style="list-style-type: none"> • "Toyota Genuine Motor Oil" or equivalent • Rag or paper towel • Funnel (used only for adding engine oil)
Fuses (→P. 485)	<ul style="list-style-type: none"> • Fuse with same amperage rating as original
Headlight aim (→P. 489)	<ul style="list-style-type: none"> • Phillips-head screwdriver

Items	Parts and tools
Radiator and condenser (→P. 458)	—
Tire inflation pressure (→P. 475)	<ul style="list-style-type: none"> • Tire pressure gauge • Compressed air source
Washer fluid (→P. 463)	<ul style="list-style-type: none"> • Water or washer fluid containing anti-freeze (for winter use) • Funnel (used only for adding water or washer fluid)

⚠ CAUTION

The engine compartment contains many mechanisms and fluids that may move suddenly, become hot, or become electrically energized. To avoid death or serious injury, observe the following precautions.

■ **When working on the engine compartment**

- Keep hands, clothing and tools away from the moving fan and engine drive belt.
- Be careful not to touch the engine, radiator, exhaust manifold, etc. right after driving as they may be hot. Oil and other fluids may also be hot.
- Do not leave anything that may burn easily, such as paper and rags, in the engine compartment.
- Do not smoke, cause sparks or expose an open flame to fuel or the battery. Fuel and battery fumes are flammable.
- Be extremely cautious when working on the battery. It contains poisonous and corrosive sulfuric acid.

■ **When working near the electric cooling fans or radiator grille**

Be sure the engine switch is off.
 With the engine switch in IGNITION ON mode, the electric cooling fans may automatically start to run if the air conditioning is on and/or the coolant temperature is high. (→P. 458)

■ **Safety glasses**

Wear safety glasses to prevent flying or falling material, fluid spray, etc. from getting in your eyes.

 NOTICE

■ If you remove the air cleaner filter

Driving with the air cleaner filter removed may cause excessive engine wear due to dirt in the air.

امداد خودرو فارما

تلفن شبانه روزی: ۰۲۱-۸۸۸۶۲۰۸۵

FarmaSOS.com

Hood

Release the lock from the inside of the vehicle to open the hood.

- 1 Pull the hood lock release lever.

The hood will pop up slightly.



- 2 Pull up the auxiliary catch lever and lift the hood.

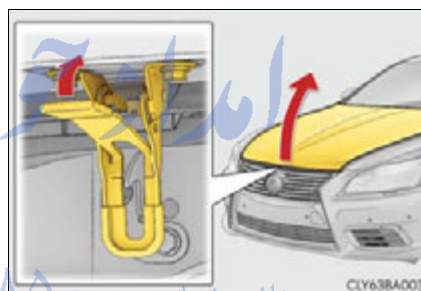

⚠ CAUTION

■ Pre-driving check

Check that the hood is fully closed and locked.
If the hood is not locked properly, it may open while the vehicle is in motion and cause an accident, which may result in death or serious injury.

Positioning a floor jack

When raising your vehicle with a floor jack, position the jack correctly. Improper placement may damage your vehicle or cause injury.

◆ Front

▶ 2WD models

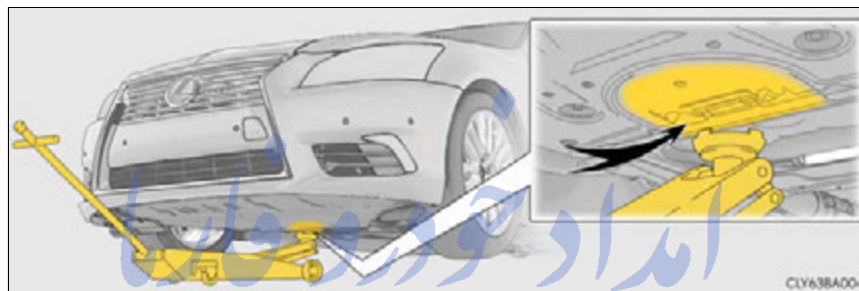

▶ AWD models

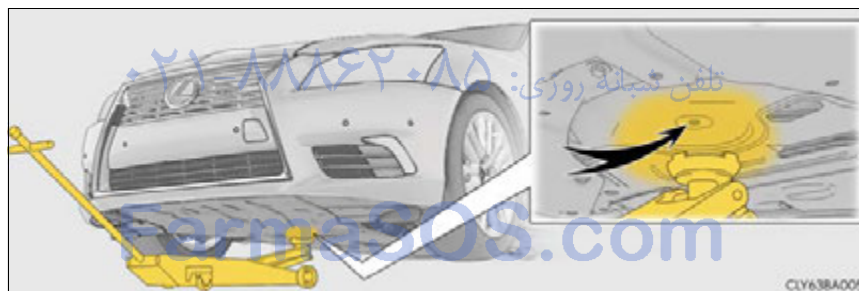

◆ Rear

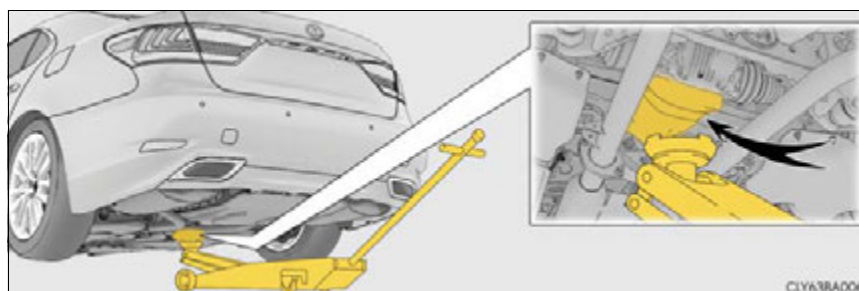

⚠ CAUTION

■ **When raising your vehicle**

Make sure to observe the following precautions to reduce the possibility of death or serious injury:

- Lift up the vehicle using a floor jack such as the one shown in the illustration.



- When using a floor jack, follow the instructions of the manual provided with the jack.
- Do not use the jack that was supplied with your vehicle.
- Do not put any part of your body underneath the vehicle when it is supported only by the floor jack.
- Always use floor jack and/or automotive jack stands on a solid, flat, level surface.
- Do not start the engine while the vehicle is supported by the floor jack.
- Stop the vehicle on level, firm ground, firmly set the parking brake and shift the shift lever to P.
- Make sure to set the floor jack properly at the jack point.
Raising the vehicle with an improperly positioned floor jack will damage the vehicle and may cause the vehicle to fall off the floor jack.
- Do not raise the vehicle while someone is in the vehicle.
- When raising the vehicle, do not place any object on top of or underneath the floor jack.
- Vehicles with electronically modulated air suspension:
Be sure to turn off the height control and stop the engine. Otherwise, the vehicle height may change in the automatic leveling function. (→P. 284)

Engine compartment

► 2WD models

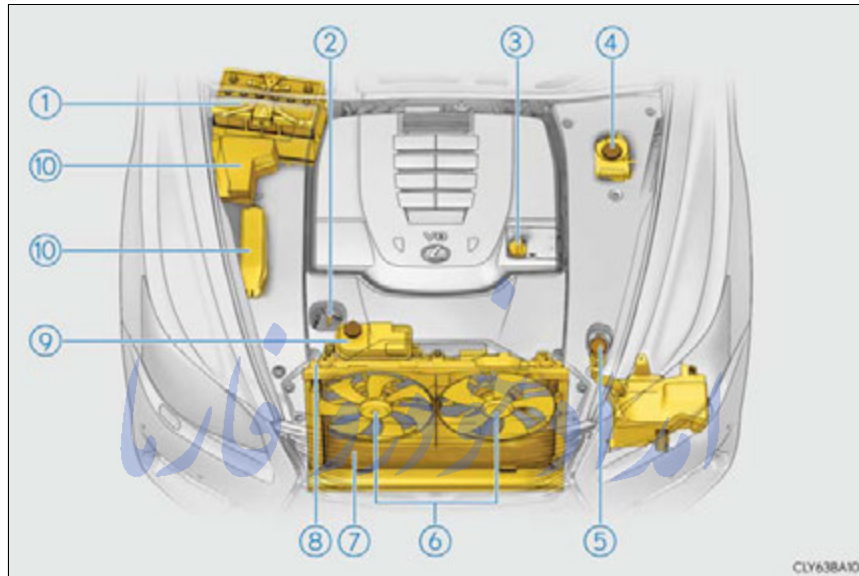

- | | |
|---------------------------------------|----------------------------|
| ① Battery (→P. 460) | ⑥ Electric cooling fans |
| ② Engine oil level dipstick (→P. 453) | ⑦ Condenser (→P. 458) |
| ③ Engine oil filler cap (→P. 454) | ⑧ Radiator (→P. 458) |
| ④ Brake fluid reservoir (→P. 459) | ⑨ Engine coolant reservoir |
| ⑤ Washer fluid tank (→P. 463) | ⑩ Fuse boxes (→P. 485) |

► AWD models

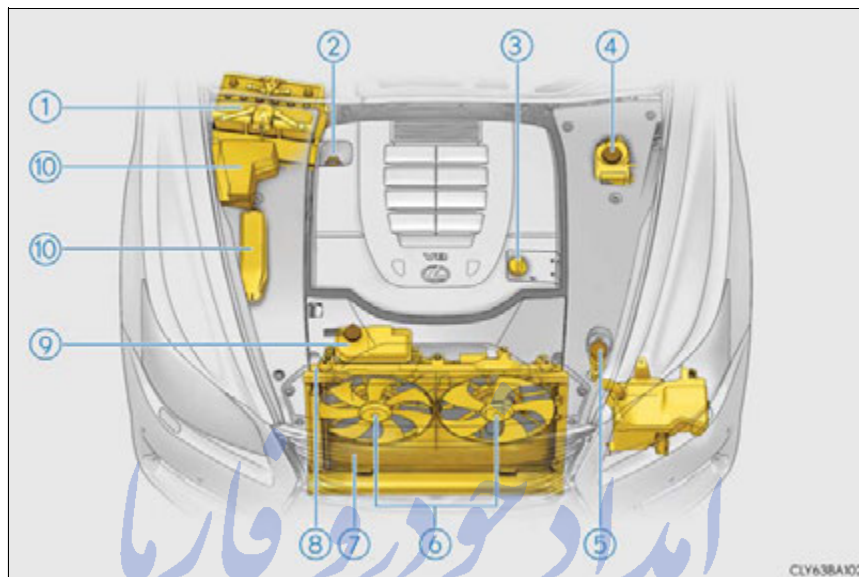

- | | | |
|-----------------------------------|-----------|----------------------------|
| ① Battery | (→P. 460) | ⑥ Electric cooling fans |
| ② Engine oil level dipstick | (→P. 453) | ⑦ Condenser (→P. 458) |
| ③ Engine oil filler cap (→P. 454) | | ⑧ Radiator (→P. 458) |
| ④ Brake fluid reservoir | (→P. 457) | ⑨ Engine coolant reservoir |
| | (→P. 459) | ⑩ Fuse boxes (→P. 485) |
| ⑤ Washer fluid tank (→P. 463) | | |

Engine compartment cover

■ Removing the engine compartment cover

▶ Outside



▶ Front

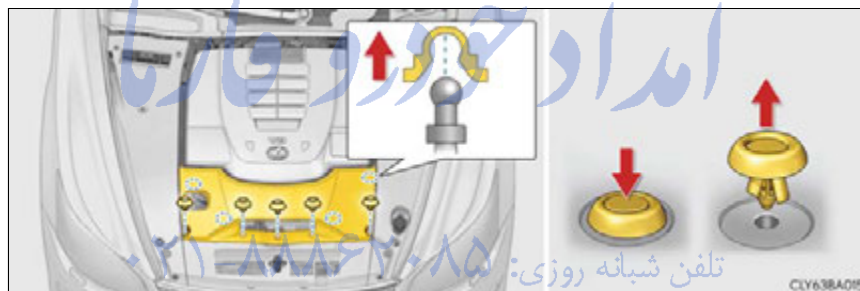

■ Installing the clips

- ① Push up center portion
- ② Insert
- ③ Press



⚠ NOTICE

■ Checking the engine compartment cover after installation

Make sure that the cover is securely installed in its original position.

Battery cover

■ Removing the battery cover

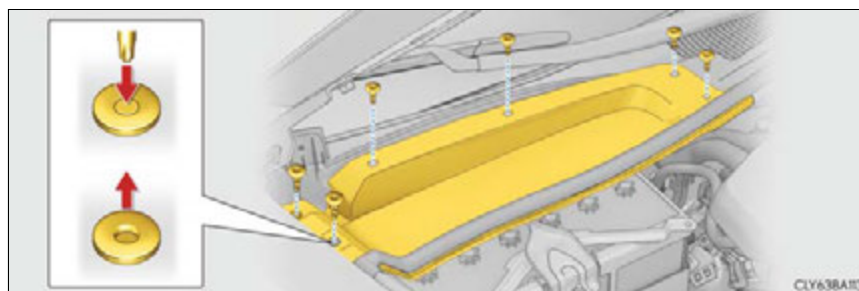

■ Installing the clips

▶ Type A

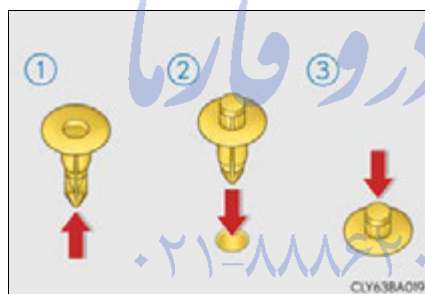

▶ Type B



- ① Push up center portion
- ② Insert
- ③ Press

⚠ NOTICE

■ When installing the battery cover

Securely install the cover over the battery. Failure to do so may cause water to enter the engine compartment when it rains or the vehicle is washed, resulting in a malfunction

Engine oil

With the engine at operating temperature and turned off, check the oil level on the dipstick.

■ Checking the engine oil

- 1 Park the vehicle on level ground. After warming up the engine and turning it off, wait more than 5 minutes for the oil to drain back into the bottom of the engine.
- 2 Holding a rag under the end, pull the dipstick out.
 - ▶ 2WD models
 - ▶ AWD models

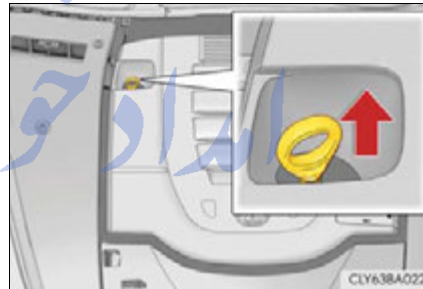
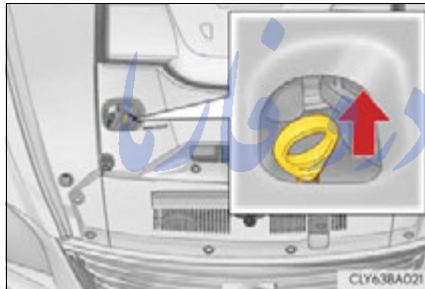

- 3 Wipe the dipstick clean.
- 4 Reinsert the dipstick fully.
- 5 Holding a rag under the end, pull the dipstick out and check the oil level.

- ① Low
- ② Normal
- ③ Excessive

The shape of the dipstick may differ depending on the type of vehicle or engine.

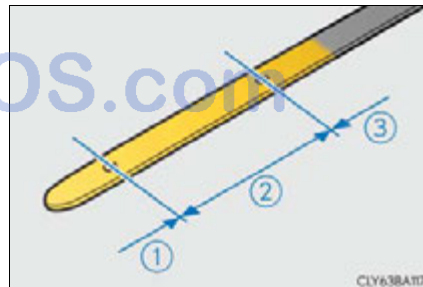

- 6 Wipe the dipstick and reinsert it fully.

■ Adding engine oil

If the oil level is below or near the low level mark, add engine oil of the same type as that already in the engine.

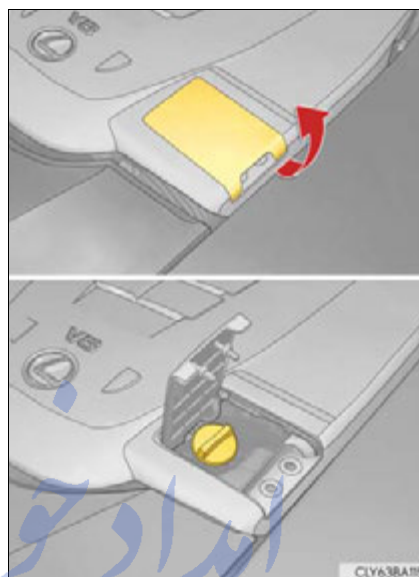

Make sure to check the oil type and prepare the items needed before adding oil.

Engine oil selection	→P.554
Oil quantity (Low → Full)	1.6 qt. (1.5 L, 1.3 Imp. qt.)
Items	Clean funnel

- 1** Remove the oil filler cap by turning it counterclockwise.
- 2** Add engine oil slowly, checking the dipstick.
- 3** Install the oil filler cap by turning it clockwise.

■ Engine oil consumption

A certain amount of engine oil will be consumed while driving. In the following situations, oil consumption may increase, and engine oil may need to be refilled in between oil maintenance intervals.

- When the engine is new, for example directly after purchasing the vehicle or after replacing the engine
- If low quality oil or oil of an inappropriate viscosity is used
- When driving at high engine speeds or with a heavy load, when driving while accelerating or decelerating frequently
- When leaving the engine idling for a long time, or when driving frequently through heavy traffic

■ After changing the engine oil

The engine oil maintenance data should be reset. Perform the following procedures:

- 1 Switch the display to the trip meter "B" (→P. 91) when the engine is running.
- 2 Turn the engine switch off.
- 3 While pressing the trip meter reset switch (→P. 91), turn the engine switch to the IGNITION ON mode (do not start the engine because otherwise the reset mode will be canceled).

The message shown in the illustration will appear on the display.

Continue to press and hold the switch until the trip meter displays "COMPLETE".



 CAUTION

■ Used engine oil

- Used engine oil contains potentially harmful contaminants which may cause skin disorders such as inflammation and skin cancer, so care should be taken to avoid prolonged and repeated contact. To remove used engine oil from your skin, wash thoroughly with soap and water.
- Dispose of used oil and filters only in a safe and acceptable manner. Do not dispose of used oil and filters in household trash, in sewers or onto the ground. Call your Lexus dealer, service station or auto parts store for information concerning recycling or disposal.
- Do not leave used engine oil within the reach of children.

 NOTICE

■ To prevent serious engine damage

Check the oil level on a regular basis.

■ When replacing the engine oil

- Be careful not to spill engine oil on the vehicle components.
- Avoid overfilling, or the engine could be damaged.
- Check the oil level on the dipstick every time you refill the vehicle.
- Be sure the engine oil filler cap is properly tightened.

FarmaSOS.com

Engine coolant

The coolant level is satisfactory if it is between the “FULL” and “LOW” lines on the reservoir when the engine is cold.

- ① Reservoir cap
- ② “FULL” line
- ③ “LOW” line

If the level is on or below the “LOW” line, add coolant up to the “FULL” line.
(→P. 543)

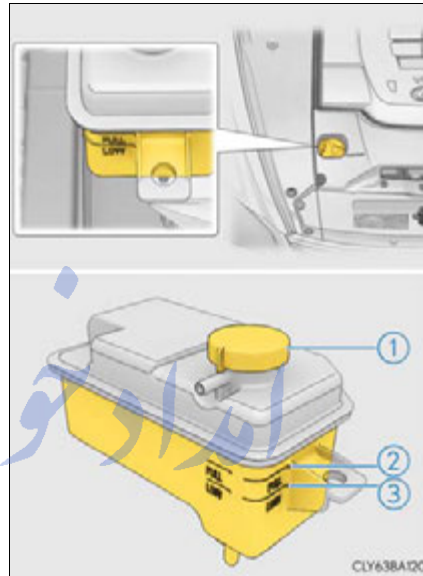

6

Maintenance and care

■ Coolant selection

Only use “Toyota Super Long Life Coolant” or a similar high quality ethylene glycol based non-silicate, non-amine, non-nitrite, and non-borate coolant with long-life hybrid organic acid technology.

U.S.A.:

“Toyota Super Long Life Coolant” is a mixture of 50% coolant and 50% deionized water. (Minimum temperature: -31°F [-35°C])

Canada:

“Toyota Super Long Life Coolant” is a mixture of 55% coolant and 45% deionized water. (Minimum temperature: -44°F [-42°C])

For more details about engine coolant, contact your Lexus dealer.

■ If the coolant level drops within a short time of replenishing

Visually check the radiator, hoses, engine coolant reservoir caps, drain cock and water pump.

If you cannot find a leak, have your Lexus dealer test the cap and check for leaks in the cooling system.

⚠ CAUTION**■ When the engine is hot**

Do not remove the engine coolant reservoir cap. The cooling system may be under pressure and may spray hot coolant if the cap is removed, causing serious injuries, such as burns.

⚠ NOTICE**■ When adding coolant**

Coolant is neither plain water nor straight antifreeze. The correct mixture of water and antifreeze must be used to provide proper lubrication, corrosion protection and cooling. Be sure to read the antifreeze or coolant label.

■ If you spill coolant

Be sure to wash it off with water to prevent it from damaging parts or paint.

Radiator and condenser

Check the radiator and condenser and clear away any foreign objects. If either of the above parts is extremely dirty or you are not sure of their condition, have your vehicle inspected by your Lexus dealer.

⚠ CAUTION**■ When the engine is hot**

Do not touch the radiator or condenser as they may be hot and cause serious injuries, such as burns.

Brake fluid

■ Checking fluid level

The brake fluid level should be between the "MAX" and "MIN" lines on the tank.



■ Adding fluid

Make sure to check the fluid type and prepare the necessary item.

Fluid type	FMVSS No.116 DOT 3 or SAE J1703 brake fluid
Items	Clean funnel

■ Brake fluid can absorb moisture from the air

Excess moisture in the brake fluid can cause a dangerous loss of braking efficiency. Use only newly opened brake fluid.

⚠ CAUTION

■ When filling the reservoir

Take care as brake fluid can harm your hands and eyes and damage painted surfaces.

If fluid gets on your hands or in your eyes, flush the affected area with clean water immediately.

If you still experience discomfort, see a doctor.

⚠ NOTICE

■ If the fluid level is low or high

It is normal for the brake fluid level to go down slightly as the brake pads wear out or when the fluid level in the accumulator is high.

If the reservoir needs frequent refilling, there may be a serious problem.

Battery

Check the battery as follows.

■ Removing the battery cover

→P. 452

■ Battery exterior

Make sure that the battery terminals are not corroded and that there are no loose connections, cracks, or loose clamps.

- ① Terminals
- ② Hold-down clamp

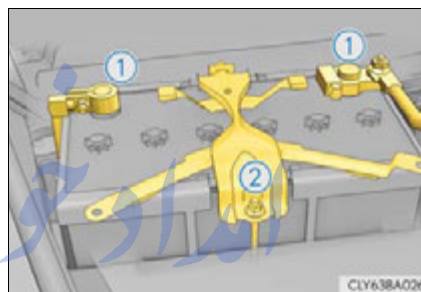

■ Before recharging

When recharging, the battery produces hydrogen gas which is flammable and explosive. Therefore, observe the following before recharging:

- If recharging with the battery installed on the vehicle, be sure to disconnect the ground cable.
- Make sure the power switch on the charger is off when connecting and disconnecting the charger cables to the battery.

■ After recharging/reconnecting the battery

The engine may not start. Follow the procedure below to initialize the system.

- 1 Shift the shift lever to P.
- 2 Open and close any of the doors.
- 3 Restart the engine. (If the engine does not start first time, repeat the procedure.)

If the engine will not start even after multiple attempts at the above method, contact your Lexus dealer.

⚠ CAUTION**■ Chemicals in the battery**

Batteries contain poisonous and corrosive sulfuric acid and may produce hydrogen gas which is flammable and explosive. To reduce the risk of death or serious injury, take the following precautions while working on or near the battery:

- Do not cause sparks by touching the battery terminals with tools.
- Do not smoke or light a match near the battery.
- Avoid contact with eyes, skin and clothes.
- Never inhale or swallow electrolyte.
- Wear protective safety glasses when working near the battery.
- Keep children away from the battery.

■ Where to safely charge the battery

Always charge the battery in an open area. Do not charge the battery in a garage or closed room where there is insufficient ventilation.

■ How to recharge the battery

Only perform a slow charge (5 A or less). The battery may explode if charged at a quicker rate.

■ Emergency measures regarding electrolyte

- If electrolyte gets in your eyes
Flush your eyes with clean water for at least 15 minutes and get immediate medical attention. If possible, continue to apply water with a sponge or cloth while traveling to the nearest medical facility.
- If electrolyte gets on your skin
Wash the affected area thoroughly. If you feel pain or burning, get medical attention immediately.
- If electrolyte gets on your clothes
It can soak through clothing on to your skin. Immediately take off the clothing and follow the procedure above if necessary.
- If you accidentally swallow electrolyte
Drink a large quantity of water or milk. Get emergency medical attention immediately.

 NOTICE**■ When recharging the battery**

Never recharge the battery while the engine is running. Also, be sure all accessories are turned off.

■ When replacing the battery

Replace the battery with a battery of the same size.

Installing a battery of a different size will prevent the cover from being properly installed over the battery. This may cause water to enter the engine compartment when it rains or the vehicle is washed, resulting in a malfunction.

For more information about replacing the battery, contact your Lexus dealer.

امداد خودرو فارما

تلفن شبانه روزی: ۰۲۱-۸۸۸۶۲۰۸۵

FarmaSOS.com

Washer fluid

If any washer does not work or the warning message appears on the multi-information display, the washer tank may be empty. Add washer fluid.



⚠ CAUTION

■ When adding washer fluid

Do not add washer fluid when the engine is hot or running as washer fluid contains alcohol and may catch fire if spilled on the engine etc.

⚠ NOTICE

■ Do not use any fluid other than washer fluid

Do not use soapy water or engine antifreeze instead of washer fluid. Doing so may cause streaking on the vehicle's painted surfaces.

■ Diluting washer fluid

Dilute washer fluid with water as necessary.

Refer to the freezing temperatures listed on the label of the washer fluid bottle.

Tires

Replace or rotate tires in accordance with maintenance schedules and treadwear.

Checking tires

Check if the treadwear indicators are showing on the tires. Also check the tires for uneven wear, such as excessive wear on one side of the tread.

Check the spare tire condition and pressure if not rotated.

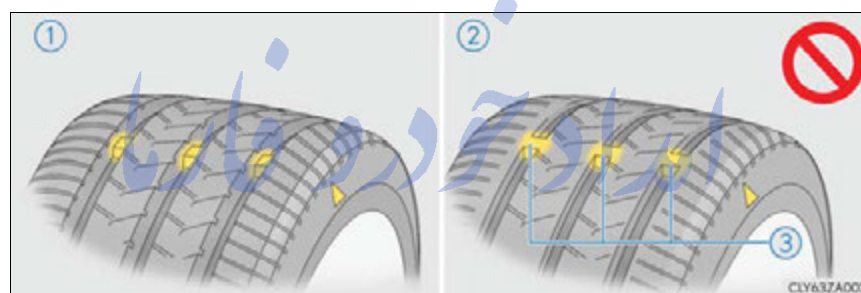

- ① New tread
- ② Worn tread
- ③ Treadwear indicator

The location of treadwear indicators is shown by a "TWI" or "Δ" mark, etc., molded into the sidewall of each tire.

Replace the tires if the treadwear indicators are showing on a tire.

Tire rotation

Rotate the tires in the order shown.

▶ Vehicles with a spare tire

▶ Vehicles with run-flat tires

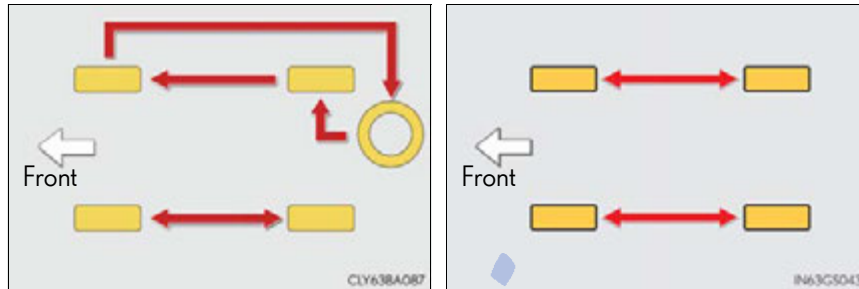

To equalize tire wear and extend tire life, Lexus recommends that tire rotation is carried out at the same interval as tire inspection.

Do not fail to initialize the tire pressure warning system after tire rotation.

تلفن شبانه روزی: ۰۲۱-۸۸۸۶۲۰۸۵

FarmaSOS.com

Tire pressure warning system

Your vehicle is equipped with a tire pressure warning system that uses tire pressure warning valves and transmitters to detect low tire inflation pressure before serious problems arise.

- If the tire pressure drops below a predetermined level, the driver is warned by a screen display and a warning light. (→P. 508, 514)
- The tire pressure detected by the tire pressure warning system can be displayed on the multi-information display. (→P. 97)



◆ Installing tire pressure warning valves and transmitters

When replacing tires or wheels, tire pressure warning valves and transmitters must also be installed.

When new tire pressure warning valves and transmitters are installed, new ID codes must be registered in the tire pressure warning computer and the tire pressure warning system must be initialized. Have tire pressure warning valve and transmitter ID codes registered by your Lexus dealer. (→P. 468)

◆ Initializing the tire pressure warning system

- The tire pressure warning system must be initialized in the following circumstances:

- When rotating the tires.
- When the tire inflation pressure is changed such as when changing traveling speed. (→P. 559)

When the tire pressure warning system is initialized, the current tire inflation pressure is set as the benchmark pressure.

■ How to initialize the tire pressure warning system

- 1** Park the vehicle in a safe place and turn the engine switch off.

Initialization cannot be performed while the vehicle is moving.

- 2** Adjust the tire inflation pressure to the specified cold tire inflation pressure level. (→P. 559)

Make sure to adjust the tire pressure to the specified cold tire inflation pressure level. The tire pressure warning system will operate based on this pressure level.

- 3** Turn the engine switch to IGNITION ON mode.

- 4** Press and hold the tire pressure warning reset switch until the tire pressure warning light blinks slowly 3 times.



- 5** Wait for a few minutes with the engine switch in IGNITION ON mode and then turn the engine switch off.

◆ Registering ID codes

The tire pressure warning valve and transmitter is equipped with a unique ID code. When replacing a tire pressure warning valve and transmitter, it is necessary to register the ID code. Have the ID code registered by your Lexus dealer.

■ When to replace your vehicle's tires

Tires should be replaced if:

- The treadwear indicators are showing on a tire.
- You have tire damage such as cuts, splits, cracks deep enough to expose the fabric, and bulges indicating internal damage
- A tire goes flat repeatedly or cannot be properly repaired due to the size or location of a cut or other damage

If you are not sure, consult with your Lexus dealer.

■ Replacing tires and wheels

If the ID code of the tire pressure warning valve and transmitter is not registered, the tire pressure warning system will not work properly. After driving for about 20 minutes, the tire pressure warning light blinks for 1 minute and stays on to indicate a system malfunction.

■ Tire life

Any tire over 6 years old must be checked by a qualified technician even if it has seldom or never been used or damage is not obvious.

■ Routine tire inflation pressure checks

The tire pressure warning system does not replace routine tire inflation pressure checks. Make sure to check tire inflation pressure as part of your routine of daily vehicle checks.

■ When rotating the tires

Make sure that the engine switch is off. If the tires are rotated while the engine switch is in IGNITION ON mode, the tire position information will not be updated.

If this accidentally occurs, either turn the engine switch to off and then to IGNITION ON mode, or initialize the system after checking that the tire pressure is properly adjusted.

■ Maximum load of tire

Check that the maximum load of the replacement tire is greater than 1/2 of the Gross Axle Weight Ratings (GAWR) of either the front axle or the rear axle, whichever is greater.

For the GAWR, see the Certification Label.
For the maximum load of the tire, see the load limit at maximum cold tire inflation pressure mentioned on the sidewall of the tire.
(→P. 566)

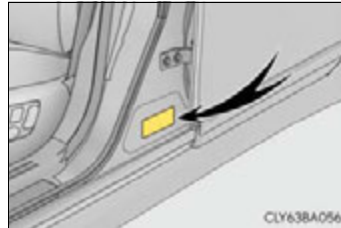

■ Tire types

● Summer tires

Summer tires are high-speed performance tires best suited to highway driving under dry conditions. Since summer tires do not have the same traction performance as snow tires, summer tires are inadequate for driving on snow-covered or icy roads. For driving on snow-covered roads or icy roads, the use of snow tires is recommended. When installing snow tires, be sure to replace all four tires.

● All season tires

All season tires are designed to provide better traction in snow and to be adequate for driving in most winter conditions as well as for use year-round. All season tires, however, do not have adequate traction performance compared with snow tires in heavy or loose snow. Also, all season tires fall short in acceleration and handling performance compared with summer tires in highway driving.

● Snow tires

For driving on snow-covered roads or icy roads, we recommend using snow tires. If you need snow tires, select tires of the same size, construction and load capacity as the originally installed tires. Since your vehicle has radial tires as original equipment, make sure your snow tires also have radial construction. Do not install studed tires without first checking local regulations for possible restrictions. Snow tires should be installed on all wheels. (→P. 321)

■ **If the tread on snow tires wears down below 0.16 in. (4 mm)**

The effectiveness of the tires as snow tires is lost.

■ **Situations in which the tire pressure warning system may not operate properly**

- In the following cases, the tire pressure warning system may not operate properly.
 - If non-genuine Lexus wheels are used.
 - A tire has been replaced with a tire that is not an OE (Original Equipment) tire.
 - A tire has been replaced with a tire that is not of the specified size.
 - Tire chains etc. are equipped.
 - An auxiliary-supported run-flat tire is equipped.
 - If a window tint that affects the radio wave signals is installed.
 - If there is a lot of snow or ice on the vehicle, particularly around the wheels or wheel housings.
 - If the tire inflation pressure is extremely higher than the specified level.
 - If the spare tire is in a location subject to poor radio wave signal reception.*
 - If a large metallic object which can interfere with signal reception is put in the trunk.*
 - If tires not equipped with tire pressure warning valves and transmitters are used.
 - If the ID code on the tire pressure warning valves and transmitters is not registered in the tire pressure warning computer.

*: Vehicles with a spare tire

- Performance may be affected in the following situations.
 - Near a TV tower, electric power plant, gas station, radio station, large display, airport or other facility that generates strong radio waves or electrical noise
 - When carrying a portable radio, cellular phone, cordless phone or other wireless communication device

If tire position information is not correctly displayed due to the radio wave conditions, the display may be corrected by driving and changing the radio wave conditions.

- When the vehicle is parked, the time taken for the warning to start or go off could be extended.
- When tire inflation pressure declines rapidly for example when a tire has burst, the warning may not function.

■ The initialization operation

- Make sure to carry out initialization after adjusting the tire inflation pressure. Also, make sure the tires are cold before carrying out initialization or tire inflation pressure adjustment.
- If you have accidentally turned the engine switch off during initialization, it is not necessary to press the reset switch again as initialization will restart automatically when the engine switch has been turned to IGNITION ON mode for the next time.
- If you accidentally press the reset switch when initialization is not necessary, adjust the tire inflation pressure to the specified level when the tires are cold, and conduct initialization again.

■ When initialization of the tire pressure warning system has failed

Initialization can be completed in a few minutes. However, in the following cases, the settings have not been recorded and the system will not operate properly. If repeated attempts to record tire inflation pressure settings are unsuccessful, have the vehicle inspected by your Lexus dealer.

- When operating the tire pressure warning reset switch, the tire pressure warning light does not blink 3 times.
- After carrying out the initialization procedure, the tire pressure warning light blinks for 1 minute then stays on after driving for 20 minutes.

تلفن شبانه روزی: ۰۲۱-۸۸۶۲۰۸۵

FarmaSOS.com

■ Tire pressure warning system certification

- ▶ For vehicles sold in the U.S.A.

FCC ID: PAXPMVC010

FCC ID: HYQ13BDS

FCC ID: HYQ22AAA

NOTE:

This device complies with part 15 of the FCC Rules. Operation is subject to the following two conditions: (1) This device may not cause harmful interference, and (2) this device must accept any interference received, including interference that may cause undesired operation.

FCC WARNING:

Changes or modifications not expressly approved by the party responsible for compliance could void the user's authority to operate the equipment.

- ▶ For vehicles sold in Canada

Transmitter:

NOTE:

Operation is subject to the following two conditions: (1) this device may not cause interference, and (2) this device must accept any interference, including interference that may cause undesired operation of the device.

Initiator:

NOTE:

This device complies with Industry Canada's licence-exempt RSSs. Operation is subject to the following two conditions:

- (1) This device may not cause interference; and
- (2) This device must accept any interference, including interference that may cause undesired operation of the device.

⚠ CAUTION

■ When inspecting or replacing tires

Observe the following precautions to prevent accidents. Failure to do so may cause damage to parts of the drive train as well as dangerous handling characteristics, which may lead to an accident resulting in death or serious injury.

- Do not mix tires of different makes, models or tread patterns.
Also, do not mix tires of remarkably different treadwear.
- Do not use tire sizes other than those recommended by Lexus.
- Do not mix differently constructed tires (radial, bias-belted or bias-ply tires).
- Do not mix summer, all season and snow tires.
- Do not use tires that have been used on another vehicle.
Do not use tires if you do not know how they were used previously.

■ Using tires of a different size

Do not use tires of a different size from those equipped when the vehicle was new, as the front tire steering angle setting is designed for the original tire size. It is dangerous to use an incorrect wheel and tire combination as this may result in reduced vehicle stability.

■ When initializing the tire pressure warning system

Do not operate the tire pressure warning reset switch without first adjusting the tire inflation pressure to the specified level. Otherwise, the tire pressure warning light may not come on even if the tire inflation pressure is low, or it may come on when the tire inflation pressure is actually normal.

■ Caution regarding interference with electronic devices

- People with implantable cardiac pacemakers, cardiac resynchronization therapy-pacemakers or implantable cardioverter defibrillators should not come within 17.7 in. (450 mm) of the tire pressure warning system initiators. The radio waves may affect the operation of such devices.

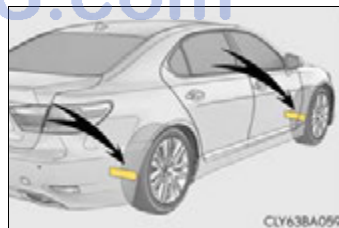

- Users of any electrical medical device other than implantable cardiac pacemakers, cardiac resynchronization therapy-pacemakers or implantable cardioverter defibrillators should consult the manufacturer of the device for information about its operation under the influence of radio waves.
Radio waves could have unexpected effects on the operation of such medical devices.

 NOTICE**■ Repairing or replacing tires, wheels, tire pressure warning valves, transmitters and tire valve caps**

- When removing or fitting the wheels, tires or the tire pressure warning valves and transmitters, contact your Lexus dealer as the tire pressure warning valves and transmitters may be damaged if not handled correctly.
- Make sure to install the tire valve caps. If the tire valve caps are not installed, water could enter the tire pressure warning valves and the tire pressure warning valves could be bound.
- When replacing tire valve caps, do not use tire valve caps other than those specified. The cap may become stuck.

■ To avoid damage to the tire pressure warning valves and transmitters

When a tire is repaired with liquid sealants, the tire pressure warning valve and transmitter may not operate properly. If a liquid sealant is used, contact your Lexus dealer or other qualified service shop as soon as possible. Make sure to replace the tire pressure warning valve and transmitter when replacing the tire. (→P. 466)

■ Driving on rough roads

Take particular care when driving on roads with loose surfaces or potholes. These conditions may cause losses in tire inflation pressure, reducing the cushioning ability of the tires. In addition, driving on rough roads may cause damage to the tires themselves, as well as the vehicle's wheels and body.

■ If tire inflation pressure of each tire becomes low while driving

Do not continue driving, or your tires and/or wheels may be ruined.

FarmaSOS.com

Tire inflation pressure

Tire inflation pressure

The recommended cold tire inflation pressure and tire size are displayed on the tire and loading information label. (→P. 559)



درو فارما

تلفن شبانه روزی: ۰۲۱-۸۸۸۶۲۰۸۵

FarmaSOS.com

6

Maintenance and care

Inspection and adjustment procedure

- ① Tire valve
- ② Tire pressure gauge

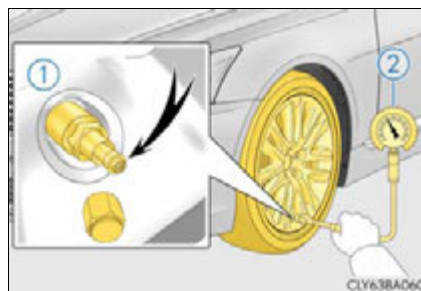

- 1 Remove the tire valve cap.
- 2 Press the tip of the tire pressure gauge onto the tire valve.
- 3 Read the pressure using the gauge gradations.
- 4 If the tire inflation pressure is not at the recommended level, adjust the pressure.
If you add too much air, press the center of the valve to deflate.
- 5 After completing the tire inflation pressure measurement and adjustment, apply soapy water to the valve and check for leakage.
- 6 Put the tire valve cap back on.

■ Tire inflation pressure check interval

You should check tire inflation pressure every two weeks, or at least once a month. Do not forget to check the spare.

■ Effects of incorrect tire inflation pressure

Driving with incorrect tire inflation pressure may result in the following:

- Reduced fuel economy
- Reduced driving comfort and poor handling
- Reduced tire life due to wear
- Reduced safety
- Damage to the drive train

If a tire needs frequent inflating, have it checked by your Lexus dealer.

■ Instructions for checking tire inflation pressure

When checking tire inflation pressure, observe the following:

- Check only when the tires are cold.
If your vehicle has been parked for at least 3 hours or has not been driven for more than 1 mile or 1.5 km, you will get an accurate cold tire inflation pressure reading.
- Always use a tire pressure gauge.
It is difficult to judge if a tire is properly inflated based only on its appearance.
- It is normal for the tire inflation pressure to be higher after driving as heat is generated in the tire. Do not reduce tire inflation pressure after driving.
- Never exceed the vehicle capacity weight.
Passengers and luggage weight should be placed so that the vehicle is balanced.

⚠ CAUTION

■ Proper inflation is critical to save tire performance

Keep your tires properly inflated.

If the tires are not properly inflated, the following conditions may occur which could lead to an accident resulting in death or serious injury:

- Excessive wear
- Uneven wear
- Poor handling
- Possibility of blowouts resulting from overheated tires
- Air leaking from between tire and wheel
- Wheel deformation and/or tire damage
- Greater possibility of tire damage while driving (due to road hazards, expansion joints, sharp edges in the road, etc.)

⚠ NOTICE

■ When inspecting and adjusting tire inflation pressure

Be sure to put the tire valve caps back on.

If a valve cap is not installed, dirt or moisture may get into the valve and cause an air leak, resulting in decreased tire inflation pressure.

Wheels

If a wheel is bent, cracked or heavily corroded, it should be replaced. Otherwise, the tire may separate from the wheel or cause a loss of handling control.

Wheel selection

When replacing wheels, care should be taken to ensure that they are equivalent to those removed in load capacity, diameter, rim width and inset*.

Replacement wheels are available at your Lexus dealer.

*: Conventionally referred to as "offset".

Lexus does not recommend using the following:

- Wheels of different sizes or types
- Used wheels
- Bent wheels that have been straightened

Aluminum wheel precautions

- Use only Lexus wheel nuts and wheel nut wrenches designed for use with your aluminum wheels.
- When rotating, repairing or changing your tires, check that the wheel nuts are still tight after driving 1000 miles (1600 km).
- Be careful not to damage the aluminum wheels when using tire chains.
- Use only Lexus genuine balance weights or equivalent and a plastic or rubber hammer when balancing your wheels.

■ When replacing wheels

The wheels of your vehicle are equipped with tire pressure warning valves and transmitters that allow the tire pressure warning system to provide advance warning in the event of a loss in tire inflation pressure. Whenever wheels are replaced, tire pressure warning valves and transmitters must be installed. (→P. 466)

⚠ CAUTION

■ When replacing wheels

- Do not use wheels that are a different size from those recommended in the Owner's Manual, as this may result in a loss of handling control.
- Never use an inner tube in a leaking wheel which is designed for a tubeless tire. Doing so may result in an accident, causing death or serious injury.

⚠ NOTICE

■ Replacing tire pressure warning valves and transmitters

- Because tire repair or replacement may affect the tire pressure warning valves and transmitters, make sure to have tires serviced by your Lexus dealer or other qualified service shop. In addition, make sure to purchase your tire pressure warning valves and transmitters at your Lexus dealer.
- Ensure that only genuine Lexus wheels are used on your vehicle. Tire pressure warning valves and transmitters may not work properly with non-genuine wheels.

Air conditioning filter

The air conditioning filter must be changed regularly to maintain air conditioning efficiency.

Removal method

■ Front air conditioning filter

- 1 Set the air conditioning system to recirculated air mode. (→P. 343)
The air conditioning filter case cannot be removed with the system in outside air mode.
- 2 Turn the engine switch off.
- 3 Open the glove box. Remove the partition. (→P. 367)
- 4 Remove the filter cover.

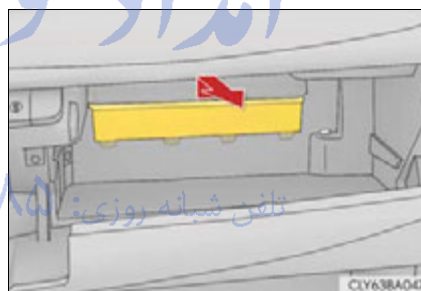

- 5 Remove the filter case.

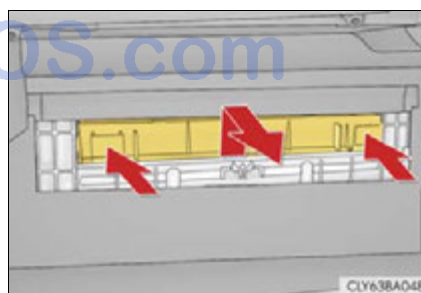

- 6** Remove the air conditioning filter from the filter case and replace it with a new one.

The "↑UP" marks shown on the filter and the filter case should be pointing up.

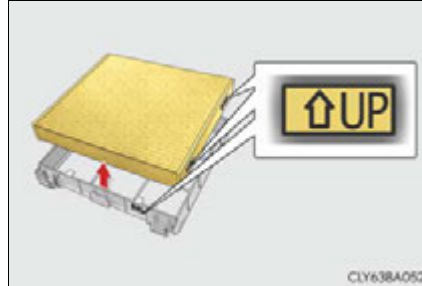

- 7** Reset the air conditioning filter maintenance data. (→P. 482)

■ **Rear air conditioning filter (if equipped)**

- 1** Turn the engine switch off.
- 2** Open the trunk lid. Remove the filter cover.

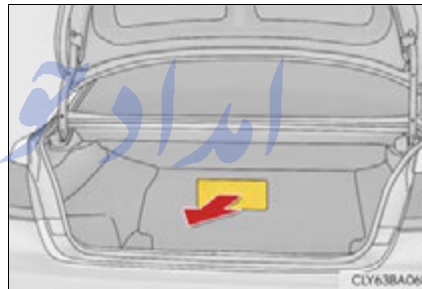

- 3** Remove the air conditioning filter and replace it with a new one.

The "↑UP" mark shown on the filter should be pointing up.



■ Checking interval

- ▶ Front air conditioning filter

Inspect and replace the air conditioning filter when a message is appeared on the multi-information display. In dusty areas or areas with heavy traffic flow, early replacement may be required. (For scheduled maintenance information, please refer to the "Owner's Manual Supplement" or "Scheduled Maintenance".)

- ▶ Rear air conditioning filter (if equipped)

Replace every 9000 miles (15000 km).

■ If air flow from the vents decreases dramatically

The filter may be clogged. Check the filter and replace if necessary.

■ After changing the front air conditioning filter

The front air conditioning filter maintenance data should be reset. Perform the following procedures:

- 1 Turn the engine switch to IGNITION ON mode.
- 2 Press and hold  (on the air conditioning panel) for 4 seconds or more.

A buzzer will sound to indicate that the maintenance data has been successfully reset.

■ Rear air conditioning filter (if equipped)

If it is necessary to clean or replace the filter, contact your Lexus dealer.

■ Climate control seat filter (if equipped)

Filters are installed in the seats. When it is necessary to clean or replace the filters, contact your Lexus dealer.



NOTICE

■ When using the air conditioning system

Make sure that a filter is always installed.

Using the air conditioning system without a filter may cause damage to the system.

Electronic key battery

Replace the battery with a new one if it is depleted.

You will need the following items:

- Flathead screwdriver
- Small flathead screwdriver
- Lithium battery CR1632

Replacing the battery

- 1 Take out the mechanical key.

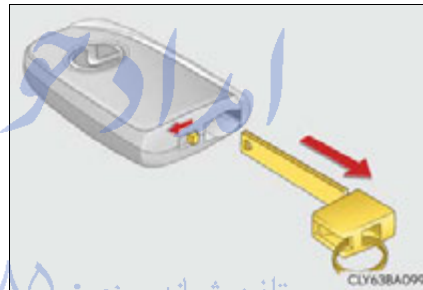

- 2 Remove the cover.

To prevent damage to the key, cover the tip of the screwdriver with a rag.



- 3 Remove the depleted battery.

Insert a new battery with the "+" terminal facing up.

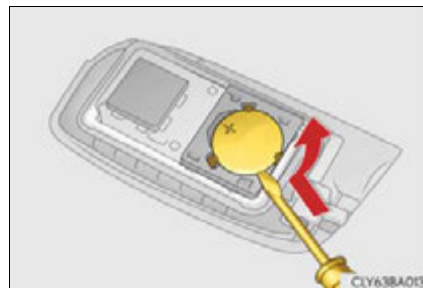

■ Use a CR1632 lithium battery

- Batteries can be purchased at your Lexus dealer, local electrical appliance shops or camera stores.
- Replace only with the same or equivalent type recommended by the manufacturer.
- Dispose of used batteries according to local laws.

■ When the card key battery needs to be replaced (if equipped)

The battery for the card key is available only at Lexus dealers. Your Lexus dealer can replace the battery for you.

■ If the electronic key battery is depleted

The following symptoms may occur:

- The smart access system with push-button start and wireless remote control will not function properly.
- The operational range will be reduced.

 CAUTION

■ Removed battery and other parts

These parts are small and if swallowed by a child, they can cause choking. Keep away from children. Failure to do so could result in death or serious injury.

 NOTICE

■ For normal operation after replacing the battery

Observe the following precautions to prevent accidents:

- Always work with dry hands.
Moisture may cause the battery to rust.
- Do not touch or move any other component inside the remote control.
- Do not bend either of the battery terminals.

Checking and replacing fuses

If any of the electrical components do not operate, a fuse may have blown. If this happens, check and replace the fuses as necessary.

- 1 Turn the engine switch off.
- 2 Open the fuse box cover.
 - ▶ Engine compartment (type A fuse box)

Remove the engine compartment cover (→P. 451) and push the tabs in and lift the lid off.

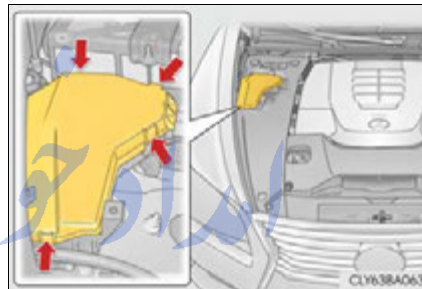

- ▶ Engine compartment (type B fuse box)

Remove the engine compartment cover (→P. 451) and push the tab in and lift the lid off.

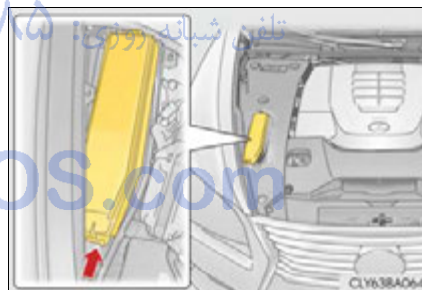

▶ Driver's side instrument panel

Remove the lid.



▶ Passenger's side instrument panel

Remove the lid.

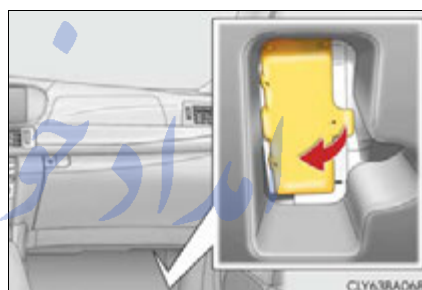

▶ Trunk

Remove the lid.



3 Remove the fuse with the pullout tool.

Only type A fuse can be removed using the pullout tool.

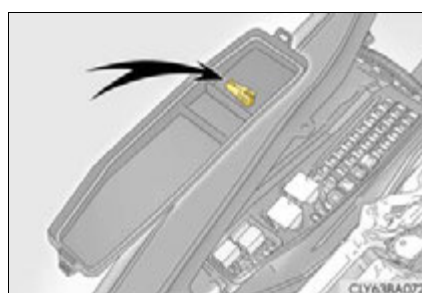

4 Check if the fuse is blown.

- ① Normal fuse
- ② Blown fuse

Type A and B:

Replace the blown fuse with a new fuse of an appropriate amperage rating. The amperage rating can be found on the fuse box lid.

Type C and D:

Contact your Lexus dealer.

► Type A

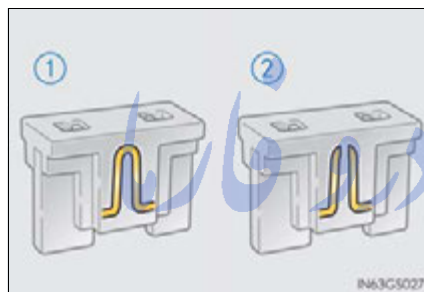

► Type B

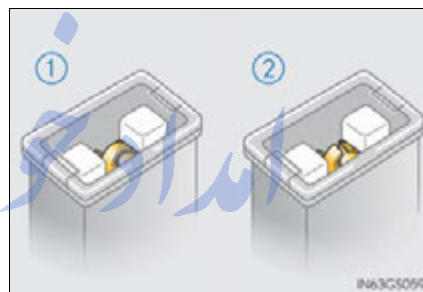

► Type C

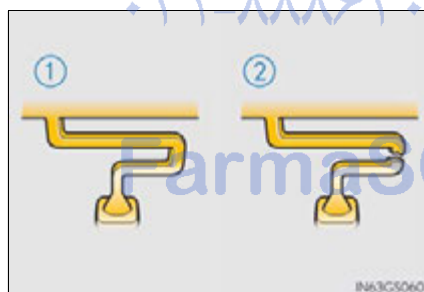

► Type D



■ After a fuse is replaced

- If the lights do not turn on even after the fuse has been replaced, a bulb may need replacement. (→P. 491)
- If the replaced fuse blows again, have the vehicle inspected by your Lexus dealer.

■ If there is an overload in a circuit

The fuses are designed to blow, protecting the wiring harness from damage.

⚠ CAUTION**■ To prevent system breakdowns and vehicle fire**

Observe the following precautions.

Failure to do so may cause damage to the vehicle, and possibly a fire or injury.

- Never use a fuse of a higher amperage rating than that indicated, or use any other object in place of a fuse.
- Always use a genuine Lexus fuse or equivalent.
Never replace a fuse with a wire, even as a temporary fix.
- Do not modify the fuses or fuse boxes.

⚠ NOTICE**■ Before replacing fuses**

Have the cause of electrical overload determined and repaired by your Lexus dealer as soon as possible.

Headlight aim

Removing the engine compartment cover

→P. 451

Vertical movement adjusting bolts

- ① Adjustment bolt A
- ② Adjustment bolt B

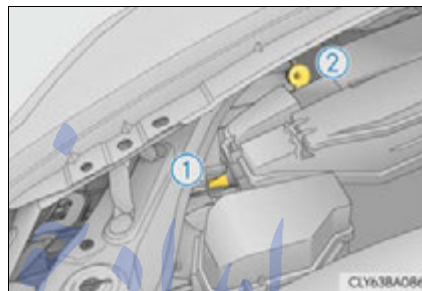

Before checking the headlight aim

- ❶ Make sure the vehicle has a full tank of gasoline and the area around the headlight is not deformed.
- ❷ Park the vehicle on level ground.
- ❸ Sit in the driver's seat.
- ❹ Bounce the vehicle several times.

Adjusting the headlight aim

- 1 Using a Phillips-head screwdriver, turn bolt A in either direction.

Remember the turning direction and the number of turns.

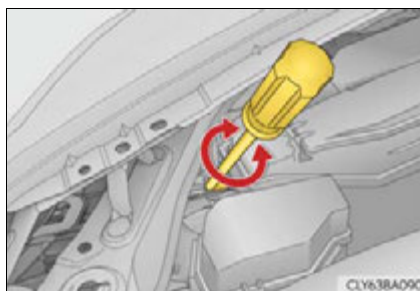

- 2 Turn bolt B the same number of turns and in the same direction as step 1.

If the headlight cannot be adjusted using this procedure, take the vehicle to your Lexus dealer to adjust the headlight aim.

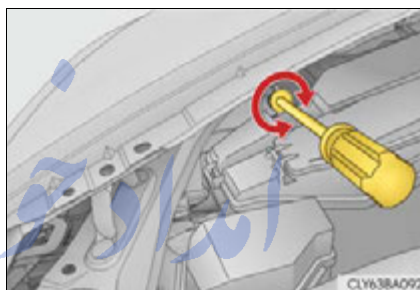

تلفن شبانه روزی: ۰۲۱-۸۸۸۶۲۰۸۵

FarmaSOS.com

Light bulbs

If any lights burn out, have it replaced by your Lexus dealer.

■ Discharge headlights (if equipped)

If voltage to the discharge bulbs is insufficient, the bulbs may not come on, or may go out temporarily. The discharge bulbs will come on when normal power is restored.

■ LED Lights

The following lights consist of a number of LEDs. If any of the LEDs burn out, take your vehicle to your Lexus dealer to have the light replaced.

- Parking lights and daytime running lights
- Front side marker lights
- Front turn signal lights
- Front fog lights
- Side turn signal lights
- Outer foot lights
- Tail lights
- Stop lights
- Back-up lights
- Rear side marker lights
- Rear turn signal lights
- High mounted stoplight
- License plate lights
- ▶ Vehicles with LED headlights
 - Headlight low beams
 - Headlight low/high beams
 - Headlight high beams (vehicles without LKA [Lane-Keeping Assist])

■ Condensation build-up on the inside of the lens

Temporary condensation build-up on the inside of the headlight lens does not indicate a malfunction. Contact your Lexus dealer for more information in the following situations:

- Large drops of water have built up on the inside of the lens.
- Water has built up inside the headlight.

⚠ CAUTION**■ Handling lights**

Do not touch the lights while they are on or immediately after they have been turned off. Doing so may result in burns.

■ Discharge headlights (if equipped)

● Do not touch the discharge headlight's high voltage socket when the headlights are turned on.

An extremely high voltage of 30000 V will be discharged and could result in serious injury or death by electric shock.

● Do not attempt to take apart or repair the low beam discharge headlight bulbs, connectors, power supply circuits, or related components.

Doing so could result in electric shock and serious injury or death.

امداد خودرو فارما

تلفن شبانه روزی: ۰۲۱-۸۸۸۶۲۰۸۵

FarmaSOS.com

7-1. Essential information

Emergency flashers 494

If your vehicle has to
be stopped in an
emergency..... 495**7-2. Steps to take in an
emergency**If your vehicle needs to be
towed 496If you think something is
wrong 502Fuel pump shut off
system 503If a warning light turns on or a
warning buzzer sounds 504If a warning message is
displayed..... 514If you have a flat tire (vehicles
with a spare tire) 518If you have a flat tire
(vehicles with run-
flat tires)..... 527

If the engine will not start 529

If the shift lever cannot be
shifted from P..... 531If the parking brake cannot
be released 532If the electronic key does not
operate properly 536If the vehicle battery is
discharged 539

If your vehicle overheats 543

If the vehicle becomes
stuck 547

Emergency flashers

The emergency flashers are used to warn other drivers when the vehicle has to be stopped in the road due to a breakdown, etc.

Press the switch.

All the turn signals will flash.

To turn them off, press the switch once again.



■ Emergency flashers

If the emergency flashers are used for a long time while the engine is not operating, the battery may discharge.

تلفن شبانه روزی: ۰۲۱-۸۸۸۶۲۰۸۵

FarmaSOS.com

If your vehicle has to be stopped in an emergency

Only in an emergency, such as if it becomes impossible to stop the vehicle in the normal way, stop the vehicle using the following procedure:

- 1 Steadily step on the brake pedal with both feet and firmly depress it.
Do not pump the brake pedal repeatedly as this will increase the effort required to slow the vehicle.
- 2 Shift the shift lever to N.
 - ▶ If the shift lever is shifted to N
- 3 After slowing down, stop the vehicle in a safe place by the road.
- 4 Stop the engine.
 - ▶ If the shift lever cannot be shifted to N
- 3 Keep depressing the brake pedal with both feet to reduce vehicle speed as much as possible.
- 4 To stop the engine, press and hold the engine switch for 2 consecutive seconds or more, or press it briefly 3 times or more in succession.



Press and hold for 2 seconds or more, or press briefly 3 times or more

CV718A001
- 5 Stop the vehicle in a safe place by the road.

⚠ CAUTION

■ If the engine has to be turned off while driving

Power assist for the steering wheel will be lost, making the steering wheel heavier to turn. Decelerate as much as possible before turning off the engine.

If your vehicle needs to be towed

If towing is necessary, we recommend having your vehicle towed by your Lexus dealer or commercial towing service, using a wheel-lift type truck or flatbed truck.

Use a safety chain system for all towing, and abide by all state/provincial and local laws.

Situations when it is necessary to contact dealers before towing

The following may indicate a problem with your transmission. Contact your Lexus dealer or commercial towing service before towing.

- The engine is running but the vehicle does not move.
- The vehicle makes an abnormal sound.

تلفن شبانه روزی: ۰۲۱-۸۸۶۲۰۸۵

FarmaSOS.com

Towing with a sling-type truck

Do not tow with a sling-type truck to prevent body damage.

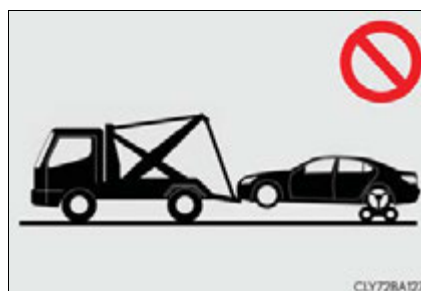

Towing with a wheel-lift type truck

► From the front



Use a towing dolly under the rear wheels.

► From the rear

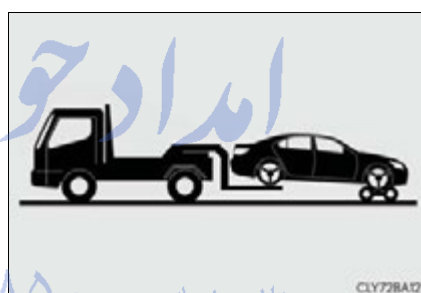

Use a towing dolly under the front wheels.

FarmaSOS.com

Using a flatbed truck

If your vehicle is transported by a flatbed truck, it should be tied down at the locations shown in the illustration.

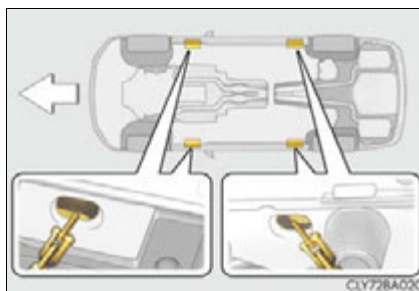

If you use chains or cables to tie down your vehicle, the angles shaded in black must be 45°.

Do not overly tighten the tie downs or the vehicle may be damaged.

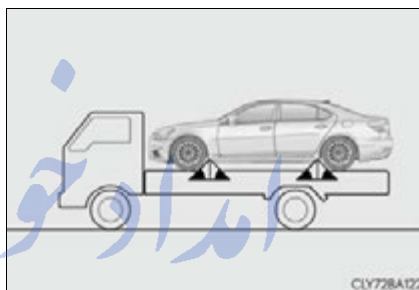

Emergency towing

If a tow truck is not available in an emergency, your vehicle may be temporarily towed using cables or chains secured to the emergency towing eyelets. This should only be attempted on hard surfaced roads for at most 50 miles (80 km) at under 18 mph (30 km/h).

A driver must be in the vehicle to steer and operate the brakes. The vehicle's wheels, drive train, axles, steering and brakes must be in good condition.

Emergency towing procedure

- 1 Take out the towing eyelet. (→P. 519, 528)

- 2 Remove the eyelet cover using a flathead screwdriver.

To protect the bodywork, place a rag between the screwdriver and the vehicle body as shown in the illustration.

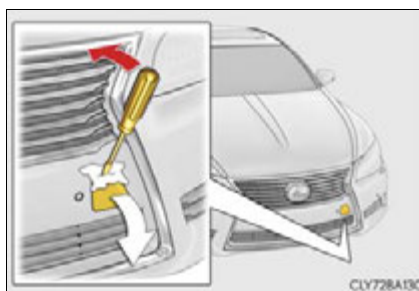

- 3 Insert the towing eyelet into the hole and tighten partially by hand.



- 4 Tighten down the towing eyelet securely using a wheel nut wrench or hard metal bar.

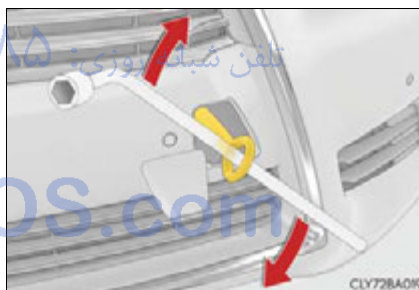

- 5 Securely attach cables or chains to the towing eyelet.

Take care not to damage the vehicle body.

- 6 Enter the vehicle being towed and start the engine.

If the engine does not start, turn the engine switch to IGNITION ON mode.

- 7 Shift the shift lever to N and release the parking brake.

When the shift lever cannot be shifted: →P. 531

■ While towing

If the engine is not running, the power assist for the brakes and steering will not function, making steering and braking more difficult.

■ Wheel nut wrench

Wheel nut wrench is installed in trunk. (→P. 519, 528)

⚠ CAUTION

Observe the following precautions.
Failure to do so may result in death or serious injury.

■ When towing the vehicle

▶ 2WD models

Be sure to transport the vehicle with all four wheels raised off the ground. If the vehicle is towed with the tires contacting the ground, the drivetrain and related parts may be damaged or an accident may occur due to a change in direction of the vehicle.



▶ AWD models

Be sure to transport the vehicle with all four wheels raised off the ground. If the vehicle is towed with the tires contacting the ground, the drivetrain or related parts may be damaged, the vehicle may fly off the truck.

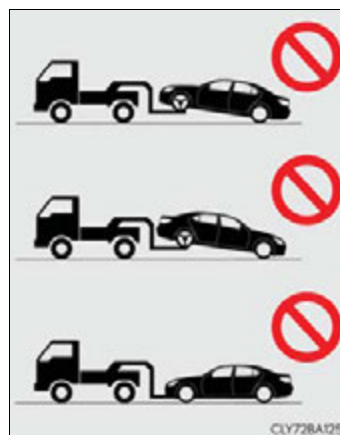

 CAUTION

■ While towing

- When towing using cables or chains, avoid sudden starts, etc. which place excessive stress on the towing eyelets, cables or chains. The towing eyelets, cables or chains may become damaged, broken debris may hit people, and cause serious damage.
- Do not turn the engine switch off.
There is a possibility that the steering wheel is locked and cannot be operated.

■ Installing towing eyelets to the vehicle

Make sure that towing eyelets are installed securely.
If not securely installed, towing eyelets may come loose during towing.

 NOTICE

■ To prevent damage to the vehicle when towing using a wheel-lift type truck

- Do not tow the vehicle from the rear when the engine switch is off. The steering lock mechanism is not strong enough to hold the front wheels straight.
- When raising the vehicle, ensure adequate ground clearance for towing at the opposite end of the raised vehicle. Without adequate clearance, the vehicle could be damaged while being towed.

■ To prevent damage to the vehicle when towing with a sling-type truck

Do not tow with a sling-type truck, either from the front or rear.

■ To prevent damage to the vehicle during emergency towing

Do not secure cables or chains to the suspension components.

If you think something is wrong

If you notice any of the following symptoms, your vehicle probably needs adjustment or repair. Contact your Lexus dealer as soon as possible.

Visible symptoms

- Fluid leaks under the vehicle.
(Water dripping from the air conditioning after use is normal.)
- Flat-looking tires or uneven tire wear
- Engine coolant temperature gauge needle continually points higher than normal.

Audible symptoms

- Changes in exhaust sound
- Excessive tire squeal when cornering
- Strange noises related to the suspension system
- Pinging or other noises related to the engine

Operational symptoms

- Engine missing, stumbling or running roughly
- Appreciable loss of power
- Vehicle pulls heavily to one side when braking
- Vehicle pulls heavily to one side when driving on a level road
- Loss of brake effectiveness, spongy feeling, pedal almost touches the floor

Fuel pump shut off system

To minimize the risk of fuel leakage when the engine stalls or when an airbag inflates upon collision, the fuel pump shut off system stops the supply of fuel to the engine.

Follow the procedure below to restart the engine after the system is activated.

- 1 Turn the engine switch to ACCESSORY mode or turn it off.
- 2 Restart the engine.

NOTICE

■ Before starting the engine

Inspect the ground under the vehicle.

If you find that fuel has leaked onto the ground, the fuel system has been damaged and is in need of repair. Do not restart the engine.

تلفن شبانه روزی: ۰۲۱-۸۸۶۲۰۸۵



FarmaSOS.com

If a warning light turns on or a warning buzzer sounds

Calmly perform the following actions if any of the warning lights comes on or flashes. If a light comes on or flashes, but then goes off, this does not necessarily indicate a malfunction in the system. However, if this continues to occur, have the vehicle inspected by your Lexus dealer.

Stop the vehicle immediately. Continuing to drive the vehicle may be dangerous.

The following warning indicates a possible problem in the brake system. Immediately stop the vehicle in a safe place and contact your Lexus dealer.

Warning light	Warning light/Details
 (U.S.A.)	Brake system warning light (warning buzzer) <ul style="list-style-type: none"> • Low brake fluid • Malfunction in the electronically controlled brake system
 (Canada)	

FarmaSOS.com







Stop the vehicle immediately.







The following warning indicates the possibility of damage to the vehicle that may lead to an accident. Immediately stop the vehicle in a safe place and contact your Lexus dealer.

Warning light	Warning light/Details
	Charging system warning light Indicates a malfunction in the vehicle's charging system

Have the vehicle inspected by your Lexus dealer immediately.





Failure to investigate the cause of the following warnings may lead to the system operating abnormally and possibly cause an accident. Have the vehicle inspected by your Lexus dealer immediately.

Warning light	Warning light/Details
 (U.S.A.)  (Canada)	Malfunction indicator lamp Indicates a malfunction in: <ul style="list-style-type: none"> • The electronic engine control system; • The electronic throttle control system; or • The electronic automatic transmission control system
	SRS warning light Indicates a malfunction in: <ul style="list-style-type: none"> • The SRS airbag system; • The front passenger occupant classification system; • The seat belt pretensioner system; or • The active head restraints system
 (U.S.A.)  (Canada)	ABS warning light Indicates a malfunction in: <ul style="list-style-type: none"> • The ABS; or • The brake assist system
	Electric power steering system warning light (warning buzzer) Indicates a malfunction in the EPS (Electric Power Steering) system

Warning light	Warning light/Details
 <p>PCS (Flashes) (If equipped)</p>	<p>Pre-collision system warning light Indicates a malfunction in the pre-collision system The warning light will operate as follows, even when the system is not malfunctioning:</p> <ul style="list-style-type: none"> • The light will flash quickly when the system is operating. (→P. 293) • The light will turn on when the pre-collision braking is disabled. (→P. 289, 295) • The light will turn on when the system cannot temporarily be used.
	<p>Slip indicator Indicates a malfunction in:</p> <ul style="list-style-type: none"> • The VSC system; • The TRAC system; • The ABS; or • The hill-start assist control system <p>The light will flash when the VSC, the TRAC, the ABS or the hill-start assist control system is operating. (→P. 288)</p>
 <p>HOLD (Flashes)</p>	<p>Brake hold operated indicator Indicates a malfunction in the brake hold system</p>
 <p>PARK (Flashes) (U.S.A.)</p>  <p>(Flashes) (Canada)</p>	<p>Parking brake indicator Indicates a malfunction in the electric parking brake</p>
	<p>Brake system warning light Indicates a malfunction in:</p> <ul style="list-style-type: none"> • The electronically controlled brake system; or • The electric parking brake

Follow the correction procedures.

After taking the specified steps to correct the suspected problem, check that the warning light goes off.

Warning light	Warning light/Details	Correction procedure
	Open door warning light (warning buzzer)*1 Indicates that a door or the trunk is not fully closed	Check that all the doors and the trunk are closed.
 In the fuel gauge	Low fuel level warning light Indicates remaining fuel is approximately 3.4 gal. (13 L, 2.8 Imp. gal.) or less	Refuel the vehicle.
	Seat belt reminder light (warning buzzer)*2 Warns the driver and/or front passenger to fasten their seat belts	Fasten the seat belt. If the front passenger's seat is occupied, the front passenger's seat belt also needs to be fastened to make the warning light (warning buzzer) turn off.
	Master warning light A buzzer sounds and the warning light comes on and flashes to indicate that the master warning system has detected a malfunction.	→P. 514

Warning light	Warning light/Details	Correction procedure
	Tire pressure warning light	
	When the light comes on: Low tire inflation pressure such as <ul style="list-style-type: none"> • Natural causes (→P. 510) • Flat tire (→P. 518, 527) 	Adjust the tire inflation pressure (including the spare tire) to the specified level. The light will turn off after a few minutes. In case the light does not turn off even if the tire inflation pressure is adjusted, have the system checked by your Lexus dealer.
	When the light comes on after blinking for 1 minute: Malfunction in the tire pressure warning system (→P. 510)	Have the system checked by your Lexus dealer.

*1: Open door warning buzzer:

A buzzer will sound if the vehicle reaches a speed of 3 mph (5 km/h) with any door open.

*2: Driver's and front passenger's seat belt buzzer: *تلفن شبانه روزی: ۰۲۱-۸۸۶۲۰۸۵*

The driver's and front passenger's seat belt buzzer sounds to alert the driver and front passenger that his or her seat belt is not fastened. Once the engine switch is turned to IGNITION ON mode, the buzzer sounds for 6 seconds. If the vehicle reaches a speed of 12 mph (20 km/h), the buzzer sounds once. If the seat belt is still unfastened after 30 seconds, the buzzer will sound intermittently for 10 seconds. Then, if the seat belt is still unfastened, the buzzer will sound in a different tone for 20 more seconds.

■ SRS warning light

This warning light system monitors the airbag sensor assembly, front impact sensors, side impact sensors (front door), side impact sensors (front), side impact sensors (rear door) side impact sensors (rear), driver's seat position sensor, driver's seat belt buckle switch, front passenger occupant classification system (ECU and sensors), "AIR BAG ON" indicator light, "AIR BAG OFF" indicator light, front passenger's seat belt buckle switch, seat belt pretensioners and force limiters, airbags, interconnecting wiring and power sources. (→P. 46)

■ Front passenger detection sensor, seat belt reminder and warning buzzer

- If luggage is placed on the front passenger seat, the front passenger detection sensor may cause the warning light to flash and the warning buzzer to sound even if a passenger is not sitting in the seat.
- If a cushion is placed on the seat, the sensor may not detect a passenger, and the warning light may not operate properly.

■ Electric power steering system warning light (warning buzzer)

When the battery charge becomes insufficient of the voltage temporarily drops, the electric power steering system warning light may come on and the warning buzzer may sound.

■ If the malfunction indicator lamp comes on while driving

First check the following:

- Is the fuel tank empty?
If it is, fill the fuel tank immediately.
- Is the fuel tank cap loose?
If it is, tighten it securely.

The light will go off after several driving trips.
If the light does not go off even after several trips, contact your Lexus dealer as soon as possible.

■ When the tire pressure warning light comes on

Check the tire inflation pressure and adjust it to the appropriate level. Pushing the tire pressure warning reset switch will not turn off the tire pressure warning light.

■ **The tire pressure warning light may come on due to natural causes**

The tire pressure warning light may come on due to natural causes such as natural air leaks and tire inflation pressure changes caused by temperature. In this case, adjusting the tire inflation pressure will turn off the warning light (after a few minutes).

■ **When a tire is replaced with a spare tire (vehicles with a spare tire)**

The spare tire is also equipped with a tire pressure warning valve and transmitter. The tire pressure warning light will turn on if the tire inflation pressure of the spare tire is low. If a tire goes flat, the tire pressure warning light will not turn off even though the flat tire has been replaced with the spare tire.

■ **Conditions that the tire pressure warning system may not function properly**

→P. 470

■ **If the tire pressure warning light frequently comes on after blinking for 1 minute**

If the tire pressure warning light frequently comes on after blinking for 1 minute when the engine switch is turned to IGNITION ON mode, have it checked by your Lexus dealer.

■ **Warning buzzer**

In some cases, the buzzer may not be heard due to ambient noise or sounds from the audio system.

■ **Customization**

The vehicle speed linked seat belt reminder buzzer can be disabled.

(Customizable features →P. 585)

FarmaSOS.com

 CAUTION

■ If both the ABS and the brake system warning lights remain on

Stop your vehicle in a safe place immediately and contact your Lexus dealer. The vehicle will become extremely unstable during braking, and the ABS system may fail, which could cause an accident resulting in death or serious injury.

■ When the electric power steering system warning light comes on

The steering wheel may become extremely heavy.
If the steering wheel becomes heavier than usual when operating, hold firmly and operate using more force than usual.

■ If the tire pressure warning light comes on

Be sure to observe the following precautions. Failure to do so could cause a loss of vehicle control and result in death or serious injury.

▶ Vehicles with a spare tire

- As the tire inflation pressure may be low when this warning light is illuminated, stop your vehicle in a safe place as soon as possible and adjust the tire inflation pressure immediately.

- If the tire pressure warning light comes on even after tire inflation pressure adjustment, it is probable that you have a flat tire. Check the tires. If a tire is flat, change it with the spare tire and have the flat tire repaired by the nearest Lexus dealer.

- Avoid abrupt maneuvering and braking. If the vehicle tires deteriorate, you could lose control of the steering wheel or the brakes.

▶ Vehicles with run-flat tires

- Decelerate to the lowest appropriate speed as soon as possible. Do not drive over 50 mph (80 km/h).

- Check and adjust the tire inflation pressure immediately.

- If the tire pressure warning light comes on even after tire inflation pressure adjustment, it is probable that you have a flat tire. Have the tire replaced by the nearest Lexus dealer.

- Avoid abrupt maneuvering and braking. If the vehicle tires deteriorate, you could lose control of the steering wheel or the brakes.

■ If a blowout or sudden air leakage should occur

The tire pressure warning system may not activate immediately.

 CAUTION**■ Maintenance of the tires**

Each tire, including the spare (if provided), should be checked monthly when cold and inflated to the inflation pressure recommended by the vehicle manufacturer on the vehicle placard or tire inflation pressure label (tire and load information label). (If your vehicle has tires of a different size than the size indicated on the vehicle placard or tire inflation pressure label [tire and load information label], you should determine the proper tire inflation pressure for those tires.)

As an added safety feature, your vehicle has been equipped with a tire pressure monitoring system (TPMS-tire pressure warning system) that illuminates a low tire pressure telltale (tire pressure warning light) when one or more of your tires is significantly under-inflated. Accordingly, when the low tire pressure telltale (tire pressure warning light) illuminates, you should stop and check your tires as soon as possible, and inflate them to the proper pressure. Driving on a significantly under-inflated tire causes the tire to overheat and can lead to tire failure. Under-inflation also reduces fuel efficiency and tire tread life, and may affect the vehicle's handling and stopping ability.

Please note that the TPMS (tire pressure warning system) is not a substitute for proper tire maintenance, and it is the driver's responsibility to maintain correct tire pressure, even if under-inflation has not reached the level to trigger illumination of the TPMS low tire pressure telltale (tire pressure warning light).

Your vehicle has also been equipped with a TPMS (tire pressure warning system) malfunction indicator to indicate when the system is not operating properly. The TPMS (tire pressure warning system) malfunction indicator is combined with the low tire pressure telltale (tire pressure warning light). When the system detects a malfunction, the telltale will flash for approximately one minute and then remain continuously illuminated. This sequence will continue upon subsequent vehicle start-ups as long as the malfunction exists. When the malfunction indicator is illuminated, the system may not be able to detect or signal low tire pressure as intended.

⚠ CAUTION

TPMS (tire pressure warning system) malfunctions may occur for a variety of reasons, including the installation of replacement or alternate tires or wheels on the vehicle that prevent the TPMS (tire pressure warning system) from functioning properly. Always check the TPMS (tire pressure warning system) malfunction telltale after replacing one or more tires or wheels on your vehicle to ensure that the replacement or alternate tires and wheels allow the TPMS (tire pressure warning system) to continue to function properly.

⚠ NOTICE**■ To ensure the tire pressure warning system operates properly**

Do not install tires with different specifications or makers, as the tire pressure warning system may not operate properly.

تلفن شبانه روزی: ۰۲۱-۸۸۶۲۰۸۵

FarmaSOS.com

If a warning message is displayed

The multi-information display shows warnings for system malfunctions, incorrectly performed operations, and messages that indicate a need for maintenance. When a message is shown, perform the correction procedure appropriate to the message.

① Master warning light

The master warning light also comes on or flashes in order to indicate that a message is currently being displayed on the multi-information display.

② Multi-information display

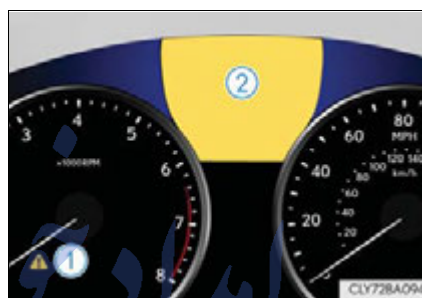

If any of the warning messages is shown again after the following actions have been performed, contact your Lexus dealer.

تلفن شبانه روزی: ۰۲۱-۸۸۸۶۲۰۸۵

FarmaSOS.com

Messages and warnings

The warning lights and warning buzzers operate as follows depending on the content of the message. If a message indicates the need for inspection by a dealer, have the vehicle inspected by your Lexus dealer immediately.

 System warning light	System warning light	Warning buzzer [*]	Warning
Remains on	—	Sounds	Indicates an important situation such as the malfunction of the system related to driving that may result in danger
—	Remains on or flashes	Sounds	Indicates an important situation such as the malfunction of the system shown on the multi-information display
Flashes	—	Sounds	Indicates a situation such as damage to the vehicle that may result in danger
Remains on	—	Does not sound	Indicates a condition such as a malfunction of electrical components and the need for maintenance
Flashes	—	Does not sound	Indicates a situation such as the incorrect performance of an operation and how to perform the operation correctly

*: A buzzer sounds the first time a message is shown on the multi-information display.

■ Warning message in radar cruise mode (if equipped)

In the following cases, the warning message may not be displayed even if vehicle-to-vehicle distance decreases:

- When your vehicle and the vehicle ahead are traveling at the same speed or the vehicle ahead is traveling more quickly than your vehicle
- When the vehicle ahead is traveling at a very low speed
- Immediately after cruise control speed is set
- At the instant the accelerator pedal is depressed

■ The LKA (Lane-Keeping Assist) lane departure warning function (if equipped)

In the following cases, the warning message will not be displayed even if a lane line is crossed.

- When the vehicle speed deviates from the operating range of the LKA system functions
- When the lane lines cannot be recognized
- When the steering wheel is turned as far as necessary to cause the vehicle to change lanes

■ System warning lights

The master warning light does not come on or flash in the following cases. Instead, a separate system warning light will come on or flash along with the message shown on the multi-information display.

- Malfunction of the brake system
The brake system warning light (red indicator) comes on. (→P. 504)
- Malfunction of the electronically controlled brake system or electric parking brake
The brake system warning light (yellow indicator) comes on. (→P. 506)
- Malfunction of the ABS
The ABS warning light comes on. (→P. 505)
- Malfunction of the charging system
The charging system warning light comes on. (→P. 505)
- Indicates that a door or the trunk is not fully closed
The open door warning light comes on. (→P. 507)
- High engine coolant temperature
The needle of the engine coolant temperature gauge enters the red zone. (→P. 543)

■ If “Oil maintenance required” is shown

Indicates that the engine oil should be changed. (After the engine oil is changed and the oil maintenance data has been reset.)

Check and change the engine oil, and oil filter by your Lexus dealer. After changing the engine oil, the oil change system should be reset. (→P. 455)

■ If “Maintenance required” is shown (U.S.A. only)

Perform the necessary maintenance.

Please reset the message after the maintenance is performed. (→P. 436)

■ When “Electrical equipment operation is limited” is shown

This message indicates that the battery is low. When the message is shown, operation of electrical equipment that uses a large amount of electric power, such as the air conditioning system, may be limited temporarily. This does not indicate a malfunction. Operation of electrical equipment will be restored after the battery is charged.

■ Warning buzzer

In some cases, the buzzer may not be heard due to ambient noise or sounds from the audio system.

تلفن شبانه روزی: ۰۲۱-۸۸۸۶۲۰۸۵

FarmaSOS.com

If you have a flat tire (vehicles with a spare tire)

Your vehicle is equipped with a spare tire. The flat tire can be replaced with the spare tire.

For details about tires: →P. 464

⚠ CAUTION

■ If you have a flat tire

Do not continue driving with a flat tire.

Driving even a short distance with a flat tire can damage the tire and the wheel beyond repair, which could result in an accident.

Before jacking up the vehicle

- Stop the vehicle on a hard, flat surface.
- Set the parking brake.
- Shift the shift lever to P.
- Stop the engine.
- Turn on the emergency flashers. (→P. 494)

FarmaSOS.com

Location of the spare tire, jack and tools

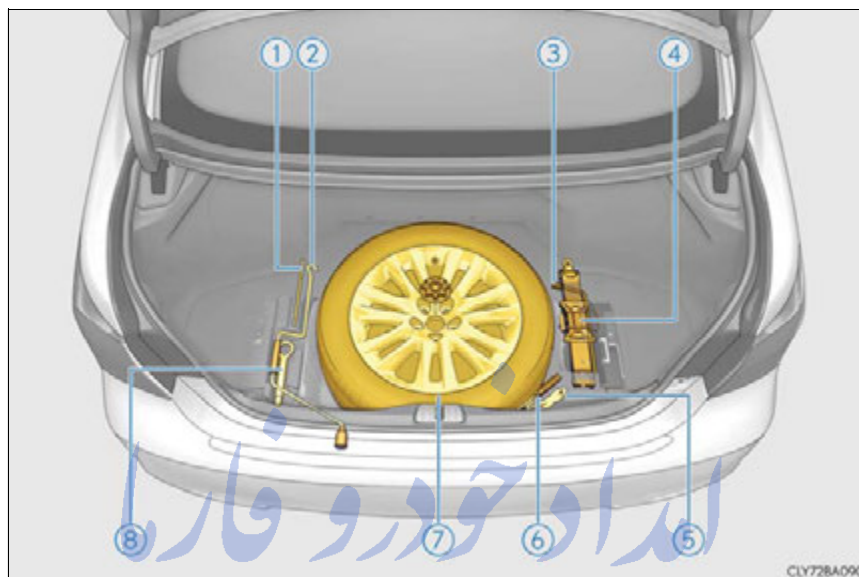

- | | |
|------------------------------|-----------------|
| ① Parking brake release tool | ⑤ Tools |
| ② Jack handle | ⑥ Screwdriver |
| ③ Wheel nut wrench | ⑦ Spare tire |
| ④ Jack | ⑧ Towing eyelet |

FarmaSOS.com

⚠ CAUTION**■ Using the tire jack**

Observe the following precautions.

Improper use of the tire jack may cause the vehicle to suddenly fall off the jack, leading to death or serious injury.

- Do not use the tire jack for any purpose other than replacing tires or installing and removing tire chains.
- Only use the tire jack that comes with this vehicle for replacing a flat tire. Do not use it on other vehicles, and do not use other tire jacks for replacing tires on this vehicle.
- Put the jack properly in its jack point.
- Do not put any part of your body under the vehicle while it is supported by the jack.
- Do not start the engine or drive the vehicle while the vehicle is supported by the jack.
- Do not raise the vehicle while someone is inside.
- When raising the vehicle, do not put an object on or under the jack.
- Do not raise the vehicle to a height greater than that required to replace the tire.
- Use a jack stand if it is necessary to get under the vehicle.
- Vehicles with electronically modulated air suspension: Be sure to turn off the height control and stop the engine.
- When lowering the vehicle, make sure that there is no-one near the vehicle. If there are people nearby, warn them vocally before lowering.

Taking out the jack and jack handle

- 1 Lift up the luggage mat and secure it by using the hook provided.
(→P. 380)
- 2 Remove the tool tray.

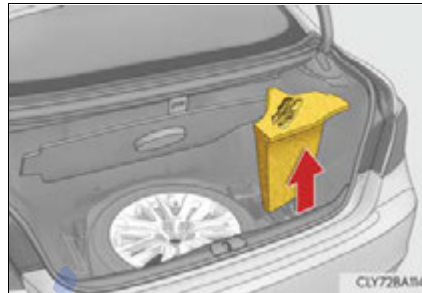

- 3 Remove the jack after removing the hook.

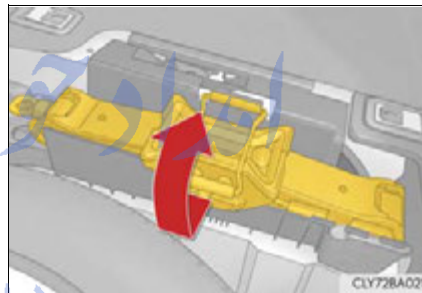

تلفن شبانه روزی: ۰۲۱-۸۸۸۶۲۰۸۵

FarmaSOS.com

Taking out the spare tire

1 Lift up the luggage mat and secure it by using the hook provided. (→P. 380)

2 Loosen the center fastener that secures the spare tire.

If the center fastener cannot be turned by hand, use the wheel nut wrench that is stored in the trunk. (To secure the tire, tighten the center fastener by hand. Do not use the wrench or other tools.)

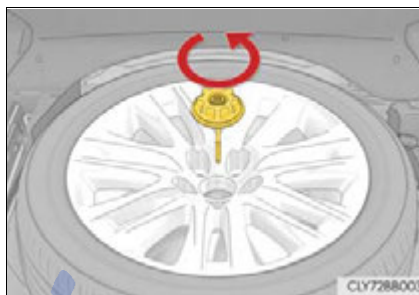

CAUTION

■ When storing the spare tire

Be careful not to catch fingers or other body parts between the spare tire and the body of the vehicle.

Replacing a flat tire

1 Chock the tires.



Flat tire		Wheel chock positions
Front	Left-hand side	Behind the rear right-hand side tire
	Right-hand side	Behind the rear left-hand side tire
Rear	Left-hand side	In front of the front right-hand side tire
	Right-hand side	In front of the front left-hand side tire

- 2 Slightly loosen the wheel nuts (one turn).

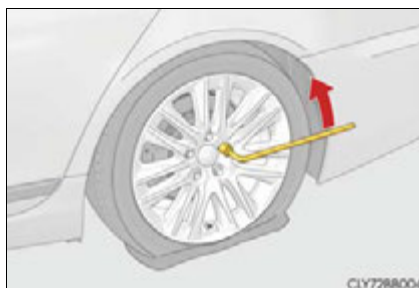

- 3 Turn the tire jack portion "A" by hand until the notch of the jack is in contact with the jack point.

The jack point guides are located under the rocker panel. They indicate the jack point positions.

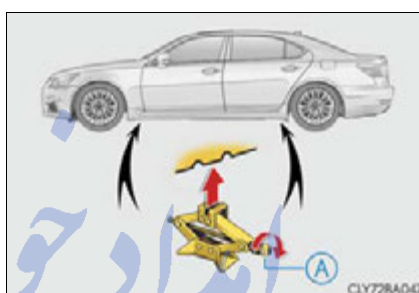

- 4 Raise the vehicle until the tire is slightly raised off the ground.

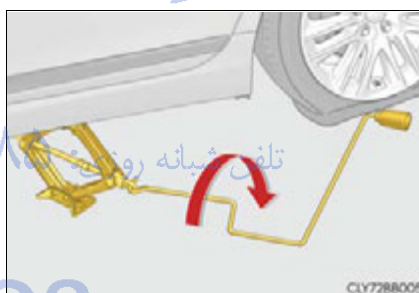

- 5 Remove all the wheel nuts and the tire.

When resting the tire on the ground, place the tire so that the wheel design faces up to avoid scratching the wheel surface.



- 6 Remove the wheel ornament by pushing from the reverse side.



⚠ CAUTION

■ Replacing a flat tire

- Observe the following precautions.
Failure to do so may result in serious injury:
 - Do not try to remove the wheel ornament by hand. Take due care in handling the ornament to avoid unexpected personal injury.
 - Do not touch the disc wheels or the area around the brakes immediately after the vehicle has been driven.
After the vehicle has been driven the disc wheels and the area around the brakes will be extremely hot. Touching these areas with hands, feet or other body parts while changing a tire, etc. may result in burns.
- Failure to follow these precautions could cause the wheel nuts to loosen and the tire to fall off, resulting in death or serious injury.
 - Never use oil or grease on the wheel bolts or wheel nuts.
Oil and grease may cause the wheel nuts to be excessively tightened, leading to bolt or disc wheel damage. In addition, the oil or grease can cause the wheel nuts to loosen and the wheel may fall off, causing a serious accident. Remove any oil or grease from the wheel bolts or wheel nuts.
 - Have the wheel nuts tightened with a torque wrench to 103 ft•lbf (140 N•m, 14.3 kgf•m) as soon as possible after changing wheels.
 - Do not attach a heavily damaged wheel ornament, as it may fly off the wheel while the vehicle is moving.
 - When installing a tire, only use wheel nuts that have been specifically designed for that wheel.
 - If there are any cracks or deformations in the bolt screws, nut threads or bolt holes of the wheel, have the vehicle inspected by your Lexus dealer.

Installing the spare tire

- 1 Remove any dirt or foreign matter from the wheel contact surface.

If foreign matter is on the wheel contact surface, the wheel nuts may loosen while the vehicle is in motion, causing the tire to come off.



- 2 Install the spare tire and loosely tighten each wheel nut by hand by approximately the same amount.

Turn the wheel nuts until the washers come into contact with the disc wheel.

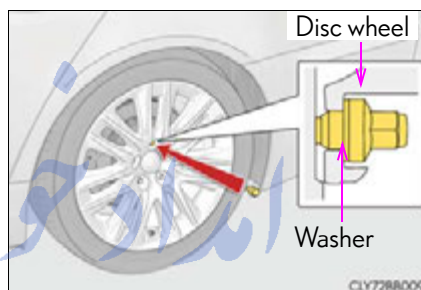

- 3 Lower the vehicle.



- 4 Firmly tighten each wheel nut two or three times in the order shown in the illustration.

Tightening torque:
103 ft•lbf (140 N•m, 14.3 kgf•m)

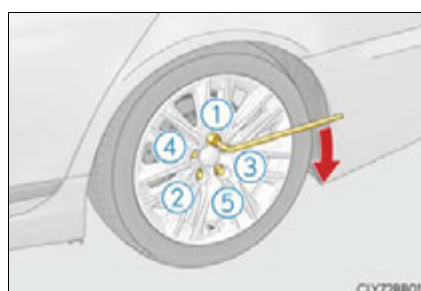

- 5 Reinstall the wheel ornament.

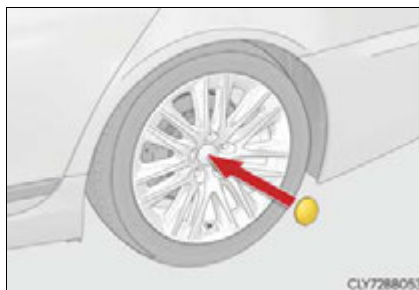

- 6 Stow the flat tire, tire jack and all tools.

⚠ CAUTION

■ **After using the tools and jack**

Before driving, make sure all the tools and jack are securely in place in their storage location to reduce the possibility of personal injury during a collision or sudden braking.

⚠ NOTICE

■ **When replacing the tires**

When removing or fitting the wheels, tires or the tire pressure warning valve and transmitter, contact your Lexus dealer as the tire pressure warning valve and transmitter may be damaged if not handled correctly.

■ **To avoid damage to the tire pressure warning valves and transmitters**

When a tire is repaired with liquid sealants, the tire pressure warning valve and transmitter may not operate properly. If a liquid sealant is used, contact your Lexus dealer or other qualified service shop as soon as possible. Make sure to replace the tire pressure warning valve and transmitter when replacing the tire. (→P. 466)

If you have a flat tire (vehicles with run-flat tires)

Your vehicle is not equipped with a spare tire, but instead you can continue driving the vehicle with run-flat tires even if any tire goes flat.

In this case, slow down and drive with extra caution.

■ Run-flat tires (A “RFT” or “DSST” mark is molded on the sidewall)

Take your vehicle to the nearest Lexus dealer or authorized tire dealer as soon as possible if any tire goes flat.

The vehicle can be driven for a maximum of 99 miles (160 km) at a speed below 50 mph (80 km/h) after the tire pressure warning light comes on. (→P. 508)



■ In some conditions (such as at high temperatures)

You cannot continue driving for up to 99 miles (160 km).

■ For the detailed information on run-flat tires

See the tire warranty booklet.

■ When replacing the tires

→P. 522

■ Location of the jack and tools

- 1 Lift up the handle and fold the trunk floor back. (→P. 380)
- 2 Remove the tool tray cover.



- 1 Jack handle
- 2 Towing eyelet
- 3 Parking brake release tool
- 4 Jack*
- 5 Screwdriver
- 6 Wheel nut wrench

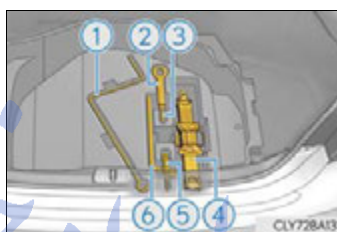

*: Use of the jack (→P. 522)

⚠ NOTICE

■ When replacing the tires

When removing or fitting the wheels, tires or the tire pressure warning valve and transmitter, contact your Lexus dealer as the tire pressure warning valve and transmitter may be damaged if not handled correctly.

■ When driving over bumps

If a vehicle has a flat tire, the vehicle height will be lower than usual. Ensure that nothing strikes the bottom of the vehicle.

■ To avoid damage to the tire pressure warning valves and transmitters

When a tire is repaired with liquid sealants, the tire pressure warning valve and transmitter may not operate properly. If a liquid sealant is used, contact your Lexus dealer or other qualified service shop as soon as possible. Make sure to replace the tire pressure warning valve and transmitter when replacing the tire. (→P. 466)

If the engine will not start

If the engine will not start even though correct starting procedures are being followed (→P. 208), consider each of the following points:

The engine will not start even though the starter motor operates normally.

One of the following may be the cause of the problem:

- There may not be sufficient fuel in the vehicle's tank.
Refuel the vehicle.
- The engine may be flooded.
Try to restart the engine again following correct starting procedures.
(→P. 208)
- There may be a malfunction in the engine immobilizer system.
(→P. 78)

The starter motor turns over slowly, the interior lights and headlights are dim, or the horn does not sound or sounds at a low volume.

One of the following may be the cause of the problem:

- The battery may be discharged. (→P. 539)
- The battery terminal connections may be loose or corroded.

The starter motor does not turn over

The engine starting system may be malfunctioning due to an electrical problem such as electronic key battery depletion or a blown fuse. However, an interim measure is available to start the engine. (→P. 530)

The starter motor does not turn over, the interior lights and headlights do not turn on, or the horn does not sound.

One of the following may be the cause of the problem:

- One or both of the battery terminals may be disconnected.
- The battery may be discharged. (→P. 539)
- There may be a malfunction in the steering lock system.

Contact your Lexus dealer if the problem cannot be repaired, or if repair procedures are unknown.

Emergency start function

When the engine does not start, the following steps can be used as an interim measure to start the engine if the engine switch is functioning normally:

- 1 Turn the engine switch to IGNITION ON mode (→P. 209) and check that the parking brake is set.
- 2 Shift the shift lever to P.
- 3 Turn the engine switch to ACCESSORY mode, تلفن شبانه ۰۲۱ ۸۸۶۲ ۸۸
- 4 Press and hold the engine switch for about 15 seconds while depressing the brake pedal firmly.

Even if the engine can be started using the above steps, the system may be malfunctioning. Have the vehicle inspected by your Lexus dealer.

If the shift lever cannot be shifted from P

If the shift lever cannot be shifted with your foot on the brake pedal, there may be a problem with the shift lock system (a system to prevent accidental operation of the shift lever). Have the vehicle inspected by your Lexus dealer immediately.

The following steps may be used as an emergency measure to ensure that the shift lever can be shifted:

- 1 Turn the engine switch to IGNITION ON mode (→P. 209) and check that the parking brake is set.
- 2 Turn the engine switch to ACCESSORY mode.
- 3 Depress the brake pedal.
- 4 Pry the cover up with a flathead screwdriver or equivalent tool.

To prevent damage to the cover, cover the tip of the screwdriver with a rag.

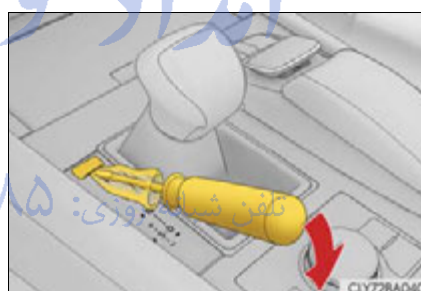

- 5 Press the shift lock override button.

The shift lever can be shifted while the button is pressed.



If the parking brake cannot be released

In the event that the battery is discharged or switch operation does not release the parking brake, the parking brake can be released manually using the procedure below. This procedure should be performed only if necessary, such as in an emergency.

If the switch cannot be operated even when the battery is normal, the parking brake system may be malfunctioning. Have the vehicle inspected by your Lexus dealer immediately.

Before releasing the parking brake manually

- Shift the shift lever to P.
- Turn the engine switch off.
- Check that the parking brake indicator is off.
- Check the tires.

Releasing the parking brake manually

- ▶ Vehicles with a spare tire
- 1 Take out the parking brake release tool and the screwdriver from the trunk. (→P. 519)
 - 2 Replace the screwdriver head with the parking brake release tool.
 - 3 Take out the spare tire. (→P. 522)

- 4 Remove the plug.

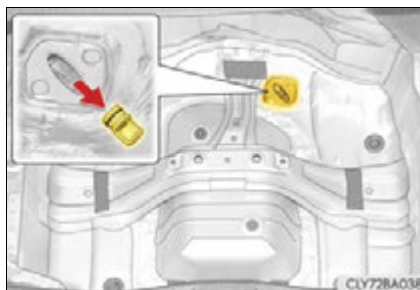

- 5 Insert the tool and press it down firmly while turning it counter-clockwise until it stops.

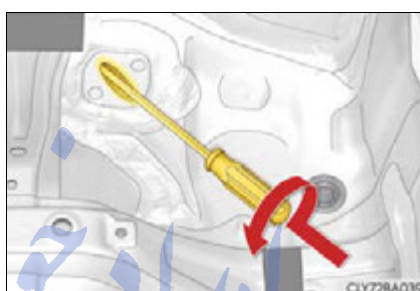

► Vehicles with run-flat tires

- 1 Take out the parking brake release tool and the screwdriver from the trunk. (→P. 528)
- 2 Check that the flathead end of the screwdriver is exposed.

If the Phillips end is exposed, reinsert the screwdriver shaft so the flathead end is exposed.

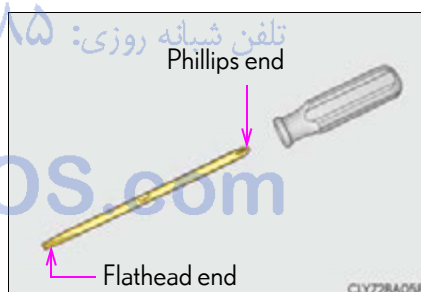

534 7-2. Steps to take in an emergency

- 3** Using the flathead end of the screwdriver, remove the clips.

When installing the tool tray clips:

→P. 535

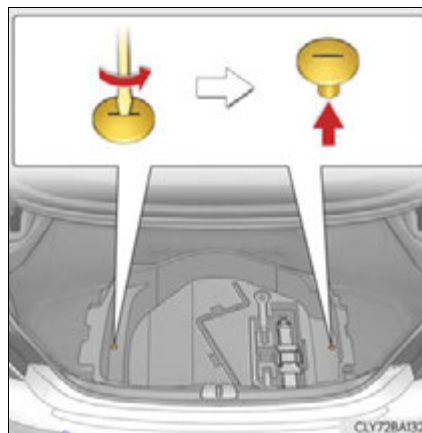

- 4** While lifting the rear side of the left and right side deck boards, remove the tool tray.

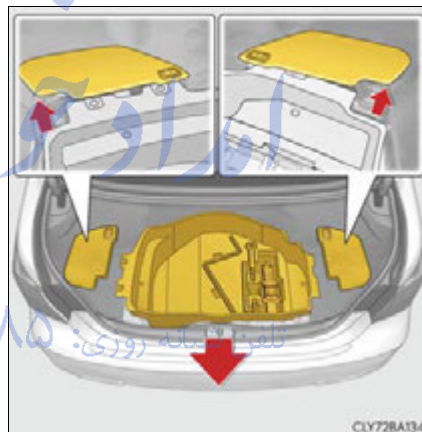

- 5** Remove the plug.

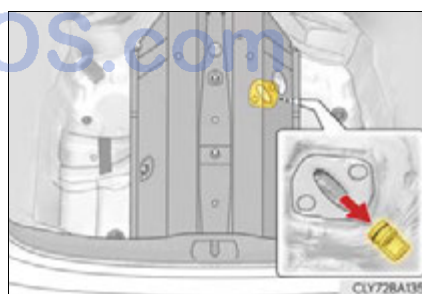

- 6 Replace the screwdriver head with the parking brake release tool.

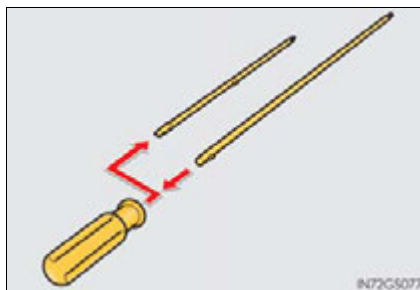

- 7 Insert the tool and press it down firmly while turning it counter-clockwise until it stops.

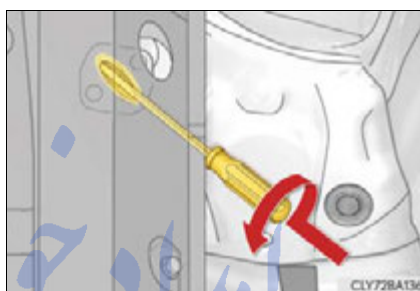

■ When installing the tool tray clips (vehicles with run-flat tires)

Install the clips as shown in the illustration.



■ Manual operation of the parking brake

The parking brake cannot be set manually.

⚠ CAUTION

■ When releasing the parking brake manually

- Shift the shift lever to P, turn the engine switch off and chock the tires. Failure to do so may cause the vehicle to move, resulting in an accident.
- Turn the engine switch off and check that the parking brake indicator is off. Failure to do so may cause the system to operate and turn the inserted parking brake release tool, resulting in an injury.

If the electronic key does not operate properly

If communication between the electronic key and vehicle is interrupted (→P. 122) or the electronic key cannot be used because the battery is depleted, the smart access system with push-button start and wireless remote control cannot be used. In such cases, the doors and trunk can be opened and the engine can be started by following the procedure below.

Locking and unlocking the doors, unlocking the trunk and key linked functions

Use the mechanical key built in to the electronic keys to operate the doors. (→P.109)

■ Doors

- 1 Remove the cover on the driver's door handle.

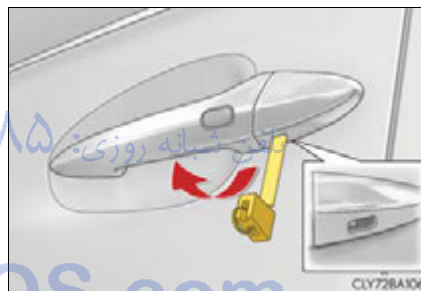

- 2 Locks and unlocks the doors

- 1 Locks all the doors
- 2 Closes the windows and moon roof (turn and hold)
- 3 Unlocks the door

Turning the key rearward unlocks the driver's door. Turning the key once again unlocks the other doors.

- 4 Opens the windows and moon roof (turn and hold)

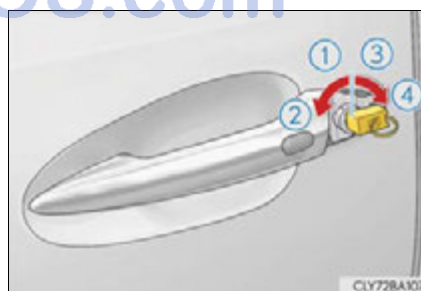

- 3 After the operation is completed, reinstall the cover.

Hook the upper claw of the cover onto the upper catch on the vehicle side, and then push on the lower side of the cover.

Make sure that the lower claw of the cover is securely fastened to the lower catch on the vehicle side. If the cover is not securely attached, it may fall off while driving.

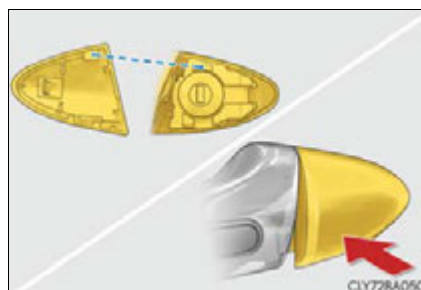

■ Trunk

Turn the mechanical key clockwise to open.



FarmaSOS.com

Starting the engine

- 1 Ensure that the shift lever is in P and depress the brake pedal.
- 2 Touch the Lexus emblem side of the electronic key to the engine switch.

If any of the doors is opened or closed after the key was touched to the switch to start the vehicle, an alarm will sound to indicate that the start function cannot detect the key.

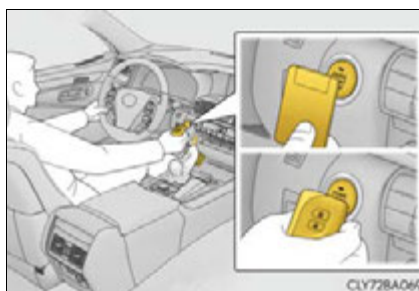

- 3 Press the engine switch within 10 seconds of the buzzer sounding, keeping the brake pedal depressed.

In the event that the engine still cannot be started, contact your Lexus dealer.

Stopping the engine

Shift the shift lever to P and press the engine switch as you normally do when stopping the engine.

Replacing the key battery

As the above procedure is a temporary measure, it is recommended that the electronic key battery be replaced immediately when the battery is depleted. (→P. 483)

Changing engine switch modes

Within 10 seconds of the buzzer sounding, release the brake pedal and press the engine switch.

The engine does not start and modes will be changed each time the switch is pressed. (→P. 209)

⚠ CAUTION

■ When using the mechanical key and operating the power windows or moon roof

Operate the power window or moon roof after checking to make sure that there is no possibility of any passenger having any of their body parts caught in the window or moon roof.

Also, do not allow children to operate the mechanical key. It is possible for children and other passengers to get caught in the power window or moon roof.

If the vehicle battery is discharged

The following procedures may be used to start the engine if the vehicle's battery is discharged.

You can also call your Lexus dealer or a qualified repair shop.

If you have a set of jumper (or booster) cables and a second vehicle with a 12-volt battery, you can jump start your vehicle by following the steps below.

- 1 Confirm that the electronic key is being carried.

When connecting the jumper (or booster) cables, depending on the situation, the alarm may activate and doors locked. (→P. 81)



- 2 Open the hood. Remove the engine compartment covers and battery cover. (→P. 446, 451, 452)

FarmaSOS.com

- 3 Connect the jumper cables according to the following procedure:

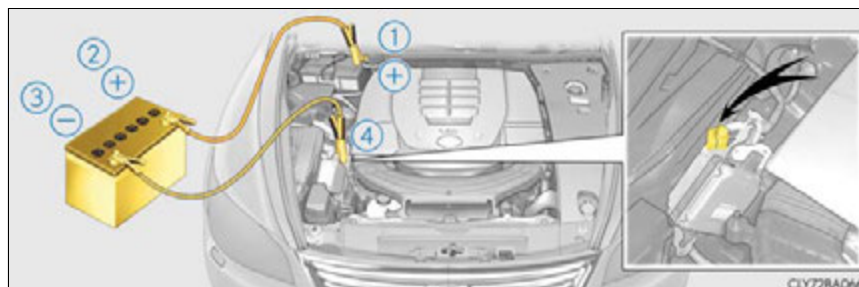

- ① Connect a positive jumper cable clamp to the positive (+) battery terminal on your vehicle.
- ② Connect the clamp on the other end of the positive cable to the positive (+) battery terminal on the second vehicle.
- ③ Connect a negative cable clamp to the negative (-) battery terminal on the second vehicle.
- ④ Connect the clamp at the other end of the negative cable to a solid, stationary, unpainted metallic point away from the battery and any moving parts, as shown in the illustration.
- 4 Start the engine of the second vehicle. Increase the engine speed slightly and maintain at that level for approximately 5 minutes to recharge the battery of your vehicle.
- 5 Open and close any of the doors of your vehicle with the engine switch off.
- 6 Maintain the engine speed of the second vehicle and start the engine of your vehicle by turning the engine switch to IGNITION ON mode.
- 7 Once the vehicle's engine has started, remove the jumper cables in the exact reverse order from which they were connected.

Once the engine starts, have the vehicle inspected at your Lexus dealer as soon as possible.

■ Starting the engine when the battery is discharged

The engine cannot be started by push-starting.

■ To prevent battery discharge

- Turn off the headlights and the audio system while the engine is off.
- Turn off any unnecessary electrical components when the vehicle is running at a low speed for an extended period, such as in heavy traffic.

■ Charging the battery

The electricity stored in the battery will discharge gradually even when the vehicle is not in use, due to natural discharge and the draining effects of certain electrical appliances. If the vehicle is left for a long time, the battery may discharge, and the engine may be unable to start. (The battery recharges automatically during driving.)

■ When recharging or replacing the battery

In some cases, it may not be possible to unlock the doors using the smart access system with push-button start when the battery is discharged. Use the wireless remote control or the mechanical key to lock or unlock the doors.

■ If the battery is discharged

The information stored in the computer will be deleted.

If the battery is discharged, have the vehicle inspected by your Lexus dealer.

تلفن شبانه روزی: ۰۲۱-۸۸۸۶۲۰۸۵

FarmaSOS.com

 CAUTION**■ Avoiding battery fires or explosions**

Observe the following precautions to prevent accidentally igniting the flammable gas that may be emitted from the battery:

- Make sure each jumper cable is connected to the correct terminal and that it is not unintentionally in contact with any other than the intended terminal.
- Do not allow the other end of the jumper cable connected to the "+" terminal to come into contact with any other parts or metal surfaces in the area, such as brackets or unpainted metal.
- Do not allow the + and - clamps of the jumper cables to come into contact with each other.
- Do not smoke, use matches, cigarette lighters or allow open flame near the battery.

■ Battery precautions

The battery contains poisonous and corrosive acidic electrolyte, while related parts contain lead and lead compounds. Observe the following precautions when handling the battery:

- When working with the battery, always wear safety glasses and take care not to allow any battery fluids (acid) to come into contact with skin, clothing or the vehicle body.
- Do not lean over the battery.
- In the event that battery fluid comes into contact with the skin or eyes, immediately wash the affected area with water and seek medical attention. Place a wet sponge or cloth over the affected area until medical attention can be received.
- Always wash your hands after handling the battery support, terminals, and other battery-related parts.
- Do not allow children near the battery.

 NOTICE**■ When handling jumper cables**

When connecting the jumper cables, ensure that they do not become entangled in the cooling fans or engine drive belt.

If your vehicle overheats

The following may indicate that your vehicle is overheating.

- The needle of the engine coolant temperature gauge (→P. 89) enters the red zone or a loss of engine power is experienced. (For example, the vehicle speed does not increase.)
- Steam comes out from under the hood.

Correction procedures

1 Stop the vehicle in a safe place and turn off the air conditioning system, and then stop the engine.

2 If you see steam:
Carefully lift the hood after the steam subsides.

If you do not see steam:
Carefully lift the hood.

3 After the engine has cooled down sufficiently, inspect the hoses and radiator core (radiator) for any leaks.

① Radiator

② Cooling fans

If a large amount of coolant leaks, immediately contact your Lexus dealer.



4 The coolant level is satisfactory if it is between the "FULL" and "LOW" lines on the reservoir.

- ① Reservoir
- ② "FULL"
- ③ "LOW"

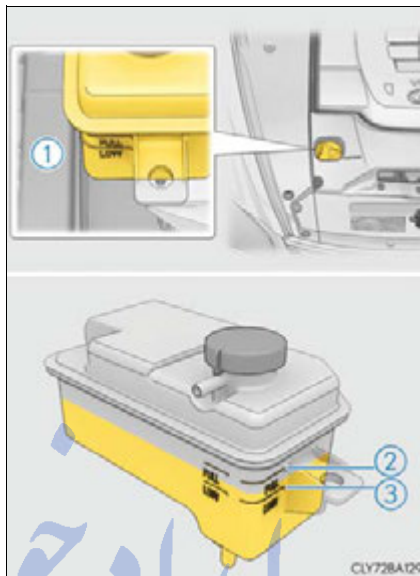

5 Add coolant if necessary.
(→P. 451)
Water can be used in an emergency if coolant is unavailable.

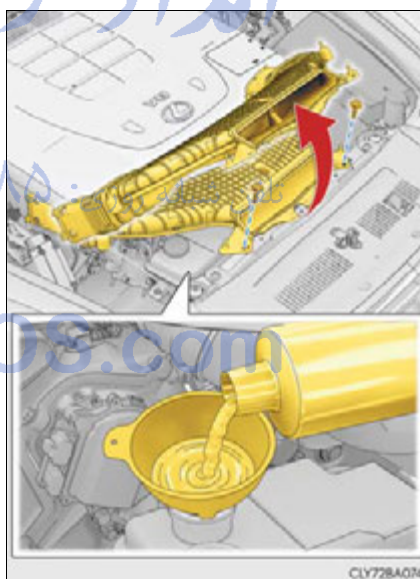

- 6 Start the engine and turn the air conditioning system on to check that the radiator cooling fan operates and to check for coolant leaks from the radiator or hoses.

The fan operates when the air conditioning system is turned on immediately after a cold start. Confirm that the fan is operating by checking the fan sound and air flow. If it is difficult to check these, turn the air conditioning system on and off repeatedly.

(The fan may not operate in freezing temperatures.)

- 7 If the fan is not operating:
Stop the engine immediately and contact your Lexus dealer.

If the fan is operating:

Have the vehicle inspected at the nearest Lexus dealer.

امداد خودرو فارما

تلفن شبانه روزی: ۰۲۱-۸۸۸۶۲۰۸۵

FarmaSOS.com

⚠ CAUTION

■ **When inspecting under the hood of your vehicle**

Observe the following precautions.

Failure to do so may result in serious injury such as burns.

- If steam is seen coming from under the hood, do not open the hood until the steam has subsided. The engine compartment may be very hot.
- Keep hands and clothing (especially a tie, a scarf or a muffler) away from the fans and belts. Failure to do so may cause the hands or clothing to be caught, resulting in serious injury.
- Do not loosen the coolant reservoir cap while the engine and radiator are hot. High temperature steam or coolant could spray out.

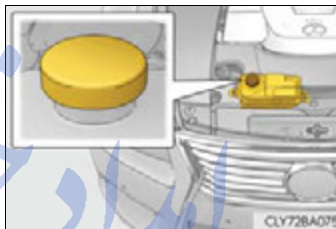

⚠ NOTICE

■ **When adding engine coolant**

Add coolant slowly after the engine has cooled down sufficiently. Adding cool coolant to a hot engine too quickly can cause damage to the engine.

■ **To prevent damage to the cooling system**

Observe the following precautions:

- Avoid contaminating the coolant with foreign matter (such as sand or dust etc.).
- Do not use any coolant additive.

If the vehicle becomes stuck

Carry out the following procedures if the tires spin or the vehicle becomes stuck in mud, dirt or snow:

- 1 Stop the engine. Set the parking brake and shift the shift lever to P.
- 2 Remove the mud, snow or sand from around the rear wheels.
- 3 Place wood, stones or some other material under the rear wheels to help provide traction.
- 4 Restart the engine.
- 5 Shift the shift lever to D or R and release the parking brake. Then, while exercising caution, depress the accelerator pedal.

■ When it is difficult to free the vehicle

Press  to turn off TRAC.

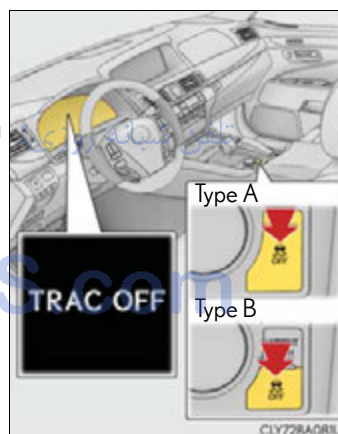

 CAUTION**■ When attempting to free a stuck vehicle**

If you choose to push the vehicle back and forth to free it, make sure the surrounding area is clear to avoid striking other vehicles, objects or people. The vehicle may also lunge forward or lunge back suddenly as it becomes free. Use extreme caution.

■ When shifting the shift lever

Be careful not to shift the shift lever with the accelerator pedal depressed. This may lead to unexpected rapid acceleration of the vehicle that may cause an accident resulting in death or serious injury.

 NOTICE**■ To avoid damaging the transmission and other components**

- Avoid spinning the rear wheels and depressing the accelerator pedal more than necessary.
- If the vehicle remains stuck even after these procedures are performed, the vehicle may require towing to be freed.

تلفن شبانه روزی: ۰۲۱-۸۸۶۲۰۸۵

FarmaSOS.com

8-1. Specifications

Maintenance data (fuel, oil level, etc.).....	550
Fuel information.....	563
Tire information.....	566

8-2. Customization

Customizable features	577
-----------------------------	-----

امداد خودرو فارما

تلفن شبانه روزی: ۰۲۱-۸۸۸۶۲۰۸۵

FarmaSOS.com

Maintenance data (fuel, oil level, etc.)

Dimensions and weight

Overall length		LS460	200.4 in. (5090 mm)
		LS460L	205.1 in. (5210 mm)
Overall width			73.8 in. (1875 mm)
Overall height *1		2WD models	58.1 in. (1475 mm) ^{*2} 57.7 in. (1465 mm) ^{*3} 57.3 in. (1455 mm) ^{*4}
		AWD models	58.3 in. (1480 mm) ^{*2} 57.7 in. (1465 mm) ^{*3} 57.3 in. (1455 mm) ^{*4}
Wheelbase		LS460	116.9 in. (2970 mm)
		LS460L	121.7 in. (3090 mm)
Tread	Front		63.6 in. (1615 mm) ^{*5} 63.4 in. (1610 mm) ^{*6}
	Rear	2WD models	63.8 in. (1620 mm) ^{*5} 63.6 in. (1615 mm) ^{*6}
		AWD models	63.6 in. (1615 mm) ^{*5} 63.4 in. (1610 mm) ^{*6}
Vehicle capacity weight (Occupants + luggage)			825 lb. (375 kg) ^{*7} 675 lb. (305 kg) ^{*8}

*1: Unladen vehicles

*2: Vehicles without electronically modulated air suspension

*3: Vehicles with electronically modulated air suspension but without paddle shift switches

*4: Vehicles with electronically modulated air suspension and paddle shift switches

*5: Vehicles with 18-inch tires

*6: Vehicles with 19-inch tires

*7: 5-seat models

*8: 4-seat models

Vehicle identification

■ Vehicle identification number

The vehicle identification number (VIN) is the legal identifier for your vehicle. This is the primary identification number for your Lexus. It is used in registering the ownership of your vehicle.

This number is stamped on the top left of the instrument panel and in the engine compartment.

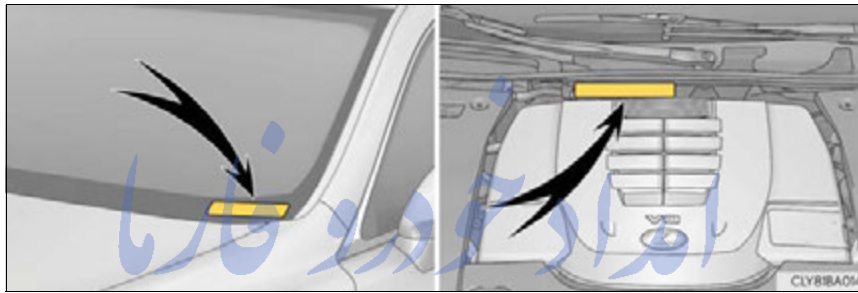

This number is also on the Certification Label.

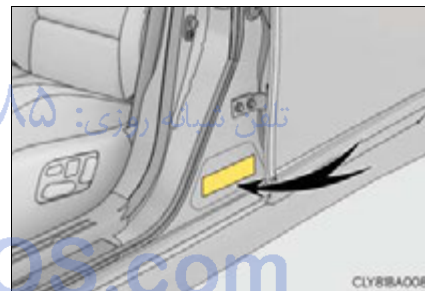

■ Engine number

▶ 2WD models

The engine number is stamped on the engine block as shown.



▶ AWD models

The engine number is stamped on the engine block as shown.

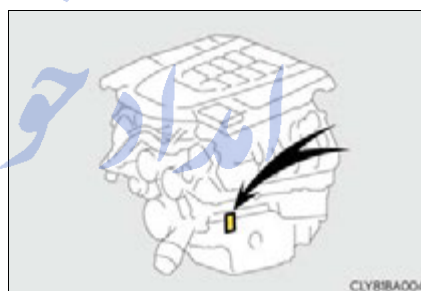

تلفن شبانه روزی: ۰۲۱-۸۸۸۶۲۰۸۵

FarmaSOS.com

Engine

Model	4.6 L 8-cylinder (1UR-FSE)
Type	8-cylinder V type, 4-cycle, gasoline
Bore and stroke	3.70 × 3.27 in. (94.0 × 83.0 mm)
Displacement	281.2 cu. in. (4608 cm ³)
Valve clearance (engine cold)	Automatic adjustment
Drive belt tension	Automatic adjustment

Fuel

Fuel type	Premium unleaded gasoline only
Octane Rating	91 (Research Octane Number 96) or higher
Fuel tank capacity (Reference)	22.2 gal. (84 L, 18.4 Imp. gal.)

Lubrication system

	2WD	AWD
Oil capacity Drain and refill (Reference [*])		
With filter	9.1 qt. (8.6 L, 7.6 Imp. qt.)	9.5 qt. (9.0 L, 7.9 Imp. qt.)
Without filter	8.9 qt. (8.4 L, 7.4 Imp. qt.)	8.9 qt. (8.4 L, 7.4 Imp. qt.)

*: The engine oil capacity is a reference quantity to be used when changing the engine oil. Warm up and turn off the engine, wait more than 5 minutes, and check the oil level on the dipstick.

■ Engine oil selection

“Toyota Genuine Motor Oil” is used in your Lexus vehicle. Use Lexus approved “Toyota Genuine Motor Oil” or equivalent to satisfy the following grade and viscosity.

Oil grade: ILSAC GF-5 multigrade engine oil

Recommended viscosity: SAE 0W-20

SAE 0W-20 is the best choice for good fuel economy and good starting in cold weather.

If SAE 0W-20 is not available, SAE 5W-20 oil may be used. However, it must be replaced with SAE 0W-20 at the next oil change.

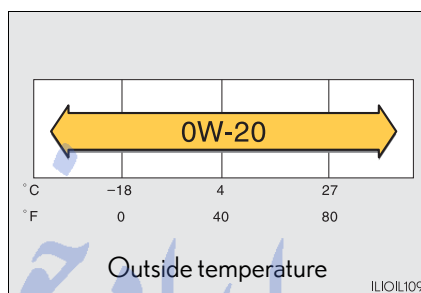

Oil viscosity (0W-20 is explained here as an example):

- The 0W in 0W-20 indicates the characteristic of the oil which allows cold startability. Oils with a lower value before the W allow for easier starting of the engine in cold weather.
- The 20 in 0W-20 indicates the viscosity characteristic of the oil when the oil is at high temperature. An oil with a higher viscosity (one with a higher value) may be better suited if the vehicle is operated at high speeds, or under extreme load conditions.

How to read oil container label:

The International Lubricant Specification Advisory Committee (ILSAC) Certification Mark is added to some oil containers to help you select the oil you should use.



Cooling system

Capacity	2WD models	11.6 qt. (11.0 L, 9.7 Imp. qt.)
	AWD models	11.7 qt. (11.1 L, 9.8 Imp. qt.)
Coolant type		<p>Use either of the following:</p> <ul style="list-style-type: none"> • "Toyota Super Long Life Coolant" • Similar high-quality ethylene glycol-based non-silicate, non-amine, non-nitrite, and non-borate coolant with long-life hybrid organic acid technology <p>Do not use plain water alone.</p>

Ignition system

Spark plug	
Make	DENSO FK20HBR11
Gap	0.043 in. (1.1 mm)

 NOTICE تلفن شبانه روزی: ۰۸۵-۸۸۶۲۰۸۵-۲۱

■ Iridium-tipped spark plugs

Use only iridium-tipped spark plugs. Do not adjust the spark plug gap.

FarmaSOS.com

Electrical system

Battery	
Open voltage at 68°F (20°C):	12.6 — 12.8 V Fully charged 12.2 — 12.4 V Half charged 11.8 — 12.0 V Discharged (Voltage is checked 20 minutes after the engine and all lights are turned off.)
Charging rates	5 A max.

Automatic transmission

Fluid capacity*	2WD	10.9 qt. (10.3 L, 9.1 Imp. qt.)
	AWD	11.3 qt. (10.7 L, 9.4 Imp. qt.)
Fluid type	Toyota Genuine ATF WS	

*: The fluid capacity is the quantity of reference.

If replacement is necessary, contact your Lexus dealer.

NOTICE

■ Automatic transmission fluid type

Using transmission fluid other than "Toyota Genuine ATF WS" may cause deterioration in shift quality, locking up of your transmission accompanied by vibration, and ultimately damage the transmission of your vehicle.

Transfer (AWD models)

Oil capacity	0.74 qt. (0.7 L, 0.62 Imp. qt.)
Oil type and viscosity*	Toyota Genuine Transfer gear oil LL 80 or equivalent

*: Your Lexus vehicle is filled with Toyota genuine gear oil at the factory. Use Lexus approved Toyota genuine gear oil or an equivalent of matching quality to satisfy the above specification. Please contact your Lexus dealer for further details.

Front differential (AWD models)

Oil capacity	0.79 qt. (0.75 L, 0.66 Imp. qt.)
Oil type and viscosity *	Toyota Genuine Differential gear oil LT 75W-85 GL-5 or equivalent

*: Your Lexus vehicle is filled with “Toyota Genuine Differential Gear Oil” at the factory. Use Lexus approved “Toyota Genuine Differential Gear Oil” or an equivalent of matching quality to satisfy the above specification. Please contact your Lexus dealer for further details.

Rear differential

- ▶ 2WD models (vehicles without paddle shift switches)

Oil capacity	1.42 qt. (1.35 L, 1.19 Imp. qt.)
Oil type and viscosity *	Toyota Genuine Differential gear oil LT 75W-85 GL-5 or equivalent

- ▶ 2WD models (vehicles with paddle shift switches) and AWD models

Oil capacity	1.42 qt. (1.35 L, 1.19 Imp. qt.)
Oil type and viscosity *	Toyota Genuine Differential gear oil LX 75W-85 GL-5 or equivalent

*: Your Lexus vehicle is filled with “Toyota Genuine Differential Gear Oil” at the factory. Use Lexus approved “Toyota Genuine Differential Gear Oil” or an equivalent of matching quality to satisfy the above specification. Please contact your Lexus dealer for further details.

Brakes

Pedal clearance*	5.8 in. (147 mm) Min.
Pedal free play	0.04 - 0.08 in. (1.0 - 2.0 mm)
Brake pad wear limit	0.04 in. (1.0 mm)
Parking brake lining wear limit	0.04 in. (1.0 mm)
Fluid type	SAE J1703 or FMVSS No.116 DOT 3

*: Minimum pedal clearance when depressed with a force of 112 lbf (500 N, 51 kgf) while the engine is running.

When performing the brake pedal inspection, also be sure to check that the brake system warning light is not illuminated when the engine is running (If the brake system warning light is illuminated, refer to P. 504).

Steering

Free play	Less than 1.2 in. (30 mm)
-----------	---------------------------

تلفن شبانه روزی: ۰۲۱-۸۸۶۲۰۸۵

FarmaSOS.com

Tires and wheels

► 18-inch tires (type A)

Tire size	235/50R18 97W
Tire inflation pressure (Recommended cold tire inflation pressure)	<p>Driving under normal conditions</p> <p>Front: 33 psi (230 kPa, 2.3 kgf/cm² or bar) Rear: 33 psi (230 kPa, 2.3 kgf/cm² or bar) Spare: 33 psi (230 kPa, 2.3 kgf/cm² or bar)</p> <p>Driving at high speeds above 100 mph (160 km/h) (in countries where such speeds are permitted by law)</p> <p>Add 9 psi (60 kPa, 0.6 kgf/cm² or bar) to the front tires, 11 psi (70 kPa, 0.7 kgf/cm² or bar) to the rear tires. Never exceed the maximum cold tire inflation pressure indicated on the tire sidewall.</p>
Wheel size	18 × 7 1/2J
Wheel nut torque	103 ft•lbf (140 N•m, 14.3 kgf•m)

► 18-inch tires (type B)

Tire size	P235/50R18 97V
Tire inflation pressure (Recommended cold tire inflation pressure)	<p>Driving under normal conditions</p> <p>Front: 33 psi (230 kPa, 2.3 kgf/cm² or bar) Rear: 33 psi (230 kPa, 2.3 kgf/cm² or bar) Spare: 33 psi (230 kPa, 2.3 kgf/cm² or bar)</p> <p>Driving at high speeds above 100 mph (160 km/h) (in countries where such speeds are permitted by law)</p> <p>Add 6 psi (40 kPa, 0.4 kgf/cm² or bar) to the front tires, 11 psi (70 kPa, 0.7 kgf/cm² or bar) to the rear tires. Never exceed the maximum cold tire inflation pressure indicated on the tire sidewall.</p>
Wheel size	18 × 7 1/2J
Wheel nut torque	103 ft•lbf (140 N•m, 14.3 kgf•m)

► 19-inch tires (type A)

Tire size	245/45R19 98Y
Tire inflation pressure (Recommended cold tire inflation pressure)	<p>Driving under normal conditions Front: 33 psi (230 kPa, 2.3 kgf/cm² or bar) Rear: 33 psi (230 kPa, 2.3 kgf/cm² or bar) Spare: 33 psi (230 kPa, 2.3 kgf/cm² or bar)</p> <p>Driving at high speeds above 100 mph (160 km/h) (in countries where such speeds are permitted by law) Add 9 psi (60 kPa, 0.6 kgf/cm² or bar) to the front tires, 11 psi (70 kPa, 0.7 kgf/cm² or bar) to the rear tires. Never exceed the maximum cold tire inflation pressure indicated on the tire sidewall.</p>
Wheel size	19 × 8J
Wheel nut torque	103 ft•lbf (140 N•m, 14.3 kgf•m)

► 19-inch tires (type B)

Tire size	P245/45R19 98V
Tire inflation pressure (Recommended cold tire inflation pressure)	<p>Driving under normal conditions Front: 33 psi (230 kPa, 2.3 kgf/cm² or bar) Rear: 33 psi (230 kPa, 2.3 kgf/cm² or bar) Spare: 33 psi (230 kPa, 2.3 kgf/cm² or bar)</p> <p>Driving at high speeds above 100 mph (160 km/h) (in countries where such speeds are permitted by law) Add 8 psi (50 kPa, 0.5 kgf/cm² or bar) to the front tires and rear tires. Never exceed the maximum cold tire inflation pressure indicated on the tire sidewall.</p>
Wheel size	19 × 8J
Wheel nut torque	103 ft•lbf (140 N•m, 14.3 kgf•m)

► 19-inch tires (type C)

Tire size	245/45RF19 98Y
Tire inflation pressure (Recommended cold tire inflation pressure)	Driving under normal conditions Front: 36 psi (250 kPa, 2.5 kgf/cm ² or bar) Rear: 36 psi (250 kPa, 2.5 kgf/cm ² or bar) Driving at high speeds (above 100 mph [160 km/h]) (in countries where such speeds are permitted by law) Add 9 psi (60 kPa, 0.6 kgf/cm ² or bar) to the front tires, 10 psi (70 kPa, 0.7 kgf/cm ² or bar) to the rear tires. Never exceed the maximum cold tire inflation pressure indicated on the tire sidewall.
Wheel size	19 × 8J
Wheel nut torque	103 ft•lbf (140 N•m, 14.3 kgf•m)

امداد خودرو فارما

تلفن شبانه روزی: ۰۲۱-۸۸۸۶۲۰۸۵

FarmaSOS.com

Light bulbs

	Light bulbs	Bulb No.	W	Type
Exterior	Headlights (vehicles with discharge headlights)	—	35	A
Interior	Vanity lights	—	8	B
	Front	—	3	C
	Rear	—	3.8	B
	Trunk lid light	—	3.8	B
	Trunk light	—	3.8	B

A: D4S discharge bulbs

B: Wedge base bulbs

C: Double end bulbs

امداد خودرو فارما

تلفن شبانه روزی: ۰۲۱-۸۸۸۶۲۰۸۵

FarmaSOS.com

Fuel information

You must only use unleaded gasoline.

Select premium unleaded gasoline with an octane rating of 91 (Research Octane Number 96) or higher required for optimum engine performance.

If 91 octane cannot be obtained, you may use unleaded gasoline with an octane rating as low as 87 (Research Octane Number 91). Use of unleaded gasoline with an octane rating lower than 91 may result in engine knocking and significantly reduced performance. Persistent knocking can lead to engine damage and should be corrected by refueling with higher octane unleaded gasoline.

At minimum, the gasoline you use should meet the specifications of ASTM D4814 in the U.S.A.

■ Gasoline quality

In very few cases, driveability problems may be caused by the brand of gasoline you are using. If driveability problems persist, try changing the brand of gasoline. If this does not correct the problem, consult your Lexus dealer.

■ Gasoline quality standards

- Automotive manufacturers in the U.S.A., Europe and Japan have developed a specification for fuel quality called the World-Wide Fuel Charter (WWFC), which is expected to be applied worldwide.
- The WWFC consists of four categories that are based on required emission levels. In the U.S., category 4 has been adopted.
- The WWFC improves air quality by lowering emissions in vehicle fleets, and improves customer satisfaction through better performance.

■ Recommendation of the use of gasoline containing detergent additives

- Lexus recommends the use of gasoline that contains detergent additives to avoid the build-up of engine deposits.
- All gasoline sold in the U.S.A. contains minimum detergent additives to clean and/or keep clean intake systems, per EPA's lowest additives concentration program.
- Lexus strongly recommends the use of Top Tier Detergent Gasoline. For more information on Top Tier Detergent Gasoline and a list of marketers, please go to the official website www.toptiergas.com.

■ Recommendation of the use of low emissions gasoline

Gasolines containing oxygenates such as ethers and ethanol, as well as reformulated gasolines, are available in some cities. These fuels are typically acceptable for use, providing they meet other fuel requirements.

Lexus recommends these fuels, since the formulations allow for reduced vehicle emissions.

■ Non-recommendation of the use of blended gasoline

- Use only gasoline containing up to 15% ethanol. DO NOT use any flex-fuel or gasoline that could contain more than 15% ethanol, including from any pump labeled E30, E50, E85 (which are only some examples of fuel containing more than 15% ethanol).

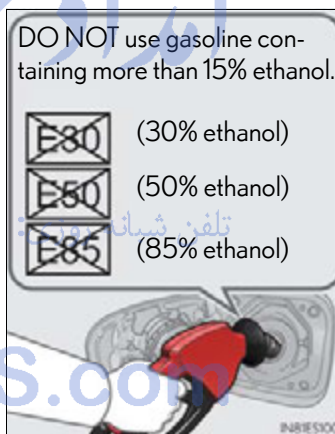

- If you use gasohol in your vehicle, be sure that it has an octane rating no lower than 87.
- Lexus does not recommend the use of gasoline containing methanol.

■ Non-recommendation of the use of gasoline containing MMT

Some gasoline contains an octane enhancing additive called MMT (Methylcyclopentadienyl Manganese Tricarbonyl).

Lexus does not recommend the use of gasoline that contains MMT. If fuel containing MMT is used, your emission control system may be adversely affected.

The malfunction indicator lamp on the instrument cluster may come on. If this happens, contact your Lexus dealer for service.

■ If your engine knocks

- Consult your Lexus dealer.
- You may occasionally notice light knocking for a short time while accelerating or driving uphill. This is normal and there is no need for concern.

NOTICE

■ Notice on fuel quality

- Do not use improper fuels. If improper fuels are used, the engine will be damaged.
- Do not use leaded gasoline.
Leaded gasoline can cause damage to your vehicle's three-way catalytic converters causing the emission control system to malfunction.
- Do not use gasohol other than the type previously stated.
Other gasohol may cause fuel system damage or vehicle performance problems.
- Using unleaded gasoline with an octane number or rating lower than the level previously stated will cause persistent heavy knocking.
At worst, this will lead to engine damage.

■ Fuel-related poor driveability

If poor driveability is encountered after using a different type of fuel (poor hot starting, vaporization, engine knocking, etc.), discontinue the use of that type of fuel.

■ When refueling with gasohol

Take care not to spill gasohol. It can damage your vehicle's paint.

Tire information

Typical tire symbols



- ① Tire size (→P. 568)
- ② DOT and Tire Identification Number (TIN) (→P. 567)
- ③ Location of treadwear indicators (→P. 464)
- ④ Run-flat tire (RFT) or standard tire (→P. 527)

This vehicle can be equipped with either run-flat tires (RFT) or standard tires. An "RFT" or "DSST" mark is molded on the sidewall of the run-flat tire.

- ⑤ Tire ply composition and materials
Plies are layers of rubber-coated parallel cords. Cords are the strands which form the plies in a tire.
- ⑥ Radial tires or bias-ply tires
A radial tire has "RADIAL" on the sidewall. A tire not marked "RADIAL" is a bias-ply tire.
- ⑦ TUBELESS or TUBE TYPE
A tubeless tire does not have a tube and air is directly put into the tire. A tube type tire has a tube inside the tire and the tube maintains the air pressure.
- ⑧ Load limit at maximum cold tire inflation pressure (→P. 572)

- ⑨ Maximum cold tire inflation pressure (→P. 572)
This means the pressure to which a tire may be inflated.
- ⑩ Uniform tire quality grading
For details, see “Uniform Tire Quality Grading” that follows.
- ⑪ Summer tires or all season tires (→P. 469)
An all season tire has “M+S” on the sidewall. A tire not marked “M+S” is a summer tire.

Typical DOT and Tire Identification Number (TIN)

- ① DOT symbol*
- ② Tire Identification Number (TIN)
- ③ Tire manufacturer's identification mark
- ④ Tire size code
- ⑤ Manufacturer's optional tire type code (3 or 4 letters)
- ⑥ Manufacturing week
- ⑦ Manufacturing year

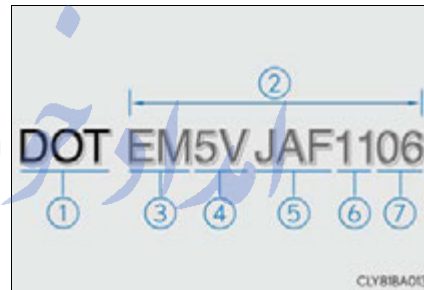

*: The DOT symbol certifies that the tire conforms to applicable Federal Motor Vehicle Safety Standards.

Tire size

■ Typical tire size information

The illustration indicates typical tire size.

- ① Tire use (P = Passenger car, T = Temporary use)
- ② Section width (millimeters)
- ③ Aspect ratio (tire height to section width)
- ④ Tire construction code (R = Radial, D = Diagonal)
- ⑤ Wheel diameter (inches)
- ⑥ Load index (2 digits or 3 digits)
- ⑦ Speed symbol (alphabet with one letter)
- ⑧ Run-flat tire code

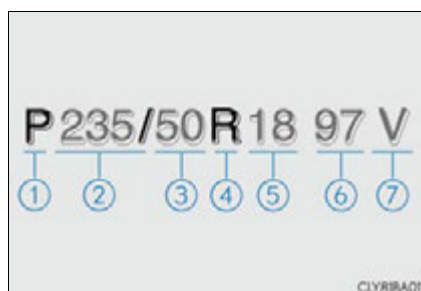

■ Tire dimensions

- ① Section width
- ② Tire height
- ③ Wheel diameter



Tire section names

- ① Bead
- ② Sidewall
- ③ Shoulder
- ④ Tread
- ⑤ Belt
- ⑥ Inner liner
- ⑦ Reinforcing rubber
- ⑧ Carcass
- ⑨ Rim lines
- ⑩ Bead wires
- ⑪ Chafer

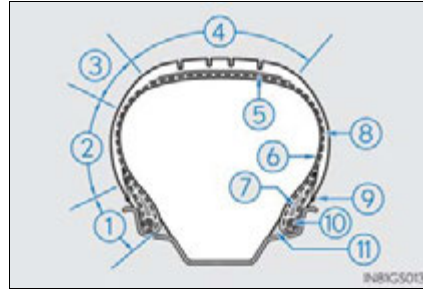

تلفن شبانه روزی: ۰۲۱-۸۸۸۶۲۰۸۵

FarmaSOS.com

Uniform Tire Quality Grading

This information has been prepared in accordance with regulations issued by the National Highway Traffic Safety Administration of the U.S. Department of Transportation.

It provides the purchasers and/or prospective purchasers of Lexus vehicles with information on uniform tire quality grading.

Your Lexus dealer will help answer any questions you may have as you read this information.

■ DOT quality grades

All passenger vehicle tires must conform to Federal Safety Requirements in addition to these grades. Quality grades can be found where applicable on the tire sidewall between tread shoulder and maximum section width.

For example: Treadwear 200 Traction AA Temperature A

■ Treadwear

The treadwear grade is a comparative rating based on the wear rate of the tire when tested under controlled conditions on a specified government test course.

For example, a tire graded 150 would wear one and a half (1 - 1/2) times as well on the government course as a tire graded 100.

The relative performance of tires depends upon the actual conditions of their use. Performance may differ significantly from the norm due to variations in driving habits, service practices and differences in road characteristics and climate.

■ Traction AA, A, B, C

The traction grades, from highest to lowest, are AA, A, B and C, and they represent the tire's ability to stop on wet pavement as measured under controlled conditions on specified government test surfaces of asphalt and concrete.

A tire marked C may have poor traction performance.

Warning: The traction grade assigned to this tire is based on braking (straight ahead) traction tests and does not include cornering (turning) traction.

■ Temperature A, B, C

The temperature grades are A (the highest), B, and C, representing the tire's resistance to the generation of heat and its ability to dissipate heat when tested under controlled conditions on a specified indoor laboratory test wheel.

Sustained high temperature can cause the material of the tire to degenerate and reduce tire life, and excessive temperature can lead to sudden tire failure.

Grade C corresponds to a level of performance which all passenger car tires must meet under the Federal Motor Vehicle Safety Standard No. 109.

Grades B and A represent higher levels of performance on the laboratory test wheel than the minimum required by law.

Warning: The temperature grades of a tire assume that it is properly inflated and not overloaded.

Excessive speed, underinflation, or excessive loading, either separately or in combination, can cause heat buildup and possible tire failure.

تلفن شبانه روزی: ۰۲۱-۸۸۸۶۲۰۸۵

FarmaSOS.com

Glossary of tire terminology

Tire related term	Meaning
Cold tire inflation pressure	Tire pressure when the vehicle has been parked for three hours or more, or has not been driven more than 1 mile or 1.5 km under that condition
Maximum inflation pressure	The maximum cold inflated pressure to which a tire may be inflated, shown on the sidewall of the tire
Recommended inflation pressure	Cold tire inflation pressure recommended by a manufacturer
Accessory weight	The combined weight (in excess of those standard items which may be replaced) of automatic transmission, power steering, power brakes, power windows, power seats, radio and heater, to the extent that these items are available as factory-installed equipment (whether installed or not)
Curb weight	The weight of a motor vehicle with standard equipment, including the maximum capacity of fuel, oil and coolant, and if so equipped, air conditioning and additional weight optional engine
Maximum loaded vehicle weight	The sum of: (a) Curb weight (b) Accessory weight (c) Vehicle capacity weight (d) Production options weight
Normal occupant weight	150 lb. (68 kg) times the number of occupants specified in the second column of Table 1* that follows
Occupant distribution	Distribution of occupants in a vehicle as specified in the third column of Table 1* below
Production options weight	The combined weight of installed regular production options weighing over 5 lb. (2.3 kg) in excess of the standard items which they replace, not previously considered in curb weight or accessory weight, including heavy duty brakes, ride levelers, roof rack, heavy duty battery, and special trim
Rim	A metal support for a tire or a tire and tube assembly upon which the tire beads are seated

Tire related term	Meaning
Rim diameter (Wheel diameter)	Nominal diameter of the bead seat
Rim size designation	Rim diameter and width
Rim type designation	The industry manufacturer's designation for a rim by style or code
Rim width	Nominal distance between rim flanges
Vehicle capacity weight (Total load capacity)	The rated cargo and luggage load plus 150 lb. (68 kg) times the vehicle's designated seating capacity
Vehicle maximum load on the tire	The load on an individual tire that is determined by distributing to each axle its share of the maximum loaded vehicle weight, and dividing by two
Vehicle normal load on the tire	The load on an individual tire that is determined by distributing to each axle its share of curb weight, accessory weight, and normal occupant weight (distributed in accordance with Table 1* below), and dividing by two
Weather side	The surface area of the rim not covered by the inflated tire
Bead	The part of the tire that is made of steel wires, wrapped or reinforced by ply cords and that is shaped to fit the rim
Bead separation	A breakdown of the bond between components in the bead
Bias ply tire	A pneumatic tire in which the ply cords that extend to the beads are laid at alternate angles substantially less than 90 degrees to the centerline of the tread
Carcass	The tire structure, except tread and sidewall rubber which, when inflated, bears the load
Chunking	The breaking away of pieces of the tread or sidewall
Cord	The strands forming the plies in the tire
Cord separation	The parting of cords from adjacent rubber compounds
Cracking	Any parting within the tread, sidewall, or innerliner of the tire extending to cord material

Tire related term	Meaning
CT	A pneumatic tire with an inverted flange tire and rim system in which the rim is designed with rim flanges pointed radially inward and the tire is designed to fit on the underside of the rim in a manner that encloses the rim flanges inside the air cavity of the tire
Extra load tire	A tire designed to operate at higher loads and at higher inflation pressures than the corresponding standard tire
Groove	The space between two adjacent tread ribs
Innerliner	The layer(s) forming the inside surface of a tubeless tire that contains the inflating medium within the tire
Innerliner separation	The parting of the innerliner from cord material in the carcass
Intended outboard sidewall	(a) The sidewall that contains a whitewall, bears white lettering, or bears manufacturer, brand, and/or model name molding that is higher or deeper than the same molding on the other sidewall of the tire, or (b) The outward facing sidewall of an asymmetrical tire that has a particular side that must always face outward when mounted on a vehicle
Light truck (LT) tire	A tire designated by its manufacturer as primarily intended for use on lightweight trucks or multipurpose passenger vehicles
Load rating	The maximum load that a tire is rated to carry for a given inflation pressure
Maximum load rating	The load rating for a tire at the maximum permissible inflation pressure for that tire
Maximum permissible inflation pressure	The maximum cold inflation pressure to which a tire may be inflated
Measuring rim	The rim on which a tire is fitted for physical dimension requirements
Open splice	Any parting at any junction of tread, sidewall, or innerliner that extends to cord material
Outer diameter	The overall diameter of an inflated new tire

Tire related term	Meaning
Overall width	The linear distance between the exteriors of the sidewalls of an inflated tire, including elevations due to labeling, decorations, or protective bands or ribs
Passenger car tire	A tire intended for use on passenger cars, multipurpose passenger vehicles, and trucks, that have a gross vehicle weight rating (GVWR) of 10,000 lb. or less.
Ply	A layer of rubber-coated parallel cords
Ply separation	A parting of rubber compound between adjacent plies
Pneumatic tire	A mechanical device made of rubber, chemicals, fabric and steel or other materials, that, when mounted on an automotive wheel, provides the traction and contains the gas or fluid that sustains the load
Radial ply tire	A pneumatic tire in which the ply cords that extend to the beads are laid at substantially 90 degrees to the centerline of the tread
Reinforced tire	A tire designed to operate at higher loads and at higher inflation pressures than the corresponding standard tire
Section width	The linear distance between the exteriors of the sidewalls of an inflated tire, excluding elevations due to labeling, decoration, or protective bands
Sidewall	That portion of a tire between the tread and bead
Sidewall separation	The parting of the rubber compound from the cord material in the sidewall
Snow tire	A tire that attains a traction index equal to or greater than 110, compared to the ASTM E-1136 Standard Reference Test Tire, when using the snow traction test as described in ASTM F-1805-00, Standard Test Method for Single Wheel Driving Traction in a Straight Line on Snow-and Ice-Covered Surfaces, and which is marked with an Alpine Symbol () on at least one sidewall
Test rim	The rim on which a tire is fitted for testing, and may be any rim listed as appropriate for use with that tire

Tire related term	Meaning
Tread	That portion of a tire that comes into contact with the road
Tread rib	A tread section running circumferentially around a tire
Tread separation	Pulling away of the tread from the tire carcass
Treadwear indicators (TWI)	The projections within the principal grooves designed to give a visual indication of the degrees of wear of the tread
Wheel-holding fixture	The fixture used to hold the wheel and tire assembly securely during testing

*: Table 1 — Occupant loading and distribution for vehicle normal load for various designated seating capacities



Designated seating capacity, Number of occupants	Vehicle normal load, Number of occupants	Occupant distribution in a normally loaded vehicle
2 through 4	2	2 in front
5 through 10	3	2 in front, 1 in second seat
11 through 15	5	2 in front, 1 in second seat, 1 in third seat, 1 in fourth seat
16 through 20	7	2 in front, 2 in second seat, 2 in third seat, 1 in fourth seat

Customizable features

Your vehicle includes a variety of electronic features that can be personalized to your preferences. These preferences can be changed by using the “DISP” button, by using the Remote Touch, or at your Lexus dealer.

Customizing vehicle features

■ Changing by using the Remote Touch

- 1 Press the “MENU” button on the Remote Touch.
- 2 Select  on the “Menu” screen and select .

Various setting can be changed. Refer to the list of settings that can be changed for details.

■ Changing by using the “DISP” button

→P. 99

تلفن شبانه روزی: ۰۲۱-۸۸۸۶۲۰۸۵

FarmaSOS.com

Customizable features

Some function settings are changed simultaneously with other functions being customized. Contact your Lexus dealer for further details.

- ① Settings that can be changed using the Remote Touch
- ② Settings that can be changed using the “DISP” button
- ③ Settings that can be changed by your Lexus dealer

Definition of symbols: ○ = Available, – = Not available

Item	Function	Default setting	Customized setting	①	②	③
Multi-information display (→P. 94)	Language	American English	French	–	○	○
			Spanish	–	○	○
	Units*2	miles (MPG)	km (km/L)	–	○	○
			km (L/100km)	–	○	○
	ECO lamp	ON (Self-lighting)	OFF	–	○	○
			ON (Always)	–	○	○
	Drive monitor	Cruising range	Fuel consumption	–	○	○
	Lamp brightness	Standard	Bright	–	○	○
SPORT lamp	ON	OFF	–	○	○	
Background screen	ON	OFF	–	○	○	
Default settings	OFF	ON	–	○	○	

Item	Function	Default setting	Customized setting	①	②	③	
Door lock (→P. 133, 536)	Unlocking using mechanical key	Driver's door unlocked in one step, all doors unlocked in two steps	All doors unlocked in one step	-	-	○	
	Automatic door lock	Shifting the shift lever to position other than P	Off				
			Vehicle speed is approximately 12 mph (20 km/h) or higher	○	-	○	
Automatic door unlock	Shifting the shift lever to P	Off					
		Driver's door is opened	○	-	○		
Smart access system with push-button start (→P. 113) and wireless remote control (→P. 129)	Operation buzzer volume	7	Off	○	-	○	
			1 to 6				
	Operational signal (Emergency flashers)	On	Off	○	-	○	
	Time elapsed before automatic lock function is activated if door is not opened after being unlocked	60 seconds	Off				
			30 seconds	○	-	○	
120 seconds							
Open door warning buzzer	On	Off	-	-	○		

Item	Function	Default setting	Customized setting	①	②	③
Smart access system with push-button start (→P.113)	Smart access system with push-button start	On	Off	○	–	○
	Smart door unlocking	Driver's door	All the doors	○	–	○
			Each door			
			Same side doors			
	Welcome light illumination control	On	Off	–	–	○
Opening trunk without the electronic key when all doors are unlocked	On	Off	–	–	○	
Wireless remote control (→P.129)	Wireless remote control	On	Off	–	–	○
	Unlocking operation	Driver's door unlocked in one step, all doors unlocked in two steps	All doors unlocked in one step	○	–	○
			Trunk unlocking operation			
	Trunk unlocking operation	One long press	One short press	–	–	○
Push twice						
			Off			

Item	Function	Default setting	Customized setting	①	②	③
Front seats (→P.144)	Driver's seat movement when exiting the vehicle	Standard	Off	○	-	○
			Partial			
	Driver's seat lumbar support movement when exiting the vehicle	On	Off	-	-	○
	Front passenger's seat lumbar support firmness adjustment when exiting the vehicle	On	Off	-	-	○
	Upward movement of entire front passenger seat during stowage when the seat is stowed by using the front passenger seat operation AUTO switch on front console or the front passenger seat operation AUTO button on the rear armrest*1	On	Off	-	-	○
Power windows (→P.181) and moon roof (→P.185)	One-touch close operation using the power window switches on the front passenger door and each rear door	On	Off	-	-	○
	One-touch front passenger window or rear window close operation using the power window switch on the driver's door	On	Off	-	-	○
	Mechanical key linked operation	On	Off	-	-	○
	Wireless remote control linked operation	Off	On (Open only)	-	-	○
	Linked entry function	On	Off	-	-	○

Item	Function	Default setting	Customized setting	①	②	③
Turn signal lever (→P. 224)	Times of flashing of the lane change signal flashers	3	5	○	-	○
			7			
			9			
			11			
			Off			
Automatic light control system (→P. 231)	Light sensor sensitivity	Standard	-2 to 2	○	-	○
	Time elapsed before headlights automatically turn off after doors are closed	30 seconds	Off	○	-	○
			60 seconds			
90 seconds						
AFS (Adaptive Front-lighting System) (→P. 232)	Adaptive Front-lighting System	On	Off	-	-	○
Lights (→P. 231)	Daytime running light system ^{*3}	On	Off	○	-	○
Intuitive parking assist ^{*4}	Detection distance of the front center sensor	Far	Near	○	-	○
	Detection distance of the rear center sensor	Far	Near	○	-	○
	Buzzer volume	3	1 to 5	○	-	○
	Display setting (when intuitive parking assist is operating)	All sensors displayed	Display off	○	-	○

Item	Function	Default setting	Customized setting	①	②	③
Automatic air conditioning system (→P. 334)	A/C Auto switch operation	On	Off	○	–	○
	Exhaust gas sensor sensitivity	Standard	-3 to 3	○	–	○
	Air conditioning control of Eco drive mode	On	Off	–	–	○
Climate control seats ^{*1} /seat heaters ^{*1} (→P. 394)	Front climate control seat/seat heater temperature adjustment during automatic operation (individual seat adjustment available)	Level 3 (standard)	Level 1 (cool) to level 5 (warm)	○	–	○
	Rear climate control seat/rear seat heater start-up conditions when engine switch is in the ON position (individual seat adjustment available)	Off	On (AUTO)	○	–	○
	Function that warms seats faster than usual (individual seat adjustment available)	On	Off	–	–	○
	Time until function that warms seats faster than usual turns off (individual seat adjustment available)	Standard	Short Long	–	–	○
Heated steering wheel ^{*1} (→P. 392)	Automatic steering wheel heating	On	Off	○	–	○
	Time until automatic steering wheel heating turns off	Level 3 (standard)	Level 1 (short) to level 5 (long)	○	–	○

Item	Function	Default setting	Customized setting	①	②	③
Illumination (→P. 361)	Time elapsed before the interior lights turn off	15 seconds	Off			
			7.5 seconds	○	–	○
			30 seconds			
	Operation after the engine switch is turned off	On	Off	–	–	○
	Operation when the doors are unlocked	On	Off	–	–	○
	Operation when you approach the vehicle with the electronic key on your person	On	Off	–	–	○
	Footwell and inside door handle lights	On	Off	–	–	○
	Shift lever light	On	Off	–	–	○
	Seat belt buckle illumination when driver's door is opened	On	Off	–	–	○
	Seat belt buckle illumination after the engine switch is turned off	On	Off	–	–	○
	Instrument panel illumination method	Choreographed illumination	Simple illumination	–	–	○
			Off			
	Exterior light control	On	Off	–	–	○
Time elapsed before the outer foot lights turn off	15 seconds	Off				
		7.5 seconds	○	–	○	
		30 seconds				

Item	Function	Default setting	Customized setting	①	②	③
Illumination (→P. 361)	Operation of the outer foot lights when you approach the vehicle with the electronic key on your person	On	Off	-	-	○
	Operation of the outer foot lights when the doors are unlocked with the power door lock switch	On	Off	-	-	○
Seat belt reminder (→P. 507)	Vehicle speed linked seat belt reminder buzzer	On	Off	-	-	○

*1: If equipped

*2: The default setting varies according to countries.

*3: U.S.A. only

*4: Refer to "NAVIGATION AND MULTIMEDIA SYSTEM OWNER'S MANUAL".

■ Vehicle customization

- When the smart access system with push-button start is off, the entry unlock function cannot be customized.
- When the doors remain closed after unlocking the doors and the timer activated automatic door lock function activates, signals will be generated in accordance with the operation buzzer volume and operational signal (Emergency flashers) function settings.

■ When customizing using the Remote Touch

Stop the vehicle in a safe place, apply the parking brake, and shift the shift lever to P. Also, to prevent battery discharge, leave the engine running while customizing the features.

⚠ CAUTION

■ During customization

As the engine needs to be running during customization, ensure that the vehicle is parked in a place with adequate ventilation. In a closed area such as a garage, exhaust gases including harmful carbon monoxide (CO) may collect and enter the vehicle. This may lead to death or a serious health hazard.

 NOTICE

■ During customization

To prevent battery discharge, ensure that the engine is running while customizing features.

امداد خودرو فارما

تلفن شبانه روزی: ۰۲۱-۸۸۸۶۲۰۸۵

FarmaSOS.com

Reporting safety defects for U.S. owners.....	588
Seat belt instructions for Canadian owners (in French).....	589
SRS airbag instructions for Canadian owners (in French).....	591
Headlight aim instructions for Canadian owners (in French).....	600

امداد خودرو فارما

تلفن شبانه روزی: ۰۲۱-۸۸۸۶۲۰۸۵

FarmaSOS.com

Reporting safety defects for U.S. owners

If you believe that your vehicle has a defect which could cause a crash or could cause injury or death, you should immediately inform the National Highway Traffic Safety Administration (NHTSA) in addition to notifying the Lexus Division of Toyota Motor Sales, U.S.A., Inc. (Toll-free: 1-800-25-LEXUS).

If NHTSA receives similar complaints, it may open an investigation, and if it finds that a safety defect exists in a group of vehicles, it may order a recall and remedy campaign. However, NHTSA cannot become involved in individual problems between you, your dealer, or Lexus Division of Toyota Motor Sales, U.S.A., Inc.

To contact NHTSA, you may call the Vehicle Safety Hotline toll-free at 1-888-327-4236 (TTY: 1-800-424-9153); go to <http://www.safercar.gov>; or write to: Administrator, NHTSA, 1200 New Jersey Ave, S.E., Washington, DC 20590. You can also obtain other information about motor vehicle safety from <http://www.safercar.gov>.

تلفن شبانه روزی: ۰۲۱-۸۸۸۶۲۰۸۵

FarmaSOS.com

Seat belt instructions for Canadian owners (in French)

The following is a French explanation of seat belt instructions extracted from the seat belt section in this manual.

See the seat belt section for more detailed seat belt instructions in English.

Utilisation correcte des ceintures de sécurité

- Déroulez la sangle diagonale de telle sorte qu'elle passe bien sur l'épaule, sans pour autant être en contact avec le cou ou glisser de l'épaule.
- Placez la sangle abdominale le plus bas possible sur les hanches.
- Réglez la position du dossier de siège. Asseyez-vous le dos le plus droit possible et calez-vous bien dans le siège.
- Ne vrillez pas la ceinture de sécurité.

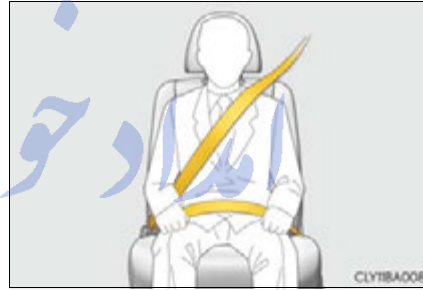

Guide de confort de ceinture de sécurité (sièges arrière latéraux)

Pour les enfants en bas âge ou les personnes plus petites que la moyenne, faites coulisser le guide de confort de ceinture de sécurité vers l'avant afin que la ceinture diagonale ne se positionne pas à proximité du cou de la personne.

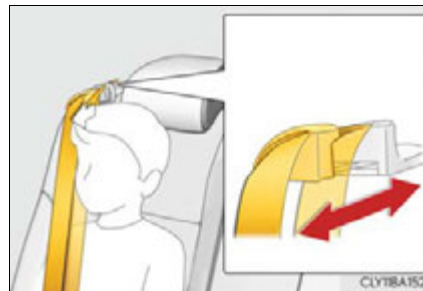

Entretien et soin

■ Ceintures de sécurité

Nettoyez avec un chiffon ou une éponge humectée d'eau savonneuse tiède. Vérifiez régulièrement que les ceintures ne sont pas effilochées, entaillées ou exagérément usées.

⚠ ATTENTION

■ Détérioration et usure des ceintures de sécurité

Inspectez le système des ceintures de sécurité périodiquement. Contrôlez que les ceintures ne sont pas entaillées, effilochées et que leurs ancrages ne sont pas desserrés. N'utilisez pas une ceinture de sécurité défectueuse avant qu'elle ne soit remplacée. Une ceinture de sécurité défectueuse n'apporte aucune garantie de protection de l'occupant en cas d'accident.

امداد خودرو فارما
تلفن شبانه روزی: ۰۲۱-۸۸۸۶۲۰۸۵

FarmaSOS.com

SRS airbag instructions for Canadian owners (in French)

The following is a French explanation of SRS airbag instructions extracted from the SRS airbag section in this manual.

See the SRS airbag section for more detailed SRS airbag instructions in English.

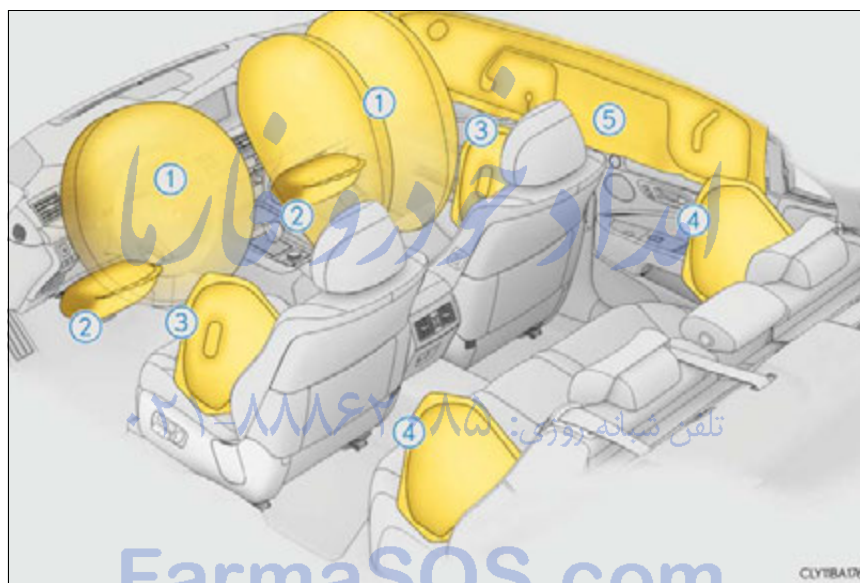

◆ Coussins gonflables avant SRS

- ① Coussin gonflable conducteur SRS/coussin gonflable passager avant
Participent à la protection de la tête et du thorax du conducteur et du passager avant contre les chocs avec les éléments de l'habitacle
- ② Coussins gonflables de genoux SRS
Participent à la protection du conducteur et du passager avant

◆ Coussins gonflables latéraux et rideaux SRS

- ③ Coussins gonflables latéraux avant SRS
Peuvent aider à protéger le torse des passagers avant
- ④ Coussins gonflables latéraux arrière SRS (sur modèles équipés)
Participent à la protection du haut du corps des occupants assis aux places arrière extérieures
- ⑤ Coussins gonflables rideau SRS
Participent principalement à la protection de la tête des occupants assis aux places extérieures

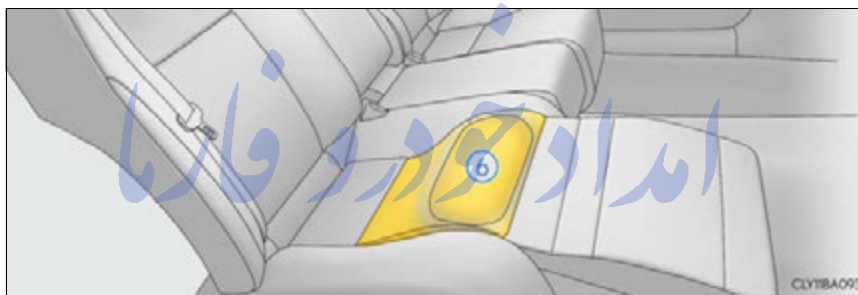

- ⑥ Coussins gonflables d'assise arrière SRS (avec siège de relaxation)
Contribue à retenir le passager assis dans le siège de relaxation

FarmaSOS.com

Composition du système de coussins gonflables SRS

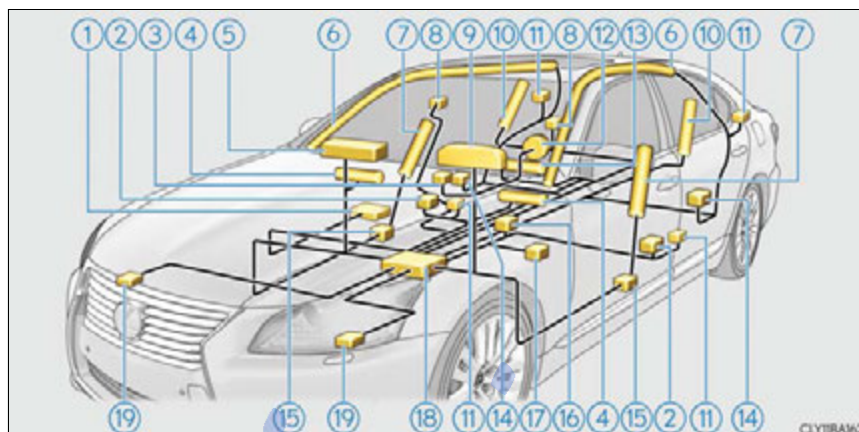

- | | |
|---|--|
| ① Système de classification de l'occupant du siège passager avant (ECU et capteurs) | ⑪ Prétensionneurs de ceintures de sécurité et limiteurs de force |
| ② Capteurs d'impact latéral (avant) | ⑫ Coussin gonflable conducteur |
| ③ Témoins indicateurs "AIR BAG ON" et "AIR BAG OFF" | ⑬ Coussin gonflable d'assise (sur modèles équipés) |
| ④ Coussins gonflables de genoux | ⑭ Capteurs d'impact latéral (arrière) |
| ⑤ Coussin gonflable passager avant | ⑮ Capteurs d'impact latéral (porte avant) |
| ⑥ Coussins gonflables rideaux | ⑯ Commande de boucle de ceinture de sécurité conducteur |
| ⑦ Coussins gonflables latéraux avant | ⑰ Capteur de position du siège conducteur |
| ⑧ Appuis-tête actifs | ⑱ Boîtier électronique des coussins gonflables |
| ⑨ Témoin d'avertissement SRS | ⑲ Capteurs d'impact avant |
| ⑩ Coussins gonflables latéraux arrière (sur modèles équipés) | |

Votre véhicule est équipé de COUSSINS GONFLABLES INTELLIGENTS conçus selon les normes de sécurité américaines applicables aux véhicules à moteur (FMVSS208). Le boîtier électronique (ECU) des coussins gonflables régule le déploiement de ces derniers sur la base des informations qu'il reçoit des capteurs, etc., indiqués ci-dessus dans le schéma illustrant les composants du système. Parmi ces informations figurent la gravité du choc et l'occupation du véhicule par les passagers. Le déploiement rapide des coussins gonflables est obtenu au moyen d'une réaction chimique dans les dispositifs pyrotechniques, qui produit un gaz inoffensif permettant d'amortir le mouvement des occupants.

امداد خودرو فارما

تلفن شبانه روزی: ۰۲۱-۸۸۸۶۲۰۸۵

FarmaSOS.com

⚠ ATTENTION**■ Précautions avec les coussins gonflables SRS**

Respectez les précautions suivantes avec les coussins gonflables SRS. Autrement, des blessures graves, voire mortelles, pourraient s'ensuivre.

- Le conducteur et tous les passagers à bord du véhicule doivent porter leur ceinture de sécurité correctement. Les coussins gonflables SRS sont des dispositifs supplémentaires à utiliser avec les ceintures de sécurité.
- Le coussin gonflable conducteur SRS se déploie avec une violence considérable, qui peut être très dangereuse, voire mortelle, si le conducteur se trouve très près du coussin gonflable. La National Highway Traffic Safety Administration (NHTSA) conseille:

Sachant que la zone de danger pour le coussin gonflable conducteur se trouve dans les premiers 2 à 3 in. (50 - 75 mm) de déploiement, vous placer à 10 in. (250 mm) de votre coussin gonflable conducteur vous garantit une marge de sécurité suffisante. Cette distance est à mesurer entre l'axe du volant et le sternum. Si vous êtes assis à moins de 10 in. (250 mm), vous pouvez changer votre position de conduite de plusieurs façons:

- Reculez votre siège le plus possible, de manière à pouvoir encore atteindre confortablement les pédales.
- Inclinez légèrement le dossier du siège. Bien que les véhicules puissent être différents les uns des autres, la plupart des conducteurs peuvent s'asseoir à une distance de 10 in. (250 mm), même avec le siège conducteur complètement avancé, simplement en inclinant un peu le dossier de siège. Si vous avez des difficultés à voir la route après avoir incliné votre siège, utilisez un coussin ferme et antidérapant pour vous rehausser ou, si votre véhicule est équipé du réglage en hauteur du siège, remontez-le.
- Si votre volant est réglable, inclinez-le vers le bas. Cela a pour effet d'orienter le coussin gonflable en direction de votre poitrine plutôt que de votre tête et de votre cou.

Régalez votre siège selon ces recommandations de la NHTSA, tout en conservant le contrôle des pédales, du volant et la vue des commandes du tableau de bord.

⚠ ATTENTION

■ **Précautions avec les coussins gonflables SRS**

● Si vous attachez une rallonge de ceinture de sécurité aux boucles de ceinture de sécurité du siège avant, mais pas au pêne de la ceinture de sécurité, les coussins gonflables avant SRS détectent que le conducteur et le passager avant ont attaché leur ceinture de sécurité, alors même que ce n'est pas le cas. Dans ce cas, il se peut que les coussins gonflables avant SRS ne se déploient pas correctement en cas d'accident et vous risquez d'être tué ou grièvement blessé. Veillez à porter la ceinture de sécurité avec la rallonge de ceinture de sécurité.



● Le coussin gonflable passager avant SRS se déploie également avec une violence considérable, qui peut être très dangereuse, voire mortelle, si le passager avant se trouve très près du coussin gonflable. Éloignez le siège du passager avant au maximum du coussin gonflable et réglez le dossier de siège de façon à être assis bien droit dans le siège.

● Les nourrissons et les enfants qui ne sont pas correctement assis et/ou protégés peuvent être grièvement blessés ou tués par le déploiement d'un coussin gonflable. Installez dans un siège de sécurité enfant les enfants trop jeunes pour pouvoir utiliser la ceinture de sécurité. Lexus recommande vivement d'installer tous les nourrissons et enfants aux sièges arrière du véhicule et de prévoir pour eux des systèmes de retenue adaptés. Les sièges arrière sont plus sûrs pour les nourrissons et les enfants que le siège du passager avant.

● N'installez jamais un siège de sécurité enfant type dos à la route sur le siège du passager avant, même si le témoin indicateur "AIR BAG OFF" est allumé. En cas d'accident, par la violence et la vitesse de son déploiement, le coussin gonflable passager avant peut blesser grièvement, voire tuer l'enfant si le siège de sécurité enfant type dos à la route est installé sur le siège du passager avant.

● Ne vous asseyez pas sur le bord du siège et ne vous appuyez pas contre la planche de bord.



⚠ ATTENTION

■ Précautions avec les coussins gonflables SRS

- Ne laissez pas un enfant rester debout devant le coussin gonflable passager avant SRS ou bien s'asseoir sur les genoux du passager avant.
- Ne laissez pas les occupants des sièges avant voyager avec un objet sur les genoux.
- Ne vous appuyez pas contre la porte, contre le rail latéral de toit ou contre les montants avant, latéraux et arrière.
- Ne laissez personne s'agenouiller sur les sièges passagers en appui contre la porte ou sortir la tête ou les mains à l'extérieur du véhicule.
- Ne fixez ni ne posez aucun objet sur le tableau de bord, la garniture du volant de direction et la partie inférieure du tableau de bord.
Au déploiement des coussins gonflables conducteur SRS, passager avant et genoux, tout objet risque de se transformer en projectile.
- Ne rien fixer aux portes, à la vitre de pare-brise, aux vitres latérales, aux montants avant et arrière, au rail latéral de toit et à la poignée de maintien.

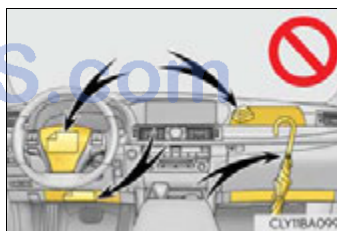

تلفن شیکه روزی: ۰۲۱-۸۸۶۲۰۸۵

⚠ ATTENTION**■ Précautions avec les coussins gonflables SRS**

- Ne suspendez aucun cintre ni objet dur aux crochets à vêtements. En cas de déploiement des coussins gonflables rideaux SRS, tous ces objets pourraient se transformer en projectiles et causer des blessures graves, voire mortelles.
- Si un cache en vinyle recouvre la partie où le coussin gonflable de genoux SRS se déploie, veillez à l'enlever.
- N'utilisez pour les sièges aucun accessoire venant recouvrir les zones de déploiement des coussins gonflables latéraux SRS et du coussin gonflable d'assise arrière SRS, car il risquerait de gêner le déploiement des coussins gonflables SRS. De tels accessoires peuvent empêcher les coussins gonflables latéraux et le coussin gonflable d'assise de fonctionner correctement, désactiver le dispositif ou entraîner le déploiement accidentel des coussins gonflables latéraux et du coussin gonflable d'assise, entraînant la mort ou des blessures graves.
- Évitez de faire subir des chocs ou des pressions excessives aux zones renfermant les composants des coussins gonflables SRS. En effet, cela pourrait entraîner un fonctionnement anormal des coussins gonflables SRS.
- Ne touchez aucun composant du système immédiatement après le déploiement (gonflage) des coussins gonflables SRS, car ils peuvent être chauds.
- Si vous avez des difficultés à respirer après le déploiement des coussins gonflables SRS, ouvrez une porte ou une vitre pour faire entrer de l'air frais, ou bien descendez du véhicule si cela ne présente pas de danger. Essayez tout résidu dès que possible afin d'éviter d'éventuelles irritations de la peau.
- Si les parties renfermant les coussins gonflables SRS, telles que la garniture du moyeu de volant et les garnitures de montants avant et arrière, apparaissent abîmées ou craquelées, faites-les remplacer par votre concessionnaire Lexus.
- Ne placez rien sur le siège du passager avant, comme un coussin par exemple. Cela a pour conséquence de répartir le poids du passager sur toute la surface du siège, ce qui empêche le capteur de détecter correctement le poids du passager. En conséquence, le coussin gonflable passager avant SRS risque de ne pas se déployer en cas de choc.

⚠ ATTENTION

■ Modification et mise au rebut des éléments du système de coussins gonflables SRS

Consultez impérativement votre concessionnaire Lexus si vous avez besoin d'intervenir sur votre véhicule ou de procéder à l'une des modifications suivantes. Les coussins gonflables SRS peuvent être défaillants ou se déployer (se gonfler) accidentellement, provoquant la mort ou de graves blessures.

- Installation, dépose, démontage et réparation des coussins gonflables SRS
- Réparations, modifications, démontage ou remplacement du volant, du tableau de bord, de la planche de bord, des sièges ou de leur garnissage, des montants avant, latéraux et arrière ou des rails latéraux de toit
- Réparations ou modifications des ailes avant, du bouclier avant ou des flancs de l'habitacle
- Installation d'un protège-calandre (pare-buiffe, pare-kangourou, etc.), de chasse-neige, de treuils
- Modifications du système de suspension du véhicule
- Installation d'appareils électroniques, tels qu'une radio émetteur/récepteur ou un lecteur CD
- Aménagements du véhicule visant à permettre sa conduite par une personne atteinte d'un handicap physique

FarmaSOS.com

Headlight aim instructions for Canadian owners (in French)

The following is a French explanation of headlight aim instructions from the headlight aim section in this manual.

Dépose de l'habillage du compartiment moteur

► Extérieur



► Avant

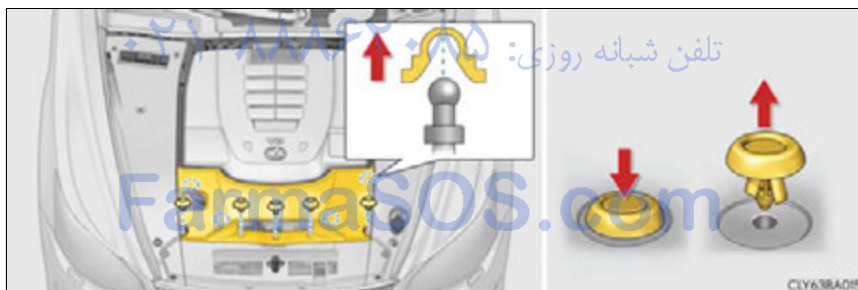

Vis de réglage dans l'axe vertical

- ① Boulon de réglage A
- ② Boulon de réglage B

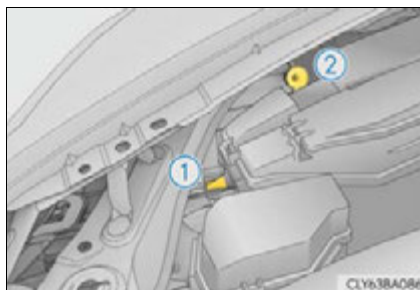

Avant de vérifier le réglage du faisceau des phares

- 1 Assurez-vous que le véhicule est doté d'un réservoir d'essence complet et que la zone située autour des feux avant n'est pas déformée.
- 2 Garez le véhicule sur un sol à plat.
- 3 Asseyez-vous sur le siège conducteur.
- 4 Sauter à plusieurs reprises le véhicule.

Réglage du faisceau des phares

- 1 À l'aide d'un tournevis cruciforme, tournez le boulon dans n'importe quel sens.

Mémo­ri­sez le sens dans lequel vous avez tourné et le nombre de tours.

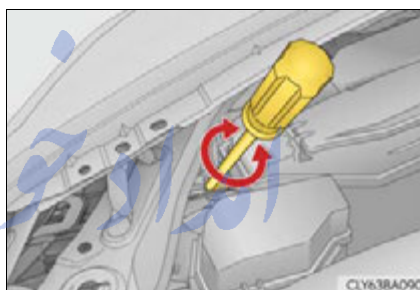

- 2 Tournez le boulon B du même nombre de tours dans le même sens qu'à l'étape 1.

Si vous n'arrivez pas à régler le projecteur en procédant de la sorte, confiez votre véhicule à votre concessionnaire Lexus pour qu'il règle le faisceau des phares.



امداد خودرو فارما

تلفن شبانه روزی: ۰۲۱-۸۸۸۶۲۰۸۵

FarmaSOS.com

What to do if... (Troubleshooting).....	604
Alphabetical index.....	610

امداد خودرو فارما

تلفن شبانه روزی: ۰۲۱-۸۸۸۶۲۰۸۵

FarmaSOS.com

For information regarding the equipment listed below, refer to "NAVIGATION AND MULTIMEDIA SYSTEM OWNER'S MANUAL".

- Navigation system
- Audio/visual system
- Rear seat entertainment system
- Intuitive parking assist
- Lexus parking assist monitor

What to do if... (Troubleshooting)

If you have a problem, check the following before contacting your Lexus dealer.

The doors cannot be locked, unlocked, opened or closed



You lose your keys

- If you lose your mechanical keys, new genuine mechanical keys can be made by your Lexus dealer. (→P. 110)
- If you lose your electronic keys, the risk of vehicle theft increases significantly. Contact your Lexus dealer immediately. (→P. 112)



The doors cannot be locked or unlocked

- Is the electronic key battery weak or depleted? (→P. 483)
- Is the engine switch in IGNITION ON mode?
When locking the doors, turn the engine switch off. (→P. 209)
- Is the electronic key left inside the vehicle?
When locking the doors, make sure that you have the electronic key on your person.
- The function may not operate properly due to the condition of the radio wave. (→P. 122)

**The rear door cannot be opened**

- Is the child-protector lock set?

The rear door cannot be opened from inside the vehicle when the lock is set. Open the rear door from outside and then unlock the child-protector lock. (→P. 134)

**The trunk lid is closed with the electronic key left inside**

- The function to prevent the electronic key from being left inside the trunk will operate and you can open the trunk as usual. Take the key out from the trunk. (→P. 115)

تلفن شبانه روزی: ۰۲۱-۸۸۸۶۲۰۸۵

FarmaSOS.com

If you think something is wrong**The engine does not start**

- Did you press the engine switch while firmly depressing the brake pedal? (→P. 208)
- Is the shift lever in P? (→P. 208)
- Is the electronic key anywhere detectable inside the vehicle? (→P. 117)
- Is the steering wheel unlocked? (→P. 210)
- Is the electronic key battery weak or depleted?
In this case, the engine can be started in a temporary way.
(→P. 538)
- Is the battery discharged? (→P. 539)

**The shift lever cannot be shifted from P even if you depress the brake pedal**

- Is the engine switch in IGNITION ON mode?
If you cannot release the shift lever by depressing the brake pedal with the engine switch in IGNITION ON mode
(→P. 531)

**The steering wheel cannot be turned after the engine is stopped**

- It is locked automatically to prevent theft of the vehicle.
(→P. 210)



The windows do not open or close by operating the power window switches

- Is the window lock switch pressed?
The power window except for the one at the driver's seat cannot be operated if the window lock switch is pressed. (→P. 181)
-



The engine switch is turned off automatically

- The auto power off function will be operated if the vehicle is left in ACCESSORY mode for a period of time. (→P. 210)
-



A warning buzzer sounds during driving

- The seat belt reminder light is flashing
Are the driver and the front passenger wearing the seat belts?
(→P. 507)
- The parking brake indicator is on
Is the parking brake released? (→P. 225)

Depending on the situation, other types of warning buzzer may also sound. (→P. 504, 514)

**An alarm is activated and the horn sounds**

- Did anyone inside the vehicle open a door during setting the alarm?

The sensor detects it and the alarm sounds. (→P. 80)

Do one of the following to stop the alarms:

- Unlock the doors or open the trunk.
- Turn the engine switch to ACCESSORY or IGNITION ON mode, or start the engine.

**A warning buzzer sounds when leaving the vehicle**

- Is the message displayed on the multi-information display?

Check the message on the multi-information display.

(→P. 514)

**A warning light turns on or a warning message is displayed**

- When a warning light turns on or a warning message is displayed, refer to P. 504, 514.

When a problem has occurred**If you have a flat tire**

- Vehicles with a spare tire
Stop the vehicle in a safe place and replace the flat tire with the spare tire. (→P. 518)
- Vehicles with run-flat tires
Slow down and drive with extra caution. Take your vehicle to the nearest Lexus dealer or authorized tire dealer to have the flat tire replaced. (→P. 527)

**The vehicle becomes stuck**

- Try the procedure for when the vehicle becomes stuck in mud, dirt, or snow. (→P. 547)

FarmaSOS.com

Alphabetical index

A

A/C	
Air conditioning filter.....	480
Front automatic air conditioning system.....	334
Rear air conditioning system.....	352
ABS (Anti-lock Brake System).....	286
Function	286
Warning light	505
Adaptive Front-lighting system (AFS).....	232
AFS (Adaptive Front-lighting System).....	232
Air conditioning filter.....	480
Air conditioning system	
Air conditioning filter.....	480
Front automatic air conditioning system	334
Rear air conditioning system.....	352
Airbags.....	44
Airbag operating conditions	52
Airbag precautions for your child	47
Airbag warning light	505
Correct driving posture.....	36
Curtain shield airbag operating conditions	53
Curtain shield airbag precautions	47
Front passenger occupant classification system.....	57
General airbag precautions	47
Locations of airbags.....	44
Modification and disposal of airbags.....	51
Side airbag operating conditions	53
Side airbag precautions	47
Side and curtain shield airbags operating conditions	53
Side and curtain shield airbags precautions	47
SRS airbags.....	44
Alarm	
Alarm.....	80
Warning buzzer.....	504, 514
Anchor brackets.....	68, 69

Antennas (smart access system with push-button start)..... 116	B
Anti-lock Brake System (ABS)..... 286	Back-up lights
Function 286	Replacing light bulbs 491
Warning light 505	Battery 460
Approach warning..... 261	Battery checking..... 460
Armrest 399	If the vehicle battery
Armrest door 409	is discharged 539
Ashtrays..... 385	Preparing and checking before
Assist grips 412	winter..... 321
Audio/visual system*	Warning light..... 505
Automatic headlight leveling	Blind Spot Monitor (BSM) 306
system 233	Brake
Automatic High Beam 235	Brake Hold 228
Automatic light control	Fluid 459
system 231	Parking brake 225
Automatic transmission 213, 218	Warning light..... 504, 506
If the shift lever	Brake assist 286
cannot be shifted from P 531	Brake Hold 228
M mode 221	Break-in tips 192
Paddle shift switches 214, 220	Brightness control
S mode 215	Instrument panel light control 91
Auxiliary boxes 376	BSM (Blind Spot Monitor) 306

*: Refer to "NAVIGATION AND MULTIMEDIA SYSTEM OWNER'S MANUAL".

C

Card key	108	Child safety	63
Care	428, 432	Airbag precautions	47
Aluminum wheels	429	Battery precautions	461, 542
Exterior	428	Child restraint system	64
Interior	432	Climate control seat	
Seat belts	433	precautions	398
Cargo capacity	205	Heated steering wheel	
Cargo hooks	379	precautions	393
Cargo net	379	How your child should wear	
Chains	323	the seat belt	39, 40
Child restraint system	64	Installing child restraints	68
Booster seats, definition	64	Moon roof precautions	188
Booster seats, installation	73	Power window lock switch	181
Convertible seats, definition	64	Power window precautions	183
Convertible seats, installation	71	Rear door child-protectors	134
Front passenger occupant		Removed electronic	
classification system	57	key battery precautions	484
Infant seats, definition	64	Seat belt comfort guide	39
Infant seats, installation	71	Seat belt extender precautions	43
Installing CRS		Seat belt precautions	67
with LATCH anchors	70	Seat heater precautions	398
Installing CRS with seat belts	71	Trunk precautions	140
Installing CRS			
with top tether strap	74		

Child-protectors.....	134	D	
Cigarette lighter	386	Daytime running light system.....	233
Cleaning.....	428, 432	Defogger	
Aluminum wheels	429	Front windshield.....	342
Exterior.....	428	Outside rear view mirrors	359
Interior	432	Rear window.....	359
Seat belts.....	433	Differential	
Climate control seat.....	394	Front differential	557
Climate control seat filter	397	Rear differential.....	557
Clock.....	384	Dimensions	550
Clock light.....	361	Dinghy towing	207
Coat hooks.....	411	Display	
Coin holder.....	368	Dynamic radar cruise control	
Condenser.....	458	with full-speed range	254
Console box.....	371	LKA (Lane-Keeping Assist).....	275
Cool box	373	Multi-information display.....	94
Coolant.....	457	Remote Touch screen	326
Capacity	555	Trip information.....	95
Checking.....	457	Warning message.....	514
Preparing and checking		Do-it-yourself maintenance.....	443
before winter	321	Door courtesy lights	361
Cooling system	457		
Engine overheating.....	543		
Cruise control			
Cruise control.....	250		
Dynamic radar cruise control			
with full-speed range.....	254		
Cup holders.....	369		
Curtain shield airbags	45		
Customizable features.....	577		

Door lock	
Doors	133
Smart access system with	
push-button start	113
Wireless remote control	129
Door pockets	368
Doors	133
Automatic door locking	
and unlocking system	135
Door glasses	181
Door lock	133
Open door warning buzzer	118
Open door warning light	507
Outside rear view mirrors	177
Rear door child-protector	134
Driver's seat position memory	163
Driving	190
Break-in tips	192
Correct driving posture	36
Driving mode select switch	281
Procedures	190
Winter drive tips	321
Dynamic radar cruise control	
with full-speed range	254
Function	254
E	
Eco drive mode	281
Eco Driving Indicator	96
EDR (Event data recorder)	11
Electric Power Steering (EPS)	287
Function	287
Warning light	505
Electronic key	108
If the electronic key does not	
operate properly	536
Replacing the battery	483
Electronically modulated air	
suspension	284
Emergency flashers	494
Emergency, in case of	
If the electronic key	
does not operate properly	536
If the engine will not start	529
If the parking brake	
cannot be released	532
If the shift lever	
cannot be shifted from P	531
If the vehicle battery is	
discharged	539
If the warning buzzer sounds	504
If the warning light turns on	504
If the warning message	
is displayed	514
If you have a flat tire	518, 527
If you think something	
is wrong	502
If your vehicle becomes	
stuck	547
If your vehicle has to be	
stopped in an emergency	495
If your vehicle needs	
to be towed	496
If your vehicle overheats	543

Engine

ACCESSORY mode.....	209
Compartment.....	449
Engine switch.....	208
Hood.....	446
How to start the engine.....	208
Identification number.....	552
If the engine will not start.....	529
Ignition switch (engine switch).....	208
Overheating.....	543
Engine compartment cover.....	451
Engine coolant.....	457
Capacity.....	555
Checking.....	457
Preparing and checking before winter.....	321
Engine coolant temperature gauge.....	89
Engine immobilizer system.....	78
Engine oil.....	453
Capacity.....	553
Checking.....	453
Preparing and checking before winter.....	321
Engine oil maintenance data.....	455
Engine switch.....	208
EPS	
(Electric Power Steering).....	287
Function.....	287
Warning light.....	505
Event data recorder (EDR).....	11

F

First-aid kit storage belt.....	381
Flat tire	
Vehicles with a spare tire.....	518
Vehicles with run-flat tires.....	527
Floor mats.....	34
Fluid	
Automatic transmission.....	556
Brake.....	558
Washer.....	463
Fog lights.....	240
Replacing light bulbs.....	491
Switch.....	240
Footwell light.....	361
Front fog lights.....	240
Replacing light bulbs.....	491
Switch.....	240
Front automatic air conditioning system.....	334
Front passenger occupant classification system.....	57
Front seats.....	144
Adjustment.....	144
Cleaning.....	432
Climate control seats.....	394
Correct driving posture.....	36
Driving position memory.....	163
Head restraints.....	170
Power easy access system.....	147
Seat position memory.....	163
Front side marker lights.....	231
Light switch.....	231
Replacing light bulbs.....	491
Welcome light illumination control.....	114

Front turn signal lights	224
Replacing light bulbs.....	491
Turn signal lever	224
Fuel.....	246
Capacity	553
Fuel gauge.....	89
Fuel pump shut off system.....	503
Information.....	563
Refueling.....	246
Type.....	553, 563
Warning light	507
Fuel filler door.....	246
If the fuel filler door cannot be opened	249
Refueling.....	246
Fuel pump shut off system.....	503
Fuses.....	485

G

Garage door opener	413
Gauges.....	89
Glove box.....	367

H

Head restraints.....	170
Active head restraint.....	171
Adjustment	170
Headlight cleaner	245
Headlights.....	231
Adaptive Front-lighting System (AFS).....	232
Automatic High Beam system ...	235
Discharge headlights precautions	492
Light switch.....	231
Replacing light bulbs	491
Wattage	562
Headlight aim	489
Heaters	
Front automatic air conditioning system.....	334
Heated steering wheel	392
Outside rear view mirrors	359
Rear air conditioning system	352
Seat heaters.....	395
Height control	
Electronically modulated air suspension.....	284
Hill-start assist control	286
Hood	446
Open	446
Hooks	
Cargo hooks	379
Coat hooks.....	411
Retaining hooks (floor mat).....	34
Shopping bag hooks	379
Horn.....	230

I	J
I/M test 442	Jack
Identification 551	Positioning a floor jack..... 447
Engine..... 552	Vehicle-equipped jack 519, 528
Vehicle..... 551	Jack handle 519, 528
Ignition switch (engine switch)..... 208	Jam protection function
Illuminated entry system..... 364	Moon roof..... 186
Immobilizer system..... 78	Power trunk opener
Indicators 87	and closer 139
Initialization	Power windows..... 182
Engine oil maintenance data..... 455	Rear door sunshade 407
Maintenance..... 436	
Moon roof 187	K
Power windows..... 182	Keyless entry 113
Tire pressure	Smart access system
warning system..... 466	with push-button start..... 113
Initiators (tire pressure	Wireless remote control..... 129
warning system)..... 473	Keys 108
Inside door handle lights 361	Electronic key..... 108
Inside rear view mirror 175	Engine switch 208
Instrument panel light control 91	If the electronic key
Instrument panel ornament	does not operate properly..... 536
lights..... 361	If you lose your keys..... 110, 112
Interior lights..... 362	Key number plate 108
Front interior light 362	Keyless entry..... 113, 129
Rear interior light..... 362	Mechanical key..... 109
Interior lights list..... 361	Replacing the battery 483
Intuitive parking assist*	Warning buzzer..... 118
	Wireless remote control key 129
	Knee airbags 44

*: Refer to "NAVIGATION AND MULTIMEDIA SYSTEM OWNER'S MANUAL".

L

Lane-Keeping Assist (LKA).....	271
Operation.....	272
Language	
(multi-information display).....	99
LATCH anchors.....	70
Lever	
Auxiliary catch lever.....	446
Hood lock release lever.....	446
Internal trunk release lever.....	139
Shift lever.....	213, 218
Turn signal lever.....	224
Wiper lever.....	241
Lexus Climate Concierge.....	333
Lexus Enform Safety Connect.....	420
Lexus night view.....	316
Lexus parking assist monitor*	
License plate lights.....	231
Light switch.....	231
Replacing light bulbs.....	491
Welcome light	
illumination control.....	114
Light bulbs	
Replacing.....	491
Wattage.....	562

Lights

Automatic High Beam system ...	235
Fog light switch.....	240
Headlight switch.....	231
Illuminated entry system.....	364
Interior lights.....	362
Interior lights list.....	361
Personal lights.....	363
Replacing light bulbs.....	491
Trunk light.....	139
Turn signal lever.....	224
Vanity lights.....	382
Wattage.....	562
Welcome light illumination	
control.....	114
LKA (Lane-Keeping Assist).....	271
Operation.....	272
Lock steering column.....	210
Luggage security system.....	138

M

Maintenance	
Do-it-yourself maintenance.....	443
General maintenance	438
Maintenance data.....	550
Maintenance requirements.....	435
Malfunction indicator lamp	505
Master warning light	507
Meter.....	89
Indicators.....	87
Instrument panel light control.....	91
Meters.....	89
Multi-information display	94
Warning lights	85
Micro dust and pollen filter	346
Mirrors	
Inside rear view mirror	175
Outside rear view mirror	
defoggers.....	359
Outside rear view mirrors.....	177
Vanity mirrors.....	382
Moon roof.....	185
Door lock linked	
moon roof operation	186
Jam protection function.....	186
Operation.....	185
Multi-information display	94
Dynamic radar cruise control	
with full-speed range.....	254
Lane-Keeping Assist.....	275
Language	99
Switching the display.....	95
Trip information	95
Warning message.....	514

N

Navigation system*	
Noise from under vehicle	8

O

Odometer.....	89
Oil	
Engine oil.....	553
Front differential oil	557
Rear differential oil	557
Opener	
Fuel filler door.....	248
Hood.....	446
Trunk.....	137
Outer foot lights	
Location	361
Replacing light bulbs	491
Outside rear view mirrors.....	177
Adjusting and folding	177
BSM (Blind Spot Monitor)	306
Linked mirror function	
when reversing.....	179
Mirror position memory	163
Outside rear view	
mirror defoggers.....	359
Outside temperature display	89
Overheating, Engine	543

*: Refer to "NAVIGATION AND MULTIMEDIA SYSTEM OWNER'S MANUAL".

P

Paddle shift switches	214, 220	Power windows.....	181
Parking brake.....	225	Door lock linked	
If the parking brake		window operation	183
cannot be released.....	532	Jam protection function.....	182
Operation	225	Operation.....	181
Parking brake engaged		Window lock switch	181
warning buzzer	227	Pre-Collision System (PCS).....	293
Parking lights.....	231	Function.....	293
Light switch.....	231	Pre-collision braking off	
Replacing light bulbs.....	491	switch	295
Welcome light		Warning light.....	506
illumination control	114		
PCS (Pre-Collision System).....	293		
Function	293		
Pre-collision braking off			
switch.....	295		
Warning light.....	506		
Pelvic support seat with seat			
vibrator	155		
Personal lights.....	363		
Front personal light	363		
Rear personal light	363		
Power easy access system	147		
Power outlets	388		
Power steering (Electric Power			
Steering system).....	287		
Warning light	505		
Power trunk opener and closer	137		

R

Radar cruise control (dynamic radar cruise control).....	254	Rear sunshade.....	402
Radiator.....	458	Operation.....	402
Rear air conditioning system.....	352	Reverse operation feature.....	404
Rear Cross Traffic Alert.....	313	Rear turn signal lights.....	224
Rear door sunshades.....	406	Replacing light bulbs.....	491
Rear seat		Turn signal lever.....	224
Adjustment.....	150	Rear view mirror	
Climate control seats.....	394	Inside rear view mirror.....	175
Seat heaters.....	395	Outside rear view mirrors.....	177
Seat position memory.....	168	Rear window defoggers.....	359
Rear seat entertainment system*		Refueling.....	246
Rear seat position memory.....	168	Capacity.....	553
Rear seat relaxation system.....	157	Fuel types.....	553
Rear side marker lights.....	231	If the fuel filler door cannot be opened.....	249
Light switch.....	231	Opening the fuel tank cap.....	248
Replacing light bulbs.....	491	Remote Touch.....	326
Welcome light illumination control.....	114	Remote Touch screen.....	326
		Replacing	
		Electronic key battery.....	483
		Fuses.....	485
		Light bulbs.....	491
		Tires.....	518
		Reporting safety defects for U.S. owners.....	588
		Resetting the message indicating maintenance is required.....	436
		Retractable table.....	400
		Run-flat tires.....	527

*: Refer to "NAVIGATION AND MULTIMEDIA SYSTEM OWNER'S MANUAL".

S

- Seat belt reminder light..... 507
- Seat belts..... 38
- Adjusting the seat belt.....39
 - Automatic locking retractor (ALR).....40
 - Child restraint system installation.....71
 - Cleaning and maintaining the seat belt.....433
 - Emergency locking retractor (ELR).....40
 - How to wear your seat belt.....38
 - How your child should wear the seat belt.....40
 - Pre-collision seat belts.....40
 - Pregnant women, proper seat belt use.....41
 - Reminder light and buzzer..... 507
 - Seat belt extender.....40
 - Seat belt pretensioners.....39
 - SRS warning light.....505
- Seat cushion airbag..... 45
- Seat heaters..... 395
- Seat position memory..... 163, 168
- Seating capacity.....205
- Seats.....144, 150
- Adjustment.....144, 150
 - Adjustment precautions.....149, 161
 - Child seats/child restraint system installation.....68
 - Cleaning.....432
 - Climate control seat.....394
 - Driving position memory.....163
 - Head restraints.....170
 - Pelvic support seat with seat vibrator.....155
 - Power easy access system.....147
 - Properly sitting in the seat.....36
 - Rear seat position memory.....168
 - Rear seat relaxation system.....157
 - Seat heaters.....395
 - Seat position memory.....163, 168
- Sensor
- Automatic headlight system.....233
 - Automatic High Beam system.....239
 - Camera sensors.....296
 - Driver monitor sensor.....296
 - Inside rear view mirror.....176
 - Lexus night view.....320
 - LKA (Lane-Keeping Assist).....271
 - Radar sensor.....265, 295, 309
 - Rain-sensing windshield wipers.....243
- Service reminder indicators.....84
- Shift lever.....213, 218
- Automatic transmission.....213, 218
 - If the shift lever cannot be shifted from P.....531
- Shift lever light.....361
- Shift lock system.....531
- Shopping bag hooks.....379

Side airbags	45	Spark plug	555
Side marker lights.....	231	Specifications.....	550
Light switch	231	Speedometer	89
Replacing light bulbs.....	491	Sport mode.....	281
Welcome light illumination control.....	114	Steering lock	210
Column lock release	210	Steering wheel	174
Side mirrors	177	Adjustment.....	174
Adjusting and folding.....	177	Heated steering wheel	392
BSM (Blind Spot Monitor).....	306	Power easy access system.....	147
Linked mirror function when reversing.....	179	Steering wheel position memory	163
Mirror position memory.....	163	Stop lights	
Side turn signal lights	224	Replacing light bulbs	491
Replacing light bulbs.....	491	Storage feature.....	365
Turn signal lever	224	Stuck	
Smart access system		If the vehicle becomes stuck.....	547
with push-button start	113	Sun shade	
Antenna location.....	116	Rear	402
Entry functions.....	113	Rear door.....	406
Starting the engine	208	Roof	186
Snow mode	216, 222	Sun visors.....	382
Snow tires	324		
Spare tire.....	518		
Inflation pressure.....	559		
Storage location	519		

Switches

Automatic High Beam		Moon roof switches	185
switch.....	235	Outside rear view mirror	
Brake hold switch	228	switches	177
BSM (Blind spot monitor)		Paddle shift switches.....	214, 220
main switch.....	306	Parking brake switch	225
Climate control seat switches.....	394	Power door lock switch.....	133
Cruise control switch.....	250	Power trunk lid.....	137
"DISP" button	95	Power window switches	181
Door lock switches	133	Pre-collision braking off	
Driving mode select switch	281	switch	295
Driving position memory		Rear door sunshade switch.....	406
switches.....	163	Rear seat position memory	
Dynamic radar cruise control		switches	168
with full-speed range.....	254	Rear sunshade switch	402
Emergency flashers switch	494	Rear window and outside	
Engine switch.....	208	rear view mirror defoggers	
Fog light switch	240	switch	359
Garage door opener		Seat heater switches	395
switches.....	413	Snow mode switch.....	216, 222
Headlight cleaner switch	245	"SOS" button	420
Heated steering wheel		Tilt and telescopic	
switch.....	392	steering control switch.....	174
Ignition switch	208	Tire pressure warning reset	
Lexus night view switch.....	316	switch	467
Light switch	231	Trunk closer switch.....	138
LKA (Lane-Keeping Assist)		Trunk opener main switch	138
switch.....	273	Trunk opener switch	137
		Vehicle-to-vehicle distance	
		button.....	257
		VSC OFF switch.....	288
		Window lock switch	181
		Windshield wipers	
		and washer switch.....	241

T

Tachometer	89	Tires	464
Tail lights.....	231	Chains	323
Light switch	231	Checking	464
Replacing light bulbs.....	491	If you have a flat tire.....	518, 527
Welcome light illumination		Inflation pressure.....	559
control.....	114	Information.....	566
Theft deterrent system		Replacing.....	518
Alarm.....	80	Rotating tires.....	465
Engine immobilizer system.....	78	Run-flat tires	527
Tire inflation pressure.....	475	Size	559
Maintenance data.....	559	Snow tires.....	324
Tire inflation pressure display		Spare tire.....	518
function.....	97	Tire inflation pressure display	
Warning light	508	function.....	97
Tire information.....	566	Tire pressure warning system.....	466
Glossary.....	572	Warning light.....	508
Size.....	568	Tools	519, 528
Tire identification number.....	567	Top tether strap	74
Uniform Tire Quality		Total load capacity.....	205
Grading.....	570	Towing	
Tire pressure warning system	466	Dinghy towing.....	207
Function.....	466	Emergency towing	496
Initializing.....	466	Towing eyelet	499
Installing tire pressure warning		Trailer towing.....	206
valves and transmitters.....	466	TRAC (Traction Control).....	286
Registering ID codes	468	Trailer towing.....	206
Tire pressure warning reset		Transmission	213, 218
switch.....	467	Automatic transmission.....	213, 218
Warning light	508	Driving mode select switch.....	281
		If the shift lever cannot be	
		shifted from P	531
		M mode.....	221
		Paddle shift switches.....	214, 220
		S mode.....	215
		Trip information	95
		Trip meters.....	89

W

Warning buzzers	
Approach warning.....	261
Brake system.....	504
Downshifting.....	216, 222
Key reminder.....	118
No-handed driving warning.....	276
Open door.....	507
Open moon roof.....	188
Seat belt reminder.....	507
Warning lights	85
ABS.....	505
Brake hold operated indicator.....	228
Brake system.....	504, 506
Charging system.....	505
Electric power steering.....	505
Low fuel level.....	507
Malfunction indicator lamp.....	505
Master warning light.....	507
Open door.....	507
Parking brake indicator.....	506
Pre-collision system.....	506
Seat belt reminder light.....	507
Slip indicator.....	506
SRS.....	505
Tire pressure.....	508
Washer	241
Checking.....	463
Preparing and checking before winter.....	321
Switch.....	241
Washing and waxing	428
Weight	
Cargo capacity.....	205
Load limits.....	205
Weight.....	550
Welcome light illumination control	114
Wheels	478
Replacing wheels.....	478
Size.....	559
Window glasses	181
Window lock switch	181
Windows	181
Power windows.....	181
Rear window defogger.....	359
Windshield wiper de-icer	360
Windshield wipers	241
Winter driving tips	321
Wireless remote control key	129
Locking/Unlocking.....	129
Replacing the battery.....	483

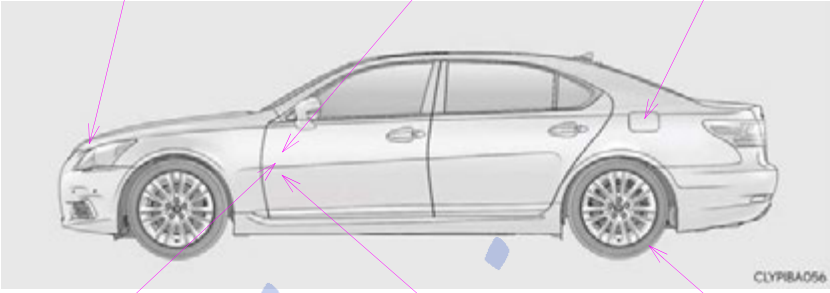
GAS STATION INFORMATION		
Auxiliary catch lever P. 446	Trunk opener P. 137	Fuel filler door P. 248
		
Hood lock release lever P. 446	Fuel filler door opener P. 248	Tire inflation pressure P. 559
Fuel tank capacity (Reference)	22.2 gal. (84 L, 18.4 Imp. gal.)	
Fuel type	Premium unleaded gasoline only	P. 553, 563
Cold tire inflation pressure	P. 559	
Engine oil capacity (Drain and refill – reference)	With filter 2WD models AWD models Without filter	qt. (L, Imp. qt.) 9.1 (8.6, 7.6) 9.5 (9.0, 7.9) 8.9 (8.4, 7.4)
Engine oil type	"Toyota Genuine Motor Oil" or equivalent Oil grade: ILSAC GF-5 multigrade engine oil Recommended viscosity: SAE 0W-20 P. 553	