



ایران خودرو فارما  LEXUS

تلفن شبانه روزی: ۰۲۱-۸۸۸۶۲۰۸۵

[FarmaSOS.com](http://FarmaSOS.com)

2013

GS 350

OWNER'S MANUAL



## Your Lexus dealer

Your Lexus dealer will provide quality maintenance and any other assistance you may require.

If there is not a Lexus dealer near you, please call the following number:

### ■ U.S. OWNERS

- In the U.S. mainland or Canada:

Lexus Roadside Assistance

1-800-25-LEXUS or 1-800-255-3987 (Toll-Free)

- In Hawaii:

Servco Automotive Roadside Assistance/Customer Services

1-800-25-LEXUS or 1-800-255-3987 (Toll-Free)

### ■ CANADIAN OWNERS

- In Canada or the U.S. mainland:

Lexus Roadside Assistance/Customer Service

1-800-26-LEXUS or 1-800-265-3987 (Toll-Free)

Please access our **websites** for further information.

- The U.S. mainland: [www.lexus.com](http://www.lexus.com)
- Hawaii: [www.servcolexus.com](http://www.servcolexus.com)
- Canada: [www.lexus.ca](http://www.lexus.ca)

©2011 TOYOTA MOTOR CORPORATION

All rights reserved. This material may not be reproduced or copied, in whole or in part, without the written permission of Toyota Motor Corporation.

## Pictorial index

Search by illustration

### 1 For safety and security

Make sure to read though them

### 2 Instrument cluster

How to read the gauges and meters, the variety of warning lights and indicators, etc.

### 3 Operation of each component

Opening and closing the doors and windows, adjustment before driving, etc.

### 4 Driving

Operations and advices which are necessary for driving

### 5 Interior features

Usage of the interior features, etc.

### 6 Maintenance and care

Caring for your vehicle and maintenance procedures

### 7 When trouble arises

What to do in case of malfunction or emergency

### 8 Vehicle specifications

Vehicle specification, customizable features, etc.

### For owners

### Index

Search by symptom

Search alphabetically

For your information .....	8
Reading this manual.....	12
How to search .....	13
Pictorial index.....	14

## 1 For safety and security

### 1-1. For safe use

Before driving.....	26
For safety drive.....	28
Seat belts.....	30
SRS airbags.....	36
Front passenger occupant classification system.....	47
Safety information for children .....	52
Child restraint systems .....	53
Installing child restraints.....	57
Exhaust gas precautions.....	67

### 1-2. Theft deterrent system

Engine immobilizer system.....	68
Alarm .....	70

## 2 Instrument cluster

### 2. Instrument cluster

Warning lights and indicators.....	74
Gauges and meters.....	79
Multi-information display .....	82
Head-up display.....	90

## 3 Operation of each component

### 3-1. Key information

Keys .....	98
------------	----

### 3-2. Opening, closing and locking the doors and trunk

Smart access system with push-button start .....	101
Wireless remote control .....	114
Doors .....	117
Trunk.....	121

### 3-3. Adjusting the seats

Front seats.....	128
Driving position memory.....	130
Head restraints .....	136

### 3-4. Adjusting the steering wheel and mirrors

Steering wheel.....	139
Inside rear view mirror .....	140
Outside rear view mirrors.....	142

### 3-5. Opening, closing the windows and moon roof

Power windows.....	145
Moon roof.....	148



## 4 Driving

### 4-1. Before driving

Driving the vehicle .....	154
Cargo and luggage.....	165
Vehicle load limits .....	168
Trailer towing .....	169
Dinghy towing .....	170

### 4-2. Driving procedures

Engine (ignition) switch.....	171
Automatic transmission .....	178
Turn signal lever .....	184
Parking brake .....	186
Horn .....	189

### 4-3. Operating the lights and wipers

Headlight switch .....	190
Fog light switch .....	195
Windshield wipers and washer .....	196
Headlight cleaner switch.....	203

### 4-4. Refueling

Opening the fuel tank cap .....	204
---------------------------------	-----

### 4-5. Using the driving support systems

Cruise control .....	209
Dynamic radar cruise control.....	213
LKA (Lane-Keeping Assist).....	228
Intuitive parking assist.....	238
Rear view monitor system.....	251
Drive mode select switch .....	263
Driving assist systems .....	268
Hill-start assist control .....	276
PCS (Pre-Collision System) .....	278
BSM (Blind Spot Monitor) .....	287
Lexus night view .....	293

### 4-6. Driving tips

Winter driving tips .....	298
---------------------------	-----

1

2

3

4

5

6

7

8

## 5 Interior features

### 5-1. Remote Touch screen

Remote Touch .....	306
Remote Touch screen .....	308
Set up screen .....	317
Voice command system .....	334

### 5-2. Using the air conditioning system and defogger

Front automatic air conditioning system .....	345
Rear air conditioning system .....	360
Rear window and outside rear view mirror defoggers .....	365
Windshield wiper de-icer .....	366

### 5-3. Using the audio system

Audio system type .....	367
Using the radio .....	390
Using the CD/DVD player .....	412
Playing an audio CD and MP3/WMA discs .....	414
Playing DVD video .....	420
CD/DVD player and DVD video disc information .....	432
Listening to Bluetooth® audio .....	444
Listening to a USB memory .....	454
Listening to an iPod .....	464
Optimal use of the audio/video system .....	474
Using the AUX port .....	476
Using the rear seat audio controls .....	477
Using the steering wheel audio switches .....	482

### 5-4. Using the hands-free phone system (for cellular phone)

Hands-free system (for cellular phone) .....	485
Using a Bluetooth® phone .....	493
Setting the hands-free system (for cellular phone) .....	512
Setting the Bluetooth® .....	535

### 5-5. Using the interior lights

Interior lights list .....	548
• Interior light .....	549
• Personal lights .....	549

## 5-6. Using the storage features

List of storage features .....	551
• Glove box .....	553
• Console box .....	554
• Cup holders .....	555
• Auxiliary boxes .....	557
Trunk features .....	558

## 5-7. Other interior features

Sun visors and vanity mirrors .....	561
Clock .....	562
Ashtrays .....	563
Power outlets .....	564
Heated steering wheel .....	566
Seat heaters/ seat ventilators .....	568
Armrest .....	571
Rear sunshade/ rear door sunshades .....	572
Trunk storage extension .....	575
Coat hooks .....	576
Assist grip .....	577
Utility hook .....	578
Garage door opener .....	579
Safety Connect .....	586

## 6 Maintenance and care

### 6-1. Maintenance and care

Cleaning and protecting the vehicle exterior .....	594
Cleaning and protecting the vehicle interior .....	598

### 6-2. Maintenance

Maintenance requirements .....	601
General maintenance .....	604
Emission inspection and maintenance (I/M) programs .....	608

### 6-3. Do-it-yourself maintenance

Do-it-yourself service precautions .....	609
Hood .....	612
Positioning a floor jack .....	613
Engine compartment .....	615
Tires .....	629
Tire inflation pressure .....	639
Wheels .....	642
Air conditioning filter .....	644
Electronic key battery .....	646
Checking and replacing fuses .....	648
Headlight aim .....	661
Light bulbs .....	663

## 7 When trouble arises

### 7-1. Essential information

Emergency flashers .....	676
If your vehicle has to be stopped in an emergency.....	677

### 7-2. Steps to take in an emergency

If your vehicle needs to be towed.....	678
If you think something is wrong .....	684
Fuel pump shut off system.....	685
If a warning light turns on or a warning buzzer sounds.....	686
If a warning message is displayed .....	697
If you have a flat tire .....	722
If the engine will not start.....	735
If the shift lever cannot be shifted from P .....	737
If the parking brake cannot be released .....	738
If the electronic key does not operate properly.....	740
If the vehicle battery is discharged.....	743
If your vehicle overheats .....	747
If the vehicle becomes stuck .....	749

ایران خودرو فارما

تلفن سیمانه روزی: ۰۲۱-۸۸۶۲۰۸۵

FarmaSOS.com

## 8 Vehicle specifications

### 8-1. Specifications

Maintenance data (fuel, oil level, etc.) .....	752
Fuel information.....	762
Tire information.....	765

### 8-2. Customization

Customizable features .....	777
-----------------------------	-----

### 8-3. Items to initialize

Items to initialize.....	788
--------------------------	-----

## For owners

Reporting safety defects for U.S. owners.....	790
--	-----

Seat belt instructions for Canadian owners (in French).....	791
---	-----

SRS airbag instructions for Canadian owners (in French).....	793
--	-----

## Index

What to do if... (Troubleshooting) .....	804
Alphabetical index .....	810

1

2

3

4

5

6

7

8

For vehicles with a navigation system, refer to the “Navigation System Owner’s Manual” for information regarding the navigation system.

## For your information

### Main Owner's Manual

Please note that this manual applies to all models and explains all equipment, including options. Therefore, you may find some explanations for equipment not installed on your vehicle.

All specifications provided in this manual are current at the time of printing. However, because of the Lexus policy of continual product improvement, we reserve the right to make changes at any time without notice.

Depending on specifications, the vehicle shown in the illustrations may differ from your vehicle in terms of color and equipment.

### Noise from under vehicle after turning off the engine

Approximately five hours after the engine is turned off, you may hear sound coming from under the vehicle for several minutes. This is the sound of a fuel evaporation leakage check and, it does not indicate a malfunction.

### Accessories, spare parts and modification of your Lexus

A wide variety of non-genuine spare parts and accessories for Lexus vehicles are currently available in the market. You should know that Toyota does not warrant these products and is not responsible for their performance, repair, or replacement, or for any damage they may cause to, or adverse effect they may have on, your Lexus vehicle.

This vehicle should not be modified with non-genuine Lexus products. Modification with non-genuine Lexus products could affect its performance, safety or durability, and may even violate governmental regulations. In addition, damage or performance problems resulting from the modification may not be covered under warranty.

## Installation of a mobile two-way radio system

The installation of a mobile two-way radio system in your vehicle could affect electronic systems such as:

- Multiport fuel injection system/sequential multiport fuel injection system
- Dynamic radar cruise control system
- Cruise control system
- Anti-lock brake system
- Vehicle dynamics integrated management
- SRS airbag system
- Seat belt pretensioner system

Be sure to check with your Lexus dealer for precautionary measures or special instructions regarding installation of a mobile two-way radio system.

## Vehicle control and operation data recording

Your Lexus is equipped with sophisticated computers that record certain information about your vehicle's operation, such as:

- Engine speed
- Accelerator status
- Brake status
- Vehicle speed
- Shift position

The data recorded varies according to the grade level and options the vehicle is equipped with. The computers do not record conversations, sound or pictures.

### ● Data usage

Lexus may use the data recorded in these computers to diagnose malfunctions, conduct research and development, and improve quality.

Lexus will not disclose the recorded data to a third party except:

- With the consent of the vehicle owner or with the consent of the lessee if the vehicle is leased
- In response to an official request by the police, a court of law or a government agency
- For research purposes where the data is not tied to a specific vehicle or vehicle owner

### ● Usage of data collected through Safety Connect / Lexus Enform (U.S. mainland only)

If your Lexus has Safety Connect or Lexus Enform and if you have subscribed to those services, please refer to the Safety Connect / Lexus Enform Telematics Subscription Service Agreement for information on data collected and its usage.

## Event data recorder

This vehicle is equipped with an event data recorder (EDR). The main purpose of an EDR is to record, in certain crash or near crash-like situations, such as an air bag deployment or hitting a road obstacle, data that will assist in understanding how a vehicle's systems performed. The EDR is designed to record data related to vehicle dynamics and safety systems for a short period of time, typically 30 seconds or less.

The EDR in this vehicle is designed to record such data as:

- How various systems in your vehicle were operating;
- Whether or not the driver and passenger safety belts were buckled/fastened;
- How far (if at all) the driver was depressing the accelerator and/or brake pedal; and,
- How fast the vehicle was traveling.

These data can help provide a better understanding of the circumstances in which crashes and injuries occur.

NOTE: EDR data are recorded by your vehicle only if a non-trivial crash situation occurs; no data are recorded by the EDR under normal driving conditions and no personal data (e.g., name, gender, age, and crash location) are recorded. However, other parties, such as law enforcement, could combine the EDR data with the type of personally identifying data routinely acquired during a crash investigation.

To read data recorded by an EDR, special equipment is required, and access to the vehicle or the EDR is needed. In addition to the vehicle manufacturer, other parties, such as law enforcement, that have the special equipment, can read the information if they have access to the vehicle or the EDR.

### ● Disclosure of the EDR data

Lexus will not disclose the data recorded in an EDR to a third party except when:

- An agreement from the vehicle's owner (or the lessee for a leased vehicle) is obtained
- In response to an official request by the police, a court of law or a government agency
- For use by Lexus in a law suit

However, if necessary, Lexus may:

- Use the data for research on vehicle safety performance
- Disclose the data to a third party for research purposes without disclosing information about the specific vehicle or vehicle owner



## Scrapping of your Lexus

The SRS airbag and seat belt pretensioner devices in your Lexus contain explosive chemicals. If the vehicle is scrapped with the airbags and seat belt pretensioners left as they are, this may cause an accident such as fire. Be sure to have the systems of the SRS airbag and seat belt pretensioner removed and disposed of by a qualified service shop or by your Lexus dealer before you scrap your vehicle.

## Perchlorate Material

Special handling may apply, See [www.dtsc.ca.gov/hazardouswaste/perchlorate](http://www.dtsc.ca.gov/hazardouswaste/perchlorate).

Your vehicle has components that may contain perchlorate. These components may include airbag, seat belt pretensioners, and wireless remote control batteries.

### CAUTION

#### ■ General precautions while driving

**Driving under the influence:** Never drive your vehicle when under the influence of alcohol or drugs that have impaired your ability to operate your vehicle. Alcohol and certain drugs delay reaction time, impair judgment and reduce coordination, which could lead to an accident that could result in death or serious injury.

**Defensive driving:** Always drive defensively. Anticipate mistakes that other drivers or pedestrians might make and be ready to avoid accidents.

**Driver distraction:** Always give your full attention to driving. Anything that distracts the driver, such as adjusting controls, talking on a cellular phone or reading can result in a collision with resulting death or serious injury to you, your occupants or others.

#### ■ General precaution regarding children's safety

Never leave children unattended in the vehicle, and never allow children to have or use the key.

Children may be able to start the vehicle or shift the vehicle into neutral. There is also a danger that children may injure themselves by playing with the windows, the moon roof, or other features of the vehicle. In addition, heat build-up or extremely cold temperatures inside the vehicle can be fatal to children.

## Reading this manual



### CAUTION:

Explains something that, if not obeyed, could cause death or serious injury to people.



### NOTICE:

Explains something that, if not obeyed, could cause damage to or a malfunction in the vehicle or its equipment.



... Indicates operating or working procedures. Follow the steps in numerical order.



Indicates the action (pushing, turning, etc.) used to operate switches and other devices.



Indicates the outcome of an operation (e.g. a lid opens).



Indicates the component or position being explained.



Means “Do not”, “Do not do this”, or “Do not let this happen”.



## How to search

### ■ Searching by name

- Alphabetical index ..... P. 810

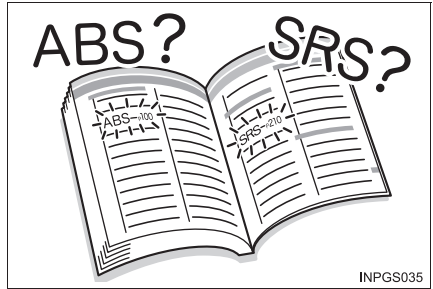

### ■ Searching by installation position

- Pictorial index..... P.14



### ■ Searching by symptom or sound

- What to do if...  
(Troubleshooting)..... P. 804

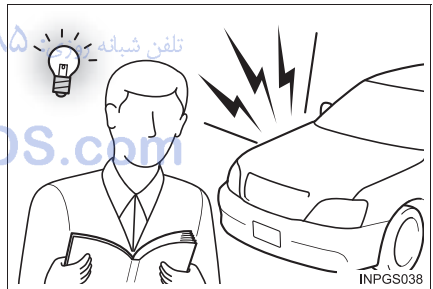

### ■ Searching by title

- Table of contents ..... P. 2

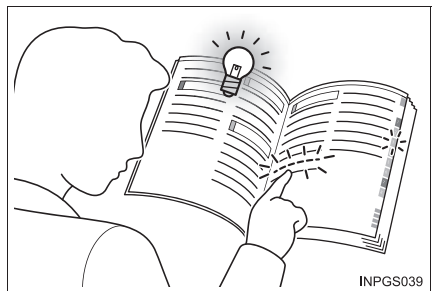

# Pictorial index

## Exterior

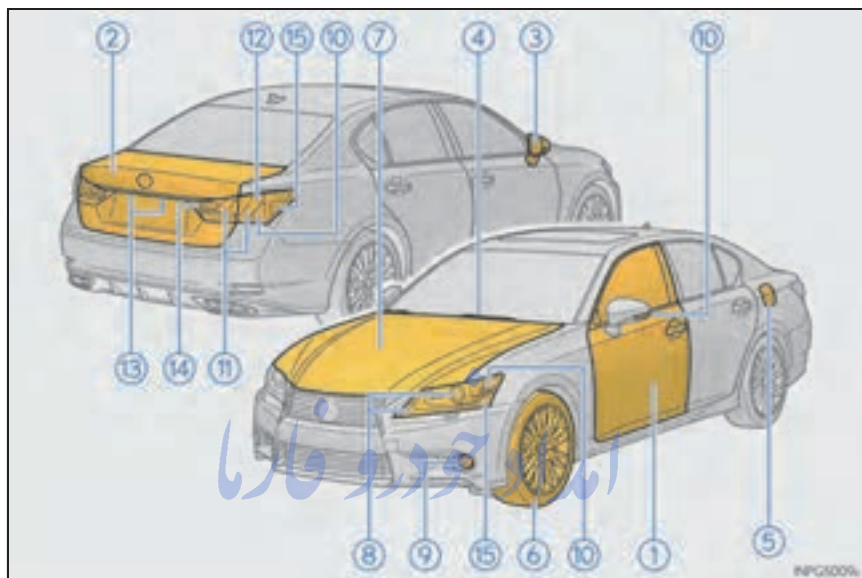

- ① **Doors** ..... P.117  
 Locking/unlocking..... P.102, 114  
 Opening/closing the door glasses .....P.145  
 Locking/unlocking by using the mechanical key ..... P.740  
 Warning lights/warning messages ..... P.689, 704
- ② **Trunk** ..... P.121  
 Opening from inside..... P.121  
 Opening from outside ..... P.102, 114  
 Opening by using the mechanical key ..... P.741  
 Warning lights/warning messages ..... P.689, 705
- ③ **Outside rear view mirrors** ..... P.142  
 Adjusting the mirror angle.....P.142  
 Folding the mirrors .....P.142  
 Driving position memory ..... P.130  
 Defogging the mirrors.....P.365

④	<b>Windshield wipers</b> .....	P. 196
	Precautions against winter season .....	P. 298
	To prevent freezing (windshield wiper de-icer)* .....	P. 366
	Precautions against car wash .....	P. 596
⑤	<b>Fuel filler door</b> .....	P. 204
	Refueling method .....	P. 204
	Fuel type/fuel tank capacity .....	P. 754
⑥	<b>Tires</b> .....	P. 629
	Tire size/inflation pressure .....	P. 759
	Winter tires/tire chain .....	P. 298
	Checking/rotation/tire pressure warning system .....	P. 629
	Coping with flat tires .....	P. 722
⑦	<b>Hood</b> .....	P. 612
	Opening .....	P. 612
	Engine compartment cover .....	P. 616
	Engine oil .....	P. 754
	Coping with overheat .....	P. 747
	Warning messages .....	P. 704

### Light bulbs of the exterior lights for driving

(Replacing method: P. 663, Watts: P. 761)

⑧	<b>Headlights/parking lights/daytime running lights</b> .....	P. 190
⑨	<b>Fog lights*</b> .....	P. 195
⑩	<b>Turn signal lights</b> .....	P. 184
⑪	<b>Tail lights</b> .....	P. 190
⑫	<b>Stop lights</b>	
	Hill-start assist control .....	P. 276
⑬	<b>License plate lights</b> .....	P. 190
⑭	<b>Back-up lights</b>	
	Shifting the shift lever to R .....	P. 178
⑮	<b>Side marker lights</b> .....	P. 190

\*: If equipped

## Instrument panel

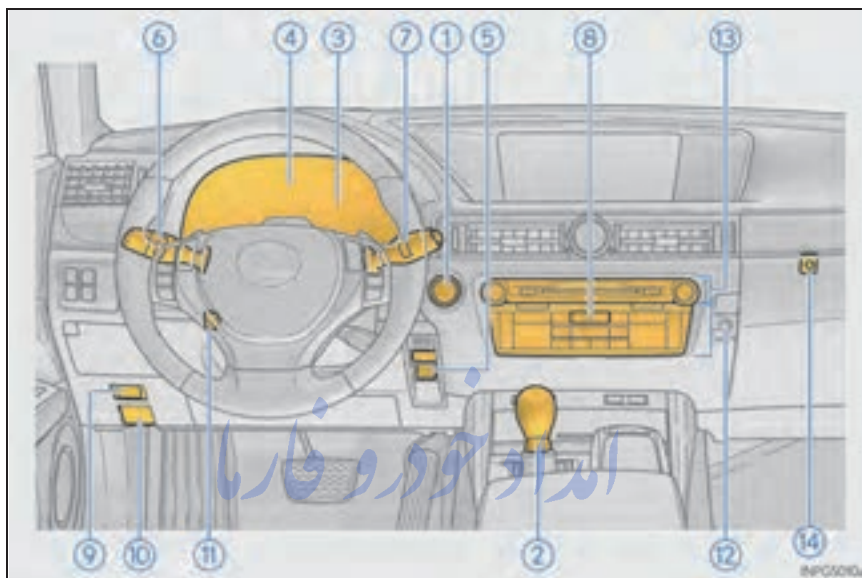

- ① **Engine switch** ..... P.171  
 Starting the engine/changing the modes ..... P.171  
 Emergency stop of the engine ..... P.677  
 When the engine will not start ..... P.735  
 Warning messages ..... P.715
- ② **Shift lever** ..... P.178  
 Changing the shift position ..... P.178  
 Precautions against towing ..... P.678  
 When the shift lever does not move ..... P.737
- ③ **Meters** ..... P.79  
 Reading the meters/adjusting the instrument panel light ..... P.79  
 Warning lights/indicator lights ..... P.74  
 When the warning lights come on ..... P.686

④	<b>Multi-information display</b> .....	<b>P. 82</b>
	Display .....	P. 82
	When the warning messages are displayed .....	P. 697
⑤	<b>Parking brake</b> .....	<b>P. 186</b>
	Applying/releasing .....	P. 186
	Precautions against winter season .....	P. 299
	Warning buzzer/message .....	P. 697
⑥	<b>Turn signal lever</b> .....	<b>P. 184</b>
	<b>Headlight switch</b> .....	<b>P. 190</b>
	Headlights/parking lights/tail lights/daytime running lights .....	P. 190
	Fog lights* .....	P. 195
⑦	<b>Windshield wiper and washer switch</b> .....	<b>P. 196</b>
	Usage .....	P. 196
	Adding washer fluid .....	P. 628
	Warning messages .....	P. 712
⑧	<b>Emergency flasher switch</b> .....	<b>P. 676</b>
⑨	<b>Trunk opener</b> .....	<b>P. 121</b>
⑩	<b>Hood lock release lever</b> .....	<b>P. 612</b>
⑪	<b>Tilt and telescopic steering control switch</b> .....	<b>P. 139</b>
	Adjustment .....	P. 139
	Driving position memory .....	P. 130
⑫	<b>Air conditioning system</b> .....	<b>P. 345</b>
	Usage .....	P. 345
	Rear window defogger .....	P. 365
⑬	<b>Audio system</b> .....	<b>P. 367</b>
	Audio system .....	P. 367
	Hands-free system .....	P. 485
⑭	<b>Trunk opener main switch</b> .....	<b>P. 122</b>

## Switches



- ① Headlight cleaner switch\* ..... P.203
- ② VSC OFF switch..... P.270
- ③ Instrument panel light control switches..... P.80
- ④ Odometer/trip meter and trip meter reset button ..... P.80
- ⑤ HUD (Head-up display) switches\* ..... P.90
- ⑥ Heated steering wheel switch\* ..... P.566
- ⑦ BSM (Blind Spot Monitor) main switch\* ..... P.287
- ⑧ Lexus night view switch\* ..... P.293



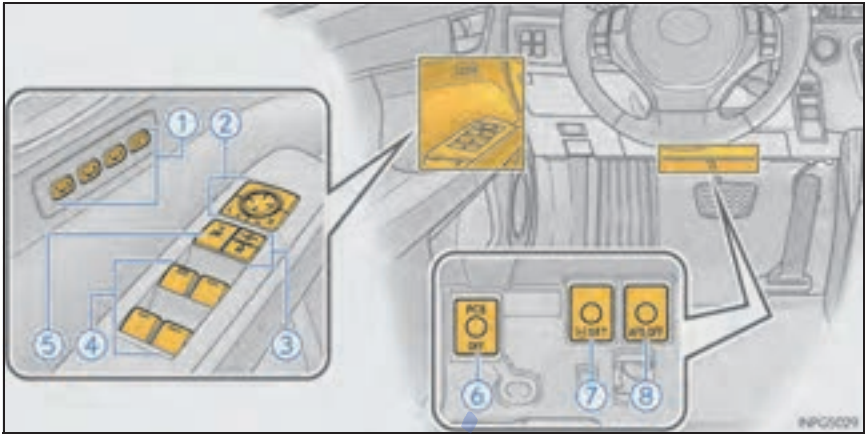

- ① Driving position memory switches ..... P.130
- ② Outside rear view mirror switches ..... P.142
- ③ Door lock switches ..... P.117
- ④ Power window switches ..... P.145
- ⑤ Window lock switch ..... P.145
- ⑥ PCS OFF switch\* ..... P.280
- ⑦ Tire pressure warning reset switch ..... P.632
- ⑧ AFS OFF switch\* ..... P.192

\*: If equipped

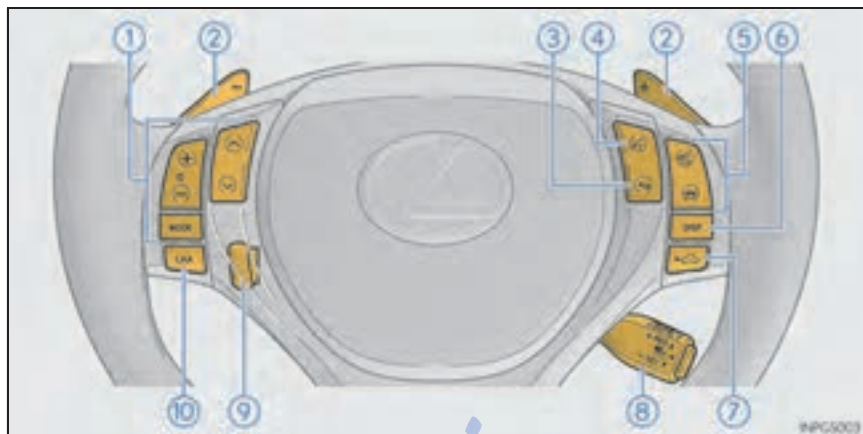

① Audio remote control switches .....	P. 482
② Paddle shift switches.....	P. 180
③ Back switch *1.....	P. 334
④ Talk switch *1 .....	P. 334
⑤ Telephone switches.....	P. 486
⑥ "DISP" button.....	P. 83
⑦ Vehicle-to-vehicle distance button *2.....	P. 216
⑧ Cruise control switch *2.....	P. 209
Dynamic radar cruise control switch *2.....	P. 213
⑨ Tilt and telescopic steering control switch.....	P. 139
⑩ LKA (Lane-Keeping Assist) switch *2.....	P. 230

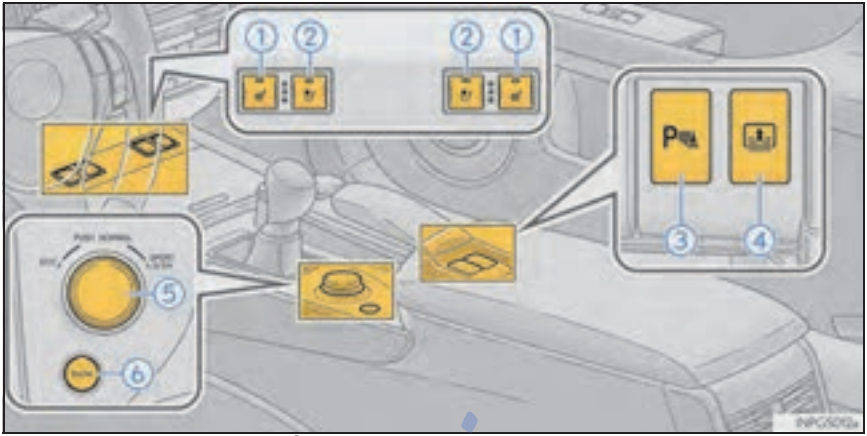

- ① Seat heater switches \*2 ..... P. 568  
 ② Seat ventilator switches \*2 ..... P. 569  
 ③ Intuitive parking assist switch \*2 ..... P. 238  
 ④ Rear sunshade switch \*2 ..... P. 572  
 ⑤ Driving mode select switch ..... P. 263  
 ⑥ Snow mode switch ..... P. 179

FarmaSOS.com

\*1: Refer to "Navigation System Owner's Manual".

\*2: If equipped

## Interior

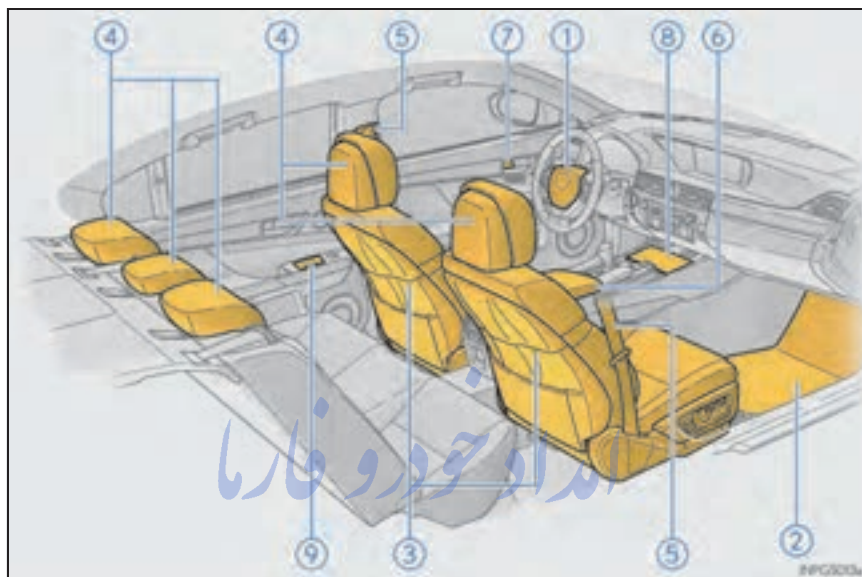

- ① SRS airbags ..... P.36
- ② Floor mats ..... P.26
- ③ Front seats ..... P.128
- ④ Head restraints ..... P.136
- ⑤ Seat belts ..... P.30
- ⑥ Console box ..... P.554
- ⑦ Inside lock buttons ..... P.117
- ⑧ Cup holders ..... P.555
- ⑨ Auxiliary boxes\*<sup>1</sup> ..... P.557
- Ashtrays\*<sup>1</sup> ..... P.563

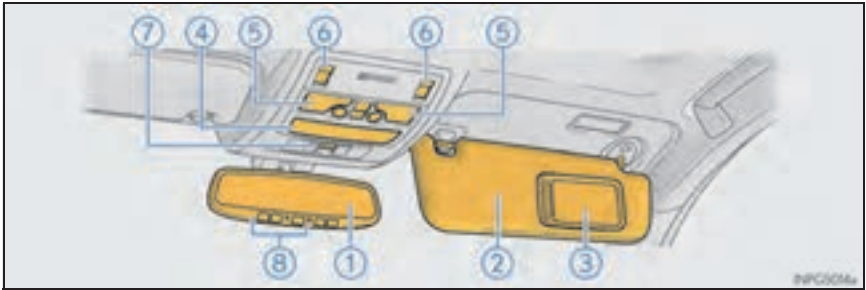

- |                                     |       |
|-------------------------------------|-------|
| ① Inside rear view mirror .....     | P.140 |
| ② Sun visors .....                  | P.561 |
| ③ Vanity mirrors.....               | P.561 |
| ④ Interior light .....              | P.549 |
| ⑤ Personal lights *2 .....          | P.549 |
| ⑥ Moon roof switches .....          | P.148 |
| ⑦ "SOS" button *1 .....             | P.586 |
| ⑧ Garage door opener switches ..... | P.579 |

تلفن شبانه روزی: ۰۲۱-۸۸۶۲۰۸۵

FarmaSOS.com

\*1: If equipped

\*2: The illustration shows the front, but they are also equipped in the rear.

# امداد خودرو فارما

تلفن شبانه روزی: ۰۲۱-۸۸۸۶۲۰۸۵

**FarmaSOS.com**

## For safety and security

## 1

<b>1-1. For safe use</b>	
Before driving.....	26
For safety drive.....	28
Seat belts .....	30
SRS airbags .....	36
Front passenger occupant classification system.....	47
Safety information for children.....	52
Child restraint systems .....	53
Installing child restraints.....	57
Exhaust gas precautions.....	67
<b>1-2. Theft deterrent system</b>	
Engine immobilizer system .....	68
Alarm.....	70

فارسا خودرو فارما  
تلفن: ۰۲۱-۸۸۶۲۰۸۵  
FarmaSOS.com

## Before driving

### Floor mat

Use only floor mats designed specifically for vehicles of the same model and model year as your vehicle. Fix them securely in place onto the carpet.

- 1 Insert the retaining hooks (clips) into the floor mat eyelets.

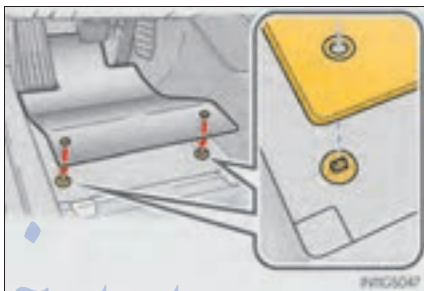

- 2 Turn the upper knob of each retaining hook (clip) to secure the floor mats in place.

\*: Always align the  $\triangle$  marks.

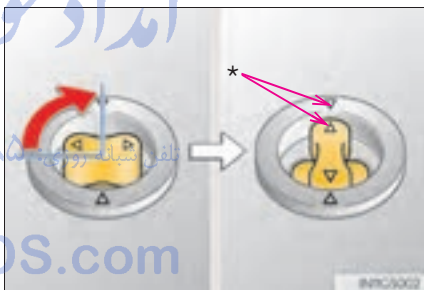

The shape of the retaining hooks (clips) may differ from that shown in the illustration.



**⚠ CAUTION**

Observe the following precautions.

Failure to do so may cause the driver's floor mat to slip, possibly interfering with the pedals while driving. An unexpectedly high speed may result or it may become difficult to stop the vehicle, leading to an accident, or leading to death or a serious injury.

**■ When installing the driver's floor mat**

- Do not use floor mats designed for other models or different model year vehicles, even if they are Lexus Genuine floor mats.
- Only use floor mats designed for the driver's seat.
- Always install the floor mat securely using the retaining hooks (clips) provided.
- Do not use two or more floor mats on top of each other.
- Do not place the floor mat bottom-side up or upside-down.

**■ Before driving**

- Check that the floor mat is securely fixed in the correct place with all the provided retaining hooks (clips). Be especially careful to perform this check after cleaning the floor.
- With the engine stopped and the shift lever in P, fully depress each pedal to the floor to make sure it does not interfere with the floor mat.



## For safety drive

For safe driving, adjust the seat and mirror to an appropriate position before driving.

### Correct driving posture

- ① Adjust the angle of the seatback so that you are sitting straight up and so that you do not have to lean forward to steer. (→P. 128)
- ② Adjust the seat so that you can depress the pedals fully and so that your arms bend slightly at the elbow when gripping the steering wheel. (→P. 128)
- ③ Lock the head restraint in place with the center of the head restraint closest to the top of your ears. (→P. 136)
- ④ Wear the seat belt correctly. (→P. 30)

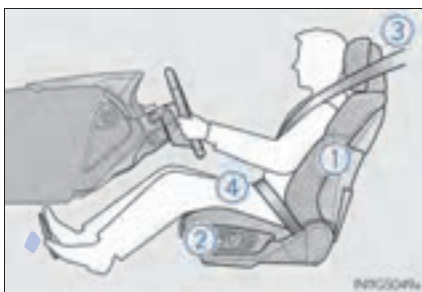

### Correct use of the seat belts

Make sure that all occupants are wearing their seat belts before driving the vehicle. (→P. 30)

Use a child restraint system appropriate for the child until the child becomes large enough to properly wear the vehicle's seat belt. (→P. 53)

## Adjusting the mirrors

Make sure that you can see backward clearly by adjusting the inside and outside rear view mirrors properly. (→P. 140, 142)

### CAUTION

Observe the following precautions.

Failure to do so may result in death or serious injury.

- Do not adjust the position of the driver's seat while driving.  
Doing so could cause the driver to lose control of the vehicle.
- Do not place a cushion between the driver or passenger and the seatback.  
A cushion may prevent correct posture from being achieved, and reduce the effectiveness of the seat belt and head restraint.
- Do not place anything under the front seats.  
Objects placed under the front seats may become jammed in the seat tracks and stop the seat from locking in place. This may lead to an accident and the adjustment mechanism may also be damaged.
- When driving over long distances, take regular breaks before you start to feel tired.  
Also, if you feel tired or sleepy while driving, do not force yourself to continue driving and take a break immediately.

FarmaSOS.com

## Seat belts

Make sure that all occupants are wearing their seat belts before driving the vehicle.

### Correct use of the seat belts

- Extend the shoulder belt so that it comes fully over the shoulder, but does not come into contact with the neck or slide off the shoulder.
- Position the lap belt as low as possible over the hips.
- Adjust the position of the seat-back. Sit up straight and well back in the seat.
- Do not twist the seat belt.



تلفن شبانه روزی: ۰۲۱-۸۸۶۲۰۸۵

### Fastening and releasing the seat belt

- ① To fasten the seat belt, push the plate into the buckle until a click sound is heard.
- ② To release the seat belt, press the release button.

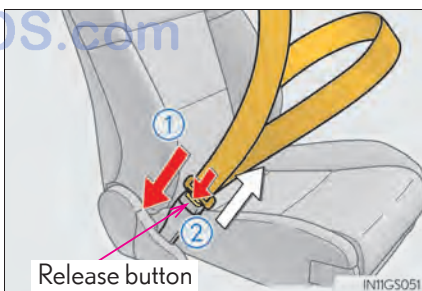

## Adjusting the seat belt shoulder anchor height (front seats)

- ① Push the seat belt shoulder anchor down while pressing the release button.
  - ② Push the seat belt shoulder anchor up.
- Move the height adjuster up and down as needed until you hear a click.



## Seat belt comfort guide (outboard rear seats)

For children or smaller-than-average people, slide the seat belt comfort guide forward so that the shoulder belt does not sit close to the person's neck.

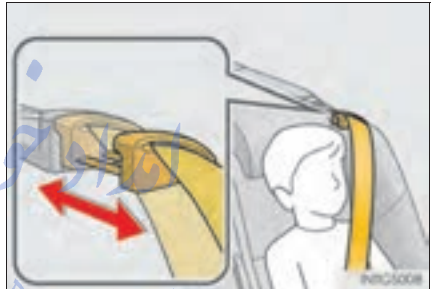

تلفن شبانه روزی: ۰۲۱-۸۸۶۲۰۸۵

## Seat belt pretensioners (front and outboard rear seats)

The pretensioner helps the seat belt to quickly restrain the occupant by retracting the seat belt when the vehicle is subjected to certain types of severe frontal collision.

The front seat pretensioners also activate when the vehicle is subjected to certain types of severe side collision.

The pretensioner does not activate in the event of a minor frontal impact, a minor side impact, a rear impact or a vehicle rollover.

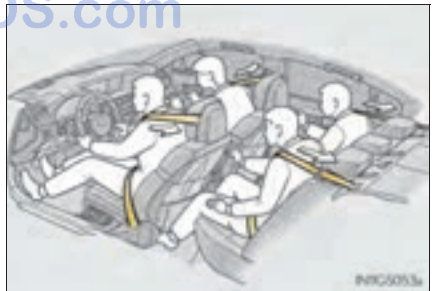

## Pre-collision seat belts (front seats of vehicles with pre-collision system)

If the pre-collision sensor detects that a collision is unavoidable, the pre-collision system will retract the seat belt before the collision occurs. (→P. 278)

### ■ Emergency locking retractor (ELR)

The retractor will lock the belt during a sudden stop or on impact. It may also lock if you lean forward too quickly. A slow, easy motion will allow the belt to extend so that you can move around fully.

### ■ Automatic locking retractor (ALR)

When a passenger's shoulder belt is completely extended and then retracted even slightly, the belt is locked in that position and cannot be extended. This feature is used to hold the child restraint system (CRS) firmly. To free the belt again, fully retract the belt and then pull the belt out once more. (→P. 57)

### ■ Child seat belt usage

The seat belts of your vehicle were principally designed for persons of adult size.

- Use a child restraint system appropriate for the child, until the child becomes large enough to properly wear the vehicle's seat belt. (→P. 53)
- When the child becomes large enough to properly wear the vehicle's seat belt, follow the instructions regarding seat belt usage. (→P. 30)

### ■ Replacing the belt after the pretensioner has been activated

If the vehicle is involved in multiple collisions, the pretensioner will activate for the first collision, but will not activate for the second or subsequent collisions.

### ■ Seat belt extender

If your seat belts cannot be fastened securely because they are not long enough, a personalized seat belt extender is available from your Lexus dealer free of charge.



## ⚠ CAUTION

Observe the following precautions to reduce the risk of injury in the event of sudden braking, sudden swerving or an accident.

Failure to do so may cause death or serious injury.

### ■ Wearing a seat belt

- Ensure that all passengers wear a seat belt.
- Always wear a seat belt properly.
- Each seat belt should be used by one person only. Do not use a seat belt for more than one person at once, including children.
- Lexus recommends that children be seated in the rear seat and always use a seat belt and/or an appropriate child restraint system.
- To achieve a proper seating position, do not recline the seat more than necessary. The seat belt is most effective when the occupants are sitting up straight and well back in the seats.
- Do not wear the shoulder belt under your arm.
- Always wear your seat belt low and snug across your hips.

### ■ Pregnant women

Obtain medical advice and wear the seat belt in the proper way. (→P. 30)

Women who are pregnant should position the lap belt as low as possible over the hips in the same manner as other occupants, extending the shoulder belt completely over the shoulder and avoiding belt contact with the rounding of the abdominal area.

If the seat belt is not worn properly, not only the pregnant woman, but also the fetus could suffer death or serious injury as a result of sudden braking or a collision.



**⚠ CAUTION****■ People suffering illness**

Obtain medical advice and wear the seat belt in the proper way. (→P. 30)

**■ When children are in the vehicle**

Do not allow children to play with the seat belt. If the seat belt becomes twisted around a child's neck, it may lead to choking or other serious injuries that could result in death.

If this occurs and the buckle cannot be unfastened, scissors should be used to cut the belt.

**■ Seat belt pretensioners**

If the pretensioner has activated, the SRS warning light will come on. In that case, the seat belt cannot be used again and must be replaced at your Lexus dealer.

**■ Adjustable shoulder anchor**

Always make sure the shoulder belt is positioned across the center of your shoulder. The belt should be kept away from your neck, but not falling off your shoulder. Failure to do so could reduce the amount of protection in an accident and cause death or serious injuries in the event of a sudden stop, sudden swerve or accident. (→P. 31)

**■ Seat belt damage and wear**

- Do not damage the seat belts by allowing the belt, plate, or buckle to be jammed in the door.
- Inspect the seat belt system periodically. Check for cuts, fraying, and loose parts. Do not use a damaged seat belt until it is replaced. Damaged seat belts cannot protect an occupant from death or serious injury.
- Ensure that the belt and plate are locked and the belt is not twisted. If the seat belt does not function correctly, immediately contact your Lexus dealer.
- Replace the seat assembly, including the belts, if your vehicle has been involved in a serious accident, even if there is no obvious damage.
- Do not attempt to install, remove, modify, disassemble or dispose of the seat belts. Have any necessary repairs carried out by your Lexus dealer. Inappropriate handling may lead to incorrect operation.



 CAUTION**■ Using a seat belt extender**

- Do not wear the seat belt extender if you can fasten the seat belt without the extender.
- Do not use the seat belt extender when installing a child restraint system because the belt will not securely hold the child restraint system, increasing the risk of death or serious injury in the event of an accident.
- The personalized extender may not be safe on another vehicle, when used by another person, or at a different seating position other than the one originally intended.

 NOTICE**■ When using a seat belt extender**

When releasing the seat belt, press on the buckle release button on the extender, not on the seat belt. *امداد خود و فارما*  
This helps prevent damage to the vehicle interior and the extender itself.

تلفن شبانه روزی: ۰۲۱-۸۸۶۲۰۸۵

FarmaSOS.com

## SRS airbags

The SRS airbags inflate when the vehicle is subjected to certain types of severe impacts that may cause significant injury to the occupants. They work together with the seat belts to help reduce the risk of death or serious injury.

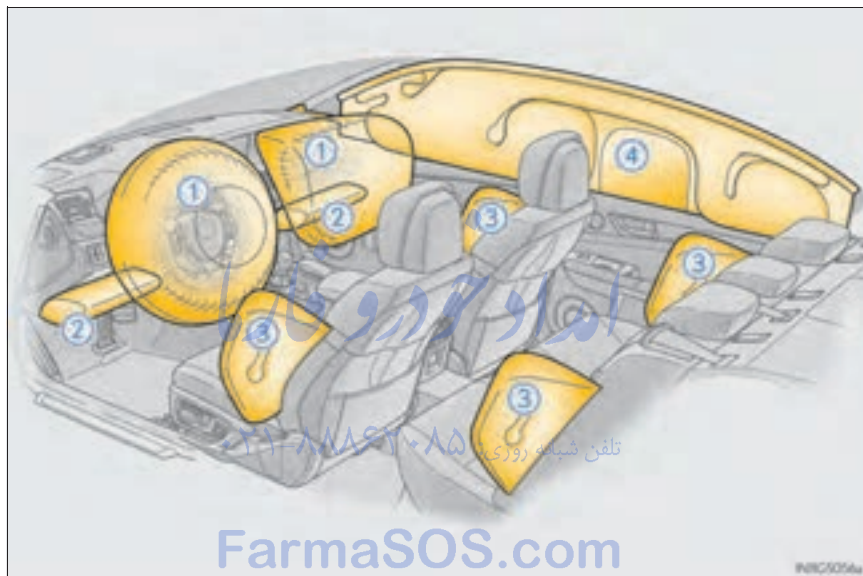

### ◆ SRS front airbags

- ① SRS driver airbag/front passenger airbag  
Can help protect the head and chest of the driver and front passenger from impact with interior components
- ② SRS knee airbags  
Can help provide driver and front passenger protection  
An SRS knee airbag for the front passenger's seat is built into the glove box door.

### ◆ SRS side and curtain shield airbags

- ③ SRS front side airbags  
Can help protect the torso of the front seat occupants
- SRS rear side airbags  
Can help protect the torso of occupants in the rear outer seats
- ④ SRS curtain shield airbags  
Can help protect primarily the head of occupants in the outer seats

امداد خودرو فارما

تلفن شبانه روزی: ۰۲۱-۸۸۸۶۲۰۸۵

FarmaSOS.com

## SRS airbag system components

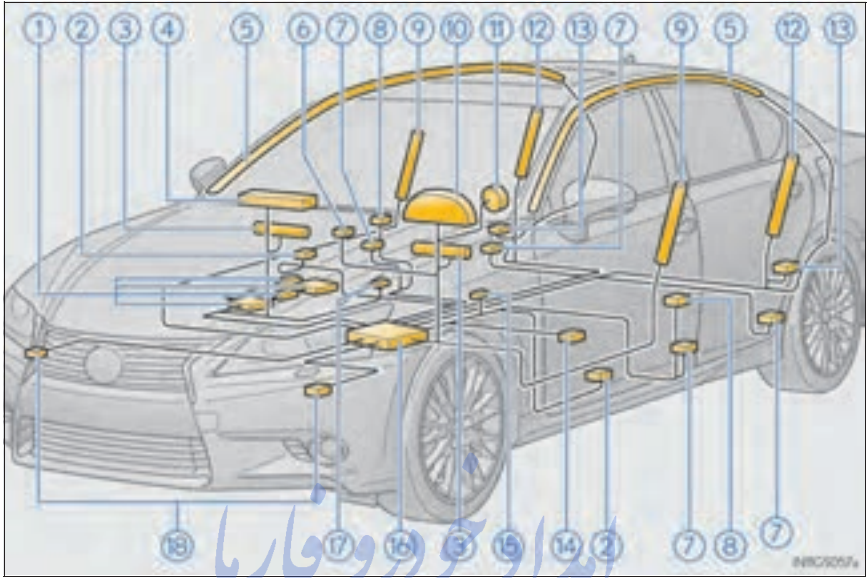

- |  |   |
|--|---|
| ① Front passenger occupant classification system (ECU and sensors) | ⑨ Front side airbags                        |
| ② Side impact sensors (front doors)                                | ⑩ SRS warning light                         |
| ③ Knee airbags   | ⑪ Driver airbag                             |
| ④ Front passenger airbag   | ⑫ Rear side airbags                         |
| ⑤ Curtain shield airbags   | ⑬ Side impact sensors (rear)                |
| ⑥ "AIR BAG ON" and "AIR BAG OFF" indicator lights                  | ⑭ Driver's seat position sensor             |
| ⑦ Seat belt pretensioners and force limiters                       | ⑮ Driver's seat belt buckle switch          |
| ⑧ Side impact sensors (front)                                      | ⑯ Airbag sensor assembly                    |
|  | ⑰ Front passenger's seat belt buckle switch |
|  | ⑱ Front impact sensors                      |

Your vehicle is equipped with ADVANCED AIRBAGS designed based on the US motor vehicle safety standards (FMVSS208). The airbag sensor assembly (ECU) controls airbag deployment based on information obtained from the sensors etc. shown in the system components diagram above. This information includes crash severity and occupant information. As the airbags deploy, a chemical reaction in the inflators quickly fills the airbags with non-toxic gas to help restrain the motion of the occupants.

## CAUTION

### ■ SRS airbag precautions

Observe the following precautions regarding the SRS airbags.

Failure to do so may cause death or serious injury.

- The driver and all passengers in the vehicle must wear their seat belts properly. The SRS airbags are supplemental devices to be used with the seat belts.
- The SRS driver airbag deploys with considerable force, and can cause death or serious injury especially if the driver is very close to the airbag. The National Highway Traffic Safety Administration (NHTSA) advises:

Since the risk zone for the driver's airbag is the first 2 - 3 in. (50 - 75 mm) of inflation, placing yourself 10 in. (250 mm) from your driver airbag provides you with a clear margin of safety. This distance is measured from the center of the steering wheel to your breastbone. If you sit less than 10 in. (250 mm) away now, you can change your driving position in several ways:

- Move your seat to the rear as far as you can while still reaching the pedals comfortably.
- Slightly recline the back of the seat. Although vehicle designs vary, many drivers can achieve the 10 in. (250 mm) distance, even with the driver seat all the way forward, simply by reclining the back of the seat somewhat. If reclining the back of your seat makes it hard to see the road, raise yourself by using a firm, non-slippery cushion, or raise the seat if your vehicle has that feature.
- If your steering wheel is adjustable, tilt it downward. This points the airbag toward your chest instead of your head and neck.

The seat should be adjusted as recommended by NHTSA above, while still maintaining control of the foot pedals, steering wheel, and your view of the instrument panel controls.

## ⚠ CAUTION

### ■ SRS airbag precautions

- If the seat belt extender has been connected to the front seat belt buckle but the seat belt extender has not also been fastened to the latch plate of the seat belt, the SRS front airbags will judge that the driver and front passenger are wearing the seat belt even though the seat belt has not been connected. In this case, the SRS front airbags may not activate correctly in a collision, resulting in death or serious injury in the event of a collision. Be sure to wear the seat belt with the seat belt extender.
- The SRS front passenger airbag also deploys with considerable force, and can cause death or serious injury especially if the front passenger is very close to the airbag. The front passenger seat should be as far from the airbag as possible with the seatback adjusted, so the front passenger sits upright.
- Improperly seated and/or restrained infants and children can be killed or seriously injured by a deploying airbag. An infant or child who is too small to use a seat belt should be properly secured using a child restraint system. Lexus strongly recommends that all infants and children be placed in the rear seats of the vehicle and properly restrained. The rear seats are safer for infants and children than the front passenger seat. (→P. 53)
- Do not sit on the edge of the seat or lean against the dashboard.



## ⚠ CAUTION

### ■ SRS airbag precautions

- Do not allow a child to stand in front of the SRS front passenger airbag unit or sit on the knees of a front passenger.
- Do not allow the front seat occupants to hold items on their knees.



- Do not lean against the door, the roof side rail or the front, side and rear pillars.



- Do not allow anyone to kneel on the passenger seats toward the door or put their head or hands outside the vehicle.



- Do not attach anything to or lean anything against areas such as the dashboard, steering wheel pad, lower portion of the instrument panel and door of the glove box. These items can become projectiles when the SRS driver, front passenger and knee airbags deploy.

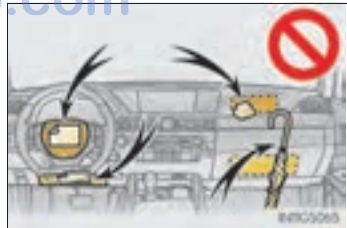

- Do not attach anything to areas such as a door, windshield glass, side door glass, front or rear pillar, roof side rail and assist grip.



**⚠ CAUTION****■ SRS airbag precautions**

- Do not hang coat hangers or hard objects on the coat hooks. All of these items could become projectiles and may cause death or serious injury, should the SRS curtain shield airbags deploy.
- If a vinyl cover is put on the area where the SRS knee airbag will deploy, be sure to remove it.
- Do not use seat accessories which cover the parts where the SRS side airbags inflate as they may interfere with inflation of the airbags. Such accessories may prevent the side airbags from activating correctly, disable the system or cause the side airbags to inflate accidentally, resulting in death or serious injury.
- Do not strike or apply significant levels of force to the area of the SRS airbag components.  
Doing so can cause the SRS airbags to malfunction.
- Do not touch any of the component parts immediately after the SRS airbags have deployed (inflated) as they may be hot.
- If breathing becomes difficult after the SRS airbags have deployed, open a door or window to allow fresh air in, or leave the vehicle if it is safe to do so. Wash off any residue as soon as possible to prevent skin irritation.
- If the areas where the SRS airbags are stored, such as the steering wheel pad, door of the glove box and front and rear pillar garnishes are damaged or cracked, have them replaced by your Lexus dealer.



## CAUTION

### ■ Modification and disposal of SRS airbag system components

Do not dispose of your vehicle or perform any of the following modifications without consulting your Lexus dealer. The SRS airbags may malfunction or deploy (inflate) accidentally, causing death or serious injury.

- Installation, removal, disassembly and repair of the SRS airbags
- Repairs, modifications, removal or replacement of the steering wheel, instrument panel, dashboard, glove box, seats or seat upholstery, front, side and rear pillars or roof side rails
- Repairs or modifications of the front fender, front bumper, or side of the occupant compartment
- Installation of snow plows, winches, etc. to the front grille (bull bars or kangaroo bar etc.)
- Modifications to the vehicle's suspension system
- Installation of electronic devices such as mobile two-way radios and CD players
- Modifications to your vehicle for a person with a physical disability

### ■ If the SRS airbags deploy (inflate)

- Bruising and slight abrasions may result from contact with a deploying (inflating) SRS airbag.
- A loud noise and white powder will be emitted.
- Parts of the airbag module (steering wheel hub, airbag cover and inflator) as well as the seats, the glove box, parts of the front and rear pillars, and roof side rails may be hot for several minutes. The airbag itself may also be hot.
- The windshield may crack.
- For Safety Connect subscribers, if the SRS airbags deploy or in the event of a severe rear-end collision, the system is designed to send an emergency call to the response center, notifying them of the vehicle's location (without needing to push the "SOS" button) and an agent will attempt to speak with the occupants to ascertain the level of emergency and assistance required. If the occupants are unable to communicate, the agent automatically treats the call as an emergency and helps to dispatch the necessary emergency services. (→P. 586)

### ■ SRS airbag deployment conditions (SRS front airbags)

- The SRS front airbags will deploy in the event of an impact that exceeds the set threshold level (the level of force corresponding to an approximately 12 - 18 mph [20 - 30 km/h] frontal collision with a fixed wall that does not move or deform).

However, this threshold velocity will be considerably higher in the following situations:

- If the vehicle strikes an object, such as a parked vehicle or sign pole, which can move or deform on impact
- If the vehicle is involved in an underride collision, such as a collision in which the front of the vehicle "underrides", or goes under, the bed of a truck
- Depending on the type of collision, it is possible that only the seat belt pretensioners will activate.
- The SRS front airbags for the front passenger will not activate if there is no passenger sitting in the front passenger seat. However, the SRS front airbags for the front passenger may deploy if luggage is put in the seat, even if the seat is unoccupied. (→P. 47)

### ■ SRS airbag deployment conditions (SRS side and curtain shield airbags)

- The SRS side and curtain shield airbags will deploy in the event of an impact that exceeds the set threshold level (the level of force corresponding to the impact force produced by an approximately 3300 lb. [1500 kg] vehicle colliding with the vehicle cabin from a direction perpendicular to the vehicle orientation at an approximate speed of 12 - 18 mph [20 - 30 km/h]).
- The SRS curtain shield airbags may also deploy in the event of a severe frontal collision.

### ■ Conditions under which the SRS airbags may deploy (inflate), other than a collision

The SRS front airbags may also deploy if a serious impact occurs to the underside of your vehicle. Some examples are shown in the illustration.

- Hitting a curb, edge of pavement or hard surface
- Falling into or jumping over a deep hole
- Landing hard or falling

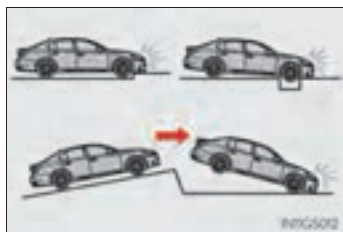

### ■ Types of collisions that may not deploy the SRS airbags (SRS front airbags)

The SRS front airbags do not generally inflate if the vehicle is involved in a side or rear collision, if it rolls over, or if it is involved in a low-speed frontal collision. But, whenever a collision of any type causes sufficient forward deceleration of the vehicle, deployment of the SRS front airbags may occur.

- Collision from the side
- Collision from the rear
- Vehicle rollover

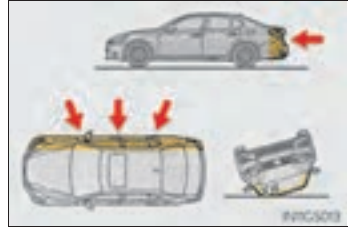

### ■ Types of collisions that may not deploy the SRS airbags (SRS side and curtain shield airbags)

The SRS side and curtain shield airbags may not activate if the vehicle is subjected to a collision from the side at certain angles, or a collision to the side of the vehicle body other than the passenger compartment.

- Collision from the side to the vehicle body other than the passenger compartment
- Collision from the side at an angle



The SRS side and curtain shield airbags do not generally inflate if the vehicle is involved in a frontal or rear collision, if it rolls over, or if it is involved in a low-speed side collision.

- Collision from the front\*
- Collision from the rear
- Vehicle rollover

\*: Depending on the conditions and type of accident, the curtain shield airbags may deploy (inflate) upon frontal impact.

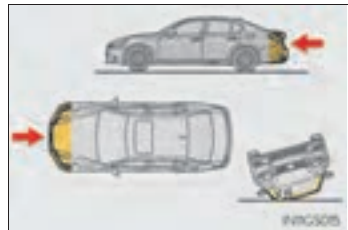

### ■ When to contact your Lexus dealer

In the following cases, the vehicle will require inspection and/or repair. Contact your Lexus dealer as soon as possible.

- Any of the SRS airbags have been inflated.
- The front of the vehicle is damaged or deformed, or was involved in an accident that was not severe enough to cause the SRS airbags to inflate.

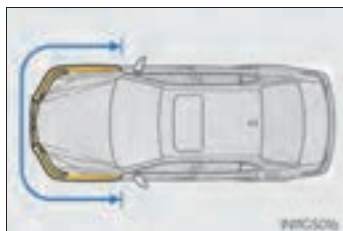

- A portion of a door is damaged or deformed, or the vehicle was involved in an accident that was not severe enough to cause the SRS side and curtain shield airbags to inflate.

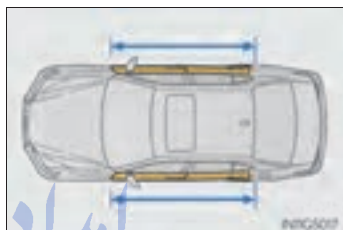

- The pad section of the steering wheel, dashboard near the front passenger airbag, lower portion of the instrument panel or door of the glove box is scratched, cracked, or otherwise damaged.

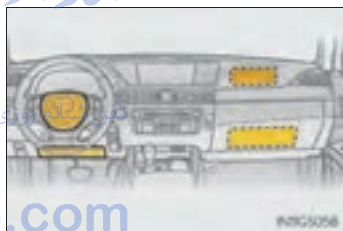

- The surface of the seats with the side airbag is scratched, cracked, or otherwise damaged.

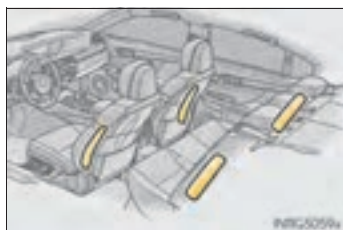

- The portion of the front pillars, rear pillars or roof side rail garnishes (padding) containing the curtain shield airbags inside is scratched, cracked, or otherwise damaged.



امداد خودرو فارما

FarmaSOS.com

## Front passenger occupant classification system

Your vehicle is equipped with a front passenger occupant classification system. This system detects the conditions of the front passenger seat and activates or deactivates the devices for the front passenger.



- ① Seat belt reminder light
- ② SRS warning light
- ③ "AIR BAG OFF" indicator light
- ④ "AIR BAG ON" indicator light

## Condition and operation in the front passenger occupant classification system

### ■ Adult\*<sup>1</sup>

Indicator/ warning light	"AIR BAG ON" and "AIR BAG OFF" indicator lights	"AIR BAG ON"
	SRS warning light	Off
	Seat belt reminder light	Flashing* <sup>2</sup>
Devices	Front passenger airbag	Activated
	Side airbag on the front passenger seat	
	Curtain shield airbag in the front passenger side	
	Front passenger knee airbag	
	Front passenger's seat belt pretensioner	

### ■ Child\*<sup>3</sup> or child restraint system\*<sup>4</sup>

Indicator/ warning light	"AIR BAG ON" and "AIR BAG OFF" indicator lights	"AIR BAG OFF"* <sup>5</sup>
	SRS warning light	Off
	Seat belt reminder light	Flashing* <sup>2</sup>
Devices	Front passenger airbag	Deactivated
	Side airbag on the front passenger seat	Activated
	Curtain shield airbag in the front passenger side	
	Front passenger knee airbag	Deactivated
	Front passenger's seat belt pretensioner	Activated

## ■ Unoccupied

Indicator/ warning light	"AIR BAG ON" and "AIR BAG OFF" indicator lights	Not illuminated
	SRS warning light	Off
	Seat belt reminder light	
Devices	Front passenger airbag	Deactivated
	Side airbag on the front passenger seat	Activated
	Curtain shield airbag in the front passenger side	
	Front passenger knee airbag	Deactivated
	Front passenger's seat belt pretensioner	

## ■ There is a malfunction in the system

Indicator/ warning light	"AIR BAG ON" and "AIR BAG OFF" indicator lights	"AIR BAG OFF"
	SRS warning light	On
	Seat belt reminder light	Off
Devices	Front passenger airbag	Deactivated
	Side airbag on the front passenger seat	Activated
	Curtain shield airbag in the front passenger side	
	Front passenger knee airbag	Deactivated
	Front passenger's seat belt pretensioner	Activated

- \*1: The system judges a person of adult size as an adult. When a smaller adult sits in the front passenger seat, the system may recognize him/her as a child depending on his/her physique and posture.
- \*2: In the event the front passenger does not wear a seat belt
- \*3: When a larger child who has outgrown a child restraint system sits in the front passenger seat, the system may recognize him/her as an adult depending on his/her physique or posture.
- \*4: Never install a rear-facing child restraint system on the front passenger seat. A forward-facing child restraint system should only be installed on the front passenger seat when it is unavoidable. (→P. 53)
- \*5: In case the indicator light is not illuminated, consult this manual on how to install the child restraint system properly. (→P. 57)



## CAUTION

### ■ Front passenger occupant classification system precautions

Observe the following precautions regarding the front passenger occupant classification system.

Failure to do so may cause death or serious injury.

- Wear the seat belt properly.
- Make sure the front passenger's seat belt plate has not been left inserted into the buckle before someone sits in the front passenger seat.
- Make sure the "AIR BAG OFF" indicator light is not illuminated when using the seat belt extender for the front passenger seat. If the "AIR BAG OFF" indicator light is illuminated, disconnect the extender tongue from the seat belt buckle, and reconnect the seat belt. Reconnect the seat belt extender after making sure the "AIR BAG ON" indicator light is illuminated. If you use the seat belt extender while the "AIR BAG OFF" indicator light is illuminated, the SRS airbags for the passenger may not activate correctly, which could cause death or serious injury in the event of a collision.
- Do not apply a heavy load to the front passenger seat or equipment (e.g. seat-back pockets or armrest).
- Do not put weight on the front passenger seat by putting your hands or feet on the front passenger seat seatback from the rear passenger seat.
- Do not let a rear passenger lift the front passenger seat with their feet or press on the seatback with their legs.
- Do not put objects under the front passenger seat.



 CAUTION**■ Front passenger occupant classification system precautions**

- Do not recline the front passenger seatback so far that it touches a rear seat. This may cause the “AIR BAG OFF” indicator light to be illuminated, which indicates that the passenger’s airbags will not deploy in the event of a severe accident. If the seatback touches the rear seat, return the seatback to a position where it does not touch the rear seat. Keep the front passenger seatback as upright as possible when the vehicle is moving. Reclining the seatback excessively may lessen the effectiveness of the seat belt system.
- If an adult sits in the front passenger seat, the “AIR BAG ON” indicator light is illuminated. If the “AIR BAG OFF” indicator is illuminated, ask the passenger to sit up straight, well back in the seat, feet on the floor, and with the seat belt worn correctly. If the “AIR BAG OFF” indicator still remains illuminated, either ask the passenger to move to the rear seat, or if that is not possible, move the front passenger seat fully rearward.
- When it is unavoidable to install a forward-facing child restraint system on the front passenger seat, install the child restraint system on the front passenger seat in the proper order. (→P. 57)
- Do not modify or remove the front seats.
- Do not kick the front passenger seat or subject it to severe impact. Otherwise, the SRS warning light may come on to indicate a malfunction of the detection system. In this case, contact your Lexus dealer immediately.
- Child restraint systems installed on the rear seat should not contact the front seatbacks.
- Do not modify or replace the upholstery of the front seat.

## Safety information for children

Observe the following precautions when children are in the vehicle. Use a child restraint system appropriate for the child, until the child becomes large enough to properly wear the vehicle's seat belt.

- It is recommended that children sit in the rear seats to avoid accidental contact with the shift lever, wiper switch etc.
- Use the rear door child-protector lock or the window lock switch to avoid children opening the door while driving or operating the power window accidentally.
- Do not let small children operate equipment which may catch or pinch body parts, such as the power window, hood, trunk, seats etc.

### CAUTION

Never leave children unattended in the vehicle, and never allow children to have or use the key.

Children may be able to start the vehicle or shift the vehicle into neutral. There is also a danger that children may injure themselves by playing with the windows, the moon roof or other features of the vehicle. In addition, heat build-up or extremely cold temperatures inside the vehicle can be fatal to children.

## Child restraint systems

A child restraint system for a small child or baby must itself be properly restrained on the seat with the lap portion of the lap/shoulder belt.

The laws of all 50 states of the U.S.A. and Canada now require the use of child restraint systems.

### Points to remember

Studies have shown that installing a child restraint on a rear seat is much safer than installing one on the front passenger seat.

- Choose a child restraint system that suits your vehicle and is appropriate to the age and size of the child.
- For installation details, follow the instructions provided with the child restraint system.

General installation instructions are provided in this manual. (→P. 57)

تلفن شبانه روزی: ۰۲۱-۸۸۶۲۰۸۵

FarmaSOS.com

## Types of child restraints

Child restraint systems are classified into the following 3 types according to the age and size of the child:

- ▶ Rear facing — Infant seat/convertible seat
- ▶ Forward facing — Convertible seat



- ▶ Booster seat



### ■ Selecting an appropriate child restraint system

- Use a child restraint system appropriate for the child until the child becomes large enough to properly wear the vehicle's seat belt.
- If the child is too large for a child restraint system, sit the child on a rear seat and use the vehicle's seat belt. (→P. 30)

 CAUTION**■ Child restraint precautions**

- For effective protection in automobile accidents and sudden stops, a child must be properly restrained, using a seat belt or child restraint system depending on the age and size of the child. Holding a child in your arms is not a substitute for a child restraint system. In an accident, the child can be crushed against the windshield, or between you and the vehicle's interior.
- Lexus strongly urges the use of a proper child restraint system that conforms to the size of the child, installed on the rear seat. According to accident statistics, the child is safer when properly restrained in the rear seat than in the front seat.
- Never install a rear-facing child restraint system on the front passenger seat even if the "AIR BAG OFF" indicator light is illuminated.  
In the event of an accident, the force of the rapid inflation of the front passenger airbag can cause death or serious injury to the child if the rear-facing child restraint system is installed on the front passenger seat.
- A forward-facing child restraint system may be installed on the front passenger seat only when it is unavoidable. A child restraint system that requires a top tether strap should not be used in the front passenger seat since there is no top tether strap anchor for the front passenger seat. Adjust the seatback as upright as possible and always move the seat as far back as possible even if the "AIR BAG OFF" indicator light is illuminated, because the front passenger airbag could inflate with considerable speed and force. Otherwise, the child may be killed or seriously injured.
- Do not use the seat belt extender when installing a child restraint system on the front or rear passenger seat. If installing a child restraint system with the seat belt extender connected to the seat belt, the seat belt will not securely hold the child restraint system, which could cause death or serious injury to the child or other passengers in the event of an accident.
- Do not allow the child to lean his/her head or any part of his/her body against the door or the area of the seat, front and rear pillars or roof side rails from which the SRS side airbags or SRS curtain shield airbags deploy even if the child is seated in the child restraint system. It is dangerous if the SRS side airbags and curtain shield airbags inflate, and the impact could cause death or serious injury to the child.
- Make sure you have complied with all installation instructions provided by the child restraint manufacturer and that the system is properly secured. If it is not secured properly, it may cause death or serious injury to the child in the event of a sudden stop or accident.

 CAUTION**■ When children are in the vehicle**

Do not allow children to play with the seat belt. If the seat belt becomes twisted around a child's neck, it may lead to choking or other serious injuries that could result in death.

If this occurs and the buckle cannot be unfastened, scissors should be used to cut the belt.

**■ When the child restraint system is not in use**

- Keep the child restraint system properly secured on the seat even if it is not in use. Do not store the child restraint system unsecured in the passenger compartment.
- If it is necessary to detach the child restraint system, remove it from the vehicle or store it securely in the trunk. This will prevent it from injuring passengers in the event of a sudden stop or accident.

امداد خودرو فارما

تلفن شبانه روزی: ۰۲۱-۸۸۶۲۰۸۵

FarmaSOS.com

## Installing child restraints

Follow the child restraint system manufacturer's instructions. Firmly secure child restraints to the seats using the LATCH anchors or a seat belt. Attach the top tether strap when installing a child restraint. The lap/shoulder belt can be used if your child restraint system is not compatible with the LATCH (Lower Anchors and Tethers for Children) system.

### Child restraint LATCH anchors

LATCH anchors are provided for the outboard rear seats. (Buttons displaying the location of the anchors are attached to the seats.)

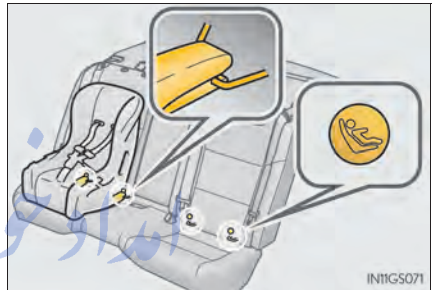

Seat belts equipped with a child restraint locking mechanism (ALR/ELR belts except driver's seat belt) (→P. 32)



Anchor brackets (for top tether strap)

An anchor bracket is provided for each rear seat.

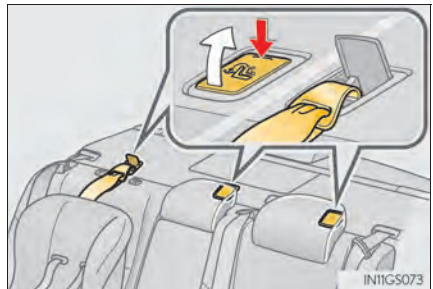

## Installation with LATCH system

- 1 Remove the head restraint.

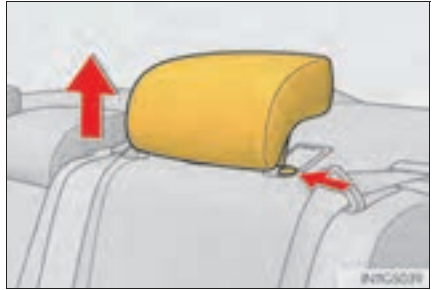

- 2 Widen the gap between the seat cushion and seatback slightly.

### ► Type A

- 3 Latch the hooks of the lower straps onto the LATCH anchors. If the child restraint has a top tether strap, the top tether strap should be latched onto the top tether strap anchor.

For owners in Canada:

The symbol on a child restraint system indicates the presence of a lower connector system.

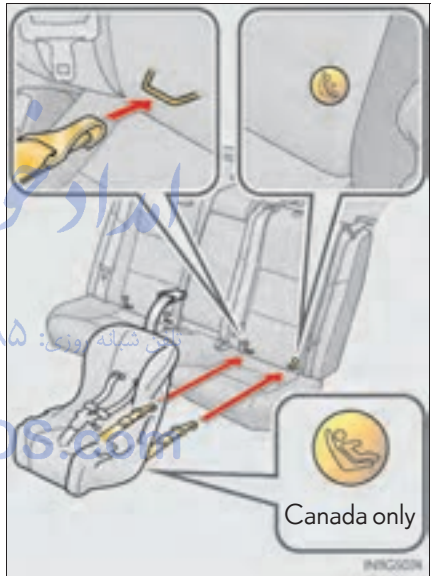



## ► Type B

- 3 Latch the buckles onto the LATCH anchors. If the child restraint has a top tether strap, the top tether strap should be latched onto the top tether strap anchor.

For owners in Canada:  
The symbol on a child restraint system indicates the presence of a lower connector system.

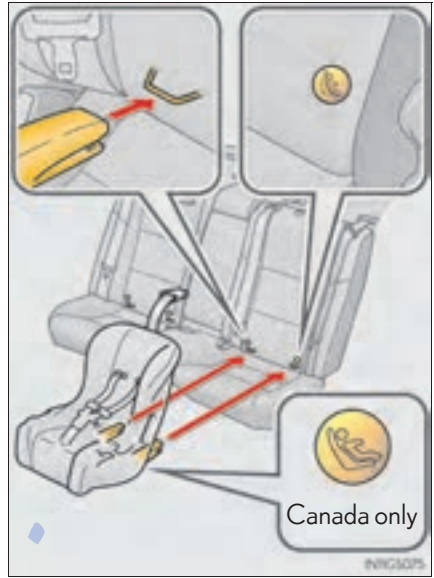

# امداد خودرو فارما

تلفن شبانه روزی: ۰۲۱-۸۸۸۶۲۰۸۵

[FarmaSOS.com](http://FarmaSOS.com)

## Installing child restraints using a seat belt (child restraint lock function belt)

### ■ Rear-facing — Infant seat/convertible seat

- 1** Place the child restraint system on the rear seat facing the rear of the vehicle.



- 2** Run the seat belt through the child restraint system and insert the plate into the buckle. Make sure that the belt is not twisted.

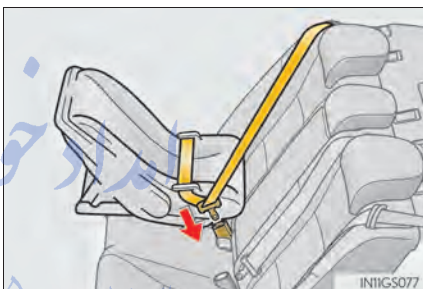

- 3** Fully extend the shoulder belt and allow it to retract to put it in lock mode. In lock mode, the belt cannot be extended.



- 4 While pushing the child restraint system down into the rear seat, allow the shoulder belt to retract until the child restraint system is securely in place.

After the shoulder belt has retracted to a point where there is no slack in the belt, pull the belt to check that it cannot be extended.

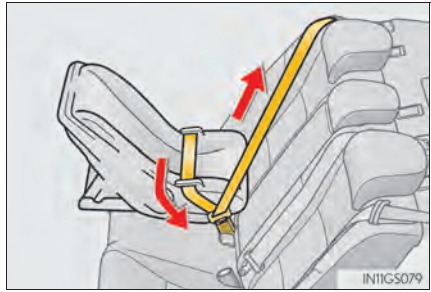

### ■ Forward-facing — Convertible seat

- 1 Rear outboard seats:  
Remove the head restraint.

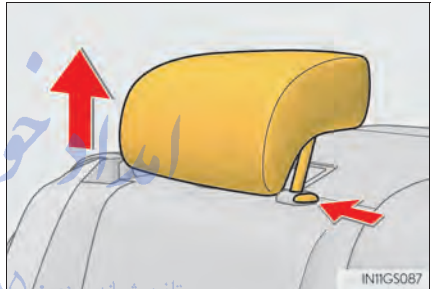

- 2 Place the child restraint system on the seat facing the front of the vehicle.



ایران خودرو فارما

تلفن شبانه روزی: ۰۲۱-۸۸۶۲۰۸۵

FarmaSOS.com

- 3** Run the seat belt through the child restraint system and insert the plate into the buckle. Make sure that the belt is not twisted.



- 4** Fully extend the shoulder belt and allow it to retract to put it in lock mode. In lock mode, the belt cannot be extended.



- 5** While pushing the child restraint system into the rear seat, allow the shoulder belt to retract until the child restraint system is securely in place.

After the shoulder belt has retracted to a point where there is no slack in the belt, pull the belt to check that it cannot be extended.



- 6** If the child restraint has a top tether strap, the top tether strap should be latched onto the top tether strap anchor. (→P. 64)

## ■ Booster seat

- 1 Place the child restraint system on the seat facing the front of the vehicle.

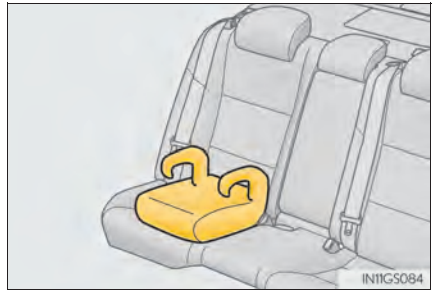

- 2 Sit the child in the child restraint system. Fit the seat belt to the child restraint system according to the manufacturer's instructions and insert the plate into the buckle. Make sure that the belt is not twisted.



Check that the shoulder belt is correctly positioned over the child's shoulder and that the lap belt is as low as possible. (→P. 30)

تلفن شبانه روزی: ۸۵۰۰۰۰۰۰۰۰۰۰۰

## Removing a child restraint installed with a seat belt

Push the buckle release button and fully retract the seat belt.



## Child restraint systems with a top tether strap

- 1 Rear outboard seats:  
Remove the head restraint.

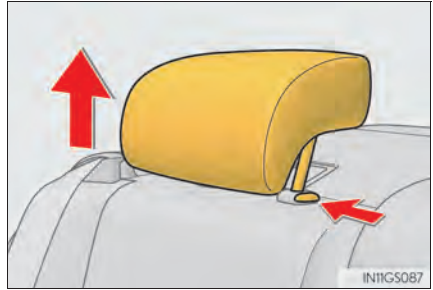

- 2 Secure the child restraint system using the seat belt or LATCH anchors.

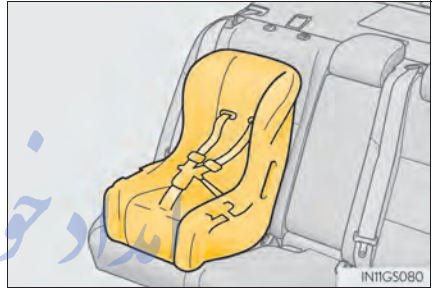

- 3 Open the anchor bracket cover, latch the hook onto the anchor bracket and tighten the top tether strap.

Make sure the top tether strap is securely latched.



### ■ Laws and regulations pertaining to anchorages

The LATCH system conforms to FMVSS225 or CMVSS210.2.

Child restraint systems conforming to FMVSS213 or CMVSS213 specifications can be used.

This vehicle is designed to conform to the SAE J1819.

## ⚠ CAUTION

### ■ When installing a booster seat

To prevent the belt from going into ALR lock mode, do not fully extend the shoulder belt. ALR mode causes the belt to tighten only. This could cause injury or discomfort to the child. (→P. 32)

### ■ When installing a child restraint system

Follow the directions given in the child restraint system installation manual and fix the child restraint system securely in place.

If the child restraint system is not correctly fixed in place, the child or other passengers may be seriously injured or even killed in the event of a sudden braking or an accident.

- If the driver's seat interferes with the child restraint system and prevents it from being attached correctly, attach the child restraint system to the right-hand rear seat.

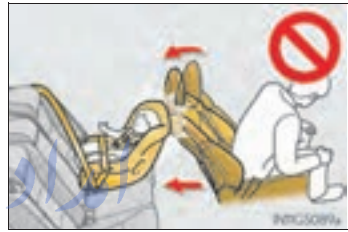

- Adjust the front passenger seat so that it does not interfere with the child restraint system.

- Only put a forward-facing child restraint system on the front seat when unavoidable. When installing a forward-facing child restraint system on the front passenger seat, move the seat as far back as possible even if the "AIR BAG OFF" indicator light is illuminated. Failure to do so may result in death or serious injury if the airbags deploy (inflate).



**⚠ CAUTION****■ When installing a child restraint system**

- When a booster seat is installed, always ensure that the shoulder belt is positioned across the center of the child's shoulder. The belt should be kept away from the child's neck, but not so that it could fall off the child's shoulder. Failing to do so may result in death or serious injury in the event of an accident or a sudden braking.
- Ensure that the belt and plate are securely locked and the seat belt is not twisted.
- Shake the child restraint system left and right, and forward and backward to ensure that it has been securely installed.
- After securing a child restraint system, never adjust the seat.
- Follow all installation instructions provided by the child restraint system manufacturer.

**■ Do not use a seat belt extender**

If a seat belt extender is used when installing a child restraint system, the seat belt will not securely hold the child restraint system, which could cause death or serious injury to the child or other passengers in the event of a sudden braking, sudden swerving or an accident.

**■ To correctly attach a child restraint system to the anchors**

When using the LATCH anchors, be sure that there are no foreign objects around the anchors and that the seat belt is not caught behind the child restraint system. Make sure the child restraint system is securely attached, or it may cause death or serious injury to the child or other passengers in the event of a sudden braking or an accident.



## Exhaust gas precautions

Harmful substance to the human body is included in exhaust gases if inhaled.

### CAUTION

Exhaust gases include harmful carbon monoxide (CO), which is colorless and odorless. Observe the following precautions.

Failure to do so may cause exhaust gases to enter the vehicle and may lead to an accident caused by light-headedness, or may lead to death or a serious health hazard.

#### ■ Important points while driving

- Keep the trunk lid closed.
- If you smell exhaust gases in the vehicle even when the trunk lid is closed, open the windows and have the vehicle inspected at your Lexus dealer as soon as possible.

#### ■ When parking

- If the vehicle is in a poorly ventilated area or a closed area, such as a garage, stop the engine.
- Do not leave the vehicle with the engine on for a long time.  
If such a situation cannot be avoided, park the vehicle in an open space and ensure that exhaust fumes do not enter the vehicle interior.
- Do not leave the engine running in an area with snow build-up, or where it is snowing. If snowbanks build up around the vehicle while the engine is running, exhaust gases may collect and enter the vehicle.

#### ■ Exhaust pipe

The exhaust system needs to be checked periodically. If there is a hole or crack caused by corrosion, damage to a joint or abnormal exhaust noise, be sure to have the vehicle inspected and repaired by your Lexus dealer.

## Engine immobilizer system

The vehicle's keys have built-in transponder chips that prevent the engine from starting if a key has not been previously registered in the vehicle's on-board computer.

**Never leave the keys inside the vehicle when you leave the vehicle.**

The indicator light flashes after the engine switch has been turned off to indicate that the system is operating.

The indicator light stops flashing after the engine switch has been turned to ACCESSORY or IGNITION ON mode to indicate that the system has been canceled.



### ■ System maintenance

The vehicle has a maintenance-free type engine immobilizer system.

### ■ Conditions that may cause the system to malfunction

- If the grip portion of the key is in contact with a metallic object
- If the key is in close proximity to or touching a key to the security system (key with a built-in transponder chip) of another vehicle

### ■ Certifications for the engine immobilizer system

- ▶ For vehicles sold in the U.S.A.

FCC ID: NI4TMIMB-3

This device complies with part 15 of the FCC Rules. Operation is subject to the following two conditions: (1) This device may not cause harmful interference, and (2) this device must accept any interference received, including interference that may cause undesired operation.

- ▶ For vehicles sold in Canada

Operation is subject to the following two conditions: (1) this device may not cause interference, and (2) this device must accept any interference, including interference that may cause undesired operation of the device.

### CAUTION

#### ■ Certifications for the engine immobilizer system

Changes or modifications not expressly approved by the party responsible for compliance could void the user's authority to operate the equipment.

### NOTICE

#### ■ To ensure the system operates correctly

Do not modify or remove the system. If modified or removed, the proper operation of the system cannot be guaranteed.

## Alarm

### The alarm

The alarm uses light and sound to give an alert when an intrusion is detected.

The alarm is triggered in the following situations when the alarm is set:

- A locked door or trunk is unlocked or opened in any way other than using the entry function, wireless remote control or mechanical key. (The doors will lock again automatically.)
- The hood is opened.

### Setting the alarm system

Close the doors, trunk and hood, and lock all the doors. The system will be set automatically after 30 seconds.

The indicator light changes from being on to flashing when the system is set.

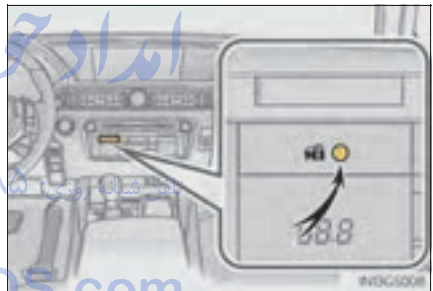

### Deactivating or stopping the alarm

Do one of the following to deactivate or stop the alarms:

- Unlock the doors or open the trunk.
- Turn the engine switch to ACCESSORY or IGNITION ON mode, or start the engine. (The alarm will be deactivated or stopped after a few seconds.)

### ■ System maintenance

The vehicle has a maintenance-free type alarm system.

### ■ Items to check before locking the vehicle

To prevent unexpected triggering of the alarm and vehicle theft, make sure of the following:

- Nobody is in the vehicle.
- The windows and moon roof are closed before the alarm is set.
- No valuables or other personal items are left in the vehicle.

### ■ Triggering of the alarm

The alarm may be triggered in the following situations:  
(Stopping the alarm deactivates the alarm system.)

- A person inside the vehicle opens a door, the trunk or hood.



- The battery is recharged or replaced when the vehicle is locked. (→P. 745)

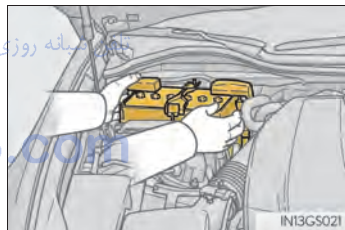

### ■ Alarm-operated door lock

When the alarm is operating, the doors are locked automatically to prevent intruders.

### ⚠ NOTICE

#### ■ To ensure the system operates correctly

Do not modify or remove the system. If modified or removed, the proper operation of the system cannot be guaranteed.

# امداد خودرو فارما

تلفن شبانه روزی: ۰۲۱-۸۸۸۶۲۰۸۵

[FarmaSOS.com](http://FarmaSOS.com)

**2. Instrument cluster**

Warning lights and indicators .....	74
Gauges and meters .....	79
Multi-information display .....	82
Head-up display .....	90

امداد خودرو فارما

تلفن شبانه روزی: ۰۲۱-۸۸۸۶۲۰۸۵

[FarmaSOS.com](http://FarmaSOS.com)

## Warning lights and indicators

The warning lights and indicators on the instrument cluster and center panel inform the driver of the status of the vehicle's various systems. For the purpose of explanation, the following illustration displays all warning lights and indicators illuminated.

### ◆ Instrument cluster



The units used on the speedometer and some indicators may differ depending on the target region. [FarmaSOS.com](http://FarmaSOS.com)

### ◆ Center panel







## Warning lights

Warning lights inform the driver of malfunctions in the indicated vehicle's systems.

<sup>*1</sup>  (U.S.A.)	Brake system warning light (→P. 686)	<sup>*1</sup> 	Slip indicator (→P. 688)
<sup>*1</sup>  (Canada)	Brake system warning light (→P. 686)	<sup>*1,2</sup>  (if equipped)	"AFS OFF" indicator (→P. 688)
<sup>*1</sup> 	Charging system warning light (→P. 687)	<sup>*2</sup>  (U.S.A.)	Parking brake indicator (→ P. 688)
<sup>*1</sup>  (U.S.A.)	Malfunction indicator lamp (→P. 687)	<sup>*2</sup>  (Canada)	Parking brake indicator (→P. 688)
<sup>*1</sup>  (Canada)	Malfunction indicator lamp (→P. 687)	<sup>*1</sup> 	Brake system warning light (→P. 689)
<sup>*1</sup> 	SRS warning light (→P. 687)	<sup>*1</sup> 	Open door warning light (→P. 689)
<sup>*1</sup>  (U.S.A.)	ABS warning light (→P. 687)	<sup>*1</sup> 	Low fuel level warning light (→P. 689)
<sup>*1</sup>  (Canada)	ABS warning light (→P. 687)	<sup>*1</sup> 	Seat belt reminder light (→P. 689)
<sup>*1</sup> 	Electric power steering system warning light (→P. 687)	<sup>*1</sup> 	Master warning light (→P. 689)

<sup>\*1,2</sup>  
 "PCS" warning light  
(→P. 687, 702)  
(if equipped)

<sup>\*1</sup>  
 Tire pressure warning light  
(→P. 690)

- \*1: These lights turn on when the engine switch is turned to IGNITION ON mode to indicate that a system check is being performed. They will turn off after the engine is on, or after a few seconds. There may be a malfunction in a system if the lights do not come on, or turn off. Have the vehicle inspected by your Lexus dealer.
- \*2: The light flashes to indicate a malfunction.

امداد خودرو فارما

تلفن شبانه روزی: ۰۲۱-۸۸۸۶۲۰۸۵

FarmaSOS.com

## Indicators

The indicators inform the driver of the operating state of the vehicle's various systems.

	Turn signal indicator (→P.184)		LKA (Lane-Keeping Assist) indicator (→P. 228)
	Headlight indicator (→P.190)		Intuitive parking assist indicator (→P. 238)
	Tail light indicator (→P.190)		*1 "AFS OFF" indicator (→P.192)
	Headlight high beam indicator (→P.191)		*1,2 Slip indicator (→P. 270, 276)
	Front fog light indicator (→P.195)		*1 VSC OFF indicator (→P. 276)
	Cruise control indicator (→P. 209, 213)		*1,3 "PCS" warning light (→P. 280)
	Radar cruise control indicator (→P. 213)		Parking brake indicator (→ P.186)
	Cruise control "SET" indicator (→P. 209, 213)		Parking brake indicator (→P.186)
			*1 "AIR BAG ON/OFF" indicator (→P. 47)

- \*1: These lights turn on when the engine switch is turned to IGNITION ON mode to indicate that a system check is being performed. They will turn off after the engine is on, or after a few seconds. There may be a malfunction in a system if the lights do not come on, or turn off. Have the vehicle inspected by your Lexus dealer.
- \*2: The light flashes to indicate that the system is operating.
- \*3: The light comes on when the system is turned off. The light flashes faster than usual to indicate that the system is operating.

**⚠ CAUTION****■ If a safety system warning light does not come on**

Should a safety system light such as the ABS and SRS warning light not come on when you start the engine, this could mean that these systems are not available to help protect you in an accident, which could result in death or serious injury. Have the vehicle inspected by your Lexus dealer immediately if this occurs.

امداد خودرو فارما

تلفن شبانه روزی: ۰۲۱-۸۸۶۲۰۸۵

FarmaSOS.com

## Gauges and meters



The units used on the speedometer may differ depending on the target region.

- ① Engine coolant temperature gauge  
Displays the engine coolant temperature
- ② Tachometer  
Displays the engine speed in revolutions per minute
- ③ ECO lamp and SPORT lamp  
Changes colors according to driving mode
- ④ Multi-information display  
Presents the driver with a variety of driving-related data (→P. 82)
- ⑤ Speedometer  
Displays the vehicle speed
- ⑥ Fuel gauge  
Displays the quantity of fuel remaining in the tank
- ⑦ Shift position and shift range  
Displays the selected shift position or selected shift range (→P. 178)

### ⑧ Odometer and trip meter display

Odometer:

Displays the total distance the vehicle has been driven

Trip meter:

Displays the distance the vehicle has been driven since the meter was last reset.

Trip meters "A" and "B" can be used to record and display different distances independently.

### Changing the display

Switches between odometer and trip meter displays. When the trip meter is displayed, pressing and holding the button will reset the trip meter.

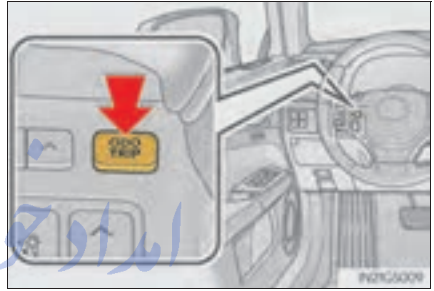

### Instrument panel light control

The brightness of the instrument panel lights can be adjusted.

- ① Darker
- ② Brighter

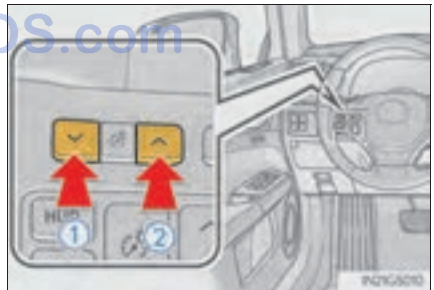

### ■ The meters and display illuminate when

The engine switch is in IGNITION ON mode.

### ■ Instrument panel brightness adjustment

The instrument panel brightness levels when the tail lights are on and off can be adjusted individually. However, when the surroundings are bright (daytime, etc.), turning on the tail lights will not change the instrument panel brightness. At this time, any adjustments made to the instrument panel brightness levels will be applied to both settings at once.

### ■ Limitation of brightness adjustment

The brightness of the instrument panel lights is automatically adjusted based on the light sensor detecting how bright the surroundings are. However, if the instrument panel brightness has been manually set to either the brightest or darkest setting, the automatic adjustment will not be performed.

### ■ ECO lamp and SPORT lamp

- When sport mode is selected, SPORT lamp (red) will illuminate.
- When all of the following conditions are satisfied and Eco-friendly driving, ECO lamp (blue) will illuminate. (ECO lamp will become brighter the more Eco-friendly driving you perform. Also, while the acceleration exceeds Zone of Eco driving, ECO lamp turns off. (→P. 88) However, when Eco drive mode is selected, while the acceleration exceeds Zone of Eco driving, ECO lamp does not turn off.):
  - Driving with the shift lever in D
  - Paddle shift switch is not operated.
  - Either normal mode or Eco drive mode is selected.
  - The vehicle speed is approximately 80 mph (130 km/h) or below.

### ■ Customization

Settings (e.g. on/off operation of ECO lamp) can be changed.  
(Customizable features →P. 777)

### NOTICE

#### ■ To prevent damage to the engine and its components

- Do not let the indicator needle of the tachometer enter the red zone, which indicates the maximum engine speed.
- The engine may be overheating if the engine coolant temperature gauge is in the red zone (H). In this case, immediately stop the vehicle in a safe place, and check the engine after it has cooled completely. (→P. 747)

## Multi-information display

### Display contents

The multi-information display presents the driver with a variety of driving-related data including the current outside air temperature.

- Eco Driving Indicator (→P. 88)

- Outside temperature display (→P. 83)

- Trip information (→P. 83)

Displays driving range, fuel consumption and other cruising related information



- Tire inflation pressure (if equipped) (→P. 639)

- Drive monitor (→P. 85)

- Intuitive parking assist display\* (if equipped) (→P. 240)

- Dynamic radar cruise control display\* (if equipped) (→P. 213)

- LKA (Lane-Keeping Assist) display\* (if equipped) (→P. 232)

- Warning messages (→P. 697)

Automatically displayed when a malfunction occurs in one of the vehicle's systems. Display can be switched by pressing the "DISP" button. (→P. 83)

\*: Automatically displayed when the system is used. Display can be switched by pressing the "DISP" button. (→P. 83)



## Trip information

### ■ Switching the display

Items displayed can be switched by pressing the “DISP” button.



### ■ Eco Driving Indicator

→P. 88

### ■ Outside temperature

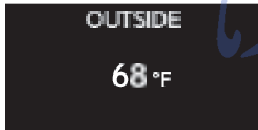

Displays the outside air temperature

The temperature range that can be displayed is from -40°F (-40°C) to 50°F (122°C)

تلفن شبانه روزی: ۰۲۱-۸۸۶۲۰۸۵

### ■ Current fuel consumption

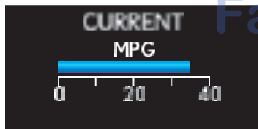

Displays the current rate of fuel consumption

### ■ Average fuel consumption after refueling



Displays the average fuel consumption since the vehicle was last refueled

Use the displayed average fuel consumption as a reference.

### ■ Average fuel consumption

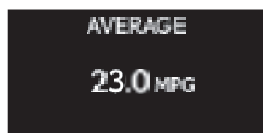

Displays the average fuel consumption since the function was reset

- The function can be reset by pressing the “DISP” button for longer than 1 second when the average fuel consumption is displayed.
- Use the displayed average fuel consumption as a reference.

### ■ Average vehicle speed

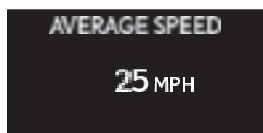

Displays the average vehicle speed since the engine was last started.

- The function can be reset by pressing the “DISP” button for longer than 1 second when the average vehicle speed is displayed.

### ■ Driving range

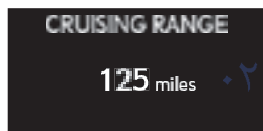

Displays the estimated maximum distance that can be driven with the quantity of fuel remaining

- This distance is computed based on your average fuel consumption. As a result, the actual distance that can be driven may differ from that displayed.
  - When only a small amount of fuel is added to the tank, the display may not be updated.
- When refueling, turn the engine switch off. If the vehicle is refueled without turning the engine switch off, the display may not be updated.

امداد خودرو فارما

تلفن: ۰۲۱-۸۸۶۳۰۸۵

Farmasos.com

## ■ Tire inflation pressure (if equipped)



Displays inflation pressure of each tire.

The inflation pressure of the spare tire will not be displayed.

## Drive monitor

Outside temperature, average fuel consumption after refueling or driving range can be selected and displayed.

If displayed on the drive monitor, other trip information or warning messages can be displayed simultaneously.

For display and selection procedures, follow the “Setting up the displays”.

The information displayed on the drive monitor will not be displayed on the trip information screen.



## Setting up the displays

- 1 While the vehicle is stopped, press the “DISP” button until the “Settings” screen appears.

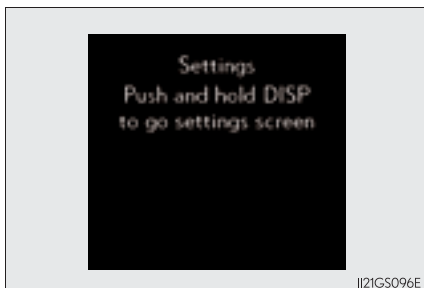

- 2 Press and hold the “DISP” button until the screen changes.



- 3 Press and hold the “DISP” button after selecting the desired setting item by pressing the “DISP” button.

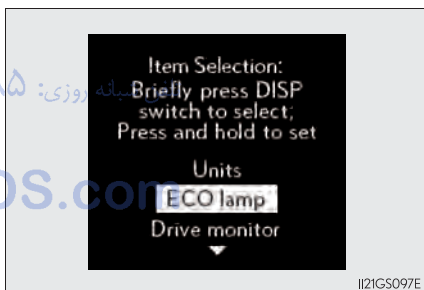

- 4** Press and hold the “DISP” button after selecting the desired setting by pressing the “DISP” button.

The display goes back to step **3**.

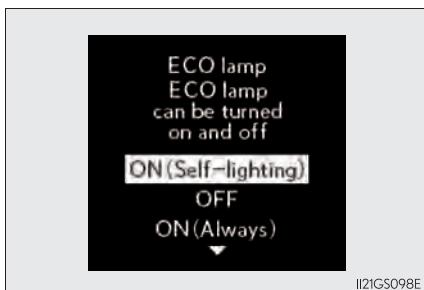

- 5** Press and hold the “DISP” button after selecting the “EXIT” by pressing the “DISP” button.

The display goes back to step **1**.

(The display goes back to step **1** automatically in few seconds without proceeding step **5**.)

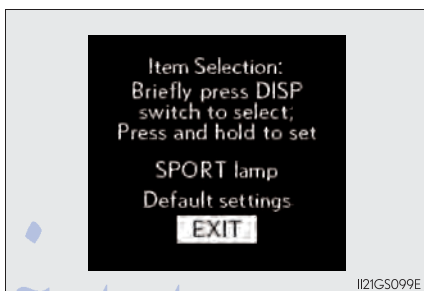

امداد خودرو فارما

تلفن شبانه روزی: ۰۲۱-۸۸۶۲۰۸۵

FarmaSOS.com

### ■ System check display

After turning the engine switch to IGNITION ON mode, "SYSTEM CHECK" is displayed while system operation is checked.

### ■ Eco Driving Indicator Zone Display

Suggests Zone of Eco driving and Eco driving ratio based on acceleration.

#### ① Eco driving ratio based on acceleration

If the acceleration exceeds Zone of Eco driving, the right side of Eco Driving Indicator Zone Display blinks.

#### ② Zone of Eco driving

Eco Driving Indicator will not operate in the following conditions:

- The shift lever is anything other than D.
- Paddle shift switch is operated.
- Neither normal mode nor Eco drive mode is selected. (→P.179)
- The vehicle speed is approximately 80 mph (130 km/h) or higher.

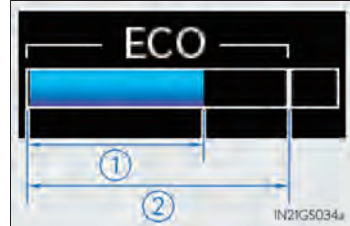

### ■ Outside temperature display

In the following situations, the correct outside temperature may not be displayed, or the display may take longer than normal to change, تلفن شبانه

- When stopped, or driving at low speeds (less than 12 mph [20 km/h])
- When the outside temperature has changed suddenly (at the entrance/exit of a garage, tunnel, etc.)

### ■ Setting display automatic cancelation

In the following situations, setting display in which the settings can be changed through the "DISP" button will automatically be turned off.

- When a warning message appears while the setting display is displayed
- When the vehicle begins to move while the setting display is displayed

### ■ Tire inflation pressure (if equipped)

- It may take a few minutes to display the tire inflation pressure after the engine switch is turned to IGNITION ON mode. It may also take a few minutes to display the tire inflation pressure after inflation pressure has been adjusted.
- “---” may be displayed if the tire information cannot be determined due to unfavorable radio wave conditions.
- Tire inflation pressure changes with temperature. The displayed values may also be different from the values measured using a tire pressure gauge.

### ■ Liquid crystal display

Small spots or light spots may appear on the display. This phenomenon is characteristic of liquid crystal displays, and there is no problem continuing to use the display.

### ■ Customization

Setting of available languages can be changed. (Customizable features →P. 777)



### CAUTION

#### ■ The information display at low temperatures

Allow the interior of the vehicle to warm up before using the liquid crystal information display. At extremely low temperatures, the information display monitor may respond slowly, and display changes may be delayed.

For example, there is a lag between the driver's shifting and the new gear number appearing on the display. This lag could cause the driver to downshift again, causing rapid and excessive engine braking and possibly an accident resulting in death or injury.

#### ■ Cautions during setting up the display

As the engine needs to be running during setting up the display, ensure that the vehicle is parked in a place with adequate ventilation. In a closed area such as a garage, exhaust gases including harmful carbon monoxide (CO) may collect and enter the vehicle. This may lead to death or a serious health hazard.



### NOTICE

#### ■ During setting up the display

To prevent battery discharge, ensure that the engine is running while setting up the display features.

## Head-up display\*

### Summary of functions

The head-up display can be used to project vehicle speed and other information onto the windshield.

#### ① Head-up display

Display brightness will change automatically according to the brightness of the surrounding area.

#### ② “HUD” button

#### ③ Display position adjustment switch

#### ④ Display brightness adjustment switch

Display brightness can be adjusted to the desired level.

#### ⑤ “DISP” button

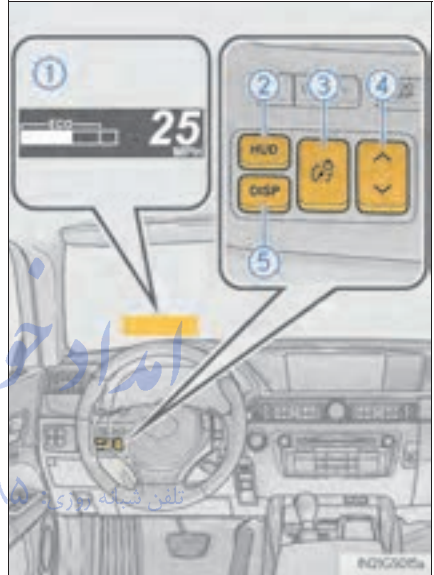

FarmaSOS.com



## Head-up display contents

- Vehicle speed
- Tachometer
- Shift position and shift range
  - Displays the selected shift position or selected shift range (→P.178)
- Eco Driving Indicator (→P. 83)
- Audio display
  - Displays audio information for approximately 3 seconds when the audio system is operated
- Route guidance display (vehicles with navigation system) (→P. 94)
  - When approaching an intersection while the navigation system is giving route guidance, an arrow will automatically be displayed to indicate the direction of travel.
- Lane departure warning display (LKA [Lane-Keeping Assist]) (if equipped) (→P. 709)
- Approach warning display (dynamic radar cruise control) (if equipped) (→P. 708)
- Pre-collision braking warning message (pre-collision system) (if equipped) (→P. 699)

## Switching the head-up display

### ■ “HUD” button

Pressing the switch turns the head-up display on/off and changes the vehicle speed display units as follows:

#### ► U.S.A.

OFF → ON (MPH) →

ON (km/h) → OFF

#### ► Canada

OFF → ON (km/h) →

ON (MPH) → OFF



### ■ “DISP” button

Pressing the button changes the display items (except vehicle speed).

- ① Off
- ② Eco Driving Indicator
- ③ Tachometer

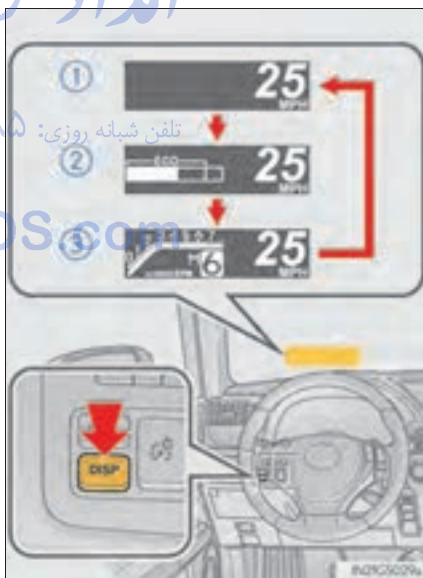

## Making the display easier to see

### ■ Adjusting the display position

- ① Higher
- ② Lower

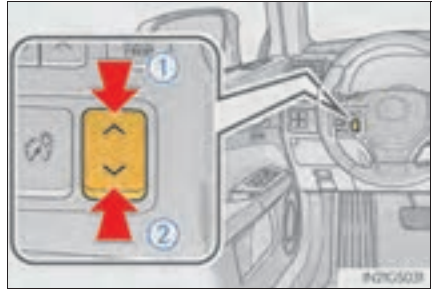

### ■ Setting the brightness

The brightness of the display is automatically adjusted in accordance with the brightness of the surrounding environment. However, the brightness can also be manually adjusted in 9 stages.

- ① Brighter
- ② Darker

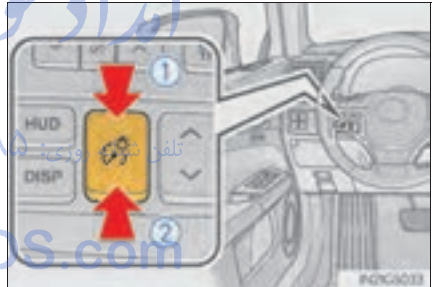

## Route guidance display (vehicles with navigation system)

When the vehicle approaches an intersection, the direction the vehicle should go is guided by the arrow. When the vehicle approaches an intersection, the route guidance will start and the distance\* to the intersection will also be displayed.

The distance decreases in increments of 164 ft. (50 m) and the distance indication will disappear when the vehicle passes through the intersection.



## Display customization

The following display can be shown or hidden.

- ① Audio display
- ② Route guidance display (vehicles with navigation system)

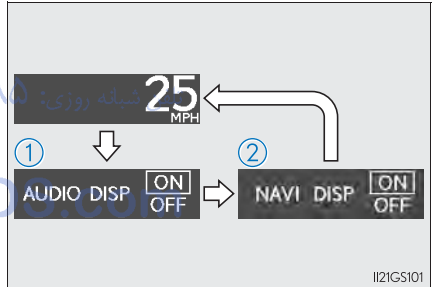

## ■ Customizing the display

- 1 Press and hold the “DISP” button until the screen changes, then press and hold repeatedly until the item you wish to change is displayed.

Customization can be performed when the head-up display is on and the vehicle is traveling at less than 5 mph (8 km/h).

- 2 Press the “DISP” button to switch between on and off.

On and off will be switched between each time the button is pressed.

If the button is left alone without being operated for a short time, setting will be finished automatically.

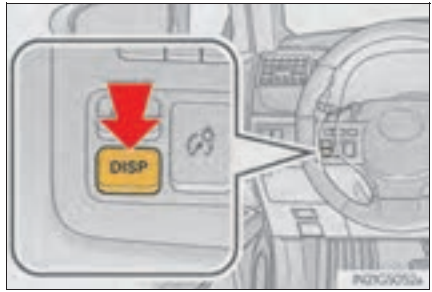

امداد خودرو فارما

تلفن شبانه روزی: +۸۵ ۰۸۸۶۲-۰۲۱

FarmaSOS.com

### ■ Head-up display

- The head-up display may seem dark and hard to see when viewed through sunglasses, especially polarized sunglasses.  
Adjust the brightness of the head-up display or remove your sunglasses.
- When the head-up display is turned off, it will remain off even if the engine switch is turned to IGNITION ON mode after the engine switch has been turned off.

### ■ When the battery is disconnected

The customize settings of the head-up display will be reset.

## ⚠ CAUTION

### ■ Before using the head-up display

Check that the position and brightness of the head-up display image does not interfere with safe driving. Incorrect adjustment of the image's position or brightness may obstruct the driver's view and lead to an accident, resulting in death or serious injury.

## ⚠ NOTICE

### ■ To prevent damage to components

- Do not place any drinks near the head-up display projector. If the projector gets wet, electrical malfunctions may result.
- Do not place anything on or put stickers onto the head-up display projector. Doing so could interrupt head-up display indications.
- Do not touch the inside of the head-up display projector or thrust sharp edges or the like into the projector. Doing so could cause mechanical malfunctions.

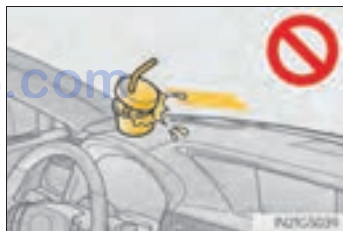

<b>3-1. Key information</b>	
Keys .....	98
<b>3-2. Opening, closing and locking the doors and trunk</b>	
Smart access system with push-button start .....	101
Wireless remote control .....	114
Doors .....	117
Trunk.....	121
<b>3-3. Adjusting the seats</b>	
Front seats.....	128
Driving position memory.....	130
Head restraints .....	136
<b>3-4. Adjusting the steering wheel and mirrors</b>	
Steering wheel .....	139
Inside rear view mirror.....	140
Outside rear view mirrors.....	142
<b>3-5. Opening, closing the windows and moon roof</b>	
Power windows .....	145
Moon roof.....	148

## Keys

### The keys

The following keys are provided with the vehicle.

- ① Electronic keys
  - Operating the smart access system with push-button start (→P. 101)
  - Operating the wireless remote control function (→P. 114)
- ② Mechanical keys
- ③ Key number plate

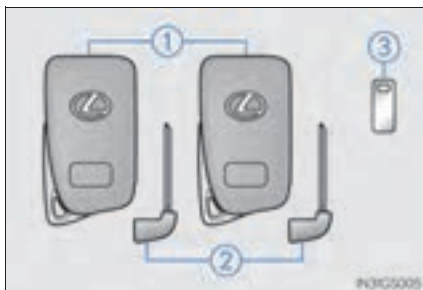

### Using the mechanical key

To take out the mechanical key, push the release button and take the key out.

The mechanical key can only be inserted in one direction, as the key only has grooves on one side. If the key cannot be inserted in a lock cylinder, turn it over and re-attempt to insert it.

After using the mechanical key, store it in the electronic key. Carry the mechanical key together with the electronic key. If the electronic key battery is depleted or the entry function does not operate properly, you will need the mechanical key.

(→P. 740)

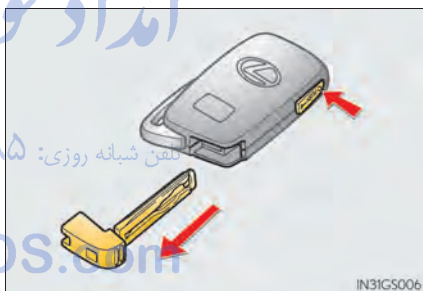



**■ When required to leave the vehicle's key with a parking attendant**

Turn the trunk opener main switch off, lock the glove box and armrest door as circumstances demand. (→P. 122, 553, 575)

Remove the mechanical key for your own use and provide the attendant with the electronic key only.

**■ If you lose your mechanical keys**

New genuine mechanical keys can be made by your Lexus dealer using the other mechanical key and the key number stamped on your key number plate. Keep the plate in a safe place such as your wallet, not in the vehicle.

**■ When riding in an aircraft**

When bringing an electronic key onto an aircraft, make sure you do not press any buttons on the electronic key while inside the aircraft cabin. If you are carrying an electronic key in your bag etc., ensure that the buttons are not likely to be pressed accidentally. Pressing a button may cause the electronic key to emit radio waves that could interfere with the operation of the aircraft.

امداد خودرو فارما

تلفن شبانه روزی: ۰۲۱-۸۸۶۲۰۸۵

FarmaSOS.com

 NOTICE**■ To prevent key damage**

- Do not drop the keys, subject them to strong shocks or bend them.
- Do not expose the keys to high temperatures for long periods of time.
- Do not get the keys wet or wash them in an ultrasonic washer etc.
- Do not attach metallic or magnetic materials to the keys or place the keys close to such materials.
- Do not disassemble the keys.
- Do not attach a sticker or anything else to the surface of the electronic key.
- Do not place the keys near objects that produce magnetic fields, such as TVs, audio systems and glass top ranges, or medical electrical equipment, such as low-frequency therapy equipment.

**■ Carrying the electronic key on your person**

Carry the electronic key 3.9 in. (10 cm) or more away from electric appliances that are turned on. Radio waves emitted from electric appliances within 3.9 in. (10 cm) of the electronic key may interfere with the key, causing the key to not function properly.

**■ In case of a smart access system with push-button start malfunction or other key-related problems**

Take your vehicle with all the electronic keys provided with your vehicle to your Lexus dealer.

**■ When an electronic key is lost**

If the electronic key remains lost, the risk of vehicle theft increases significantly. Visit your Lexus dealer immediately with all remaining electronic keys that was provided with your vehicle.

## Smart access system with push-button start

### Function summary

The following operations can be performed simply by carrying the electronic key on your person, for example in your pocket. (The driver should always carry the electronic key.)

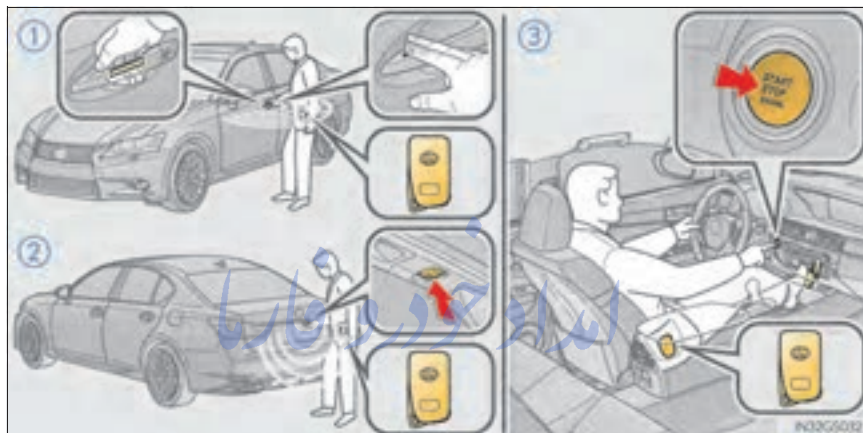

- ① Locks and unlocks the doors (→P. 102) تلفن شبانه روزی: ۰۲۱-۸۸۹۳۰۰۰۰
- ② Opens the trunk (→P. 102)
- ③ Starts the engine (→P. 171)

#### ■ Operation signals

A buzzer sounds and the emergency flashers flash to indicate that the doors have been locked/unlocked. (Locked: once; Unlocked: twice)

#### ■ Security feature

If a door is not opened within approximately 60 seconds after the vehicle is unlocked, the security feature automatically locks the vehicle again.

#### ■ Welcome light illumination control

The side marker, parking, tail and license plate lights automatically turn on at night when the doors are unlocked using the entry function or wireless remote control if the light switch is in the "AUTO" position.

## Unlocking and locking the doors

Grip the driver's door handle to unlock the door. Grip the passenger's door handle to unlock all the doors.\*

Make sure to touch the sensor on the back of the handle.

The doors cannot be unlocked for 3 seconds after the doors are locked.

\*: The door unlock settings can be changed. (→P. 106)

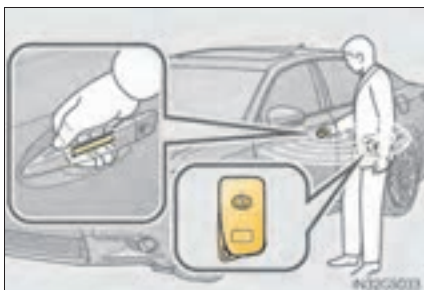

Touch the lock sensor (the indentation on the upper part of the door handle) to lock all the doors.



## Opening the trunk

Press the button.

If the vehicle is equipped with power trunk opener and closer, the trunk lid automatically opens fully.

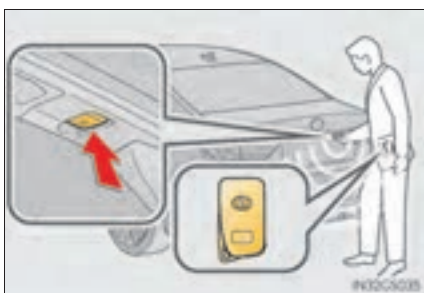

## Antenna location and effective range

### ■ Antenna location

- ① Antennas outside the cabin
- ② Antennas inside the cabin
- ③ Antenna outside the trunk
- ④ Antenna inside the trunk

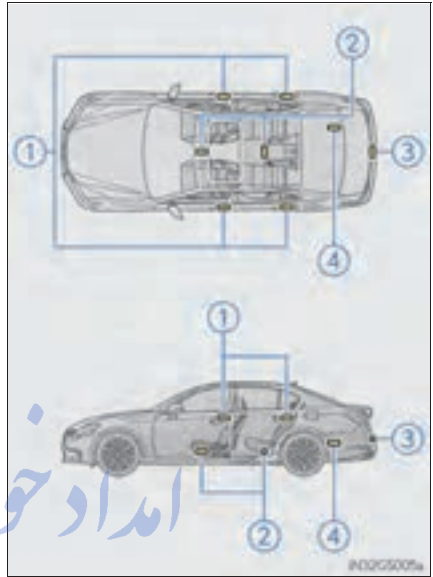

تلفن شبانه روزی: ۰۲۱-۸۸۶۲۰۸۵

FarmaSOS.com

### ■ Effective range (areas within which the electronic key is detected)

- When locking or unlocking the doors

The system can be operated when the electronic key is within about 2.3 ft. (0.7 m) of an outside door handle. (Only the doors detecting the key can be operated.)

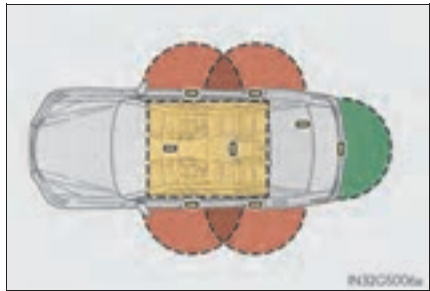

- When opening the trunk

The system can be operated when the electronic key is within about 2.3 ft. (0.7 m) of the trunk release button.

- When starting the engine or changing engine switch modes

The system can be operated when the electronic key is inside the vehicle.

تلفن شبانه روزی: ۰۲۱-۸۸۶۲۰۸۵

- When the door cannot be locked by the lock sensor on the upper part of the door handle

If the door will not lock even when the topside sensor area is touched, try touching both the topside and underside sensor areas at the same time.



### ■ Alarms and warning indicators





An alarm sounds and warning message displays shown on the multi-information display are used to protect against unexpected accidents or theft of the vehicle resulting from erroneous operation. When a warning message is displayed, take appropriate measures based on the displayed message. (→P. 697)

When only an alarm sounds, circumstances and correction procedures are as follows.



Alarm	Situation	Correction procedure
Exterior alarm sounds once for 5 seconds	The trunk was closed while the electronic key was still inside the trunk and all the doors were locked.	Retrieve the electronic key from the trunk and close the trunk lid.
	An attempt was made to lock the vehicle while a door was open.	Close all of the doors and lock the doors again.
Interior alarm sounds continuously	The engine switch was turned to ACCESSORY mode while the driver's door was open (or the driver's door was opened while the engine switch was in ACCESSORY mode).	Turn the engine switch off and close the driver's door.

### ■ Switching the door unlock function

It is possible to set which doors the entry function unlocks using the wireless remote control.

- 1 Turn the engine switch off.
- 2 When the indicator light on the key surface is not on, press and hold  ,  or  for approximately 5 seconds while pressing and holding .

The setting changes each time an operation is performed, as shown below. (When changing the setting continuously, release the buttons, wait for at least 5 seconds, and repeat step 2.)

Multi-information display	Unlocking function	Beep
	Holding the driver's door handle unlocks only the driver's door.	Exterior: Beeps 3 times Interior: Pings once
	Holding a passenger's door handle unlocks all the doors.	
	Holding a door handle unlocks all the doors.	Exterior: Beeps twice Interior: Pings once

To prevent unintended triggering of the alarm, unlock the doors using the wireless remote control and open and close a door once after the settings have been changed. (If a door is not opened within 60 seconds after  is pressed, the doors will be locked again and the alarm will automatically be set.)

In case that the alarm is triggered, immediately stop the alarm. (→P. 70)





### ■ Battery-saving function

The battery-saving function will be activated in order to prevent the electronic key battery and the vehicle battery from being discharged while the vehicle is not in operation for a long time.

- In the following situations, the smart access system with push-button start may take some time to unlock the doors.
  - The electronic key has been left in an area of approximately 6 ft. (2 m) of the outside of the vehicle for 10 minutes or longer.
  - The smart access system with push-button start has not been used for 5 days or longer.
- If the smart access system with push-button start has not been used for 14 days or longer, the doors cannot be unlocked at any doors except the driver's door. In this case, take hold of the driver's door handle, or use the wireless remote control or the mechanical key, to unlock the doors.

### ■ Electronic Key Battery-Saving Function

When battery-saving mode is set, battery depletion is minimized by stopping the electronic key from receiving radio waves.

Press  twice while pressing and holding . Confirm that the electronic key indicator flashes 4 times.

While the battery-saving mode is set, the smart access system with push-button start cannot be used. To cancel the function, press any of the electronic key buttons.



### ■ Conditions affecting operation

The smart access system with push-button start uses weak radio waves. In the following situations, the communication between the electronic key and the vehicle may be affected, preventing the smart access system with push-button start, wireless remote control and engine immobilizer system from operating properly. (Ways of coping: →P. 740)

- When the electronic key battery is depleted
- Near a TV tower, electric power plant, gas station, radio station, large display, airport or other facility that generates strong radio waves or electrical noise
- When carrying a portable radio, cellular phone, cordless phone or other wireless communication device
- When the electronic key is in contact with, or is covered by the following metallic objects
  - Cards to which aluminum foil is attached
  - Cigarette boxes that have aluminum foil inside
  - Metallic wallets or bags
  - Coins
  - Hand warmers made of metal
  - Media such as CDs and DVDs
- When other wireless keys (that emit radio waves) are being used nearby
- When carrying the electronic key together with the following devices that emit radio waves
  - Another vehicle's electronic key or a wireless key that emits radio waves
  - Personal computers or personal digital assistants (PDAs)
  - Digital audio players
  - Portable game systems
- If window tint with a metallic content or metallic objects are attached to the rear window

**■ Note for the entry function**

- Even when the electronic key is within the effective range (detection areas), the system may not operate properly in the following cases:
  - The electronic key is too close to the window or outside door handle, near the ground, or in a high place when the doors are locked or unlocked.
  - The electronic key is near the ground or in a high place, or too close to the rear bumper center when the trunk is opened.
  - The electronic key is on the instrument panel, rear package tray or floor, or in the door pockets or glove box when the engine is started or engine switch modes are changed.
- Do not leave the electronic key on top of the instrument panel or near the door pockets when exiting the vehicle. Depending on the radio wave reception conditions, it may be detected by the antenna outside the cabin and the door will become lockable from the outside, possibly trapping the electronic key inside the vehicle.
- As long as the electronic key is within the effective range, the doors may be locked or unlocked by anyone. However, only the doors detecting the electronic key can be used to unlock the vehicle.
- Even if the electronic key is not inside the vehicle, it may be possible to start the engine if the electronic key is near the window.
- The doors may unlock or lock if a large amount of water splashes on the door handle, such as in the rain or in a car wash when the electronic key is within the effective range. (The doors will automatically be locked after approximately 60 seconds if the doors are not opened and closed.)
- If the wireless remote control is used to lock the doors when the electronic key is near the vehicle, there is a possibility that the door may not be unlocked by the entry function. (Use the wireless remote control to unlock the doors.)

**■ Note for locking the doors**

- Touching the door lock sensor while wearing gloves may delay or prevent lock operation. Remove the gloves and touch the lock sensor again.
- If the door handle becomes wet while the electronic key is within the effective range, the door may lock and unlock repeatedly. In that case, follow the following correction procedures to wash the vehicle:
  - Place the electronic key in a location 6 ft. (2 m) or more away from the vehicle. (Take care to ensure that the key is not stolen.)
  - Set the electronic key to battery-saving mode to disable the smart access system with push-button start. (→P. 107)
- If the electronic key is inside the vehicle and a door handle becomes wet during a car wash, a message may be shown on the multi-information display and a buzzer will sound outside the vehicle. To turn off the alarm, lock all the doors.
- The lock sensor may not work properly if it comes into contact with ice, snow, mud, etc. Clean the lock sensor and attempt to operate it again, or use the lock sensor on the lower part of the door handle.
- Fingernails may scrape against the door during operation of the door handle. Be careful not to injure fingernails or damage the surface of the door.

**■ Note for the unlocking function**

- A sudden approach to the effective range or door handle may prevent the doors from being unlocked. In this case, return the door handle to the original position and check that the doors unlock before pulling the door handle again.
- Gripping the door handle when wearing a glove may not unlock the door.
- If the door handle becomes wet while the electronic key is within the effective range, the door may lock and unlock repeatedly. In that case, follow the following correction procedures to wash the vehicle:
  - Place the electronic key in a location 6 ft. (2 m) or more away from the vehicle. (Take care to ensure that the key is not stolen.)
  - Set the electronic key to battery-saving mode to disable the smart access system with push-button start. (→P. 107)
- If there is another electronic key in the detection area, it may take slightly longer to unlock the doors after the door handle is gripped.
- Fingernails may scrape against the door during operation of the door handle. Be careful not to injure fingernails or damage the surface of the door.

### ■ When the vehicle is not driven for extended periods

- To prevent theft of the vehicle, do not leave the electronic key within 6 ft. (2 m) of the vehicle.
- The smart access system with push-button start can be deactivated in advance. (→P. 777)

### ■ Alarm

Using the smart access system with push-button start to lock the doors will set the alarm system. (→P. 70)

### ■ To operate the system properly

- Make sure to carry the electronic key when operating the system. Do not get the electronic key too close to the vehicle when operating the system from the outside of the vehicle.

Depending on the position and holding condition of the electronic key, the key may not be detected correctly and the system may not operate properly. (The alarm may go off accidentally, or the door lock prevention function may not operate.)

- Do not leave the electronic key inside the luggage compartment. The key confinement prevention function may not operate, depending on the location of the key (close to a spare tire, the inside edge of the luggage compartment), conditions (inside a metal bag, close to metallic objects) and the radio waves in the surrounding area. (→P. 123)

### ■ If the smart access system with push-button start does not operate properly

- Locking and unlocking the doors and opening the trunk: Use the mechanical key. (→P. 740)
- Starting the engine: →P. 741

### ■ Electronic key battery depletion

- The standard battery life is 1 to 2 years.
- If the battery becomes low, an alarm will sound in the cabin when the engine stops. (→P. 719)
- As the electronic key always receives radio waves, the battery will become depleted even if the electronic key is not used. The following symptoms indicate that the electronic key battery may be depleted. Replace the battery when necessary. (→P. 646)
  - The smart access system with push-button start or the wireless remote control does not operate.
  - The detection area becomes smaller.
  - The LED indicator on the key surface does not turn on.
- To avoid serious deterioration, do not leave the electronic key within 3 ft. (1 m) of the following electrical appliances that produce a magnetic field:
  - TVs
  - Personal computers
  - Cellular phones, cordless phones and battery chargers
  - Recharging cellular phones or cordless phones
  - Table lamps
  - Glass top ranges

### ■ When the electronic key battery is fully depleted

→P. 646

### ■ Customization

Settings (e. g. smart access system with push-button start) can be changed. (Customizable features: →P. 777)

### ■ If the smart access system with push-button start has been deactivated in a customized setting

- Locking and unlocking the doors and opening the trunk:  
Use the wireless remote control or mechanical key. (→P. 114, 740)
- Starting the engine and changing engine switch modes: →P. 741
- Stopping the engine: →P. 172

### ■ Certification for the smart access system with push-button start

- ▶ For vehicles sold in the U.S.A.

FCC ID: HYQ23AAB    FCC ID: HYQ14FBA

FCC ID: HYQ14CBA

FCC ID: NI4TMLF10-2

#### NOTE:

This device complies with part 15 of the FCC Rules. Operation is subject to the following two conditions: (1) This device may not cause harmful interference, and (2) this device must accept any interference received, including interference that may cause undesired operation.

#### FCC WARNING:

Changes or modifications not expressly approved by the party responsible for compliance could void the user's authority to operate the equipment.

- ▶ For vehicles sold in Canada

#### NOTE:

Operation is subject to the following two conditions: (1) this device may not cause interference, and (2) this device must accept any interference, including interference that may cause undesired operation of the device.

### CAUTION

#### ■ Caution regarding interference with electronic devices

- People with implanted pacemakers or cardiac defibrillators should keep away from the smart access system with push-button start antennas. (→P. 103)  
The radio waves may affect the operation of such devices. If necessary, the entry function can be disabled. Ask your Lexus dealer for details, such as the frequency of radio waves and timing of emitting the radio waves. Then, consult your doctor to see if you should disable the entry function.
- Users of any electrical medical device other than implanted pacemakers and implanted cardiac defibrillators should consult the manufacturer of the device for information about its operation under the influence of radio waves.  
Radio waves could have unexpected effects on the operation of such medical devices.

Ask your Lexus dealer for details on disabling the entry function.

## Wireless remote control

### Function summary

The wireless remote control can be used to lock and unlock the vehicle.

① Locks all the doors

② Unlocks all the doors

Pressing the button unlocks the driver's door. Pressing the button again within 5 seconds unlocks the other doors.

③ Opens the windows and moon roof (press and hold)\*

④ Opens the trunk (press and hold)

If the vehicle is equipped with a power trunk opener and closer, the trunk lid automatically opens fully.

⑤ Sounds the alarm (press and hold) (→P.115)

\*: This setting must be customized at your Lexus dealer.

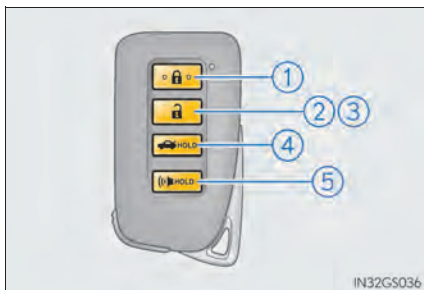

امداد خودرو فارما  
تلفن شبانه روزی: ۰۸۵ ۸۸۶۲ ۰۸۵  
FarmaSOS.com



### ■ Operation signals

Doors:

A buzzer sounds and the emergency flashers flash to indicate that the doors have been locked/unlocked. (Locked: once; Unlocked: twice)

Trunk:

A buzzer sounds to indicate that the trunk has been opened.

Windows and moon roof:

A buzzer sounds to indicate that the windows and moon roof are operating.

### ■ Welcome light illumination control

→P. 101

### ■ Door lock buzzer

If an attempt to lock the doors is made when a door is not fully closed, a buzzer sounds continuously for 5 seconds. Fully close the door to stop the buzzer, and lock the vehicle once more.

### ■ Panic mode

When  is pressed for longer than about one second, an alarm will sound intermittently and the vehicle lights will flash to deter any person from trying to break into or damage your vehicle.

To stop the alarm, press any button on the electronic key.



### ■ Security feature

→P. 101

### ■ Alarm

Using the wireless remote control to lock the doors will set the alarm system. (→P. 70)

### ■ Conditions affecting operation

→P. 108

**■ If the wireless remote control does not operate properly**

Locking and unlocking the doors and opening the trunk: Use the mechanical key. (→P. 740)

**■ Electronic key battery depletion**

→P. 112

**■ When the electronic key battery is fully depleted**

→P. 646

**■ Confirmation of the registered key number**

The number of keys already registered to the vehicle can be confirmed. Ask your Lexus dealer for details.

**■ Customization**

Settings (e.g. wireless remote control system) can be changed. (Customizable features: →P. 777)

**■ Certification for wireless remote control**

▶ For vehicles sold in the U.S.A.

FCC ID: HYQ23AAB    FCC ID: HYQ14FBA

FCC ID: HYQ14CBA

FCC ID: NI4TMLF10-2

NOTE:

This device complies with part 15 of the FCC Rules. Operation is subject to the following two conditions: (1) This device may not cause harmful interference, and (2) this device must accept any interference received, including interference that may cause undesired operation.

FCC WARNING:

Changes or modifications not expressly approved by the party responsible for compliance could void the user's authority to operate the equipment.

▶ For vehicles sold in Canada

NOTE:

Operation is subject to the following two conditions: (1) this device may not cause interference, and (2) this device must accept any interference, including interference that may cause undesired operation of the device.

## Doors

### Unlocking and locking the doors

The vehicle can be locked and unlocked using the entry function, wireless remote control or door lock switches.

#### ◆ Entry function

→P.101

#### ◆ Wireless remote control

→P.114

#### ◆ Door lock switches

- ① Locks all the doors
- ② Unlocks all the doors

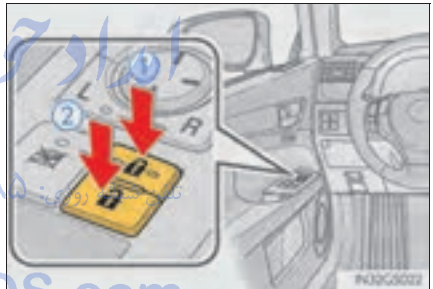

#### ◆ Inside lock buttons

- ① Locks the door
- ② Unlocks the door

The front doors can be opened by pulling the inside handle even if the lock buttons are in the lock position.

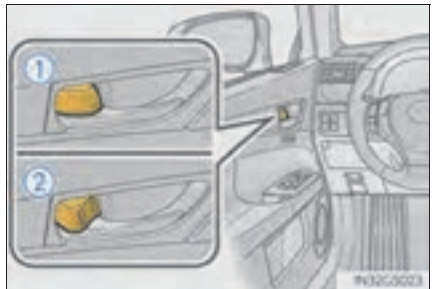

### Locking the front doors from the outside without a key

- 1 Move the inside lock button to the lock position.
- 2 Close the door.

The door cannot be locked if the engine switch is in ACCESSORY or IGNITION ON mode, or the electronic key is left inside the vehicle.

The key may not be detected correctly and the door may be locked.

### Rear door child-protector lock

The door cannot be opened from inside the vehicle when the lock is set.

- 1 Unlock
- 2 Lock

These locks can be set to prevent children from opening the rear doors. Push down on each rear door switch to lock both rear doors.



## Automatic door locking and unlocking systems

The following functions can be set or canceled:

For instructions on customizing, refer to P. 777.

Function	Operation
"Auto Lock by Speed"	All doors are automatically locked when vehicle speed is approximately 12 mph (20 km/h) or higher.
"Auto Lock by Shift from P"	All doors are automatically locked when shifting the shift lever to position other than P.
"Auto Unlock by Shift to P"	All doors are automatically unlocked when shifting the shift lever to P.
"Auto Unlock by Driver Door"	All doors are automatically unlocked when driver's door is opened.

### ■ Impact detection door lock release system

In the event that the vehicle is subject to a strong impact, all the doors are unlocked. Depending on the force of the impact or the type of accident, however, the system may not operate.

### ■ Using the mechanical key

The doors can also be locked and unlocked with the mechanical key. (→P. 740)

### ■ If a wrong key is used

The key cylinder rotates freely to isolate inside mechanism.

### ■ Customization

Settings (e.g. unlocking function using a key) can be changed.  
(Customizable features: →P. 777)

 CAUTION**■ To prevent an accident**

Observe the following precautions while driving the vehicle.

Failure to do so may result in a door opening and an occupant throwing out of the vehicle, resulting in death or serious injury.

- Ensure that all doors are properly closed and locked.
- Do not pull the inside handle of the doors while driving.  
Be especially careful for the front doors, as the doors may be opened even if the inside lock buttons are in locked position.
- Set the rear door child-protector locks when children are seated in the rear seats.

امداد خودرو فارما

تلفن شبانه روزی: ۰۲۱-۸۸۸۶۲۰۸۵

FarmaSOS.com

## Trunk

The trunk can be opened using the trunk opener, entry function or wireless remote control.

If the vehicle is equipped with a power trunk opener and closer, the trunk can be closed using the trunk closer.

### Opening the trunk from inside the vehicle

Press the opener switch.

If the vehicle is equipped with a power trunk opener and closer, the trunk lid automatically opens fully.

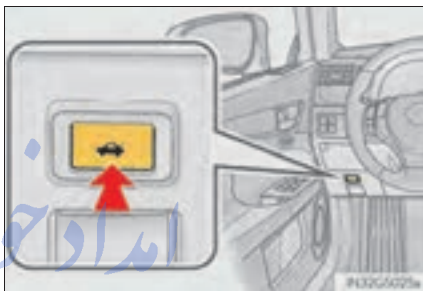

### Opening the trunk from outside the vehicle

#### ■ Entry function

→P.101

#### ■ Wireless remote control

→P.114

امداد خودرو فارما

تلفن شبانه روزی: ۰۲۱-۸۸۸۱۰۸۸

FarmaSOS.com

### Trunk closer switch (vehicles with power trunk opener and closer)

Pressing the switch closes the trunk lid automatically. (A buzzer sounds.)

Pressing the switch while the trunk lid is closing opens the trunk lid again.



### Luggage security system

The trunk opener switch can be temporarily disabled to protect luggage stored in the trunk against theft.

Turn the main switch in the glove box off to disable the trunk opener.

- ① On
- ② Off

The trunk lid cannot be opened even with the wireless remote control or the entry function.



FarmaSOS.com

#### ■ Trunk light

The trunk light turns on when the trunk is opened.

#### ■ Trunk handle

Use the trunk handle when closing the trunk.





**■ Trunk easy closer (vehicles with power trunk opener and closer)**

In the event that the trunk lid is left slightly open, the trunk easy closer will automatically close it to the fully closed position.

**■ Function to prevent the trunk being locked with the electronic key inside**

● When all doors are being locked, closing the trunk lid with the electronic key left inside the trunk will sound an alarm.

In this case, the trunk lid can be opened pressing the trunk release button on the trunk lid.

● Even when the spare electronic key is put in the trunk with all the doors locked, the key confinement prevention function can be activated so the trunk can be opened. In order to prevent theft, take all electronic keys with you when leaving the vehicle.

● Even when the electronic key is put in the trunk with all the doors are locked, the key may not be detected depending on the places and the surrounding radio wave conditions. In this case, the key confinement prevention function cannot be activated, causing the doors to lock when the trunk is closed. Make sure to check where the key is before closing the trunk.

● The key confinement prevention function cannot be activated if any one of the doors is unlocked. In this case, open the trunk using the trunk opener.

**■ Overload protection function (vehicles with power trunk opener and closer)**

The trunk lid will not operate when excessive load is present on the top of the trunk lid.

**■ Fall-down protection function (vehicles with power trunk opener and closer)**

While the trunk lid is opening automatically, applying excessive force to it will stop the opening operation to prevent the trunk lid from rapidly falling down.

**■ Jam protection function (vehicles with power trunk opener and closer)**

While the trunk lid is closing automatically, the trunk lid will stop closing and open if something gets caught.

### ■ Internal trunk release lever

The trunk lid can be opened by pulling the glow-in-the-dark lever located on the inside of the trunk lid to the side.

The lever will continue to glow for some time after the trunk lid is closed.

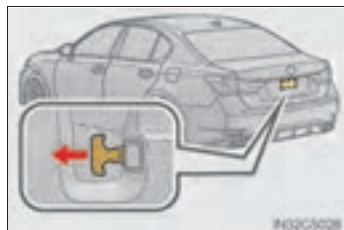

### ■ Using the mechanical key

The trunk can be also opened using the mechanical key. (→P. 741)

### ■ When leaving a key to the vehicle with a parking attendant

→P. 99

## ⚠ CAUTION

Observe the following precautions.

Failure to do so may result in death or serious injury.

### ■ Before driving

- Make sure that the trunk lid is fully closed. If the trunk lid is not fully closed, it may open unexpectedly while driving and hit near-by objects or luggage in the trunk may be thrown out, causing an accident.
- Do not allow children to enter the trunk.  
If a child is accidentally locked in the trunk, they could overheat or suffocate.
- Do not allow a child to open or close the trunk lid.  
Doing so may cause the trunk lid to open unexpectedly, or cause the child's hands, head, or neck to be caught by the closing trunk lid.

### ■ Important points while driving

Never let anyone sit in the trunk. In the event of sudden braking or a collision, they are susceptible to death or serious injury.

## ⚠ CAUTION

### ■ Using the trunk

Observe the following precautions.

Failure to do so may cause parts of the body to be caught, resulting in serious injury.

- Remove any heavy loads, such as snow and ice, from the trunk lid before opening it. Failure to do so may cause the trunk lid to fall closed again after it is opened.
- When opening or closing the trunk lid, thoroughly check to make sure the surrounding area is safe.
- If anyone is in the vicinity, make sure they are safe and let them know that the trunk is about to open or close.
- Use caution when opening or closing the trunk lid in windy weather as it may move abruptly in strong wind.
- The trunk lid may fall if it is not opened fully. It is more difficult to open or close the trunk lid on an incline than on a level surface, so beware of the trunk lid unexpectedly opening or closing by itself. Make sure that the trunk lid is fully open and secure before using the trunk.
- When closing the trunk lid, take extra care to prevent your fingers etc. from being caught.
- When closing the trunk lid, make sure to press it lightly on its outer surface. If the trunk handle is used to fully close the trunk lid, it may result in hands or arms being caught.
- Do not attach any accessories other than genuine Lexus parts to the trunk lid. Such additional weight on the trunk lid may cause the lid to fall closed again after it is opened.



## ⚠ CAUTION

### ■ Trunk easy closer (vehicles with power trunk opener and closer)

In the event that the trunk lid is left slightly open, the trunk easy closer will automatically close it to the fully closed position. It takes several seconds before the trunk easy closer begins to operate. Be careful not to catch fingers or anything else in the trunk lid, as this may cause bone fractures or other serious injuries.

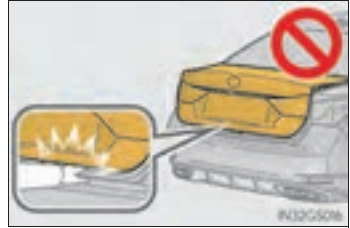

### ■ Power trunk opener and closer (if equipped)

Observe the following precautions when operating the power trunk opener and closer.

Failure to do so may cause serious injury.

- Check the safety of the surrounding area to make sure there are no obstacles or anything that could cause any of your belongings to get caught.
- If anyone is in the vicinity, make sure they are safe and let them know that the trunk is about to open or close.
- If the trunk closer switch is pressed while the trunk lid is opening during automatic operation, the trunk lid stops opening. Take extra care when on an incline, as the trunk lid may open or close suddenly.
- On an incline, the trunk lid may fall after it opens automatically. Make sure the trunk lid is fully open and secure before using the trunk.
- In the following situations, the power trunk opener and closer may detect an abnormality and automatic operation may be stopped. In this case, the trunk lid has to be operated manually. Take extra care in this situation, as the stopped trunk lid may suddenly fall, causing an accident.
  - When the trunk lid contacts an obstacle
  - When the battery voltage suddenly drops, such as when the engine switch is turned to IGNITION ON mode or the engine is started during automatic operation
- Do not attach any accessories other than genuine Lexus parts to the trunk lid. The power trunk opener and closer may not operate, causing itself to malfunction, or the trunk lid may fall closed again after it is opened.

 CAUTION**■ Jam protection function (vehicles with power trunk opener and closer)**

Observe the following precautions.  
Failure to do so may cause serious injury.

- Never use any part of your body to intentionally activate the jam protection function.
- The jam protection function may not work if something gets caught just before the trunk lid fully closes. Be careful not to catch fingers or anything else in the trunk lid.
- The jam protection function may not work depending on the shape of the object that is caught. Be careful not to catch fingers or anything else.

 NOTICE**■ To prevent trunk easy closer malfunctions (vehicles with power trunk opener and closer)**

Do not apply force to the trunk lid while the trunk easy closer is operating.

**■ To prevent damage to the power trunk opener and closer (vehicles with power trunk opener and closer)**

- Make sure that there is no luggage or snow on the trunk lid before operating the power trunk opener and closer. In addition, make sure that there is no ice between the trunk lid and frame that prevents movement of the trunk lid. Operating the power trunk opener and closer when excessive load is present on the trunk lid may cause a malfunction.
- Do not apply excessive force to the trunk lid while the power trunk opener and closer is operating.

## Front seats

### Adjustment procedure

#### ► Type A

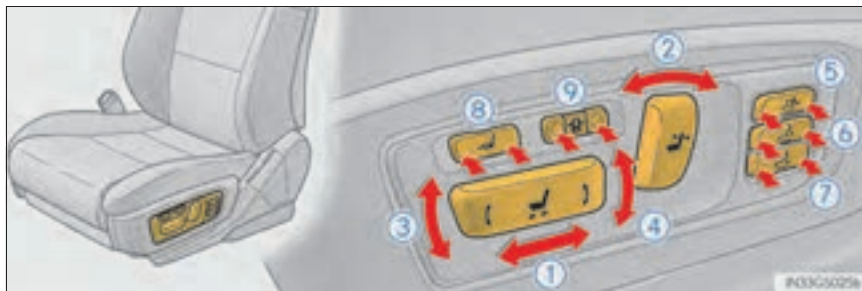

#### ► Type B

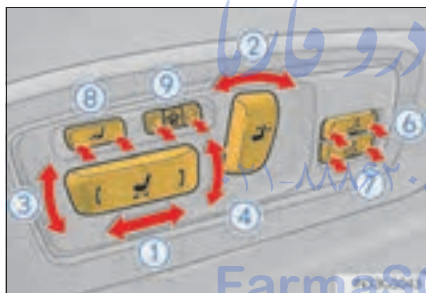

#### ► Type C

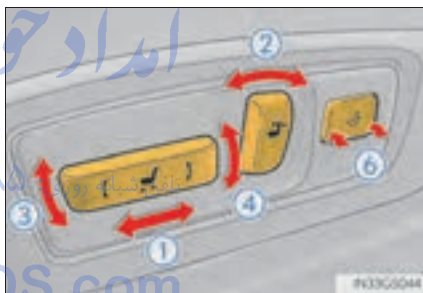

- |  |   |
|--|---|
| ① Seat position adjustment switch                      | ⑥ Lumbar support adjustment switch                      |
| ② Seatback angle adjustment switch                     | ⑦ Pelvic support adjustment switch (if equipped)        |
| ③ Seat cushion (front) angle adjustment switch         | ⑧ Seat cushion length adjustment switch (if equipped)   |
| ④ Vertical height adjustment switch                    | ⑨ Seatback side support adjustment switch (if equipped) |
| ⑤ Seatback upper angle adjustment switch (if equipped) |   |

### ■ Power easy access system

The driver's seat and steering wheel move in accordance with engine switch mode and the driver's seat belt condition. The passenger's seat moves when the passenger's door is opened. (→P. 133)

## ⚠ CAUTION

### ■ When adjusting the seat position

- Take care when adjusting the seat position to ensure that other passengers are not injured by the moving seat.
- Do not put your hands under the seat or near the moving parts to avoid injury. Fingers or hands may become jammed in the seat mechanism.

### ■ Seat adjustment

To reduce the risk of sliding under the lap belt during a collision, do not recline the seat more than necessary.

If the seat is too reclined, the lap belt may slide past the hips and apply restraint forces directly to the abdomen, or your neck may contact the shoulder belt, increasing the risk of death or serious injury in the event of an accident.

Adjustments should not be made while driving as the seat may unexpectedly move and cause the driver to lose control of the vehicle.

### ■ When adjusting the seat positions

Make sure to leave enough space around the feet so they do not get stuck.

## Driving position memory

Your preferred driving position (the position of the driver's seat, steering wheel and outside rear view mirrors) can be memorized and recalled by pressing a button. It is also possible to set this function to activate automatically when the doors are unlocked.

Three different driving positions can be entered into memory.

The same buttons are found on the front passenger's side, allowing the position of the front passenger's seat to be memorized (if equipped).

### Entering a position to memory

- 1 Check that the shift lever is in P.
- 2 Turn the engine switch to IGNITION ON mode.
- 3 Adjust the driver's seat, steering wheel, and outside rear view mirrors to the desired positions. (When memorizing the front passenger's seat, adjust the front passenger's seat to the desired positions.)
- 4 While pressing the "SET" button, or within 3 seconds after the "SET" button is pressed, press button "1", "2" or "3" until the signal beeps.

If the selected button has already been preset, the previously recorded position will be overwritten.





## Recalling the memorized position

- 1 Check that the shift lever is in P.
- 2 Turn the engine switch to IGNITION ON mode.
- 3 Press button "1", "2" or "3" to recall the desired position.



### ■ When you want to stop the position recall operation part-way through

Perform any of the following operations:

- Press the "SET" button.
- Press button "1", "2" or "3".
- Adjust the seat using the switches (only cancels seat position recall).

### ■ The adjusted positions that can be memorized

- ▶ Vehicles without seatback side support adjustment switch

The adjusted positions other than the position adjusted by lumbar support switch can be memorized.

- ▶ Vehicles with seatback side support adjustment switch

All adjusted positions can be memorized.

## Linking driving position memory with door unlock operation (driver's side only)

A desired driving position can be recalled linked with the unlocking of the door.

### ■ Setting procedure

Record your driving position to button "1", "2" or "3" before performing the following:

Carrying only the key to which you want to link the driving position, shift the shift lever to P and then close the driver's door.

If 2 or more keys are in the vehicle, the driving position cannot be linked properly.

- 1 Turn the engine switch to IGNITION ON mode and recall the position which you want to link.
- 2 While pressing the button to recall the position, press the driver's door lock switch (either lock or unlock) until the signal beeps.

The driving position is recalled when the driver's door is unlocked using the entry function or wireless remote control and the driver's door is opened.

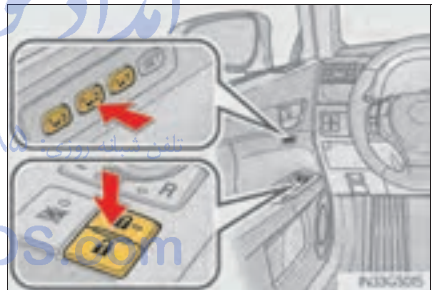

### ■ Cancellation procedure

Carry only the key for which you want to cancel the linked door unlock operation.

If 2 or more keys are in the vehicle, the driving position cannot be canceled properly.

- 1 Turn the engine switch to IGNITION ON mode.
- 2 While pressing the "SET" button, press the driver's door lock switch (either lock or unlock) until the signal beeps.

### Power easy access system

The auto away/return function enables easy access by activating when the driver or front passenger attempts to enter or exit the vehicle.

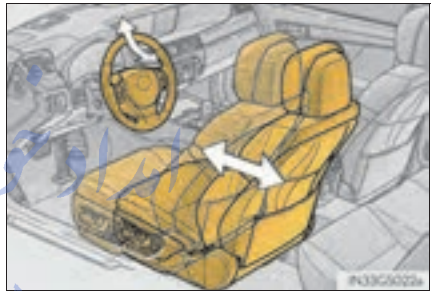

### ■ Auto away function when exiting the vehicle (driver's/front passenger's seat)

- ▶ Driver's seat [FarmaSOS.com](http://FarmaSOS.com)

When all of the following actions have been performed, the steering wheel will move up and back to the point farthest away from the driver and the seat will move backward:

- The shift lever has been shifted to P.
- The engine switch has been turned off.
- The driver seat belt has been unfastened.

- ▶ Front passenger's seat (if equipped)

If the lumbar support, side support (if equipped), etc. of the front passenger's seat has been adjusted, the seat will return to its original state if the front passenger's door is opened while the vehicle is stopped to allow easy exit from the vehicle.

### ■ Auto return function when entering the vehicle (driver's seat only)

When either of the following actions has been performed, the steering wheel will move toward the driver and seat will move forward:

- The engine switch has been turned to ACCESSORY mode.
- The driver's seat belt has been fastened.

### ■ When driving position memory is linked with door unlock operation

If the driver's door is opened, the driver's seat will move toward the memorized position but stop slightly beforehand to allow easy access to the vehicle.

Turning the engine switch to ACCESSORY or IGNITION ON mode, or fastening the driver's seat belt moves the seat fully into the memorized position.

### ■ Operating the driving position memory after turning the engine switch off

Driver's seat:

Memorized seat positions can be activated up to 180 seconds after the driver's door is opened and another 60 seconds after it is closed again. Memorized steering wheel position can be activated by pressing the engine switch.

Front passenger's seat:

Memorized positions can be activated up to 180 seconds after the front passenger's door is opened by pressing button "1", "2" or "3".

### ■ Correct seat position تلفن شبانه روزی: ۰۸۵-۸۸۶۲۰۲۱

When the seat is in the most forward or most backward position, and the seat is being moved in those directions, the system may not correctly recognize the current position and the memorized position will not be correctly recalled.

### ■ The auto away function for exiting the driver's seat

If the seat is already close to the rearmost position, the auto away function may not operate when the driver exits the vehicle.

### ■ Customization

The distance that the driver's seat moves backward during the auto away function can be changed. (Customizable features: →P. 777)

 CAUTION**■ Seat adjustment caution**

Take care during seat adjustment so that the seat does not strike the rear passenger or squeeze your body against the steering wheel.

امداد خودرو فارما

تلفن شبانه روزی: ۰۲۱-۸۸۶۲۰۸۵

FarmaSOS.com

## Head restraints

Head restraints are provided for all seats.

### Front seats

Vertical adjustment

① Up

Pull the head restraints up.

② Down

Push the head restraint down while pressing the lock release button.

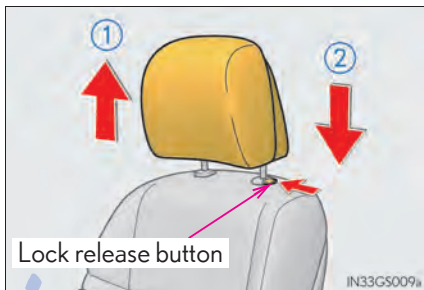

► Angle adjustment (if equipped)

The position of the head restraint can be adjusted forward in 4 stages.

If the head restraint is pulled forward from the foremost position, it will return to the rearmost position.

► Side support adjustment (if equipped)

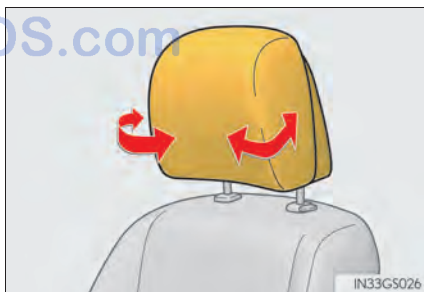
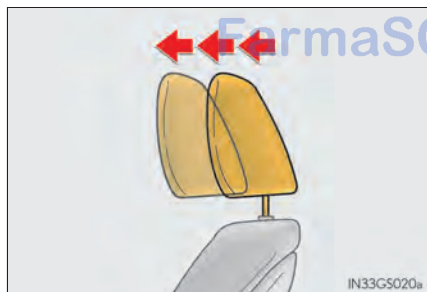

## Rear seats

### ① Up

Pull the head restraints up.

### ② Down

Push the head restraint down while pressing the lock release button.

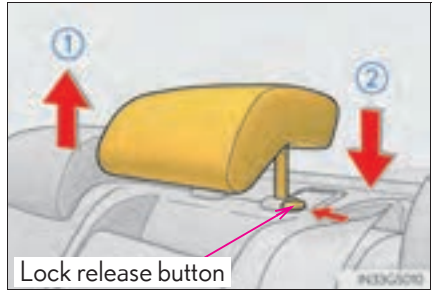

## ■ Removing the head restraints

Pull the head restraint up while pressing the lock release button.

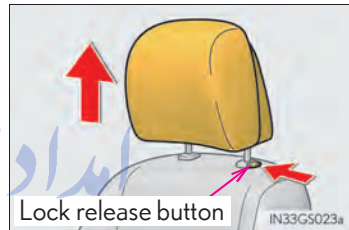

## ■ Installing the head restraints

### ► Front seats

Align the head restraint with the installation holes and push it down to the lock position. Press and hold the lock release button when lowering the head restraint.

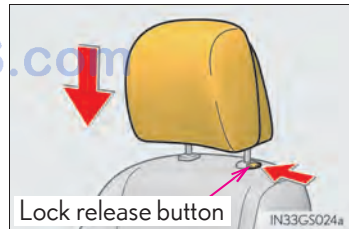

### ► Rear seats

Align the head restraint with the installation holes and push it down to the lowest lock position while pressing the lock release button.

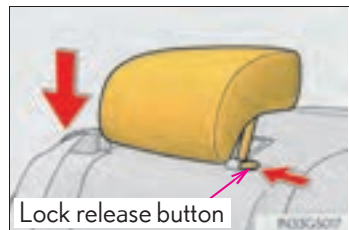

ایراد خودرو فارما

تلفن شبانه روزی: ۰۲۱-۸۸۶۲۰۸۵

PalmasOS.com

### ■ Adjusting the height of the head restraints

Make sure that the head restraints are adjusted so that the center of the head restraint is closest to the top of your ears.

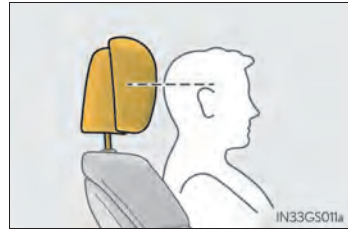

### ■ Adjusting the rear seat head restraint

Always raise the head restraint one level from the stowed position when using.

## ⚠ CAUTION

### ■ Head restraint precautions

Observe the following precautions regarding the head restraints. Failure to do so may result in death or serious injury.

- Use the head restraints designed for each respective seat.
- Adjust the head restraints to the correct position at all times.
- After adjusting the head restraints, push down on them and make sure they are locked in position.
- Do not drive with the head restraints removed.



## Steering wheel

### Adjustment procedure

Operating the switch moves the steering wheel in the following directions:

- ① Up
- ② Down
- ③ Toward the driver
- ④ Away from the driver

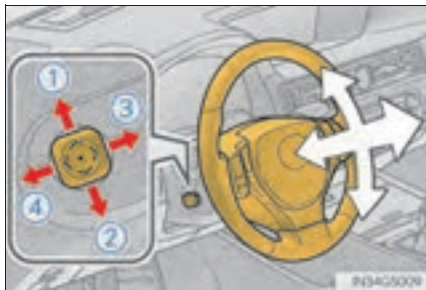

#### ■ The steering wheel can be adjusted when

The engine switch is in ACCESSORY or IGNITION ON mode\*.

\*: If the driver's seat belt is fastened, the steering wheel can be adjusted regardless of engine switch mode.

#### ■ Automatic adjustment of the steering position تلفن شبانه روزی

A desired steering position can be entered to memory and recalled automatically by the driving position memory system. (→P. 130)

#### ■ Power easy access system

The steering wheel and driver's seat move in accordance with engine switch mode and the driver's seat belt condition. (→P. 133)

### ⚠ CAUTION

Do not adjust the steering wheel while driving.  
Doing so may cause the driver to mishandle the vehicle and cause an accident, resulting in death or serious injury.

## Inside rear view mirror

The rear view mirror's position can be adjusted to enable sufficient confirmation of the rear view.

### Adjusting the height of rear view mirror

The height of the rear view mirror can be adjusted to suit your driving posture.

Adjust the height of the rear view mirror by moving it up and down.

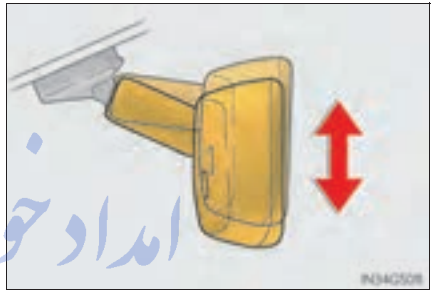

### Anti-glare function

Responding to the level of brightness of the headlights of vehicles behind, the reflected light is automatically reduced.

Changing automatic anti-glare function mode

- ① ON
- ② OFF

When the automatic anti-glare function is in ON mode, the indicator illuminates.

The function will set to ON mode each time the engine switch is turned to IGNITION ON mode.

Pressing the button turns the function to OFF mode. (The indicator also turns off.)

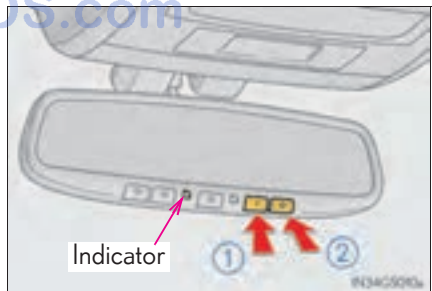

### ■ To prevent sensor error

To ensure that the sensors operate properly, do not touch or cover them.

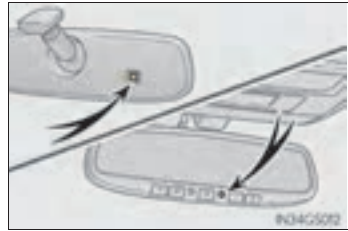

### ⚠ CAUTION

Do not adjust the position of the mirror while driving. Doing so may lead to mishandling of the vehicle and cause an accident, resulting in death or serious injury.

### ⚠ NOTICE

#### ■ Rear view mirror adjustment (vehicles with LKA [Lane-Keeping Assist])

To ensure that the LKA operates properly, make sure that it does not block the LKA camera sensor.



## Outside rear view mirrors

### Adjustment procedure

**1** To select a mirror to adjust, press the switch.

- ① Left
- ② Right

Pressing the same switch again will put the switch in neutral.



**2** To adjust the mirror, press the switch.

- ① Up
- ② Right
- ③ Down
- ④ Left



### Folding the mirrors

Push the mirror back in the direction of the vehicle's rear.



**■ Mirror angle can be adjusted when**

The engine switch is in ACCESSORY or IGNITION ON mode.

**■ Linked mirror function when reversing**

- When either “L” or “R” of the mirror select switch is selected, the outside rear view mirrors will automatically angle downwards when the vehicle is reversing in order to give a better view of the ground. To disable this function, select neither “L” nor “R”.
- If the mirror angle adjustment switch is operated while the linked mirror function is in operation, the angle and position of the mirrors can be remembered, and the mirrors will operate at the angle adjusted to the last time the linked mirror function was operated.

However, because the mirrors move based on the angle they are in when the linked mirror function is not operating, the mirror angle when the linked mirror function is operating will also be changed if the mirrors are adjusted while the function is not operating.

**■ When the mirrors are fogged up**

The outside rear view mirrors can be cleared using the mirror defoggers. Turn on the rear window defogger to turn on the outside rear view mirror defoggers. (→P. 365)

**■ Automatic adjustment of the mirror angle**

A desired mirror face angle can be entered to memory and recalled automatically by the driving position memory. (→P. 130) تلفن شبانه روزی: ۰۲۱-۸۸۸۸۸۸۸۸

**■ Auto anti-glare function**

When the anti-glare inside rear view mirror is set to automatic mode, the outside rear view mirrors will activate in conjunction with the anti-glare inside rear view mirror to reduce reflected light. (→P. 140)

 CAUTION**■ Important points while driving**

Observe the following precautions while driving.

Failure to do so may result in loss of control of the vehicle and cause an accident, resulting in death or serious injury.

- Do not adjust the mirrors while driving.
- Do not drive with the mirrors folded.
- Both the driver and passenger side mirrors must be extended and properly adjusted before driving.

**■ When the mirror defoggers are operating**

Do not touch the rear view mirror surfaces, as they can become very hot and burn you.

امداد خودرو فارما

تلفن شبانه روزی: ۰۲۱-۸۸۶۲۰۸۵

FarmaSOS.com

## Power windows

### Opening and closing procedures

The power windows can be opened and closed using the switches.

Operating the switch moves the windows as follows:

- ① Closing
- ② One-touch closing\*
- ③ Opening
- ④ One-touch opening\*

\*: Pushing the switch in the opposite direction will stop window travel part-way.

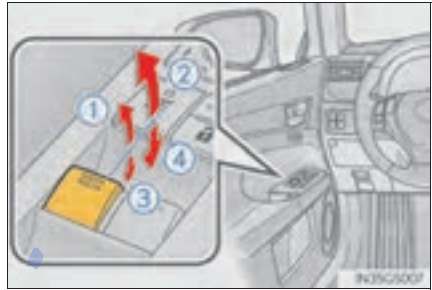

### Window lock switch

Press the switch to lock the passenger window switches.

The indicator will come on.

Use this switch to prevent children from accidentally opening or closing a passenger window.

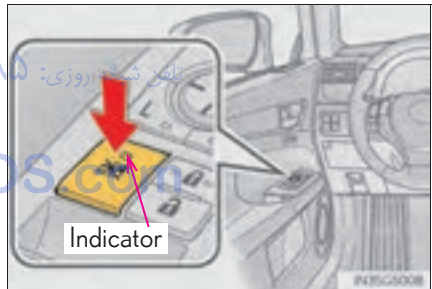

**■ The power windows can be operated when**

The engine switch is in IGNITION ON mode.

**■ Operating the power windows after turning the engine off**

The power windows can be operated for approximately 45 seconds even after the engine switch is turned to ACCESSORY mode or turned off. They cannot, however, be operated once either front door is opened.

**■ Jam protection function**

If an object becomes caught between the window and the window frame, window travel is stopped and the window is opened slightly.

**■ When the power window does not close normally**

If the jam protection function is operating abnormally and a window cannot be closed, perform the following operations using the power window switch on the relevant door.

- After stopping the vehicle, the window can be closed by holding the power window switch in the one-touch closing position while the engine switch is turned to IGNITION ON mode.
- If the window still cannot be closed even by carrying out the operation as explained above, initialize the function by performing the following procedure.
  - 1 Hold the power window switch in the one-touch closing position. Continue holding the switch for a further 6 seconds after the window has closed.
  - 2 Hold the power window switch in the one-touch opening position. Continue holding the switch for a further 2 seconds after the window has opened completely.
  - 3 Hold the power window switch in the one-touch closing position once again. Continue holding the switch for a further 2 seconds after the window has closed.

If you release the switch while the window is moving, start again from the beginning. If the window continues to close but then re-open slightly even after performing the above procedure correctly, have the vehicle inspected by your Lexus dealer.



### ■ Door lock linked window operation

- The power windows can be opened and closed using the mechanical key.\* (→P. 740)
  - The power windows can be opened using the wireless remote control.\* (→P. 114)
- \*: These settings must be customized at your Lexus dealer.

### ■ When the battery is disconnected

The window lock switch is disabled. If necessary, press the window lock switch after reconnecting the battery.

### ■ Power windows open warning buzzer

The buzzer sounds and a message is shown on the multi-information display in the instrument cluster when the engine switch is turned off and the driver's door is opened with the power windows open.

### ■ Customization

Settings (e.g. linked door lock operation) can be changed.  
(Customizable features: →P. 777)

## ⚠ CAUTION

Observe the following precautions.  
Failure to do so may result in death or serious injury.

### ■ Closing the windows

- Check to make sure that all passengers do not have any part of their body in a position where it could be caught when a window is being operated.
- Do not allow children to operate the power windows.  
Closing a power window on someone can cause serious injury, and in some instances, even death.

### ■ Jam protection function

- Never use any part of your body to intentionally activate the jam protection function.
- The jam protection function may not work if something gets caught just before the window fully closes.

## Moon roof

Use the overhead switches to open and close the moon roof and tilt it up and down.

### Opening and closing

#### ① Opens the moon roof\*

The moon roof stops slightly before the fully open position to reduce wind noise.

Press the switch again to fully open the moon roof.

#### ② Closes the moon roof\*

\*: Lightly press either way of the moon roof switch to stop the moon roof partway.



### Tilting up and down

#### ① Tilts the moon roof up\*

#### ② Tilts the moon roof down\*

\*: Lightly press either way of the moon roof switch to stop the moon roof partway.

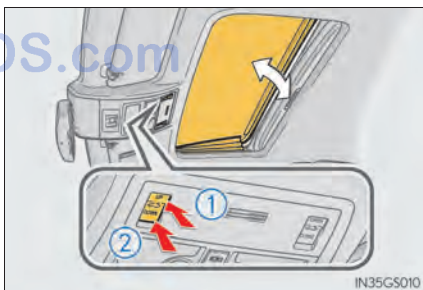

**■ The moon roof can be operated when**

The engine switch is in IGNITION ON mode.

**■ Operating the moon roof after turning the engine off**

The moon roof can be operated for approximately 45 seconds after the engine switch is turned to ACCESSORY mode or turned off. It cannot, however, be operated once either front door is opened.

**■ Jam protection function**

If an object is detected between the moon roof and the frame while the moon roof is closing or tilting down, travel is stopped and the moon roof opens slightly.

**■ Sunshade**

The sunshade can be opened and closed manually. However, the sunshade will open automatically when the moon roof is opened.

**■ Door lock linked moon roof operation**

- The moon roof can be opened and closed using the mechanical key.\* (→P. 740)
- The moon roof can be opened using the wireless remote control.\* (→P. 114)

\*: These settings must be customized at your Lexus dealer.

تلفن شبانه روزی: ۰۲۱-۸۸۶۲۰۸۵

FarmaSOS.com

**■ When the moon roof does not close normally**

Perform the following procedure:

- If the moon roof closes but then re-opens slightly

**1** Stop the vehicle.

**2** Press and hold the “CLOSE” switch.\*<sup>1</sup>

The moon roof will close, reopen and pause for approximately 10 seconds.\*<sup>2</sup> Then it will close again, tilt up and pause for approximately 1 second. Finally, it will tilt down, open and close.

**3** Check to make sure that the moon roof is completely closed and then release the switch.

- If the moon roof tilts down but then tilts back up

**1** Stop the vehicle.

**2** Press and hold the “UP” switch\*<sup>1</sup> until the moon roof moves into the tilt up position and stops.

**3** Release the “UP” switch once and then press and hold the “UP” switch again.\*<sup>1</sup> The moon roof will pause for approximately 10 seconds in the tilt up position.\*<sup>2</sup> Then it will adjust slightly and pause for approximately 1 second. Finally, it will tilt down, open and close.

**4** Check to make sure that the moon roof is completely closed and then release the switch.

\*<sup>1</sup>: If the switch is released at the incorrect time, the procedure will have to be performed again from the beginning.

\*<sup>2</sup>: If the switch is released after the above mentioned 10 second pause, automatic operation will be disabled. In that case, press and hold the “CLOSE” or “UP” switch, and the moon roof will tilt up and pause for approximately 1 second. Then it will tilt down, open and close. Check to make sure that the moon roof is completely closed and then release the switch.

If the moon roof does not fully close even after performing the above procedure correctly, have the vehicle inspected by your Lexus dealer.

### ■ Moon roof open warning buzzer

The buzzer sounds and a message is shown on the multi-information display in the instrument cluster when the engine switch is turned off and the driver's door is opened with the moon roof open.

### ■ Customization

Settings (e.g. linked door lock operation) can be changed.  
(Customizable features: →P. 777)

## CAUTION

Observe the following precautions.  
Failure to do so may cause death or serious injury.

### ■ Opening the moon roof

- Do not allow any passengers to put their hands or heads outside the vehicle while it is moving.
- Do not sit on top of the moon roof.

### ■ Closing the moon roof

- Check to make sure that all passengers do not have any part of their body in a position where it could be caught when the moon roof is being operated.
- Do not allow children to operate the moon roof.  
Closing the moon roof on someone can cause death or serious injury.

### ■ Jam protection function

- Never use any part of your body to intentionally activate the jam protection function.
- The jam protection function may not work if something gets caught just before the moon roof fully closes.

امداد خودرو فارما

تلفن شبانه روزی: ۰۲۱-۸۸۸۶۲۰۸۵

[FarmaSOS.com](http://FarmaSOS.com)

**4-1. Before driving**

Driving the vehicle .....	154
Cargo and luggage .....	165
Vehicle load limits .....	168
Trailer towing.....	169
Dinghy towing.....	170

**4-2. Driving procedures**

Engine (ignition) switch .....	171
Automatic transmission .....	178
Turn signal lever .....	184
Parking brake .....	186
Horn.....	189

**4-3. Operating the lights and wipers**

Headlight switch.....	190
Fog light switch .....	195
Windshield wipers and washer.....	196
Headlight cleaner switch.....	203

**4-4. Refueling**

Opening the fuel tank cap .....	204
---------------------------------	-----

**4-5. Using the driving support systems**

Cruise control .....	209
Dynamic radar cruise control.....	213
LKA (Lane-Keeping Assist).....	228
Intuitive parking assist .....	238
Rear view monitor system .....	251
Drive mode select switch .....	263
Driving assist systems.....	268
Hill-start assist control .....	276
PCS (Pre-Collision System).....	278
BSM (Blind Spot Monitor).....	287
Lexus night view .....	293

**4-6. Driving tips**

Winter driving tips .....	298
---------------------------	-----

ایراد خودرو فارما

تلفن شبانه (۲۴ ساعته): ۰۲۱-۸۸۶۲۰۸۵

FarmaSOS.com

## Driving the vehicle

The following procedures should be observed to ensure safe driving:

### Starting the engine

→P.171

### Driving

- 1 With the brake pedal depressed, shift the shift lever to D. (→P.178)
- 2 If the parking brake is in manual mode, release the parking brake. (→P.186)
- 3 Gradually release the brake pedal and gently depress the accelerator pedal to accelerate the vehicle.

### Stopping

- 1 With the shift lever in D, depress the brake pedal.
- 2 If necessary, set the parking brake.

If the vehicle is to be stopped for an extended period of time, shift the shift lever to P or N. (→P.178)

### Parking the vehicle

- 1 With the shift lever in D, depress the brake pedal.
- 2 If the parking brake is in manual mode, set the parking brake. (→P.186)
- 3 Shift the shift lever to P. (→P.178)  
If parking on a hill, block the wheels as needed.
- 4 Press the engine switch to stop the engine.
- 5 Lock the door, making sure that you have the electronic key on your person.



## Starting off on a steep uphill

- 1 Make sure that the parking brake is set and shift the shift lever to D.
- 2 Gently depress the accelerator pedal.
- 3 Release the parking brake.

---

### ■ When starting off on a uphill

The hill-start assist control is available. (→P. 276)

### ■ Driving in the rain

- Drive carefully when it is raining, because visibility will be reduced, the windows may become fogged-up, and the road will be slippery.
- Drive carefully when it starts to rain, because the road surface will be especially slippery.
- Refrain from high speeds when driving on an expressway in the rain, because there may be a layer of water between the tires and the road surface, preventing the steering and brakes from operating properly.

### ■ Engine speed while driving

In the following conditions, the engine speed may become high while driving. This is due to automatic up-shifting control or down-shifting implementation to meet driving conditions. It does not indicate sudden acceleration.

- The vehicle is judged to be driving uphill or downhill
- When the accelerator pedal is released
- When sport mode is selected (→P. 263)

### ■ Breaking in your new Lexus

To extend the life of the vehicle, observing the following precautions is recommended:

- For the first 186 miles (300 km):  
Avoid sudden stops.
- For the first 621 miles (1000 km):
  - Do not drive at extremely high speeds.
  - Avoid sudden acceleration.
  - Do not drive continuously in low gears.
  - Do not drive at a constant speed for extended periods.

### ■ Drum-in-disc type parking brake system

Your vehicle has a drum-in-disc type parking brake system. This type of brake system needs bedding-down of the brake shoes periodically or whenever the parking brake shoes and/or drum are replaced. Have your Lexus dealer perform the bedding down operation.

### ■ Operating your vehicle in a foreign country

Comply with the relevant vehicle registration laws and confirm the availability of the correct fuel. (→P. 762)

تلفن شبانه روزی: ۰۲۱-۸۸۶۲۰۸۵

FarmaSOS.com

**⚠ CAUTION**

Observe the following precautions.  
Failure to do so may result in death or serious injury.

**■ When starting the vehicle**

Always keep your foot on the brake pedal while stopped with the engine running.  
This prevents the vehicle from creeping.

**■ When driving the vehicle**

- Do not drive if you are unfamiliar with the location of the brake and accelerator pedals to avoid depressing the wrong pedal.
  - Accidentally depressing the accelerator pedal instead of the brake pedal will result in sudden acceleration that may lead to an accident.
  - When backing up, you may twist your body around, leading to a difficulty in operating the pedals. Make sure to operate the pedals properly.
  - Make sure to keep a correct driving posture even when moving the vehicle only slightly. This allows you to depress the brake and accelerator pedals properly.
  - Depress the brake pedal using your right foot. Depressing the brake pedal using your left foot may delay response in an emergency, resulting in an accident.
- Do not drive the vehicle over or stop the vehicle near flammable materials. The exhaust system and exhaust gases can be extremely hot. These hot parts may cause a fire if there is any flammable material nearby.

**⚠ CAUTION**

Observe the following precautions.  
Failure to do so may result in death or serious injury.

**■ When driving the vehicle**

- During normal driving, do not turn off the engine. Turning the engine off while driving will not cause loss of steering or braking control, but the power assist to these systems will be lost. This will make it more difficult to steer and brake, so you should pull over and stop the vehicle as soon as it is safe to do so.  
However, in the event of an emergency, such as if it becomes impossible to stop the vehicle in the normal way: →P. 677
- Use engine braking (downshift) to maintain a safe speed when driving down a steep hill.  
Using the brakes continuously may cause the brakes to overheat and lose effectiveness. (→P. 178)
- Do not adjust the positions of the steering wheel, the seat, or the inside or outside rear view mirrors while driving.  
Doing so may result in a loss of vehicle control.
- Always check that all passengers' arms, heads or other parts of their body are not outside the vehicle.
- Do not drive in excess of the speed limit. Even if the legal speed limit permits it, do not drive over 85 mph (140 km/h) unless your vehicle has high-speed capability tires. Driving over 85 mph (140 km/h) may result in tire failure, loss of control and possible injury. Be sure to consult a tire dealer to determine whether the tires on your vehicle are high-speed capability tires or not before driving at such speeds.

**⚠ CAUTION**

Observe the following precautions.  
Failure to do so may result in death or serious injury.

**■ When driving on slippery road surfaces**

- Sudden braking, acceleration and steering may cause tire slippage and reduce your ability to control the vehicle.
- Sudden acceleration, engine braking due to shift changing, or changes in engine speed could cause the vehicle to skid.
- After driving through a puddle, lightly depress the brake pedal to make sure that the brakes are functioning properly. Wet brake pads may prevent the brakes from functioning properly. If the brakes on only one side are wet and not functioning properly, steering control may be affected.

**■ When shifting the shift lever**

- Do not let the vehicle roll backward while the shift lever is in a driving position, or roll forward while the shift lever is in R.  
Doing so may cause the engine to stall or lead to poor brake and steering performance, resulting in an accident or damage to the vehicle.
- Do not shift the shift lever to P while the vehicle is moving.  
Doing so can damage the transmission and may result in a loss of vehicle control.
- Do not shift the shift lever to R while the vehicle is moving forward.  
Doing so can damage the transmission and may result in a loss of vehicle control.
- Do not shift the shift lever to D while the vehicle is moving backward.  
Doing so can damage the transmission and may result in a loss of vehicle control.
- Moving the shift lever to N while the vehicle is moving will disengage the engine from the transmission. Engine braking is not available when N is selected.
- Be careful not to shift the shift lever with the accelerator pedal depressed. Shifting the shift lever to a gear other than P or N may lead to unexpected rapid acceleration of the vehicle that may cause an accident and result in death or serious injury.

**⚠ CAUTION****■ If you hear a squealing or scraping noise (brake pad wear limit indicators)**

Have the brake pads checked and replaced by your Lexus dealer as soon as possible.

Rotor damage may result if the pads are not replaced when needed.

Front brakes only: Moderate levels of brake pad and disc wear allow enhanced front braking power. As a result, the discs may wear more quickly than conventional brake discs. Therefore, when replacing the brake pads, Lexus recommends that you also have the thickness of the discs measured.

It is dangerous to drive the vehicle when the wear limits of the brake pads and/or those of the brake discs are exceeded.

**■ When the vehicle is stopped****● Do not race the engine.**

If the vehicle is in any gear other than P or N, the vehicle may accelerate suddenly and unexpectedly, causing an accident.

**● In order to prevent accidents due to the vehicle rolling away, always keep depressing the brake pedal while the engine is running, and apply the parking brake as necessary.****● If the vehicle is stopped on an incline, in order to prevent accidents caused by the vehicle rolling forward or backward, always depress the brake pedal and securely apply the parking brake as needed.****● Avoid revving or racing the engine.**

Running the engine at high speed while the vehicle is stopped may cause the exhaust system to overheat, which could result in a fire if combustible material is nearby.

 CAUTION**■ When the vehicle is parked**

- Do not leave glasses, cigarette lighters, spray cans, or soft drink cans in the vehicle when it is in the sun.  
Doing so may result in the following:
  - Gas may leak from a cigarette lighter or spray can, and may lead to a fire.
  - The temperature inside the vehicle may cause the plastic lenses and plastic material of glasses to deform or crack.
  - Soft drink cans may fracture, causing the contents to spray over the interior of the vehicle, and may also cause a short circuit in the vehicle's electrical components.
- Do not leave cigarette lighters in the vehicle. If a cigarette lighter is in a place such as the glove box or on the floor, it may be lit accidentally when luggage is loaded or the seat is adjusted, causing a fire.
- Do not attach adhesive discs to the windshield or windows. Do not place containers such as air fresheners on the instrument panel or dashboard. Adhesive discs or containers may act as lenses, causing a fire in the vehicle.
- Do not leave a door or window open if the curved glass is coated with a metalized film such as a silver-colored one. Reflected sunlight may cause the glass to act as a lens, causing a fire.
- Always apply the parking brake, shift the shift lever to P, stop the engine and lock the vehicle.  
Do not leave the vehicle unattended while the engine is running.
- Do not touch the exhaust pipes while the engine is running or immediately after turning the engine off.  
Doing so may cause burns.

**⚠ CAUTION****■ When taking a nap in the vehicle**

Always turn the engine off. Otherwise, if you accidentally move the shift lever or depress the accelerator pedal, this could cause an accident or fire due to engine overheating. Additionally, if the vehicle is parked in a poorly ventilated area, exhaust gases may collect and enter the vehicle, leading to death or a serious health hazard.

**■ When braking**

- When the brakes are wet, drive more cautiously.

Braking distance increases when the brakes are wet, and this may cause one side of the vehicle to brake differently than the other side. Also, the parking brake may not securely hold the vehicle.

- If the power brake assist function does not operate, do not follow other vehicles closely and avoid hills or sharp turns that require braking.

In this case, braking is still possible, but the brake pedal should be depressed more firmly than usual. Also, the braking distance will increase.

- The brake system consists of 2 individual hydraulic systems; if one of the systems fails, the other will still operate. In this case, the brake pedal should be depressed more firmly than usual and the braking distance will increase.

If this happens, do not continue to drive the vehicle. Have your brakes fixed immediately.

تلفن شبانه روزی: ۰۲۱-۸۸۶۲۰۸۵

**■ If the vehicle becomes stuck**

Do not spin the wheels excessively when any of the tires is up in the air, or the vehicle is stuck in sand, mud, etc. This may damage the driveline components or propel the vehicle forward or backward, causing an accident.



 NOTICE

### ■ When driving the vehicle

- Do not depress the accelerator and brake pedals at the same time during driving, as this may restrain driving torque.
- Do not use the accelerator pedal or depress the accelerator and brake pedals at the same time to hold the vehicle on a hill.

### ■ When parking the vehicle

Always shift the shift lever to P. Failure to do so may cause the vehicle to move or the vehicle may accelerate suddenly if the accelerator pedal is accidentally depressed.

### ■ Avoiding damage to vehicle parts

- Do not turn the steering wheel fully in either direction and hold it there for an extended period of time.  
Doing so may damage the power steering motor.
- When driving over bumps in the road, drive as slowly as possible to avoid damaging the wheels, underside of the vehicle, etc.

### ■ If you get a flat tire while driving

A flat or damaged tire may cause the following situations. Hold the steering wheel firmly and gradually depress the brake pedal to slow down the vehicle.

- It may be difficult to control your vehicle. تلفن شبانه روزی: ۰۲۱-۶۶۱۱۱۰۱۵
- The vehicle will make abnormal sounds or vibrations.
- The vehicle will lean abnormally.

Information on what to do in case of a flat tire (→P. 722)

 NOTICE**■ When encountering flooded roads**

Do not drive on a road that has flooded after heavy rain etc. Doing so may cause the following serious damage to the vehicle:

- Engine stalling
- Short in electrical components
- Engine damage caused by water immersion

In the event that you drive on a flooded road and the vehicle is flooded, be sure to have your Lexus dealer check the following:

- Brake function
- Changes in quantity and quality of oil and fluid used for the engine, transmission, transfer (AWD models), differential, etc.
- Lubricant condition for the propeller shaft, bearings and suspension joints (where possible), and the function of all joints, bearings, etc.

امداد خودرو فارما

تلفن شبانه روزی: ۰۲۱-۸۸۶۲۰۸۵

FarmaSOS.com

## Cargo and luggage

Take notice of the following information about storage precautions, cargo capacity and load:

### Capacity and distribution

Cargo capacity depends on the total weight of the occupants.

(Cargo capacity) = (Total load capacity) – (Total weight of occupants)

#### Steps for Determining Correct Load Limit –

- (1) Locate the statement “The combined weight of occupants and cargo should never exceed XXX kg or XXX lbs.” on your vehicle’s placard.
- (2) Determine the combined weight of the driver and passengers that will be riding in your vehicle.
- (3) Subtract the combined weight of the driver and passengers from XXX kg or XXX lbs.
- (4) The resulting figure equals the available amount of cargo and luggage load capacity.  
 For example, if the “XXX” amount equals 1400 lbs. and there will be five 150 lb passengers in your vehicle, the amount of available cargo and luggage load capacity is 650 lbs. (1400 – 750 (5 × 150) = 650 lbs.)
- (5) Determine the combined weight of luggage and cargo being loaded on the vehicle. That weight may not safely exceed the available cargo and luggage load capacity calculated in Step 4.
- (6) If your vehicle will be towing a trailer, load from your trailer will be transferred to your vehicle. Consult this manual to determine how this reduces the available cargo and luggage load capacity of your vehicle. (→P. 168)

Lexus does not recommend towing a trailer with your vehicle. Your vehicle is not designed for trailer towing.

### Example based on your vehicle

- ① Cargo capacity
- ② Total load capacity

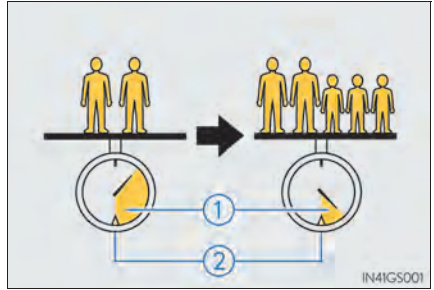

When 2 people with the combined weight of 366 lb. (166 kg) are riding in your vehicle, which has a total load capacity of 825 lb. (370 kg), the available amount of cargo and luggage load capacity will be as follows:

$$825 \text{ lb.} - 366 \text{ lb.} = 459 \text{ lb.} \quad (370 \text{ kg} - 166 \text{ kg} = 204 \text{ kg})$$

In this condition, if 3 more passengers with the combined weight of 388 lb. (176 kg) get on, the available cargo and luggage load will be reduced as follows:

$$459 \text{ lb.} - 388 \text{ lb.} = 71 \text{ lb.} \quad (204 \text{ kg} - 176 \text{ kg} = 28 \text{ kg})$$

As shown in the example above, if the number of occupants increases, the cargo and luggage load will be reduced by an amount that equals the increased weight due to the additional occupants. In other words, if an increase in the number of occupants causes an excess of the total load capacity (combined weight of occupants plus cargo and luggage load), you must reduce the cargo and luggage on your vehicle.

**⚠ CAUTION****■ Things that must not be carried in the trunk**

The following things may cause a fire if loaded in the trunk:

- Receptacles containing gasoline
- Aerosol cans

**■ Storage precautions**

Observe the following precautions.

Failure to do so may prevent the pedals from being depressed properly, may block the driver's vision, or may result in items hitting the driver or passengers, possibly causing an accident.

- Stow cargo and luggage in the trunk whenever possible.
- Do not place cargo or luggage in or on the following locations.
  - At the feet of the driver
  - On the front passenger or rear seats (when stacking items)
  - On the package tray
  - On the instrument panel
  - On the dashboard
  - In front of the Remote Touch screen
- Secure all items in the occupant compartment.

**■ Capacity and distribution**

- Do not exceed the maximum axle weight rating or the total vehicle weight rating.
- Even if the total load of occupant's weight and the cargo load is less than the total load capacity, do not apply the load unevenly. Improper loading may cause deterioration of steering or braking control which may cause death or serious injury.

## Vehicle load limits

Vehicle load limits include total load capacity, seating capacity, towing capacity and cargo capacity.

### ◆ Total load capacity: 825 lb. (370 kg)

Total load capacity means the combined weight of occupants, cargo and luggage.

### ◆ Seating capacity: 5 occupants (Front 2, Rear 3)

Seating capacity means the maximum number of occupants whose estimated average weight is 150 lb. (68 kg) per person.

### ◆ Towing capacity

Lexus does not recommend towing a trailer with your vehicle.

### ◆ Cargo capacity

Cargo capacity may increase or decrease depending on the weight and the number of occupants.

### ■ Total load capacity and seating capacity

These details are also described on the tire and loading information label. (→P. 639)

### CAUTION

#### ■ Overloading the vehicle

Do not overload the vehicle.

It may not only cause damage to the tires, but also degrade steering and braking ability, resulting in an accident.

## Trailer towing

Lexus does not recommend towing a trailer with your vehicle. Lexus also does not recommend the installation of a tow hitch or the use of a tow hitch carrier for a wheelchair, scooter, bicycle, etc. Your vehicle is not designed for trailer towing or for the use of tow hitch mounted carriers.



امداد خودرو فارما

تلفن شبانه روزی: ۰۲۱-۸۸۶۲۰۸۵

[FarmaSOS.com](http://FarmaSOS.com)

## Dinghy towing

Your vehicle is not designed to be dinghy towed (with 4 wheels on the ground) behind a motor home.

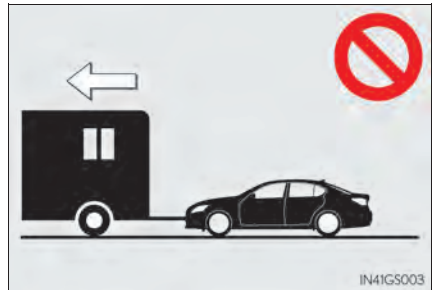

### NOTICE

■ To avoid serious damage to your vehicle

Do not tow your vehicle with the four wheels on the ground.

تلفن شبانه روزی: ۰۲۱-۸۸۶۲۰۸۵

[FarmaSOS.com](http://FarmaSOS.com)



## Engine (ignition) switch

Performing the following operations when carrying the electronic key on your person starts the engine or changes engine switch modes.

### Starting the engine

- 1 Check that the parking brake is set.
- 2 Check that the shift lever is set in P.
- 3 Firmly depress the brake pedal.



will be displayed on the multi-information display.

If it is not displayed, the engine cannot be started.

- 4 Press the engine switch.

The engine will crank until it starts or for up to 30 seconds, whichever is less.

Continue depressing the brake pedal until the engine is completely started.

The engine can be started from any engine switch mode.



## Stopping the engine

- 1 Stop the vehicle.
- 2 Shift the shift lever to P.
- 3 Set the parking brake. (→P. 186)
- 4 Press the engine switch.
- 5 Release the brake pedal and check that "POWER ON" on the multi-information display is off.

## Changing engine switch modes

Modes can be changed by pressing the engine switch with brake pedal released. (The mode changes each time the switch is pressed.)

Off\*

The emergency flashers can be used.

The multi-information display will not be displayed.

ACCESSORY mode

Some electrical components such as the audio system can be used.

"POWER ON" will be displayed on the multi-information display.

IGNITION ON mode

All electrical components can be used.

"POWER ON" will be displayed on the multi-information display.

- \*: If the shift lever is in a position other than P when turning off the engine, the engine switch will be turned to ACCESSORY mode, not to off.



## When stopping the engine with the shift lever in a position other than P

If the engine is stopped with the shift lever in a position other than P, the engine switch will not be turned off but instead be turned to ACCESSORY mode. Perform the following procedure to turn the switch off:

- 1 Check that the parking brake is set.
- 2 Shift the shift lever to P.
- 3 Check that "POWER ON" and "Turn Power OFF" are displayed alternately on the multi-information display and then press the engine switch once.
- 4 Check that "POWER ON" and "Turn Power OFF" on the multi-information display are off.

امداد خودرو فارما

تلفن شبانه روزی: ۰۲۱-۸۸۶۲۰۸۵

FarmaSOS.com

**■ Auto power off function**

If the vehicle is left in ACCESSORY mode for more than 20 minutes or IGNITION ON mode (the engine is not running) for more than an hour with the shift lever in P, the engine switch will automatically turn off. However, this function cannot entirely prevent battery discharge. Do not leave the vehicle with the engine switch in ACCESSORY or IGNITION ON mode for long periods of time when the engine is not running.

**■ Electronic key battery depletion**

→P. 112

**■ Conditions affecting operation**

→P. 108

**■ Notes for the entry function**

→P. 109

**■ If the engine does not start**

- The engine immobilizer system may not have been deactivated. (→P. 68)  
Contact your Lexus dealer.
- Check that the shift lever is securely set in P. The engine may not start if the shift lever is displaced out of P. "Shift to P position to Start" will be displayed on the multi-information display.

**■ Steering lock**

After turning the engine switch off and opening and closing the doors, the steering wheel will be locked due to the steering lock function. Operating the engine switch again automatically cancels the steering lock.

### ■ When the steering lock cannot be released

“Steering Lock active” will be displayed on the multi-information display.

Check that the shift lever is set in P. Press the engine switch while turning the steering wheel left and right.



### ■ Steering lock motor overheating prevention

To prevent the steering lock motor from overheating, the motor may be suspended if the engine is turned on and off repeatedly in a short period of time. In this case, refrain from operating the engine. After about 10 seconds, the steering lock motor will resume functioning.

### ■ When “Check Access System with Elec. Key” will be displayed on the multi-information display

The system may be malfunctioning. Have the vehicle inspected by your Lexus dealer immediately.

### ■ If the electronic key battery is depleted

→P. 646

### ■ Operation of the engine switch

- When operating the engine switch, one short, firm press is enough. If the switch is pressed improperly, the engine may not start or the engine switch mode may not change. It is not necessary to press and hold the switch.
- If attempting to restart the engine immediately after turning the engine switch off, the engine may not start in some cases. After turning the engine switch off, please wait a few seconds before restarting the engine.

### ■ If the smart access system with push-button start has been deactivated in a customized setting

→P. 740

**⚠ CAUTION****■ When starting the engine**

Always start the engine while sitting in the driver's seat. Do not depress the accelerator pedal while starting the engine under any circumstances. Doing so may cause an accident resulting in death or serious injury.

**■ Caution while driving**

If engine failure occurs while the vehicle is moving, do not lock or open the doors until the vehicle reaches a safe and complete stop. Activation of the steering lock in this circumstance may lead to an accident, resulting in death or serious injury.

**■ Stopping the engine in an emergency**

If you want to stop the engine in an emergency while driving the vehicle, press and hold the engine switch for more than 2 seconds, or press it briefly 3 times or more in succession. (→P. 677)

However, do not touch the engine switch while driving except in an emergency. Turning the engine off while driving will not cause loss of steering or braking control, but the power assist to these systems will be lost. This will make it more difficult to steer and brake, so you should pull over and stop the vehicle as soon as it is safe to do so.

تلفن شبانه روزی: ۰۲۱-۸۸۶۲۰۸۵

FarmaSOS.com

 NOTICE**■ To prevent battery discharge**

- Do not leave the engine switch in ACCESSORY or IGNITION ON mode for long periods of time without the engine running.
- If "POWER ON" is displayed on the multi-information display, the engine switch is not off. Exit the vehicle after turning the engine switch off.
- Do not stop the engine when the shift lever is in a position other than P. If the engine is stopped in another shift lever position, the engine switch will not be turned off but instead be turned to ACCESSORY mode. If the vehicle is left in ACCESSORY mode, battery discharge may occur.

**■ When starting the engine**

- Do not race a cold engine.
- If the engine becomes difficult to start or stalls frequently, have your vehicle checked by your Lexus dealer immediately.

**■ Symptoms indicating a malfunction with the engine switch**

If the engine switch seems to be operating somewhat differently than usual, such as the switch sticking slightly, there may be a malfunction. Contact your Lexus dealer immediately.

تلفن شبانه روزی: ۰۲۱-۸۸۶۲۰۸۵

FarmaSOS.com

## Automatic transmission

### Shifting the shift lever

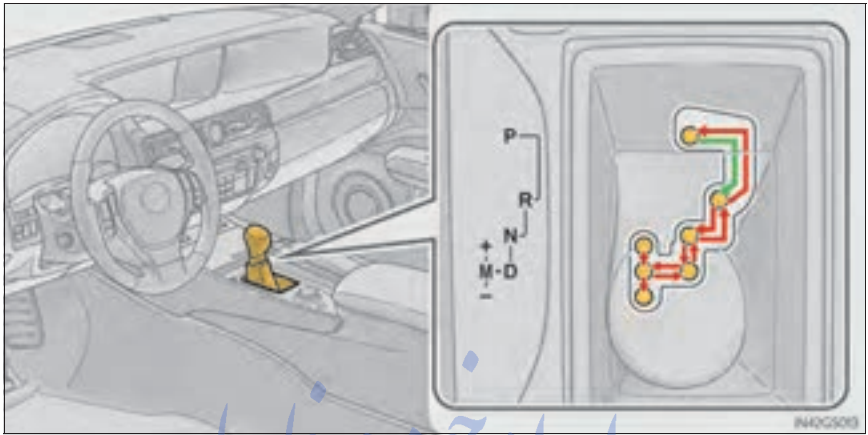

- ← While the engine switch is in IGNITION ON mode, move the shift lever with the brake pedal depressed.

When shifting the shift lever between P and D, make sure that the vehicle is completely stopped. تلفن شبانه روزی: ۰۲۱-۸۸۸۸۸۸۸۸



## Shift position purpose

Shift position	Objective or function
P	Parking the vehicle/starting the engine
R	Reversing
N	Neutral
D	Normal driving <sup>*1</sup>
M	M mode driving <sup>*2</sup> (→P. 181)

\*1: To improve fuel efficiency and reduce noises, set the shift lever in D for normal driving.

\*2: Any gear range can be fixed when driving in M mode.

## Selecting the driving mode

### ■ Sport mode/Eco drive mode

→P. 263

### ■ Snow mode

Snow mode can be selected to suit the conditions when driving on slippery road surfaces, such as on snow.

Press the switch.

Press the switch again to return to normal mode.



## Selecting shift ranges in the D position

To drive using temporary shift range selection, operate the “-” paddle shift switch. The shift range can then be selected by operating the “-” and “+” paddle shift switches. Changing the shift range allows restriction of the highest gear, preventing unnecessary upshifting and enabling the level of engine braking force to be selected.

### ① Upshifting

### ② Downshifting

The selected shift range, from D1 to D5, will be displayed in the meter.

To return to normal D position driving, the “+” paddle shift switch must be held down for a period of time.



## ■ Shift ranges and their functions

Meter display	Function
D2 - D5	A gear in the range between 1 and the selected gear is automatically chosen depending on vehicle speed and driving conditions
D1	Setting the gear at 1

A lower shift range will provide greater engine braking forces than a higher shift range.

## Selecting gears in the M position

To enter M mode, shift the shift lever to M. Gears can then be selected by operating the shift lever or paddle shift switches, allowing you to drive in the gear of your choosing.

### ① Upshifting

### ② Downshifting

The gear changes once every time the shift lever or paddle shift switch is operated.

The selected gear, from M1 to M6, will be fixed and displayed in the meter.

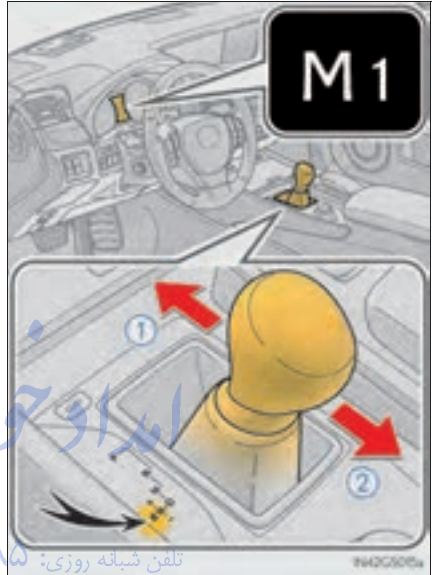

When in the M position, the gear will not change unless the shift lever or paddle shift switches are operated.

However, even when in the M position, the gears will be automatically changed in the following situation:

- When vehicle speed drops (downshift only).
- When the automatic transmission fluid or engine coolant temperature is low.
- When automatic transmission fluid temperature is high.
- When the needle of the tachometer is in the red zone (the range which exceeds the allowable revs of the engine).

In the following situations, the gear will not shift even if the shift lever or paddle shift switches are operated.

- “1st Gear not available due to slippery road surface” is displayed on the multi information display.
- The vehicle speed is low (upshift only).

---

#### ■ When the “-” paddle shift switch is operated in the D position

A shift range will be automatically selected. The highest gear of the first shift range will be one gear lower than the gear in use during normal D position driving.

#### ■ Automatic deactivation of shift range selection in the D position

Shift range selection in the D position will be deactivated in the following situations:

- When the vehicle comes to a stop
- If the “+” paddle shift switch is operated when the shift range is in 5
- If the accelerator pedal is depressed for more than a certain period of time
- When the shift lever is shifted to other than D

#### ■ To protect automatic transmission

“Transmission Fluid High Temperature” is displayed on the multi-information display and a function is adopted that automatically selects a higher shift range when the fluid temperature is high. Have the vehicle inspected by your Lexus dealer.

#### ■ Downshifting restrictions warning buzzer

To help ensure safety and driving performance, downshifting operation may sometimes be restricted. In some circumstances, downshifting may not be possible even when the shift lever or paddle shift switch is operated. (A buzzer will sound twice.)

#### ■ Snow mode automatic deactivation

Snow mode is automatically deactivated if the engine switch is turned off after driving in snow mode.

#### ■ If the shift lever cannot be shifted from P

→P. 737

### ■ AI-SHIFT

The AI-SHIFT automatically selects the suitable gear according to driver performance and driving conditions.

The AI-SHIFT automatically operates when the shift lever is in D. (Shifting the shift lever to the M position cancels the function.)

### CAUTION

#### ■ When driving on slippery road surfaces

Be careful of downshifting and sudden acceleration, as this could result in the vehicle skidding to the side or spinning.

امداد خودرو فارما

تلفن شبانه روزی: ۰۲۱-۸۸۶۲۰۸۵

FarmaSOS.com

## Turn signal lever

### Operating instructions

The lever will return to its original position after operation.

- ① Right turn
- ② Lane change to the right (move the lever partway and release it)  
The right hand signals will flash 3 times.
- ③ Lane change to the left (move the lever partway and release it)  
The left hand signals will flash 3 times.
- ④ Left turn

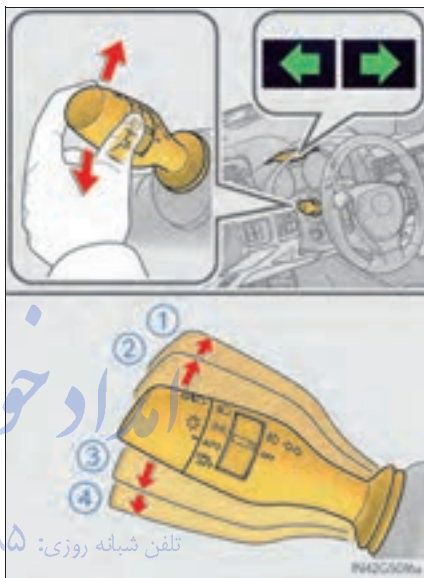

- If the turn signals do not stop flashing after turning left or right, or if you want to stop them flashing

Operate the lever in the opposite direction to either position ② or ③. If you move the lever to either position ① or ④, the selected turn signals will flash.

**■ Turn signals can be operated when**

The engine switch is in IGNITION ON mode.

**■ If the indicator flashes faster than usual**

Check that a light bulb in the front or rear turn signal lights has not burned out.

**■ If the turn signals stop flashing before a lane change has been performed**

Operate the lever again.

**■ Customization**

The number of times the turn signals flash during a lane change can be changed.  
(Customizable feature →P. 777)

امداد خودرو فارما

تلفن شبانه روزی: ۰۲۱-۸۸۶۲۰۸۵

FarmaSOS.com

## Parking brake

A selections can be made as desired from the following modes.

### Manual mode

#### ① Sets the parking brake

The parking brake indicator light will come on. (→P.187)

Press and hold the parking brake switch if an emergency occurs and it is necessary to operate the parking brake while driving.

#### ② Releases the parking brake

Operate the parking brake switch while depressing the brake pedal. Make sure that the parking brake indicator light goes off.





## Automatic mode

The parking brake is set or released automatically according to shift lever operation.

Turns automatic mode on/off

- When the shift lever is moved out of P, the parking brake will be released.
- When the shift lever is moved into P, the parking brake will be set.

Operate the shift lever with the brake pedal depressed.



### ■ Parking brake operation

- When the engine switch is not in IGNITION ON mode, the parking brake cannot be released using the parking brake switch.
- When the engine switch is not in IGNITION ON mode, automatic mode (automatic brake setting and releasing) is not available.
- If the parking brake is operated repeatedly over a short period of time, the system may restrict operation to prevent overheating. If this happens, refrain from operating the parking brake. Normal operation will return after about 1 minute.

### ■ Parking brake operation sound

When the parking brake operates, a motor sound (whirring sound) may be heard. This does not indicate a malfunction.

### ■ Parking brake indicator light

- Depending on the engine switch mode, the parking brake indicator light will come on and stay on as described below:

IGNITION ON mode: Comes on until the parking brake is released.

Not in IGNITION ON mode: Stays on for approximately 15 seconds.

- When the engine switch is turned off with the parking brake set, the parking brake indicator light will stay on for about 15 seconds. This does not indicate a malfunction.

**■ When there is a malfunction in the system**

Warning lights and/or warning message will turn on or flash. (→P. 688, 701)  
Depending on the condition, the parking brake indicator light may flash.

**■ Usage in winter time**

→P. 299

 NOTICE**■ When parking the vehicle**

Before you leave the vehicle, set the parking brake, shift the shift lever to P and make sure that the vehicle does not move.

**■ When the system malfunctions**

Stop the vehicle in a safe place and check the warning messages.

**■ When the parking brake cannot be released due to a malfunction**

Use the parking brake release tool to manually release the parking brake.  
(→P. 738)

Driving the vehicle with the parking brake set will lead to brake components overheating, which may affect braking performance and increase brake wear.

تلفن شبانه روزی: ۰۲۱-۸۸۶۲۰۸۵

FarmaSOS.com

## Horn

To sound the horn, press on or close to the  mark.

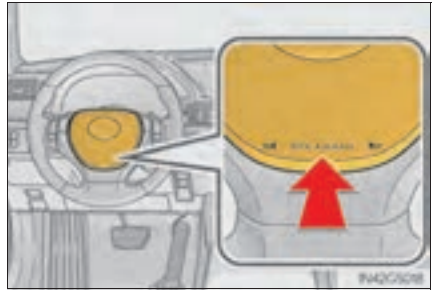

امداد خودرو فارما

تلفن شبانه روزی: ۰۲۱-۸۸۸۶۲۰۸۵



[FarmaSOS.com](http://FarmaSOS.com)

## Headlight switch

The headlights can be operated manually or automatically.

### Operating instructions

Turning the end of the lever turns on the lights as follows:

- ①  The side marker, parking, tail, license plate and instrument panel lights turn on.
- ②  The headlights and all lights listed above turn on.
- ③ **AUTO** The headlights, daytime running lights and all the lights listed above turn on and off automatically. (When the engine switch is in IGNITION ON mode.)
- ④ **DRL OFF**  
(U.S.A.)
  - The daytime running lights (Canada) turn on.

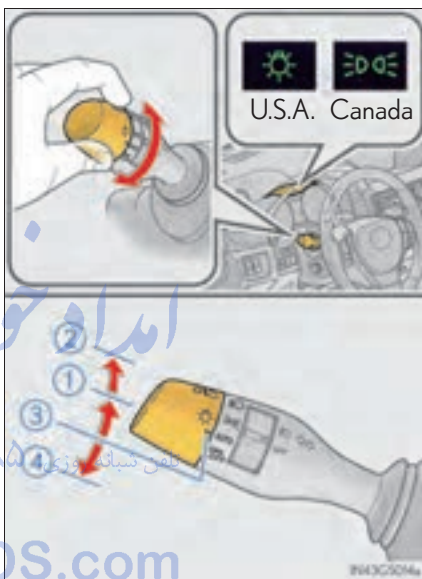

### Turning on the high beam headlights

- ① With the headlights on, push the lever away from you to turn on the high beams.

Pull the lever toward you to the center position to turn the high beams off.

- ② Pull the lever toward you and release it to flash the high beams once.

You can flash the high beams with the headlights on or off.

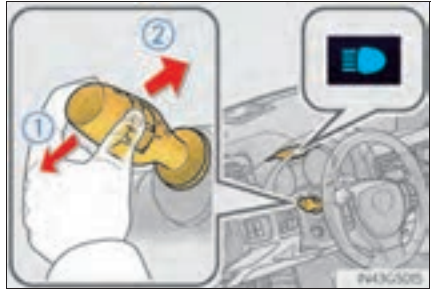

امداد خودرو فارما

تلفن شبانه روزی: ۰۲۱-۸۸۶۲۰۸۵

FarmaSOS.com

### AFS (Adaptive Front-lighting System) (if equipped)

AFS (Adaptive Front-lighting System) secures excellent visibility at intersections and on curves by automatically adjusting the direction of the light axis of the headlights according to vehicle speed and the degree of the tire's angle as controlled by steering input.

AFS operates at speeds of 6 mph (10 km/h) or higher.

#### ■ Deactivating AFS

Turn on the AFS OFF switch.

The indicator turns on when the AFS is deactivated.



امداد خودرو فارما

تلفن: ۰۲۱-۸۸۶۲۰۸۵

FarmaSOS.com

INACSON

### ■ Daytime running light system

- To make your vehicle more visible to other drivers, the parking lights turn on automatically (at an increased intensity) whenever the engine is started and the parking brake is released. Daytime running lights are not designed for use at night.
- Compared to turning on the headlights, the daytime running light system offers greater durability and consumes less electricity, so it can help improve fuel economy.

### ■ Headlight control sensor



The sensor may not function properly if an object is placed on the sensor, or anything that blocks the sensor is affixed to the windshield.

Doing so interferes with the sensor detecting the level of ambient light and may cause the automatic headlight system to malfunction.



### ■ Automatic light off system

When the light switch is in **auto**: The headlights and tail lights turn off 30 seconds after the engine switch is turned to **ACCESSORY** mode or turned off and a door is opened and all of the doors and trunk are closed. (The lights turn off immediately if  on the key is pressed twice after all the doors are closed.)

To turn the lights on again, turn the engine switch to **IGNITION ON** mode, or turn the light switch off once and then back to  or .

If any of the doors or trunk lid is kept open, the lights automatically turn off after 20 minutes.

### ■ Light reminder buzzer

A buzzer sounds when the engine switch is turned off or turned to **ACCESSORY** mode and the driver's door is opened while the lights are turned on.

### ■ Automatic headlight leveling system

The level of the headlights is automatically adjusted according to the number of passengers and the loading condition of the vehicle to ensure that the headlights do not interfere with other road users.

**■ If the “AFS OFF” indicator flashes**

It may indicate a malfunction in the system. Contact your Lexus dealer.

**■ Customization**

Settings (e.g. light sensor sensitivity) can be changed.  
(Customizable features: →P. 777)

**NOTICE****■ To prevent battery discharge**

Do not leave the lights on longer than necessary when the engine is not running.

امداد خودرو فارما

تلفن شبانه روزی: ۰۲۱-۸۸۶۲۰۸۵

FarmaSOS.com



## Fog light switch\*

The fog lights secure excellent visibility in difficult driving conditions, such as in rain and fog.

- ① OFF (U.S.A.) or ○ (Canada)  
Turns the front fog lights off
- ②  $\#D$  Turns the front fog lights on

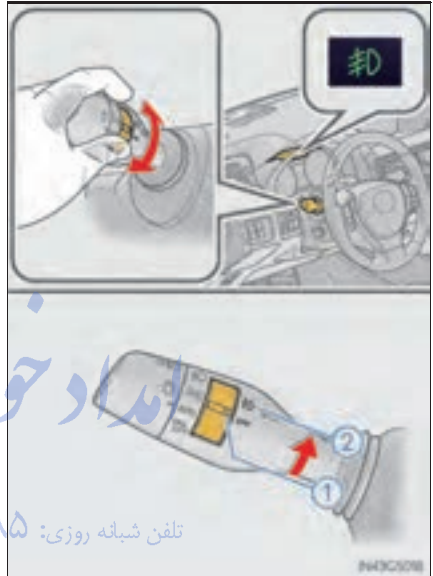

مداد خودرو فارما

تلفن شبانه روزی: ۰۲۱-۸۸۶۲۰۸۵

FarmaSOS.com

- Fog lights can be used when  
The headlights are on in low beam.

## Windshield wipers and washer

### Operating the wiper lever

Operate the lever as follows to operate the wipers. The lever will return to its original position after operation.

► Intermittent windshield wipers with interval adjuster

① **⏏** OFF (U.S.A.) or **○** (Canada)

Up 2 levels

② **△** Up 1 level

③ **▼** (U.S.A.) or **▽** (Canada)

Down 1 level

④ **⏏** HI (U.S.A.) or **⏏** (Canada)

Down 2 levels

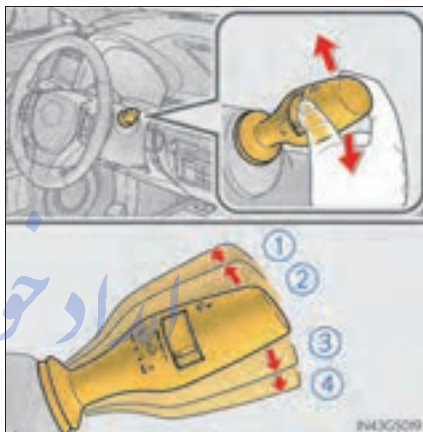

تلفن شبانه روزی: ۰۲۱-۸۸۶۲۰۸۵

Operation Status before operation	<b>⏏</b> OFF or <b>○</b>	<b>△</b>	<b>▼</b> or <b>▽</b>	<b>⏏</b> HI or <b>⏏</b>
Off	Temporary operation	Temporary operation	Intermittent operation	High speed operation
Intermittent operation	Off	Off	Low speed operation	High speed operation
Low speed operation	Off	Intermittent operation	High speed operation	High speed operation
High speed operation	Off	Low speed operation	No change	No change

Wiper intervals can be adjusted when intermittent operation is selected.

- ⑤ Increases the intermittent windshield wiper frequency
- ⑥ Decreases the intermittent windshield wiper frequency

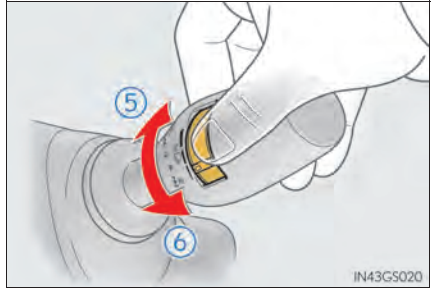

- ⑦ Washer/wiper dual operation  
Wipers will automatically operate a couple of times after the washer squirts.

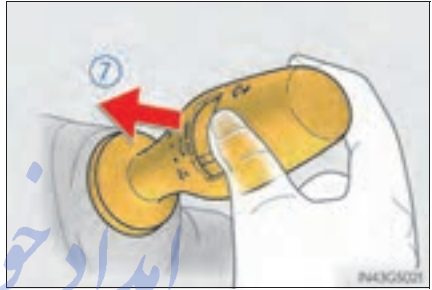

امداد خودرو فارما



تلفن شبانه روزی: ۰۲۱-۸۸۶۲۰۸۵



FarmaSOS.com

## ▶ Rain-sensing windshield wipers

①  OFF (U.S.A.) or  (Canada)  
Up 2 levels

②  Up 1 level

③  (U.S.A.) or  (Canada)  
Down 1 level

④  HI (U.S.A.) or  (Canada)  
Down 2 levels

⑤  AUTO AUTO mode on/off switch





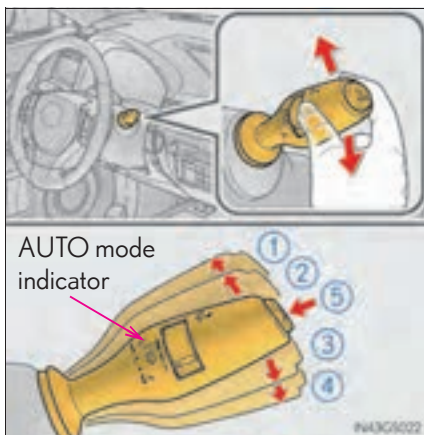

With AUTO mode selected, the wipers will operate automatically when the sensor detects falling rain. The system automatically adjusts wiper timing in accordance with rain volume and vehicle speed.

AUTO mode indicator will turn on when AUTO mode is selected.



تلفن شبانه روزی: ۰۲۱-۸۸۶۲۰۸۵

FarmaSOS.com

Operation Status before operation		 OFF or 		 or 	 HI or 
		Off	Temporary operation	Temporary operation	Low speed operation
Low speed operation	Off	Off	High speed operation	High speed operation	
High speed operation	Off	Low speed operation	No change	No change	
AUTO mode	Intermittent operation	Off	Temporary operation*	Low speed operation	High speed operation
	Continuously		No change		

\*: After temporary operation, the mode will return to AUTO mode.

When AUTO mode is selected, the sensor sensitivity can be adjusted by turning the switch ring.

- ⑥ Increases the sensitivity
- ⑦ Decreases the sensitivity

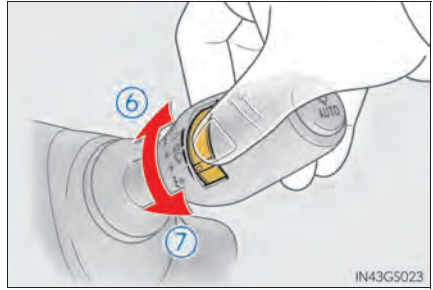

- ⑧ Washer/wiper dual operation

Wipers will automatically operate a couple of times after the washer squirts.

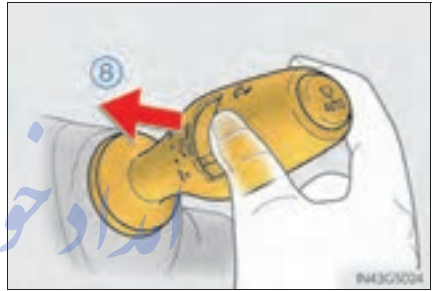

بزرگ خودرو فارما

تلفن شبانه روزی: ۰۲۱-۸۸۶۲۰۸۵

FarmaSOS.com

## Switching between the intermittent windshield wipers and rain-sensing windshield wipers (vehicles with rain-sensing windshield wipers)

The wipers can be used as intermittent windshield wipers, which operate regardless of vehicle speed or amount of raindrops.

Press and hold  AUTO until the AUTO mode indicator stops flashing.

If  AUTO is pressed and held until the AUTO mode indicator stops flashing again, it will return to its previous state. The wiper can be switched when the vehicle is stopped and the wiper is off.

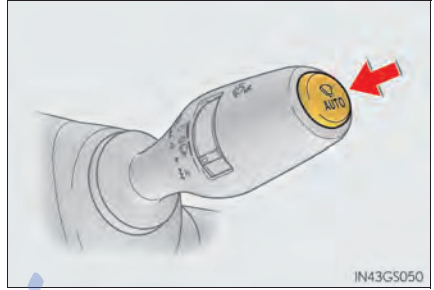

### ■ The windshield wiper and washer can be operated when

The engine switch is in IGNITION ON mode.

### ■ Dripping prevention wiper sweep

After washing and wiping operation several times, the wipers operate one more time after a short delay to prevent dripping.

However, the last sweep will not happen if the vehicle is traveling above 106 mph (170 km/h).

### ■ Effects of vehicle speed on wiper operation

Vehicle speed affects the following even when the wipers are not in AUTO mode.

- Intermittent wiper interval
- Wiper operation when the washer is being used (delay until drip prevention wiper sweep occurs)

With low speed windshield wiper operation selected, wiper operation will be switched from low speed to intermittent wiper operation only when the vehicle is stationary.

### ■ Raindrop sensor (vehicles with rain-sensing windshield wipers)

- The raindrop sensor judges the amount of raindrops.

An optical sensor is adopted. It may not operate properly when sunlight from the rising or setting of the sun intermittently strikes the windshield, or if bugs etc. are present on the windshield.



- If the wiper is turned to AUTO mode while the engine switch is in IGNITION ON mode, the wipers will operate once to show that AUTO mode is activated.
- If the temperature of the raindrop sensor is 185°F (85°C) or higher, or -22°F (-30°C) or lower, automatic operation may not occur. In this case, operate the wipers in any mode other than AUTO mode.

### ■ When the windshield wipers are in temporary operation

AUTO mode cannot be activated even if  is pressed.

### ■ If no windshield washer fluid sprays

Check that the washer nozzles are not blocked if there is washer fluid in the windshield washer fluid reservoir.

### ▲ CAUTION

تلفن شبانه روزی: ۰۲۱-۸۸۶۲۰۸۵

#### ■ Caution regarding the use of windshield wipers in AUTO mode

The windshield wipers may operate unexpectedly if the sensor is touched or the windshield is subject to vibration in AUTO mode. Take care that your fingers or anything else do not become caught in the windshield wipers.

#### ■ Caution regarding the use of washer fluid

When it is cold, do not use the washer fluid until the windshield becomes warm. The fluid may freeze on the windshield and cause low visibility. This may lead to an accident, resulting in death or serious injury.

 NOTICE**■ When the windshield is dry**

Do not use the wipers, as they may damage the windshield.

**■ When there is no washer fluid spray from the nozzle**

Damage to the washer fluid pump may be caused if the lever is pulled toward you and held continually.

**■ When a nozzle becomes blocked**

In this case, contact your Lexus dealer.

Do not try to clear it with a pin or other object. The nozzle will be damaged.

**■ When standing the windshield wipers up**

Raise the wipers in line with the windshield. (→P. 301)

Failure to do so may result in damage to the wipers and/or the hood.

امداد خودرو فارما

تلفن شبانه روزی: ۰۲۱-۸۸۶۲۰۸۵

FarmaSOS.com



## Headlight cleaner switch\*

Washer fluid can be sprayed on the headlights.

Press the switch to clean the headlights.

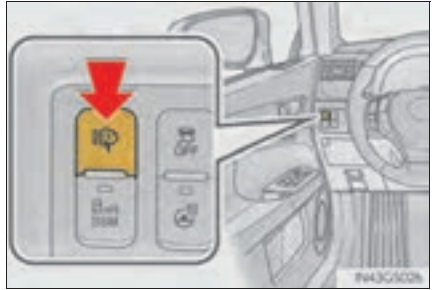

### ■ The headlight cleaners can be operated when

The engine switch is in IGNITION ON mode and the headlight switch is turned on.

### ■ Windshield washer linked operation

When the windshield washer is operated with the engine switch in IGNITION ON mode and the headlights on, the headlight cleaners will operate once. (→P. 196)

تلفن شبانه روزی: ۰۲۱-۸۸۶۲۰۸۵

### ⚠ NOTICE

#### ■ When the washer fluid tank is empty

Do not press the switch continually as the washer fluid pump may overheat.

## Opening the fuel tank cap

Perform the following steps to open the fuel tank cap:

### Before refueling the vehicle

- Close all the doors and windows, and turn the engine switch off.
- Confirm the type of fuel.

---

#### ■ Fuel types

Use premium unleaded gasoline (Octane rating 91 [Research Octane Number 96] or higher)

امداد خودرو فارما

تلفن شبانه روزی: ۰۲۱-۸۸۶۲۰۸۵

FarmaSOS.com

 CAUTION

**■ When refueling the vehicle**

Observe the following precautions while refueling the vehicle. Failure to do so may result in death or serious injury.

- After exiting the vehicle and before opening the fuel door, touch an unpainted metal surface to discharge any static electricity. It is important to discharge static electricity before refueling because sparks resulting from static electricity can cause fuel vapors to ignite while refueling.
- Always hold the grips on the fuel tank cap and turn it slowly to remove it. A whooshing sound may be heard when the fuel tank cap is loosened. Wait until the sound cannot be heard before fully removing the cap. In hot weather, pressurized fuel may spray out the filler neck and cause injury.
- Do not allow anyone that has not discharged static electricity from their body to come close to an open fuel tank.
- Do not inhale vaporized fuel.  
Fuel contains substances that are harmful if inhaled.
- Do not smoke while refueling the vehicle.  
Doing so may cause the fuel to ignite and cause a fire.
- Do not return to the vehicle or touch any person or object that is statically charged.  
This may cause static electricity to build up, resulting in a possible ignition hazard.

**■ When refueling**

Observe the following precautions to prevent fuel overflowing from the fuel tank:

- Securely insert the fuel nozzle into the fuel filler neck.
- Stop filling the tank after the fuel nozzle automatically clicks off.
- Do not top off the fuel tank.

 NOTICE

**■ Refueling**

Do not spill fuel during refueling.

Doing so may damage the vehicle, such as causing the emission control system to operate abnormally or damaging fuel system components or the vehicle's painted surface.

## Opening the fuel tank cap

- 1 With the doors unlocked, press the center of the rear edge of the fuel filler door.

Push until you hear a click and take your hand away to slightly open the fuel filler door. Then open the door fully by hand.

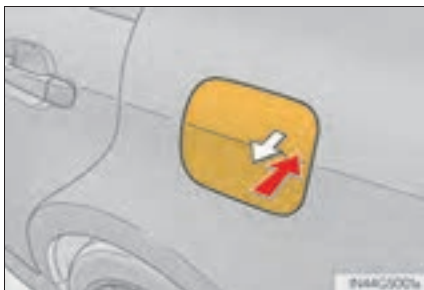

- 2 Turn the fuel tank cap slowly to open.

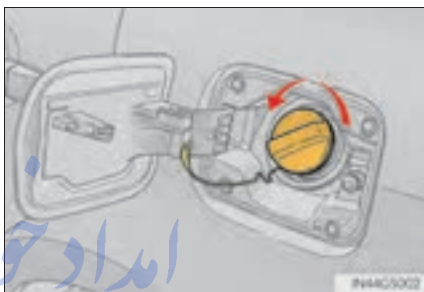

- 3 Hang the fuel tank cap on the back of the fuel filler door.

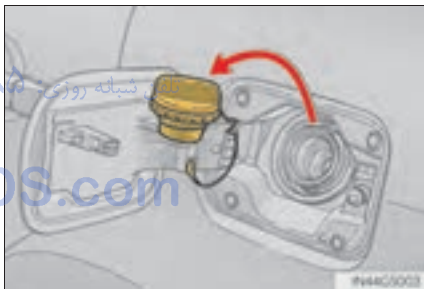

امداد خودرو فارما

شبهه روزی - ۰۲۱-۸۸۶۲۰۸۰۸

FarmaSOS.com

**■ If the fuel filler door cannot be opened**

Remove the cover inside the trunk and pull the lever to open the fuel filler door if the fuel filler door cannot be opened pressing the rearward of the fuel filler door.

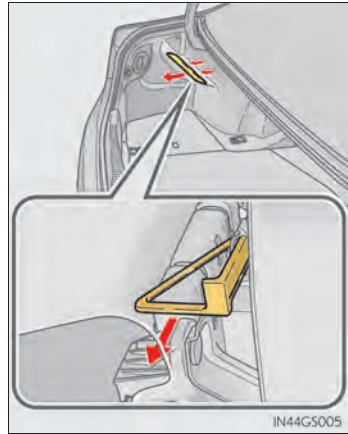

# امداد خودرو فارما

تلفن شبانه روزی: ۰۲۱-۸۸۸۶۲۰۸۵

[FarmaSOS.com](http://FarmaSOS.com)

## Closing the fuel tank cap

- 1 After refueling, turn the fuel tank cap until you hear a click. Once the cap is released, it will turn slightly in the opposite direction.

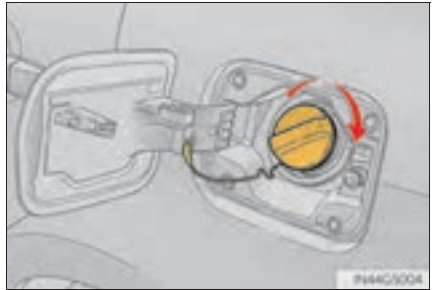

- 2 Close the fuel filler door, and press the center of the rear edge of the fuel filler door until you hear a click.

When you lock the doors, the fuel filler door will lock also.



### Fuel filler door lock condition

The fuel filler door may not be locked even when the vehicle's doors are locked in the following conditions:

- When operating the door lock button inside the vehicle
- When the automatic door locking system is operated (→P. 780)
- When the fuel filler door is closed after the vehicle's doors are locked

### CAUTION

#### When replacing the fuel tank cap

Do not use anything but a genuine Lexus fuel tank cap designed for your vehicle. Doing so may cause a fire or other incident which may result in death or serious injury.

## Cruise control\*

### Summary of functions

Use the cruise control to maintain a set speed without depressing the accelerator pedal.

- ① Indicators
- ② Cruise control switch



### Setting the vehicle speed

- 1 Press the "ON-OFF" button to activate the cruise control.

Cruise control indicator will come on.

Press the button again to deactivate the cruise control.



- 2 Accelerate or decelerate the vehicle to the desired speed, and push the lever down to set the speed.

"SET" indicator will come on.

The vehicle speed at the moment the lever is released becomes the set speed.



## Adjusting the set speed

To change the set speed, operate the lever until the desired set speed is obtained.

- ① Increases the speed
- ② Decreases the speed

Fine adjustment: Momentarily move the lever in the desired direction.

Large adjustment: Hold the lever in the desired direction.



The set speed will be increased or decreased as follows:

Fine adjustment: By approximately 1 mph (1.6 km/h) each time the lever is operated.

Large adjustment: The set speed can be increased or decreased continually until the lever is released.

## Canceling and resuming the constant speed control

- ① Pulling the lever toward you cancels the constant speed control.

The speed setting is also canceled when the brakes are applied.

- ② Pushing the lever up resumes the constant speed control.

Resuming is available when the vehicle speed is more than approximately 25 mph (40 km/h).





### ■ Cruise control can be set when

- The shift lever is in D.
- Range 4 or higher of D has been selected by using the paddle shift.
- Vehicle speed is above approximately 25 mph (40 km/h).

### ■ Accelerating after setting the vehicle speed

- The vehicle can be accelerated normally. After acceleration, the set speed resumes.
- Even without canceling the cruise control, the set speed can be increased by first accelerating the vehicle to the desired speed and then pushing the lever down to set the new speed.

### ■ Automatic cruise control cancelation

Cruise control will stop maintaining the vehicle speed in any of the following situations.

- Actual vehicle speed falls more than approximately 10 mph (16 km/h) below the preset vehicle speed.  
At this time, the memorized set speed is not retained.
- Actual vehicle speed is below approximately 25 mph (40 km/h).
- VSC is activated.
- TRAC is activated for a period of time.
- When the VSC or TRAC system is turned off by pressing the VSC OFF switch.

### ■ If the warning message for the cruise control is shown on the multi-information display

Press the "ON-OFF" button once to deactivate the system, and then press the button again to reactivate the system.

If the cruise control speed cannot be set or if the cruise control cancels immediately after being activated, there may be a malfunction in the cruise control system. Have the vehicle inspected by your Lexus dealer.

**⚠ CAUTION****■ To avoid operating the cruise control by mistake**

Switch the cruise control off using the “ON-OFF” button when not in use.

**■ Situations unsuitable for cruise control**

Do not use cruise control in any of the following situations.

Doing so may result in loss of control and could cause an accident resulting in death or serious injury.

- In heavy traffic
- On roads with sharp bends
- On winding roads
- On slippery roads, such as those covered with rain, ice or snow
- On steep hills  
Vehicle speed may exceed the set speed when driving down a steep hill.
- During emergency towing

امداد خودرو فارما

تلفن شبانه روزی: ۰۲۱-۸۸۶۲۰۸۵

FarmaSOS.com

## Dynamic radar cruise control\*

### Summary of functions

Dynamic radar cruise control supplements conventional cruise control with a vehicle-to-vehicle distance control. In vehicle-to-vehicle distance control mode, the vehicle automatically accelerates or decelerates in order to maintain a set following distance from vehicles ahead.

- ① Vehicle-to-vehicle distance button
- ② Display
- ③ Set speed
- ④ Indicators
- ⑤ Cruise control switch



FarmaSOS.com

## Setting the vehicle speed (vehicle-to-vehicle distance control mode)

- 1 Press the “ON-OFF” button to activate the cruise control.

Radar cruise control indicator will come on.

Press the button again to deactivate the cruise control.



- 2 Accelerate or decelerate the vehicle to the desired speed, and push the lever down to set the speed.

“SET” indicator will be displayed.

The vehicle speed at the moment the lever is released becomes the set speed.



تلفن شبانه روزی: ۰۲۱-۸۸۶۲۰۸۵

FarmaSOS.com

## Adjusting the set speed

To change the set speed, operate the lever until the desired set speed is displayed.

- ① Increases the speed
- ② Decreases the speed

Fine adjustment: Momentarily move the lever in the desired direction.

Large adjustment: Hold the lever in the desired direction.



In the vehicle-to-vehicle distance control mode, the set speed will be increased or decreased as follows:

- When the set speed is shown in "MPH"

Fine adjustment: By approximately 1 mph (1.6 km/h) each time the lever is operated

Large adjustment: By approximately 5 mph (8 km/h) for each 0.75 seconds the lever is held

- When the set speed is shown in "km/h": تلفن شبانه روزی: ۰۲۱۴۱۱۱۱۱۱

Fine adjustment: By approximately 0.6 mph (1 km/h) each time the lever is operated

Large adjustment: By approximately 3.1 mph (5 km/h) for each 0.75 seconds the lever is held

In the constant speed control mode (→P. 220), the set speed will be increased or decreased as follows:

Fine adjustment: By approximately 1 mph (1.6 km/h) each time the lever is operated

Large adjustment: The set speed can be increased or decreased continually until the lever is released.

## Changing the vehicle-to-vehicle distance

Pressing the button changes the vehicle-to-vehicle distance as follows:

- ① Long
- ② Medium
- ③ Short

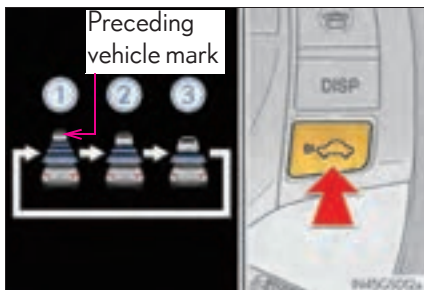

The vehicle-to-vehicle distance is set automatically to long mode when the engine switch is turned to IGNITION ON mode.

If a vehicle is running ahead of you, the preceding vehicle mark will also be displayed.

## Vehicle-to-vehicle distance settings

Select a distance from the table below. Note that the distances shown correspond to a vehicle speed of 50 mph (80 km/h). Vehicle-to-vehicle distance increases/decreases in accordance with vehicle speed.

Distance options	Vehicle-to-vehicle distance
Long	Approximately 160 ft. (50 m)
Medium	Approximately 130 ft. (40 m)
Short	Approximately 100 ft. (30 m)

## Canceling and resuming the speed control

- ① Pulling the lever toward you cancels the cruise control.

The speed setting is also canceled when the brakes are applied.

- ② Pushing the lever up resumes the cruise control and returns vehicle speed to the set speed.

Resuming is available when the vehicle speed is more than approximately 25 mph (40 km/h).

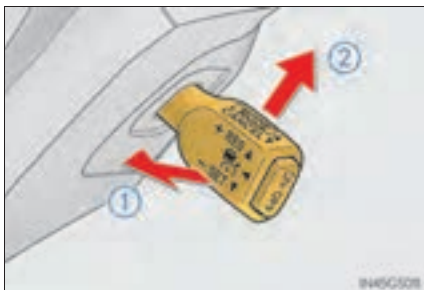

امداد خودرو فارما

تلفن شبانه روزی: ۰۲۱-۸۸۶۲۰۸۵

FarmaSOS.com

## Driving in vehicle-to-vehicle distance control mode

This mode employs a radar sensor to detect the presence of vehicles up to approximately 400 ft. (120 m) ahead, determines the current vehicle-to-vehicle following distance, and operates to maintain a suitable following distance from the vehicle ahead.

Note that vehicle-to-vehicle distance will close in when traveling on long downhill slopes.

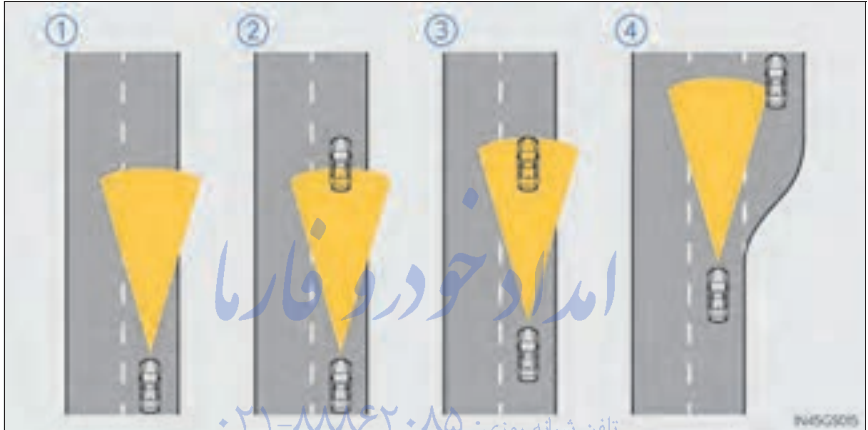

### ① Example of constant speed cruising

When there are no vehicles ahead

The vehicle travels at the speed set by the driver. The desired vehicle-to-vehicle distance can also be set by operating the vehicle-to-vehicle distance control.

### ② Example of deceleration cruising

When the vehicle ahead is driving slower than the set speed

When a vehicle is detected running ahead of you, the system automatically decelerates your vehicle. When a greater reduction in vehicle speed is necessary, the system applies the brakes. A warning tone warns you when the system cannot decelerate sufficiently to prevent your vehicle from closing in on the vehicle ahead.



### ③ Example of follow-up cruising

When following a vehicle driving slower than the set speed

The system continues follow-up cruising while adjusting for changes in the speed of the vehicle ahead in order to maintain the vehicle-to-vehicle distance set by the driver.

### ④ Example of acceleration

When there are no longer any vehicles ahead driving slower than the set speed

The system accelerates until the set speed is reached. The system then returns to constant speed cruising.

## Approach warning

When your vehicle is too close to a vehicle ahead, and sufficient automatic deceleration via the cruise control is not possible, the display will flash and the buzzer will sound to alert the driver. An example of this would be if another driver cuts in front of you while you are following a vehicle. Apply the brakes to ensure an appropriate vehicle-to-vehicle distance.

### ■ Warnings may not occur when

In the following instances, there is a possibility that the warnings will not occur:

- When the speed of the vehicle ahead matches or exceeds your vehicle speed
- When the vehicle ahead is traveling at an extremely slow speed
- Immediately after the cruise control speed was set
- At the instant the accelerator is applied

تلفن شبانه روزی: ۰۲۱-۸۸۶۲۰۸۵

FarmasOS.com

## Selecting conventional constant speed control mode

When constant speed control mode is selected, your vehicle will maintain a set speed without controlling the vehicle-to-vehicle distance. Select this mode only when vehicle-to-vehicle distance control mode does not function correctly due to dirt etc.

- ① Press the "ON-OFF" button to activate the cruise control.

Press the button again to deactivate the cruise control.

- ② Switch to constant speed control mode.

(Push the lever forward and hold for approximately one second.)

Constant speed control mode indicator will come on.

When in constant speed control mode, to return to vehicle-to-vehicle distance control mode, push the lever forward again and hold for approximately 1 second.

After the desired speed has been set, it is not possible to return to vehicle-to-vehicle distance control mode.

If the engine switch is turned off and then turned to IGNITION ON mode again, the vehicle will automatically return to vehicle-to-vehicle distance control mode.

Adjusting the speed setting:

→P. 210

Canceling and resuming the speed setting: →P. 210



امداد خودرو فارما

تلفن شبانه روزی: ۰۲۱-۸۸۶۳۰۸۵

FarmaSOS.com

### ■ Dynamic radar cruise control can be set when

- The shift lever is in D.
- Range 4 or higher of D has been selected by using the paddle shift.
- Vehicle speed is above approximately 30 mph (50 km/h).

### ■ Accelerating after setting the vehicle speed

The vehicle can accelerate normally. After acceleration, the set speed resumes. However, during vehicle-to-vehicle distance control mode, the vehicle speed may decrease below the set speed in order to maintain the distance to the vehicle ahead.

### ■ Automatic cancelation of vehicle-to-vehicle distance control

Vehicle-to-vehicle distance control driving is automatically canceled in the following situations:

- Actual vehicle speed falls below approximately 25 mph (40 km/h).
- VSC is activated.
- TRAC is activated for a period of time.
- When the VSC or TRAC system is turned off by pressing the VSC OFF switch.
- The sensor cannot operate correctly because it is covered in some way.
- The windshield wipers are operating at high speed (when the wipers are in AUTO mode or the high speed wiper operation).
- When snow mode is set.

If vehicle-to-vehicle distance control driving is automatically canceled for any other reason, there may be a malfunction in the system. Contact your Lexus dealer.

تلفن شبانه روزی: ۰۸۵-۸۸۶۲۰۲۱

FarmasOS.com

### ■ Automatic cancelation of constant speed control

The cruise control will stop maintaining the vehicle speed in the following situations:

- Actual vehicle speed is more than approximately 10 mph (16 km/h) below the set vehicle speed.  
At this time, the memorized set speed is not retained.
- Vehicle speed falls below approximately 25 mph (40 km/h).
- VSC is activated.
- TRAC is activated for a period of time.
- When the VSC or TRAC system is turned off by pressing the VSC OFF switch.

### ■ When the LKA (Lane-Keeping Assist) will be activated

Using the radar cruise control in vehicle-to-vehicle distance control mode, lane keeping assistance control is activated.

### ■ Radar sensor and grille cover

Always keep the sensor and grille cover clean to ensure that the vehicle-to-vehicle distance control operates properly. (Some obstructions, such as snow, ice and plastic objects, cannot be detected by the obstruction sensor.)

Dynamic radar cruise control is canceled if an obstruction is detected.

- ① Grille cover
- ② Radar sensor

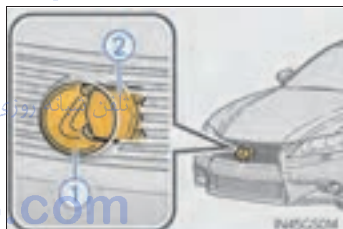

### ■ Warning messages and buzzers for dynamic radar cruise control

Warning messages and buzzers are used to indicate a system malfunction or to inform the driver of the need for caution while driving. (→P. 700)

## ■ Certification

- ▶ For vehicles sold in the U.S.A.

FCC ID: HYQDNMWR004

This device complies with Part 15 of the FCC Rules. Operation is subject to the following two conditions: (1) this device may not cause harmful interference, and (2) this device must accept any interference received, including interference that may cause undesired operation.

### FCC WARNING

Changes or modifications not expressly approved by the party responsible for compliance could void the user's authority to operate the equipment.

Radio frequency radiation exposure Information:

This equipment complies with FCC radiation exposure limits set forth for an uncontrolled environment.

This equipment should be installed and operated with minimum distance of 20 cm between the radiator and your body.

This transmitter must not be co-located or operating in conjunction with any other antenna or transmitter.

- ▶ For vehicles sold in Canada

Operation is subject to the following two conditions: (1) this device may not cause interference, and (2) this device must accept any interference, including interference that may cause undesired operation of the device.

FarmaSOS.com

**⚠ CAUTION****■ Before using dynamic radar cruise control**

Do not overly rely on vehicle-to-vehicle distance control.

Be aware of the set speed. If automatic deceleration/acceleration is not appropriate, adjust the vehicle speed, as well as the distance between your vehicle and vehicles ahead by applying the brakes etc.

**■ Cautions regarding the driving assist systems**

Observe the following precautions.

Failure to do so may cause an accident resulting in death or serious injury.

**● Assisting the driver to measure following distance**

The dynamic radar cruise control is only intended to help the driver in determining the following distance between the driver's own vehicle and a designated vehicle traveling ahead. It is not a mechanism that allows careless or inattentive driving, and it is not a system that can assist the driver in low-visibility conditions. It is still necessary for driver to pay close attention to the vehicle's surroundings.

**● Assisting the driver to judge proper following distance**

The dynamic radar cruise control determines whether the following distance between the driver's own vehicle and a designated vehicle traveling ahead is appropriate or not. It is not capable of making any other type of judgement. Therefore, it is absolutely necessary for the driver to remain vigilant and to determine whether or not there is a possibility of danger in any given situation.

**● Assisting the driver to operate the vehicle**

The dynamic radar cruise control has no capability to prevent or avoid a collision with a vehicle traveling ahead. Therefore, if there is ever any danger, the driver must take immediate and direct control of the vehicle and act appropriately in order to ensure the safety of all involved.

 CAUTION

**■ To avoid inadvertent cruise control activation**

Switch the cruise control off using the “ON-OFF” button when not in use.

**■ Situations unsuitable for dynamic radar cruise control**

Do not use dynamic radar cruise control in any of the following situations. Doing so may result in inappropriate speed control and could cause an accident resulting in death or serious injury.

- In heavy traffic
- On roads with sharp bends
- On winding roads
- On slippery roads, such as those covered with rain, ice or snow
- On steep downhills, or where there are sudden changes between sharp up and down gradients  
Vehicle speed may exceed the set speed when driving down a steep hill.
- At entrances to expressways
- When weather conditions are bad enough that they may prevent the sensors from functioning correctly (fog, snow, sandstorm, heavy rain, etc.)
- When an approach warning buzzer is heard often
- During emergency towing

**⚠ CAUTION****■ When the sensor may not be correctly detecting the vehicle ahead**

Apply the brakes as necessary when any of the following types of vehicles are in front of you.

As the sensor may not be able to correctly detect these types of vehicles, the approach warning (→P. 219) will not be activated, and a fatal or serious accident may result.

- Vehicles that cut in suddenly
- Vehicles traveling at low speeds
- Vehicles that are not moving
- Vehicles with small rear ends (trailers with no load on board etc.)
- Motorcycles traveling in the same lane

**■ Conditions under which the vehicle-to-vehicle distance control may not function correctly**

Apply the brakes as necessary in the following conditions as the radar sensor may not be able to correctly detect vehicles ahead, and a fatal or serious accident may result:

- When water or snow thrown up by the surrounding vehicles hinders the functioning of the sensor
- When your vehicle is pointing upwards (caused by a heavy load in the trunk etc.)
- When the road curves or when the lanes are narrow
- When steering wheel operation or your position in the lane is unstable
- When the vehicle ahead of you decelerates suddenly



**⚠ CAUTION****■ Handling the radar sensor**

Observe the following to ensure the cruise control system can function effectively. Otherwise, the system may not function correctly and could result in an accident.

- Keep the sensor and grille cover clean at all times.  
Clean the sensor and grille cover with a soft cloth so you do not mark or damage them.
- Do not subject the sensor or surrounding area to a strong impact.  
If the sensor moves even slightly off position, the system may malfunction. If the sensor or surrounding area is subject to a strong impact, always have the area inspected and adjusted by a Lexus dealer.
- Do not disassemble the sensor.
- Do not attach accessories or stickers to the sensor, grille cover or surrounding area.
- Do not modify or paint the sensor and grille cover.
- Do not replace them with non-genuine parts.

تلفن شبانه روزی: ۰۲۱-۸۸۶۲۰۸۵

FarmaSOS.com

## LKA (Lane-Keeping Assist)\*

### Summary of functions

While driving on a freeway or motor highway that has lane markers and no sharp curves, the system recognizes the lanes using a camera located above the inside rear view mirror as a sensor to assist the driver with staying in the lane. The LKA system has two functions.

Camera sensor

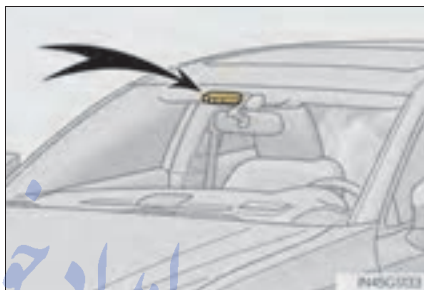

امداد خودرو فارما

تلفن شبانه روزی: ۰۲۱-۸۸۶۲۰۸۵

FarmaSOS.com

## Functions included in the LKA

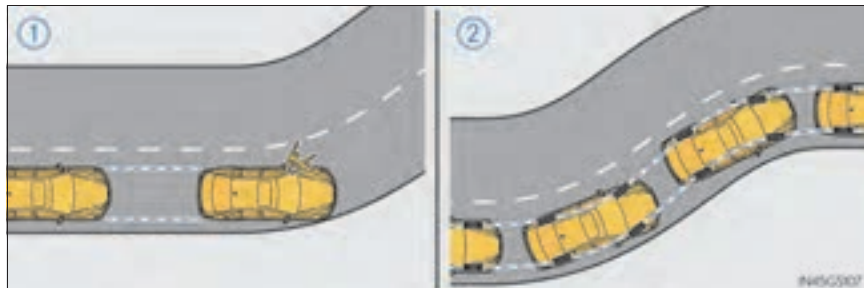

### ① Lane departure warning function

If the system judges that the vehicle may deviate from its lane, it alerts the driver using beeping, screen displays and a sensory warning\* given via the steering wheel.

\*: A slight steering torque is applied for a short period of time in the direction of the center of the lane.

### ② Lane keeping assist function

- This function will be active when the vehicle-to-vehicle distance control mode of the cruise control (→P. 213) is set with vehicle speed above approximately 45 mph (72 km/h) and while the lane departure warning function is active.
- When the lane keeping assist function is active, a slight steering torque will be applied, to help the driver maintain the vehicle inside the lane.

The lane keeping assist function will be temporarily canceled if the steering wheel is not operated, or if you continue driving with your hands lightly touching the steering wheel. (→P. 233)

## Turning the LKA system on

Press the “LKA” switch to activate the system.

“LKA” indicator will come on.

Press the switch again to turn the LKA system off.

The LKA system will revert to off each time the engine switch is turned to IGNITION ON mode.



# امداد خودرو فارما

تلفن شبانه روزی: ۰۲۱-۸۸۶۲۰۸۵

[FarmaSOS.com](http://FarmaSOS.com)

## Operating conditions for each function

### ■ Lane departure warning function

- When the vehicle speed is approximately 30 mph (48 km/h) or more
- When the lane width is more than approximately 9.1 ft. (2.8 m)
- When driving on a straight road or through a curve with a radius of more than approximately 394 ft. (120 m)

### ■ Lane keeping assist function

- When the vehicle speed is between approximately 45 and 112 mph (72 and 180 km/h)
- When the vehicle-to-vehicle distance mode of the radar cruise control is on, and the set vehicle speed is approximately 45 mph (72 km/h) or more (the function will not operate when the radar cruise control is in set speed mode)
- When the lane width is between approximately 9.1 and 13.1 ft. (2.8 and 4.0 m)
- When driving on a straight road or through a curve with a radius of more than approximately 755 ft. (230 m)

تلفن شبانه روزی: ۰۲۱-۸۸۶۲۰۸۵

FarmaSOS.com

## Indication on the multi-information display

When the LKA system is on, the lane line display and steering wheel display are shown.

- ① Lane keeping assist function operation indication

Steering wheel displayed:

Indicates that the function is currently operating. (If the lane departure warning operates at this time, the steering wheel flashes orange.)

Steering wheel not displayed:

Indicates that the function is not currently operating. (When the lane keeping assist function is canceled, the buzzer will beep twice.)

- ② Dynamic radar cruise control display

- ③ Lane departure warning function indication (when the inside of the white line is white):

The function has recognized lane markers. (If the lane departure warning operates at this time, the lines flash orange.)

- ④ Lane departure warning function indication (when the inside of the white line is black):

A lane marker is not recognized by the system, or the LKA system functions are temporarily canceled.

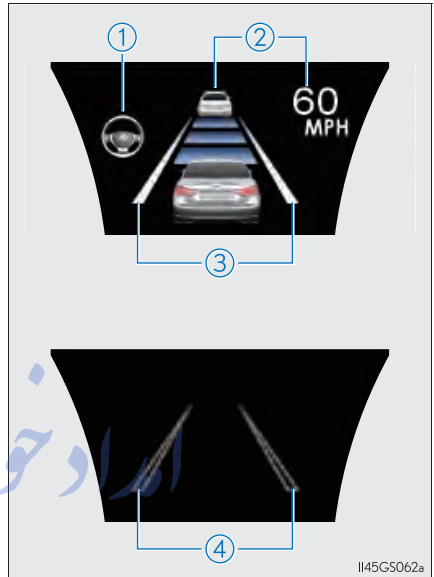

تلفن شبانه روزی: ۰۲۱-۸۵۰۰۰۰۰۰  
FarmaSOS.com

### ■ Temporary cancelation of the LKA system functions

If any of the following occurs, the LKA system functions will be temporarily canceled. The functions will resume after the necessary operating conditions have returned.

- The steering wheel is turned as far as necessary to cause the vehicle to change lanes.
- When the system detects no-handed driving. (The lane keeping assist function will be temporarily canceled, but the lane departure warning function will continue.)
- The turn signal lever is operated.
- The vehicle speed deviates from the operating range of the LKA system functions. (The buzzer will beep twice when the lane keeping assist function is being canceled.)
- When the lane lines cannot be recognized while driving. (The buzzer will beep twice when the lane keeping assist function is being canceled.)
- The wiper switch is set on high speed mode or is set on AUTO mode with wipers operating at high speed. (The lane keeping assist function will be temporarily canceled, but the lane departure warning function will continue.)
- If the vehicle crosses a line for approximately half a minute or more. (The lane keeping assist function will be temporarily canceled, but the lane departure warning function will continue.)
- When the lane departure warning function is activated.  
The lane departure warning function will not operate again for a several seconds after it has been activated, even if the vehicle leaves the lane again.

### ■ The lane departure warning

It may be difficult to feel the sensory warning depending on the road conditions.

### ■ No-handed driving warning

If the steering wheel is not operated for approximately 15 seconds on a straight road or approximately 5 seconds on a curve, the buzzer will beep twice, indicators on the multi-information display will flash, and the lane keeping assist function will be temporarily canceled. If you drive the vehicle with your hands lightly touching the steering wheel, this may also be detected as no-handed driving.

### ■ After the vehicle has been parked in the sun

The LKA system functions may not be available and a warning message (→P. 708) will be displayed for a while after driving has started. In such cases, turn the LKA system off and turn it on again after normal temperature returns. When the temperature in the cabin decreases and the temperature around the camera sensor (→P. 228) becomes suitable for its operation, the functions will begin to operate.

### ■ If there are lane markers on only one side of the vehicle

The lane keeping assist function will not operate. Also, the lane departure warning will not operate for the side on which lane markers could not be recognized.

### ■ Conditions in which the function may not operate correctly

In the following conditions, the LKA system functions may not operate, or it may not be possible to ensure adequate performance. Also, the camera sensor may be unable to recognize lane lines causing the lane departure warning function to operate incorrectly, or the lane keeping assist function may not operate properly. However, this does not indicate a malfunction.

- When driving through an area with no lane markers, such as a tollbooth, a crossing or before a ticket checkpoint
- When driving on a sharp curve
- When lanes are extremely narrow or extremely wide
- When the vehicle leans to one side an unusual amount due to a heavy load or improper tire inflation pressure
- When the following distance between your vehicle and the vehicle ahead is extremely short
- When the lane markers are yellow (These may be more difficult for the system to recognize compared to white markers.)
- When the lane markers are broken, "Botts' dots", "Raised pavement marker" or stones
- When lane markers are obscured or partially obscured by sand, dirt, etc.
- When there are shadows on the road running parallel with lane markers, or if a shadow covers the lane markers
- When driving on a particularly bright road surface, such as concrete
- When driving on a road surface that is bright due to reflected light
- When driving in a location where the light level changes rapidly, such as the entrance to or exit from a tunnel
- When sunlight or the headlights of oncoming vehicles are shining directly into the camera lens
- When driving on roads that are branching or merging
- When driving on a road surface that is wet due to rain, previous rainfall, standing water, etc.
- When the vehicle experiences strong up-and-down motion such as when driving on an extremely rough road or on a seam in the pavement
- When headlight brightness at nighttime is reduced due to dirt on the lenses, or when the headlights are misaligned
- When driving with a strong crosswind



- When driving on winding roads or roads that are uneven
- When driving on rough or unpaved roads

#### ■ When changing the tires

Depending on the tires used, sufficient performance may not be maintainable.

#### ■ Warning messages for LKA

Warning messages are used to indicate a system malfunction or to inform the driver of the need for caution while driving. (→P. 700, 708)

### ⚠ CAUTION

#### ■ Before using the LKA system

Do not rely solely on the LKA system. The LKA system does not drive the vehicle automatically, nor does it reduce the amount of care you need to take. As such, the driver must always assume full responsibility for understanding his/her surroundings, for operating the steering wheel to correct the driving line, and for driving safely.

Inappropriate or negligent driving could lead to an accident.

#### ■ To avoid operating the LKA by mistake

Switch the LKA off using the "LKA" switch when not in use.

#### ■ Situations unsuitable for LKA

Do not use LKA in any of the following situations. تلفن شبانه روزی: ۰۲۱۳۳۴۲۰۸۸  
Otherwise, the system may not function correctly and could result in an accident.

- When driving with snow tires, tire chains, a spare tire, or similar equipment
- When the tires have been excessively worn, or when the tire inflation pressure is low.
- When there are objects or structures along the roadside that might be misinterpreted as lane markers (such as guardrails, curb, reflector posts, etc.)
- When driving on snowy roads
- When pavement lane markers are difficult to see due to rain, snow, fog, etc.
- When there are visible lines on the pavement from road repairs, or if the remains of old lane markers are still visible on the road
- When driving on slippery roads, such as those covered with rain, ice or snow
- When driving in a lane other than the driving or passing lanes on a freeway or highway
- When driving on a road with lane closures due to maintenance, or when driving in a temporary lane
- When emergency towing

 NOTICE

■ **To prevent damage to or incorrect operation of the LKA system**

- Do not modify the headlights or attach stickers to the surface of the lights.
- Do not modify the suspension or sun visor, or replace them with non-genuine parts.
- Do not install or place anything on the hood or the grille. Also, do not install a grille guard (bull bars, kangaroo bar etc.).
- Do not modify the sun visor or replace it with anything other than a genuine Lexus product.
- If your windshield needs repairs, contact your Lexus dealer.

■ **Camera sensor (→P. 228)**

Observe the following to ensure that the LKA system functions correctly.

- Keep the windshield clean at all times.  
Performance could be affected if the windshield is dirty, or if raindrops, condensation or ice are adhering to the windshield.
  - Do not attach a sticker or other items to the windshield near the camera sensor.
  - Do not install or place anything near the camera.
- 
- When adjusting the rear view mirror, make sure that it does not block the camera lens.
  - Do not attach window tinting to the windshield.
  - Do not install an antenna in front of the camera lens.
  - If the windshield is fogged up, use the windshield defogger to remove fog from the windshield.  
When it is cold, using the heater with air blowing to the feet may allow the upper part of the windshield to fog up. This will have a negative effect on the images.

 NOTICE

- Do not place anything on the dashboard.  
The camera sensor may recognize the image reflected on the windshield as lane markers by mistake.
- Do not scratch the camera lens, or let it get dirty.  
When cleaning the inside of the windshield, be careful not to get any glass cleaner etc. on the lens. Also, do not touch the lens.  
For lens repair, contact your Lexus dealer.
- Do not change the installation position or direction of the camera sensor or remove it. The direction of the camera sensor is precisely adjusted.
- Do not subject the camera sensor to strong impact or force, and do not disassemble the camera sensor.

امداد خودرو فارما

تلفن شبانه روزی: ۰۲۱-۸۸۶۲۰۸۵

FarmaSOS.com

## Intuitive parking assist\*

The distance from your vehicle to nearby obstacles when parallel parking or maneuvering into a garage is measured by the sensors and communicated via the multi-information display, Remote Touch screen and a buzzer. Always check the surrounding area when using this system.

### ■ Types of sensors



① Front center sensors

② Front corner sensors

③ Rear corner sensors

④ Rear center sensors

تلفن شبانه روزی: ۰۲۱-۸۸۶۲۰۸۵  
FarmaSOS.com

### ■ Intuitive parking assist switch

Turns the intuitive parking assist on/off

When on, the indicator light comes on and the buzzer sounds to inform the driver that the system is operational.

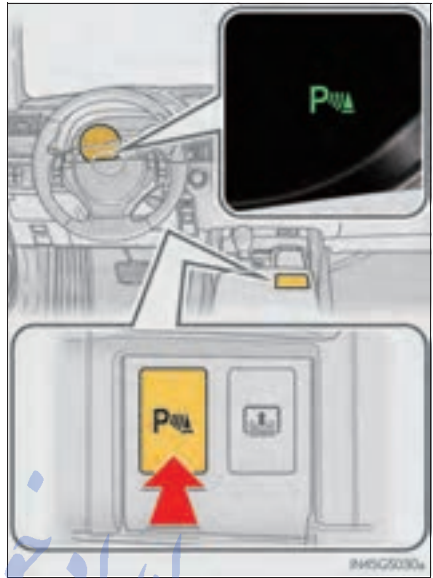

امداد خودرو فارما

تلفن شبانه روزی: ۰۲۱-۸۸۶۲۰۸۵

FarmaSOS.com

## Display

When the sensors detect an obstacle, a graphic is shown on the multi-information display and Remote Touch screen depending on the position and distance to the obstacle.

### ■ Multi-information display

- ① Front corner sensor detection
- ② Front center sensor detection
- ③ Rear corner sensor detection
- ④ Rear center sensor detection

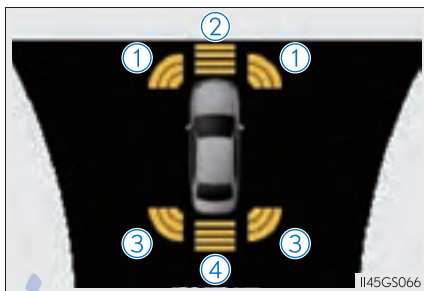

امداد خودرو فارما

تلفن شبانه روزی: ۰۲۱-۸۸۶۲۰۸۵

FarmaSOS.com

## ■ Remote Touch screen

▶ For 8-inch display

- ① When the rear view monitor system is not displayed

A graphic is automatically displayed when an obstacle is detected. The screen can be set so that the graphic is not displayed. (→P.246)

- ② When the rear view monitor system is displayed (insert display)

A simplified image is displayed on the right upper corner of the Remote Touch screen when an obstacle is detected.



▶ For 12.3-inch display

















A graphic will be shown on the side display

A graphic is automatically displayed when an obstacle is detected. The screen can be set so that the graphic is not displayed. (→P.246)













## Sensor detection display, obstacle distance

### ■ Front center sensor

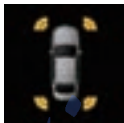



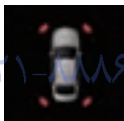
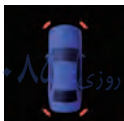





Approximate distance to obstacle	Multi-information display	Remote Touch screen		
		8-inch display	8-inch display (insert display)	12.3-inch display
3.3 ft. (100 cm) to 1.6 ft. (50 cm)	 (continuous)	 (continuous)	 (blinking slowly)	 (continuous)
1.6 ft. (50 cm) to 1.2 ft. (37.5 cm)	 (continuous)	 (continuous)	 (blinking)	 (continuous)
1.2 ft. (37.5 cm) to 1.0 ft. (30 cm)	 (continuous)	 (continuous)	 (blinking rapidly)	 (continuous)
Less than 1.0 ft. (30 cm)	 (blinking)	 (continuous)	 (continuous)	 (continuous)



### ■ Corner sensors

Approximate distance to obstacle	Multi-information display	Remote Touch screen		
		8-inch display	8-inch display (insert display)	12.3-inch display
2.0 ft. (60 cm) to 1.5 ft. (45 cm)	 (continuous)	 (continuous)	 (blinking)	 (continuous)
1.5 ft. (45 cm) to 1.0 ft. (30 cm)	 (continuous)	 (continuous)	 (blinking rapidly)	 (continuous)
Less than 1.0 ft. (30 cm)	 (blinking)	 (continuous)	 (continuous)	 (continuous)

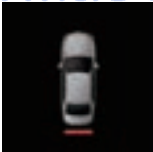
### ■ Rear center sensor

Approximate distance to obstacle	Multi-information display	Remote Touch screen	
		8-inch display (insert display)	12.3-inch display
4.9 ft. (150 cm) to 2.0 ft. (60 cm)	 (continuous)	 (blinking slowly)	 (continuous)
2.0 ft. (60 cm) to 1.5 ft. (45 cm)	 (continuous)	 (blinking)	 (continuous)
1.5 ft. (45 cm) to 1.1 ft. (35 cm)	 (continuous)	 (blinking rapidly)	 (continuous)
Less than 1.1 ft. (35 cm)	 (blinking)	 (continuous)	 (continuous)

### ■ Buzzer operation and distance to an obstacle

A buzzer sounds when the corner sensors and rear center sensors are operating.

- The buzzer beeps faster as the vehicle approaches an obstacle. When the vehicle comes within the following distance of the obstacle, the buzzer sounds continuously:
  - Front center sensors: Approximately 1.0 ft. (30 cm)
  - Corner sensors: Approximately 1.0 ft. (30 cm)
  - Rear center sensors: Approximately 1.1 ft. (35 cm)
- When 2 or more obstacles are detected simultaneously, the buzzer system responds to the nearest obstacle. If one or both come within the above distances, the beep will repeat a long tone, followed by fast beeps.

### Detection range of the sensors

- ① Approximately 3.3 ft. (100 cm)
- ② Approximately 4.9 ft. (150 cm)
- ③ Approximately 2.0 ft. (60 cm)

The diagram shows the detection range of the sensors. Note that the sensors cannot detect obstacles that are extremely close to the vehicle.

The range of the sensors may change depending on the shape of the object etc.



## Setting up intuitive parking assist

You can change the warning beep volume and Remote Touch screen operating conditions.

- 1 Press the "MENU" button on the Remote Touch. (→P. 306)
- 2 Select "SETUP" on the "Menu" screen.
- 3 Select "Vehicle" on the "Setup" screen.
- 4 Select "Lexus Park Assist" on the "Vehicle Settings" screen.
  - ① Alert volume setting
  - ② Display on/off
  - ③ Alert distance setting

Make sure to save after changing settings.



تلفن شبانه روزی: ۰۲۱-۸۸۶۲۰۸۵

FarmaSOS.com

### ■ Alert volume setting

The alert volume can be adjusted.

- 1 Select "1" to "5" on the "LEXUS Park Assist settings".
- 2 Select "Save".

### ■ Display on/off setting

On or off can be selected for intuitive parking assist display.

- 1 Select "Display Off".

When the "Display Off" indicator is turned on, the display of intuitive parking assist will be off. Select "Display Off" again to turn the display of intuitive parking assist on.

- 2 Select "Save".

### ■ Alert distance setting

Front or rear center sensors display and tone indication can be set.

- 1 Select "Front" or "Rear".

Long distance or short distance can be selected.

- 2 Select "Save".

### ■ The intuitive parking assist can be operated when

- Front center sensors:
  - The engine switch is in IGNITION ON mode.
  - The shift lever is in a position other than P.
  - The vehicle speed is less than about 6 mph (10 km/h).
- Front corner sensors:
  - The engine switch is in IGNITION ON mode.
  - The shift lever is in a position other than P or R.
  - The vehicle speed is less than about 6 mph (10 km/h).
- Rear corner and rear center sensors:
  - The engine switch is in IGNITION ON mode.
  - The shift lever is in R.

### ■ Intuitive parking assist display

When an obstacle is detected while the rear view monitor system, is in use, the warning indicator will appear in the top right of the screen even if the display setting has been set to off.

### ■ Sensor detection information

- The sensor's detection areas are limited to the areas around the vehicle's front corner and rear bumpers.
- Certain vehicle conditions and the surrounding environment may affect the ability of the sensor to correctly detect obstacles. Particular instances where this may occur are listed below.
  - There is dirt, snow or ice on the sensor. (Wiping the sensors will resolve this problem.)
  - The sensor is frozen. (Thawing the area will resolve this problem.)  
In especially cold weather, if a sensor is frozen the screen may show an abnormal display, or obstacles may not be detected.
  - The sensor is covered in any way.
  - The vehicle is leaning considerably to one side.
  - On an extremely bumpy road, on an incline, on gravel, or on grass.
  - The vicinity of the vehicle is noisy due to vehicle horns, motorcycle engines, air brakes of large vehicles, or other loud noises producing ultrasonic waves.
  - There is another vehicle equipped with parking assist sensors in the vicinity.
  - The sensor is coated with a sheet of spray or heavy rain.
  - The vehicle is equipped with a fender pole or wireless antenna.
  - Towing eyelets are installed.
  - The bumper or sensor receives a strong impact.
  - The vehicle is approaching a tall or curved curb.
  - In harsh sunlight or intense cold weather.
  - The area directly under the bumpers is not detected.
  - If obstacles draw too close to the sensor.
  - A non-genuine Lexus suspension (lowered suspension etc.) is installed.
  - People may not be detected if they are wearing certain types of clothing.

In addition to the examples above, there are instances in which, because of their shape, signs and other objects may be judged by the sensor to be closer than they are.

- The shape of the obstacle may prevent the sensor from detecting it. Pay particular attention to the following obstacles:
  - Wires, fences, ropes, etc.
  - Cotton, snow and other materials that absorb sound waves
  - Sharply-angled objects
  - Low obstacles
  - Tall obstacles with upper sections projecting outwards in the direction of your vehicle
- The following situations may occur during use.
  - Depending on the shape of the obstacle and other factors, the detection distance may shorten, or detection may be impossible.
  - Obstacles may not be detected if they are too close to the sensor.
  - There will be a short delay between obstacle detection and display. Even at slow speeds, there is a possibility that the obstacle will come within the sensor's detection areas before the display is shown and the warning beep sounds.
  - Thin posts or objects lower than the sensor may not be detected for collision when approached, even if they have been detected once.
  - It might be difficult to hear beeps due to the volume of audio system or air flow noise of air conditioning system.

#### ■ If a message is displayed on the multi-information display

→P. 700, 707

#### ■ Certification

- ▶ For vehicles sold in the U.S.A.

This device complies with Part 15 of the FCC Rules. Operation is subject to the following two conditions; (1) This device may not cause harmful interference, and (2) this device must accept any interference received, including interference that may cause undesired operation.

- ▶ For vehicles sold in Canada

This ISM device complies with Canadian ICES-001.

Cet appareil ISM est conforme a la norme NMB-001 du Canada.

 CAUTION**■ When using the intuitive parking assist**

Observe the following precautions.

Failing to do so may result in the vehicle being unable to be driven safely and possibly cause an accident.

- Do not use the sensor at speeds in excess of 6 mph (10 km/h).
- The sensors' detection areas and reaction times are limited. When moving forward or reversing, check the areas surrounding the vehicle (especially the sides of the vehicle) for safety, and drive slowly, using the brake to control the vehicle's speed.
- Do not install accessories within the sensors' detection areas.

 NOTICE**■ When using intuitive parking assist-sensor**

In the following situations, the system may not function correctly due to a sensor malfunction etc. Have the vehicle checked by your Lexus dealer.

- The intuitive parking assist operation display flashes, and a beep sounds when no obstacles are detected.
- If the area around a sensor collides with something, or is subjected to strong impact.
- If the bumper collides with something.
- If the display shows continuously without a beep.
- If a display error occurs, first check the sensor.  
If the error occurs even if there is no ice, snow or mud on the sensor, it is likely that the sensor is malfunctioning.

**■ Notes when washing the vehicle**

Do not apply intensive bursts of water or steam to the sensor area.

Doing so may result in the sensor malfunctioning.



## Rear view monitor system

The rear view monitor system assists the driver by displaying an image of the view behind the vehicle and fixation guide lines while backing up, for example while parking.

The screen illustrations used in this text are intended as examples, and may differ from the image that is actually displayed on the screen.

Rear view monitor system will activate when the shift lever is in R.

If you move the lever out of R, the rear view monitor system will be deactivated.

When the shift lever is shifted to the R position and any mode button (such as "MENU") is pressed, the rear view monitor system is canceled, and the screen is switched to the mode of the button that was pressed.

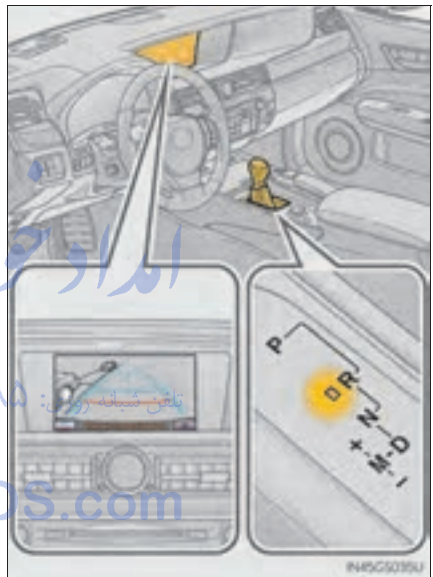

## Using the rear view monitor system

### ■ Screen description

The rear view monitor system screen will be displayed if the shift lever is shifted to R while the engine switch is in IGNITION ON mode.

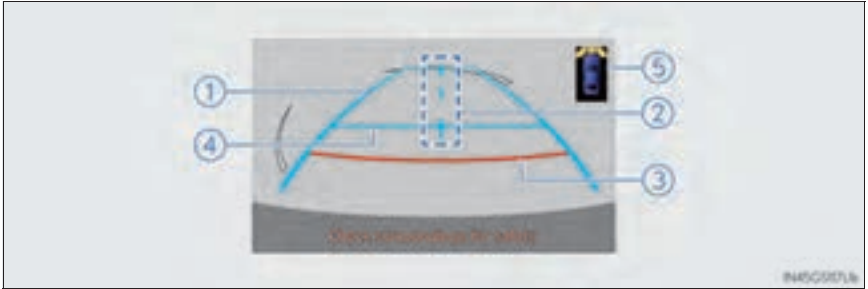

#### ① Vehicle width extension guide line

The line indicates a guide path when the vehicle is being backed straight up. The displayed width is wider than the actual vehicle width.

#### ② Vehicle center guide lines

These lines indicate the estimated vehicle center on the ground.

#### ③ Distance guide line

The line shows points approximately 1.5 ft. (0.5 m) (red) from the center of the edge of the bumper.

#### ④ Distance guide line

The line shows distance behind the vehicle, a point approximately 3 ft. (1 m) (blue) from the edge of the bumper.

#### ⑤ Intuitive parking assist display (if equipped)

If an obstacle is detected while the Intuitive parking assist-sensor is on, a display is shown in the top right corner of the screen.

## Rear view monitor system precautions

### ■ Area displayed on screen

The rear view monitor system displays an image of the view from the bumper of the rear area of the vehicle.

To adjust the image on the rear view monitor system screen. (→P. 310)

- The area displayed on the screen may vary according to vehicle orientation conditions.
- Objects which are close to either corner of the bumper or under the bumper cannot be seen on the screen.
- The camera uses a special lens. The distance of the image that appears on the screen differs from the actual distance.
- Items which are located higher than the camera may not be displayed by the monitor.

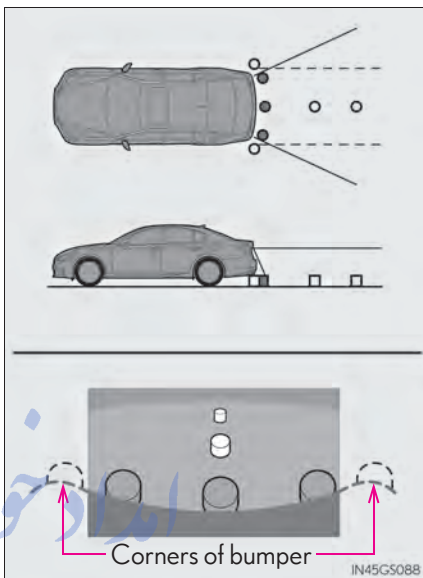

### ■ Rear view monitor system camera

The camera for the rear view monitor system is located above the license plate.

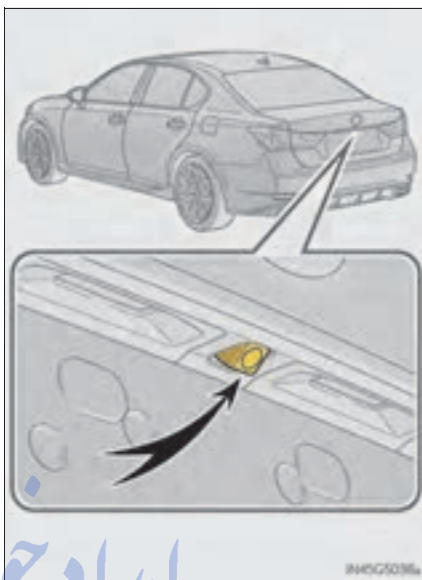

### ● Using the camera

If the camera lens becomes dirty, it cannot transmit a clear image. If water droplets, snow or mud adhere to the lens, rinse with water and wipe with a soft cloth. If the lens is extremely dirty, wash it with a mild cleanser and rinse.

### ■ Differences between the screen and the actual road

The distance guide lines and the vehicle width extension guide lines may not actually be parallel with the dividing lines of the parking space, even when they appear to be so. Be sure to check visually.

The distances between the vehicle width extension guide lines and the left and right dividing lines of the parking space may not be equal, even when they appear to be so. Be sure to check visually.

The distance guide lines give a distance guide for flat road surfaces. In any of the following situations, there is a margin of error between the fixation guide lines on the screen and the actual distance/course on the road.

- When the ground behind the vehicle slopes up sharply

The distance guide lines will appear to be closer to the vehicle than the actual distance. Because of this, objects will appear to be farther away than they actually are. In the same way, there will be a margin of error between the guidelines and the actual distance/course on the road.

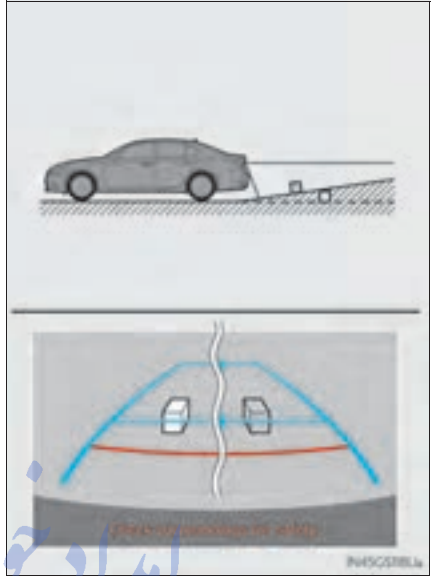

- When the ground behind the vehicle slopes down sharply

The distance guide lines will appear to be further from the vehicle than the actual distance. Because of this, objects will appear to be closer than they actually are. In the same way, there will be a margin of error between the guidelines and the actual distance/course on the road.

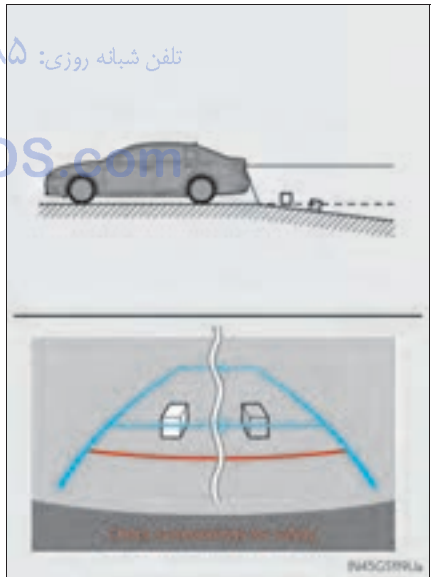

- When any part of the vehicle sags

When any part of the vehicle sags due to the number of passengers or the distribution of the load, there is a margin of error between the fixation guide lines on the screen and the actual distance/course on the road.

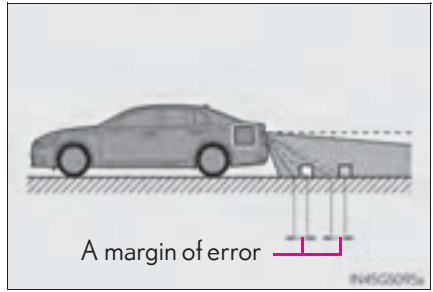

- When approaching three-dimensional objects

The distance guide lines are displayed according to flat surfaced objects (such as the road). It is not possible to determine the position of three-dimensional objects (such as vehicles) using the distance guide lines. When approaching a three-dimensional object that extends outward (such as the flatbed of a truck), be careful of the following.

- Distance guidelines

Visually check the surroundings and the area behind the vehicle. On the screen, it appears that a truck is parking at point ②. However, in reality if you back up to point ①, you will hit the truck. On the screen, it appears that ① is closest and ③ is furthest away. However, in reality, the distance to ① and ③ is the same, and ② is farther than ① and ③.

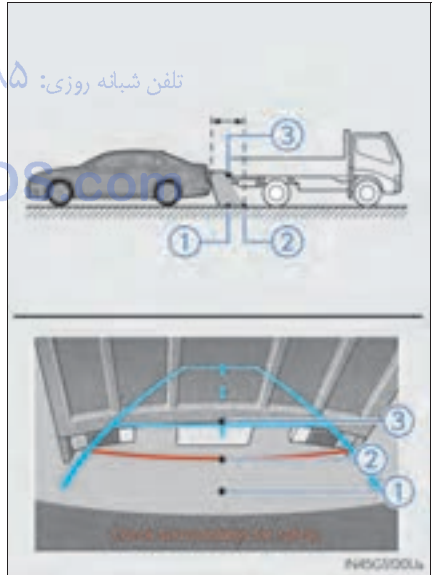

### ■ Vehicle width extension guide lines

Visually check the surroundings and the area behind the vehicle. In the case shown below, the truck appears to be outside of the vehicle width extension guide lines and the vehicle does not look as if it hits the truck. However, the rear body of the truck may actually cross over the vehicle width extension guide lines. In reality if you back up as guided by the vehicle width extension guide lines, the vehicle may hit the truck.

Vehicle width extension guide lines

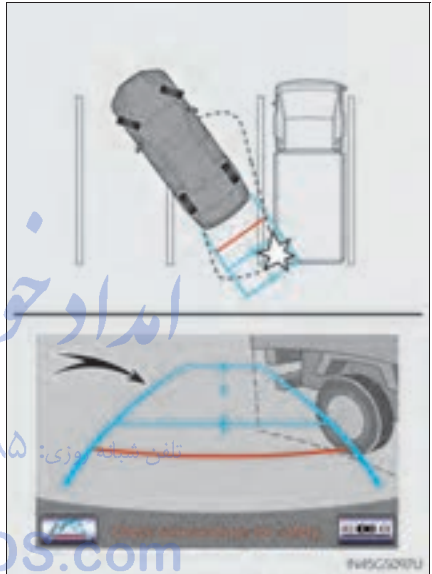

## Things you should know

### ■ If you think something is wrong

If you notice any of the following symptoms, refer to the likely cause and the solution, and re-check.

If the symptom is not resolved by the solution, have the vehicle inspected by your Lexus dealer.

Symptom	Likely cause	Solution
The image is difficult to see	<ul style="list-style-type: none"> <li>• The vehicle is in a dark area</li> <li>• The temperature around the lens is either high or low</li> <li>• The outside temperature is low</li> <li>• There are water droplets on the camera</li> <li>• It is raining or humid</li> <li>• Foreign matter (mud etc.) is adhering to the camera</li> <li>• There are scratches on the camera</li> <li>• Sunlight or headlights are shining directly into the camera</li> <li>• The vehicle is under fluorescent lights, sodium lights, mercury lights etc.</li> </ul>	<p>If this happens due to these causes, it does not indicate a malfunction. Back up while visually checking the vehicle's surroundings. (Use the monitor again once conditions have been improved.)</p> <p>To adjust the image on the rear view monitor system screen. (→P. 310)</p>
The image is blurry	Dirt or foreign matter (such as water droplets, snow, mud etc.) is adhering to the camera.	Rinse the camera lens with water and wipe it clean with a soft cloth. Wash with a mild soap if the dirt is stubborn.



Symptom	Likely cause	Solution
The image is out of alignment	The camera or surrounding area has received a strong impact.	Have the vehicle inspected by your Lexus dealer.
The fixation guide lines are very far out of alignment	The camera position is out of alignment.	Have the vehicle inspected by your Lexus dealer.

امداد خودرو فارما

تلفن شبانه روزی: ۰۲۱-۸۸۸۶۲۰۸۵

FarmaSOS.com

**⚠ CAUTION****■ When using the rear view monitor system**

When backing up, be sure to check visually behind and all around the vehicle before proceeding.

Observe the following precautions to avoid an accident that could result in death or serious injuries.

- The rear view monitor system is a supplemental device intended to assist the driver when backing up. Never depend on the rear view monitor system entirely when backing up. Always make sure your intended path is clear. Use caution, just as you would when backing up any vehicle.
- Never back up while looking only at the screen. The image shown on the screen may differ from the actual state, and you could collide with another vehicle or obstacles if backing up looking only at the screen, possibly causing an accident. When backing up, be sure to check in front of and behind the vehicle, both directly and with mirrors.
- Be sure to back up slowly, depressing the brake pedal to control vehicle speed.
- The instructions given are only guidelines. When and how much to turn the steering wheel will vary according to traffic conditions, road surface conditions, vehicle condition, etc. when parking. It is necessary to be fully aware of this before using the rear view monitor system.
- When parking, be sure to check that the parking space will accommodate your vehicle before maneuvering into it.
- Do not use system in the following cases:
  - On icy or slick road surfaces, or in snow
  - When using tire chains or the compact spare tire
  - When the trunk lid is not closed completely
  - On roads that are not flat or straight, such as curves or slopes.
- In low temperatures, the screen may darken or the image may become faint. The image could distort when the vehicle is moving, or you may become unable to see the image on the screen. Be sure to check direct visually and with mirror all around the vehicle before proceeding.
- If the tire sizes are changed, the position of the fixation guide lines displayed on the screen may change.
- The camera uses a special lens. The distances between objects and pedestrians that appear in the image displayed on the screen will differ from the actual distances. (→P. 254)

 CAUTION**■ When using the rear view monitor system screen**

- The position of the fixation guide lines displayed on the screen may change in accordance with the number of passengers, the amount of cargo etc. Be sure to check behind and all around the vehicle direct visually and with mirror before proceeding.
- The vehicle width extension guide lines are wider than the actual width of the vehicle. When backing up, be sure to check behind and all around the vehicle direct visually and with mirror before proceeding.

امداد خودرو فارما

تلفن شبانه روزی: ۰۲۱-۸۸۶۲۰۸۵

FarmaSOS.com

 NOTICE**■ How to use the camera**

- The rear view monitor system may not operate properly in the following cases, or if the precautions described below are not followed.
  - If the back of the vehicle is hit, the position and mounting angle of the camera may change.
  - As the camera has a water proof construction, do not detach, disassemble or modify it. This may cause incorrect operation.
  - Do not strongly rub the camera lens. If the camera lens is scratched, it cannot transmit a clear image.
  - Do not allow organic solvent, car wax, window cleaner or glass coat to adhere to the camera. If this happens, wipe it off as soon as possible.
  - If the temperature changes rapidly, such as when hot water is poured on the vehicle in cold weather, the system may not operate normally.
  - When washing the vehicle, do not apply intensive bursts of water to the camera or camera area. Doing so may result in the camera malfunctioning.
  - When the camera is used under fluorescent lights, sodium light or mercury light etc., the lights and the illuminated areas may appear to flicker.
- Do not expose the camera to strong impact as this could cause a malfunction. If this happens, have the vehicle inspected by your Lexus dealer as soon as possible.

تلفن شبانه روزی: +۹۰-۸۸۶۲۰۸۵

FarmaSOS.com

## Driving mode select switch

The driving modes can be selected to suit driving condition.

### Vehicles without AVS

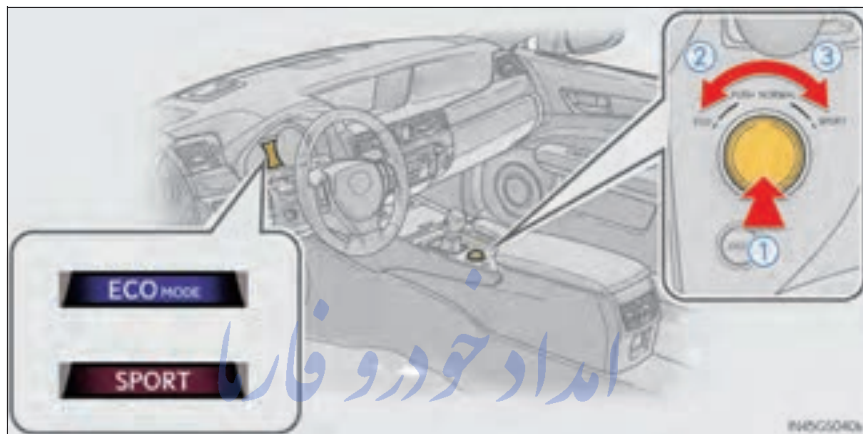

#### ① Normal mode

For normal driving.

Press the switch to change the driving mode to normal mode when selected to Eco mode or sport mode.

#### ② Eco drive mode

Use Eco mode to help achieve low fuel consumption during trips that involve frequent accelerating.

When the driving mode select switch is turned left, the "ECO MODE" indicator comes on in the multi-information display.

### ③ Sport mode

An acceleration response suitable for sports driving is provided by controlling steering response and transmission. Suitable for when precise handling is desirable, for example when driving on mountain roads.

When the driving mode select switch is turned right, the "SPORT" indicator comes on in the instrument cluster.

Also, on vehicles equipped with a 12.3-inch display, the driving mode is also automatically displayed on the "Side Display". (→P. 308)

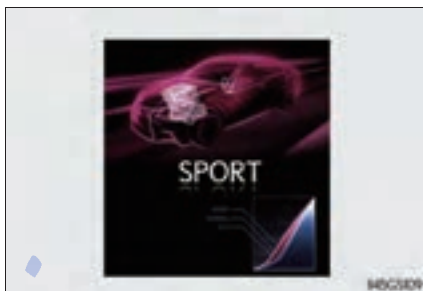

امداد خودرو فارما

تلفن شبانه روزی: ۰۲۱-۸۸۶۲۰۸۵

FarmaSOS.com

## Vehicles with AVS

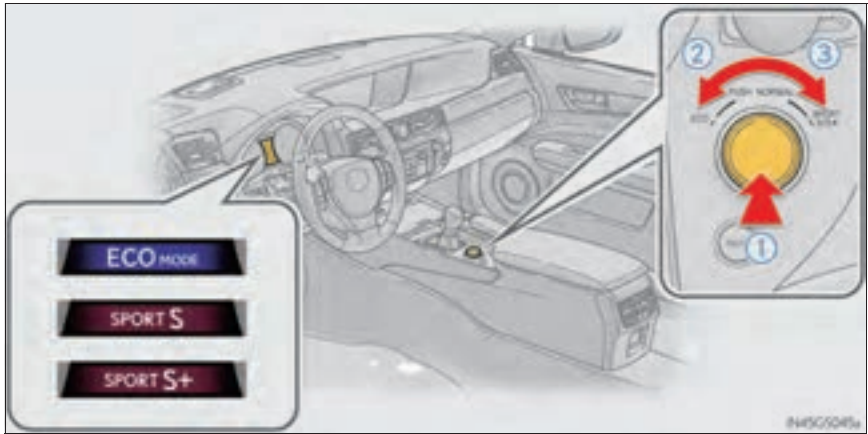

## ① Normal mode

For normal driving.

Press the switch to change the driving mode to normal mode when selected to Eco mode or sport mode.

## ② Eco drive mode

Use Eco mode to help achieve low fuel consumption during trips that involve frequent accelerating.

When the driving mode select switch is turned left, the "ECO MODE" indicator comes on in the multi-information display.

### ③ Sport mode

- SPORT S mode

Improves acceleration response by controlling the transmission. Suitable for when precise handling is desirable, for example when driving on mountain roads.

When the driving mode select switch is turned right while a mode other than SPORT S mode is selected, the “SPORT S” indicator comes on in the instrument cluster.

Also, on vehicles equipped with a 12.3-inch display, the driving mode is also automatically displayed on the “Side Display”. (→P. 308)

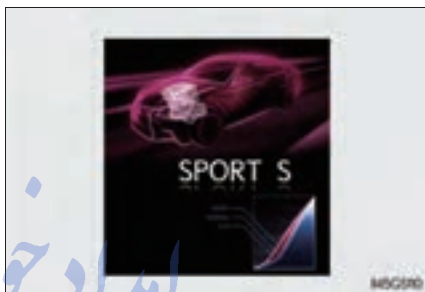

- SPORT S+ mode

Improves steering performance and driving stability by simultaneously controlling the steering and suspension in addition to the transmission. Suitable for sporty driving.

When the driving mode select switch is turned right while SPORT S mode is selected, the “SPORT S+” indicator comes on in the instrument cluster.

Also, on vehicles equipped with a 12.3-inch display, the driving mode is also automatically displayed on the “Side Display”. (→P. 308)

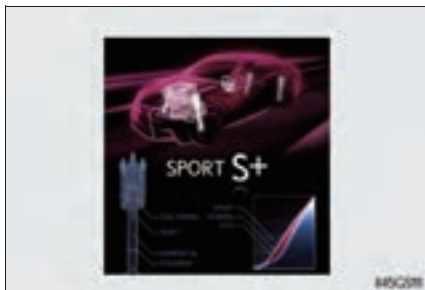



**■ Operation of the air conditioning system in Eco drive mode**

Eco drive mode controls the heating/cooling operations and fan speed of the air conditioning system to enhance fuel efficiency. To improve air conditioning performance, adjust the fan speed or turn off Eco drive mode. (→P. 345)

**■ Automatic operation of the seat heater during Eco drive mode**

If the driving mode select switch is switched to Eco drive mode in cold temperatures, the seat heater will be automatically operated to assist heating performance.

**■ Sport mode automatic deactivation**

Sport mode is automatically deactivated if the engine switch is turned off after driving in sport mode.

امداد خودرو فارما

تلفن شبانه روزی: ۰۲۱-۸۸۶۲۰۸۵

FarmaSOS.com

## Driving assist systems

To help enhance driving safety and performance, the following systems operate automatically in response to various driving situations. Be aware, however, that these systems are supplementary and should not be relied upon too heavily when operating the vehicle.

### ◆ ABS (Anti-lock Brake System)

Helps to prevent wheel lock when the brakes are applied suddenly, or if the brakes are applied while driving on a slippery road surface

### ◆ Brake assist

Generates an increased level of braking force after the brake pedal is depressed when the system detects a panic stop situation

### ◆ VSC (Vehicle Stability Control)

Helps the driver to control skidding when swerving suddenly or turning on slippery road surfaces

### ◆ Enhanced VSC (Enhanced Vehicle Stability Control)

Provides cooperative control of the ABS, TRAC, VSC and EPS. Helps to maintain directional stability when swerving on slippery road surfaces by controlling steering performance.

### ◆ TRAC (Traction Control)

Helps to maintain drive power and prevent the drive wheels from spinning when starting the vehicle or accelerating on slippery roads

### ◆ Hill-start assist control

→P. 276

### ◆ VGRS (Variable Gear Ratio Steering) (if equipped)

Adjusts the front wheel turning angle in accordance with the vehicle speed and steering wheel movement

---

**◆ DRS (Dynamic Rear Steering) (if equipped)**

---

Contributes to the turning characteristics and responsiveness of the vehicle by slightly adjusting the rear wheel angle of the vehicle in accordance with steering wheel movement.

---

**◆ EPS (Electric Power Steering)**

---

Employs an electric motor to reduce the amount of effort needed to turn the steering wheel

---

**◆ AVS (Adaptive Variable Suspension system) (if equipped)**

---

By independently controlling the damping force of the shock absorbers for each of the 4 wheels according to the road and driving conditions, this system combines riding comfort with superior steering stability, and ensures good vehicle posture. (→P. 263)

---

**◆ LDH (Lexus Dynamic Handling system) (if equipped)**

---

Provides independent control of the VGRS, DRS and EPS. Contributes to turning characteristics at low speeds, responsiveness at medium speeds and safety at high speeds by controlling the steering angle of the front and rear wheels in accordance with the steering wheel operation and vehicle speed.

---

**◆ VDIM (Vehicle Dynamics Integrated Management)**

---

Provides integrated control of the ABS, brake assist, TRAC, VSC, hill-start assist control, EPS, VGRS (if equipped) and DRS (if equipped) systems

Helps to maintain vehicle stability when swerving on slippery road surfaces by controlling the brakes, engine output, steering assist, and steering ratio

---

**◆ PCS (Pre-Collision System) (if equipped)**

---

→P. 278

### When the TRAC/VSC systems are operating

The slip indicator light will flash while the TRAC/VSC systems are operating.



### Disabling the TRAC/VSC systems

If the vehicle gets stuck in fresh snow or mud, the TRAC/VSC systems may reduce power from the engine to the wheels. You may need to turn the system off to enable you to rock the vehicle in order to free it.

#### ■ Turning off the TRAC system only

To turn the TRAC system off, quickly press and release the button.

The "TRAC OFF" will be shown on the multi-information display. Press the button again to turn the system back on.



### ■ Turning off both TRAC/VSC systems

To turn the TRAC/VSC systems off, press and hold the button for more than 3 seconds while the vehicle is stopped.

The VSC OFF indicator light will come on and the "TRAC OFF" will be shown on the multi-information display.

Press the button again to turn the systems back on.



امداد خودرو فارما

تلفن شبانه روزی: ۰۲۱-۸۸۶۲۰۸۵

FarmaSOS.com

- **When the message is displayed on the multi-information display showing that TRAC has been disabled even if the VSC OFF switch has not been pressed**

TRAC cannot be operated. Contact your Lexus dealer.

- **VGRS is disabled when**

VGRS may stop operating in the following situations.

In this event, the steering wheel may move from its straight forward position, but it will return when the system restarts.

- The steering wheel is operated for an extended period of time while the vehicle is stopped or is moving very slowly.
- When force is continuously applied for a long time with the steering wheel turned as far as it will go.

The center position of the steering wheel may change when VGRS is disabled. However, the position will return to normal after VGRS is reactivated.

- **When the battery is disconnected**

The steering wheel may move from its straight forward position, but this will be corrected automatically when driving.

- **Sounds and vibrations caused by the ABS, brake assist, VSC, TRAC and VGRS systems**

- A sound may be heard from the engine compartment when the engine is started or just after the vehicle begins to move. This sound does not indicate that a malfunction has occurred in any of these systems.

- Any of the following conditions may occur when the above systems are operating. None of these indicates that a malfunction has occurred.

- Vibrations may be felt through the vehicle body and steering.
- A motor sound may be heard after the vehicle comes to a stop.
- The brake pedal may pulsate slightly after the ABS is activated.
- The brake pedal may move down slightly after the ABS is activated.

- **EPS, VGRS and DRS operation sound**

When the steering wheel is operated, a motor sound (whirring sound) may be heard. This does not indicate a malfunction.

- **Reactivation of the TRAC/VSC systems**

Even after the TRAC/VSC systems have been turned off, turning the engine off and then on again will automatically reactivate the TRAC/VSC systems.

### ■ Reactivation of the TRAC system linked to vehicle speed

When only the TRAC system is turned off, the TRAC system will turn on when vehicle speed increases. However, when both TRAC/VSC systems are turned off, the systems will not turn on even when vehicle speed increases.

### ■ Reduced effectiveness of the EPS system

The effectiveness of the EPS system is reduced to prevent the system from overheating when there is frequent steering input over an extended period of time. The steering wheel may feel heavy as a result.\* Should this occur, refrain from excessive steering input or stop the vehicle and turn the engine off. The effectiveness will improve after a short while.

\*: If the LKA (Lane-Keeping Assist) system cannot operate in this case, a warning message will be shown on the multi-information display.

امداد خودرو فارما

تلفن شبانه روزی: ۰۲۱-۸۸۶۲۰۸۵

FarmaSOS.com

**⚠ CAUTION****■ The ABS does not operate effectively when**

- Tires with inadequate gripping ability are used (such as excessively worn tires on a snow covered road).
- The vehicle hydroplanes while driving at high speed on wet or slick roads.

**■ Stopping distance when the ABS is operating may exceed that of normal conditions**

The ABS is not designed to shorten the vehicle's stopping distance. Always maintain a safe distance from the vehicle in front of you in the following situations:

- When driving on dirt, gravel or snow-covered roads
- When driving with tire chains
- When driving over bumps in the road
- When driving over roads with potholes or uneven surfaces

**■ TRAC may not operate effectively when**

Directional control and power may not be achievable while driving on slippery road surfaces, even if the TRAC system is operating.

Do not drive the vehicle in conditions where stability and power may be lost.

**■ When the VSC is activated**

The slip indicator light flashes. Always drive carefully. Reckless driving may cause an accident. Exercise particular care when the indicator light flashes.

**■ When the TRAC/VSC systems are turned off**

Be especially careful and drive at a speed appropriate to the road conditions. As these are the systems to ensure vehicle stability and driving force, do not turn the TRAC/VSC systems off unless necessary.



**⚠ CAUTION****■ Replacing tires**

Make sure that all tires are of the specified size, brand, tread pattern and total load capacity. In addition, make sure that the tires are inflated to the recommended tire inflation pressure level.

The ABS, TRAC and VSC systems will not function correctly if different tires are installed on the vehicle.

Contact your Lexus dealer for further information when replacing tires or wheels.

**■ Handling of tires and the suspension**

Using tires with any kind of problem or modifying the suspension will affect the driving assist systems, and may cause a system to malfunction.

امداد خودرو فارما

تلفن شبانه روزی: ۰۲۱-۸۸۶۲۰۸۵

FarmaSOS.com

## Hill-start assist control

Assists with starting off and temporarily maintains braking power even if the foot is removed from the brake pedal when starting off on an incline or a slippery slope.

To engage hill-start assist control, further depress the brake pedal when the vehicle is stopped completely.

A buzzer will sound once to indicate the system is activated. The slip indicator will also start flashing.



### ■ Hill-start assist control operating conditions

- The system operates in the following situations:
  - The shift lever is in a position other than P.
  - The parking brake is not applied.
  - The accelerator pedal is not depressed.
- Hill-start assist control cannot be operated while the slip indicator light is illuminated.

### ■ Hill-start assist control

- While hill-start assist control is operating, the brakes remain automatically applied after the driver releases the brake pedal. The stop lights and the high mounted stoplight turn on.
- Hill-start assist control operates for about 2 seconds after the brake pedal is released.
- If the slip indicator does not flash and the buzzer does not sound when the brake pedal is further depressed, slightly reduce the pressure on the brake pedal (do not allow the vehicle to roll backward) and then firmly depress it again. If the system still does not operate, check that the operating conditions explained above have been met.

### ■ Hill-start assist control buzzer

- When hill-start assist control is activated, the buzzer will sound once.
- In the following situations, hill-start assist control will be canceled and the buzzer will sound twice.
  - No attempt is made to drive the vehicle within approximately 2 seconds of releasing the brake pedal.
  - The shift lever is moved to P.
  - The parking brake is applied.
  - The brake pedal is depressed again.
  - The brake pedal has been depressed for more than approximately 3 minutes.

### ■ If the slip indicator comes on

It may indicate a malfunction in the system. Contact your Lexus dealer.

### CAUTION

#### ■ Hill-start assist control

- Do not overly rely on hill-start assist control. Hill-start assist control may not operate effectively on steep inclines and roads covered with ice.
- Unlike the parking brake, hill-start assist control is not intended to hold the vehicle stationary for an extended period of time. Do not attempt to use hill-start assist control to hold the vehicle on an incline, as doing so may lead to an accident.

FarmaSOS.com

## PCS (Pre-Collision System)\*

When the radar sensor detects that a frontal collision is highly likely or even unavoidable, safety systems such as the brakes and seat belts are automatically engaged to lessen impact as well as vehicle damage.

The pre-collision system can be turned on and off as necessary by operating the switch. (→P. 280)

### ◆ Pre-collision seat belts (front seat only)

If the pre-collision sensor detects that a collision is unavoidable, the pre-collision system will retract the seat belt before the collision occurs. The same will happen if the driver makes an emergency braking or loses control of the vehicle. (→P. 32)

### ◆ Pre-collision brake assist

When there is a high possibility of a frontal collision, the system applies greater braking force in relation to how strongly the brake pedal is depressed. تلفن شبانه روزی: ۰۲۱-۸۸۶۲۰۸۵

### ◆ Pre-collision braking

When there is a high possibility of a frontal collision, the system warns the driver using a warning light, warning display and buzzer. If the system determines that a collision is unavoidable, the brakes are automatically applied to reduce the collision speed.

### ◆ Suspension control (if equipped)

---

When the system determines that a collision is unavoidable, the operation of AVS (→P. 269) optimally controls the damping force of the shock absorber.

### ◆ Steering control (if equipped)

---

#### ▶ Vehicles with VGRS

There is a high possibility of collision and if the steering wheel is operated, the steering gear ratio is changed by VGRS to help improve the response to steering input.

#### ▶ Vehicles with LDH

There is a high possibility of collision and if the steering wheel is operated, the steering angles of the front and rear wheels and the heaviness of the steering wheel are controlled by LDH, thus heightening responsiveness in response to the steering operation.

### ◆ Driver monitor system (if equipped)

---

When the system determines that there is a possibility of a collision, and either the driver is not facing forward or the driver's eyes are closed, PCS warnings are given in advance to warn the driver. If the system determines that the conditions to operate pre-collision alert braking have been met even when the possibility of a collision increases further, pre-collision alert braking will operate.

## Disabling pre-collision system

- ① Enabled
- ② Disabled

The “PCS” warning light comes on when pre-collision system is disabled.

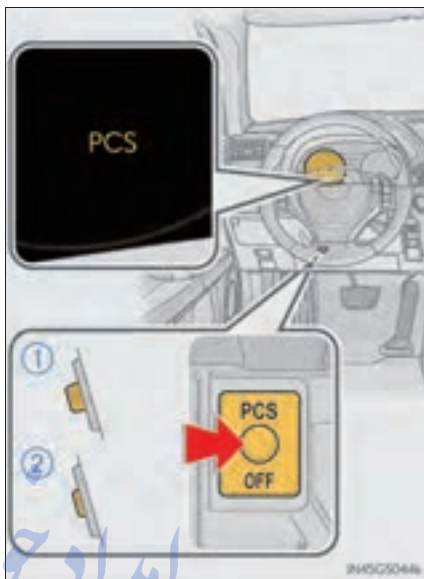

## Radar sensor

The radar sensor detects vehicles or other obstacles on or near the road ahead and determines whether a collision is imminent based on the position, speed, and heading of the obstacles

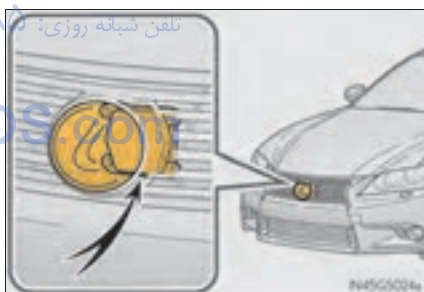

## Driver monitor sensor (if equipped)

The driver monitor sensor detects the direction the driver is facing and whether the driver's eyes are open or closed.

The system determines whether the driver is facing forward and whether or not the driver's eyes are closed.



### ■ The pre-collision system is operational when

The pre-collision system off button is not pressed and the following conditions are met:

- Pre-collision warning:
  - Vehicle speed is greater than about 10 mph (15 km/h).
  - The speed at which your vehicle is approaching the obstacle or oncoming vehicle is greater than about 10 mph (15 km/h).
- Pre-collision seat belts (operating conditions A):
  - Vehicle speed is greater than about 19 mph (30 km/h).
  - The system detects sudden braking or skidding.
  - The front occupants are wearing a seat belt.
- Pre-collision seat belts (operating conditions B):
  - Vehicle speed is greater than about 4 mph (5 km/h).
  - The speed at which your vehicle is approaching the obstacle or oncoming vehicle is greater than about 19 mph (30 km/h).
  - The front occupants are wearing a seat belt.
- Pre-collision brake assist:
  - Vehicle speed is greater than about 19 mph (30 km/h).
  - The speed at which your vehicle is approaching the obstacle or the vehicle running ahead of you is greater than about 19 mph (30 km/h).
  - The brake pedal is depressed.
- Pre-collision braking:
  - Vehicle speed is greater than about 10 mph (15 km/h).
  - The speed at which your vehicle is approaching the obstacle or the vehicle running ahead of you is greater than about 10 mph (15 km/h).
- Suspension control:
  - Vehicle speed is greater than about 4 mph (5 km/h).
  - The speed at which your vehicle is approaching the obstacle or the vehicle running ahead of you is greater than about 19 mph (30 km/h).
- Steering control:
  - Vehicle speed is greater than about 19 mph (30 km/h).
  - The speed at which your vehicle is approaching the obstacle or the vehicle running ahead of you is greater than about 19 mph (30 km/h).
- Pre-collision alert braking:
  - The system determines that the driver is not facing forward, or that the driver's eyes are closed.
  - Vehicle speed is greater than about 25 mph (40 km/h).
  - The speed at which your vehicle is approaching the vehicle running ahead of you is greater than about 25 mph (40 km/h).
  - The steering is not being turned.

### ■ Conditions that may trigger the system even if there is no danger of a collision

- When there is an object by the roadside at the entrance to a curve
- When passing an oncoming vehicle on a curve
- When driving over a narrow iron bridge
- When there is a metal object on the road surface
- When driving on an uneven road surface
- When passing an oncoming vehicle on a left-turn
- When your vehicle rapidly closes on the vehicle in front
- When a grade separation/interchange, sign, billboard, or other structure appears to be directly in the vehicle's line of travel
- When climbing a steep hill causes an overhead billboard or other metallic structure to appear directly in the vehicle's line of travel

When the system is activated in the situations described above, there is also a possibility that the seat belts will retract quickly and the brakes will be applied with a force greater than normal. When the seat belt is locked in the retracted position, stop the vehicle in a safe place, release the seat belt and refasten it.

### ■ Obstacles not detected

The sensor cannot detect plastic obstacles such as traffic cones. There may also be occasions when the sensor cannot detect pedestrians, animals, bicycles, motorcycles, trees, or snowdrifts.

### ■ Situations in which the pre-collision system does not function properly

The system may not function effectively in situations such as the following:

- On roads with sharp bends or uneven surfaces
- If a vehicle suddenly moves in front of your vehicle, such as at an intersection
- If a vehicle suddenly cuts in front of your vehicle, such as when overtaking
- In inclement weather such as heavy rain, fog, snow or sand storms
- When your vehicle is skidding such as the VSC system off
- When your vehicle is steeply inclined



### ■ Automatic cancelation of the pre-collision system

When a malfunction occurs due to sensor contamination, etc. that results in the sensors being unable to detect obstacles, the pre-collision system will be automatically disabled. In this case, the system will not activate even if there is a collision possibility.

### ■ When there is a malfunction in the system

“PCS” warning light will flash and warning messages will be displayed.  
(→P. 688, 699)

### ■ Certification

► For vehicles sold in the U.S.A.

FCC ID: HYQDNMWR004

This device complies with Part 15 of the FCC Rules. Operation is subject to the following two conditions: (1) this device may not cause harmful interference, and (2) this device must accept any interference received, including interference that may cause undesired operation.

#### FCC WARNING

Changes or modifications not expressly approved by the party responsible for compliance could void the user's authority to operate the equipment.

Radio frequency radiation exposure Information:

This equipment complies with FCC radiation exposure limits set forth for an uncontrolled environment.

This equipment should be installed and operated with minimum distance of 20 cm between the radiator and your body.

This transmitter must not be co-located or operating in conjunction with any other antenna or transmitter.

► For vehicles sold in Canada

Operation is subject to the following two conditions: (1) this device may not cause interference, and (2) this device must accept any interference, including interference that may cause undesired operation of the device.

## CAUTION

### ■ Limitations of the pre-collision system

Do not overly rely on the pre-collision system. Always drive safely, taking care to observe your surroundings and checking for any obstacles or other road hazards. Failure to do so may cause an accident resulting in death or serious injury.

### ■ Handling the radar sensor

Observe the following to ensure the pre-collision system can function effectively. Otherwise, the system may not function correctly and could result in an accident.

- Keep the sensor and grille cover clean at all times.  
Clean the sensor and grille cover with a soft cloth so you do not mark or damage them.
- Do not subject the sensor or surrounding area to a strong impact.  
If the sensor moves even slightly off position, the system may malfunction. If the sensor or surrounding area is subject to a strong impact, always have the area inspected and adjusted by your Lexus dealer.
- Do not disassemble the sensor.
- Do not attach accessories or stickers to the sensor, grille cover or surrounding area.
- Do not modify or paint the sensor and grille cover.
- Do not replace them with non-genuine parts. تلفن شبانه روزی ۰۲۱-۸۸۶۲۱۱۱

### ■ Determining the direction the driver is facing and whether the driver's eyes are open or closed

The direction the driver is facing and whether the driver's eyes are open or closed may not be determined correctly if the following conditions exist:

- There is an object between the driver monitor sensor and the driver's face, such as when the sensor is blocked.
- A part of the driver's face is covered.
- The sensor or the driver's face is exposed to intense light such as sunlight.
- The driving posture is improper.

 CAUTION**■ Handling the driver monitor sensor**

Observe the following to ensure the driver monitor sensor can function effectively. Failure to do so may result in a malfunction or may prevent the system from correctly determining the direction the driver is facing, resulting in an unexpected accident.

- Do not disassemble, damage, lift or pull on the sensor.
- Do not select the sensor while driving.
- Do not wet or spill water on the sensor.
- Do not drop anything on or allow anything to hit against the sensor. Do not subject the sensor to an impact.
- Make sure that there are no scratches, dirt or stickers on the side of the sensor that faces the driver.
- Do not place any objects in front of the side of the sensor that faces the driver or cover the sensor.

امداد خودرو فارما

تلفن شبانه روزی: ۰۲۱-۸۸۶۲۰۸۵

FarmaSOS.com

 CAUTION**■ Cautions regarding the assist contents of the system**

By means of alarms and brake control, the pre-collision system is intended to assist the driver in avoiding collisions through the process of LOOK-JUDGE-ACT. There are limits to the degree of assistance the system can provide, so please keep in mind the following important points.

**● Assisting the driver in watching the road**

The pre-collision system is only able to detect obstacles directly in front of the vehicle, and only within a limited range. It is not a mechanism that allows careless or inattentive driving, and it is not a system that can assist the driver in low-visibility conditions. It is still necessary for the driver to pay close attention to the vehicle's surroundings.

**● Assisting the driver in making correct judgment**

When attempting to estimate the likelihood of a collision, the only data available to the pre-collision system is that from obstacles it has detected directly in front of the vehicle. Therefore, it is absolutely necessary for the driver to remain vigilant and to determine whether or not there is a possibility of collision in any given situation.

**● Assisting the driver in taking action**

The pre-collision system's braking assist feature is designed to help reduce the severity of a collision, and so only acts when the system has judged that a collision is unavoidable. This system by itself is not capable of automatically avoiding a collision or bringing the vehicle to a stop safely. For this reason, when encountering a dangerous situation the driver must take direct and immediate action in order to ensure the safety of all involved.

 NOTICE**■ Precautions for cleaning the driver monitor sensor**

- Gently wipe the sensor with a soft cloth to prevent damage.
- Wipe any excess dirt with a cloth dampened with neutral detergent, all liquids having been wringed out of the cloth. After that, wipe again with a dry cloth.
- Do not use benzene, thinner, glass cleaners, wax, etc.

## BSM (Blind Spot Monitor)\*

The Blind Spot Monitor is a system that assists the driver to confirm safety when changing lanes.

The system uses radar sensors to detect vehicles that are traveling in an adjacent lane in the area that is not reflected in the outside rear view mirror (the blind spot), and advises the driver of the vehicles existence via the outside rear view mirror indicator.



### ① BSM main switch

Pressing the switch turns the system on or off. When the switch is set to on, the switch's indicator illuminates.

### ② Outside rear view mirror indicator

When a vehicle is detected in the blind spot, the outside rear view mirror indicator on that side illuminates. If the turn signal lever is operated when a vehicle is in the blind spot, the outside rear view mirror indicator flashes.

\*: If equipped

## The Blind Spot Monitor detection areas

The blind spot that vehicles can be detected in are outlined below.

The range of the detection area extends to:

- ① Approximately 11.5 ft. (3.5 m) from the side of the vehicle

The first 1.6 ft. (0.5 m) from the side of the vehicle is not in the detection area

- ② Approximately 9.8 ft. (3 m) from the rear bumper

- ③ Approximately 3.3 ft. (1 m) forward of the rear bumper

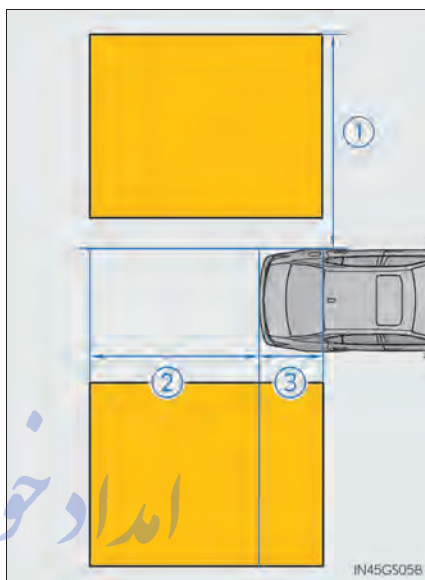

تلفن شبانه روزی: ۰۲۱-۸۸۶۲۰۸۵

FarmaSOS.com

**■ The Blind Spot Monitor system is operational when**

The BSM main switch is set to on and vehicle speed is greater than approximately 25 mph (40 km/h).

**■ The Blind Spot Monitor will detect a vehicle when**

- A vehicle in an adjacent lane overtakes your vehicle.
- Another vehicle enters the detection area when it changes lanes.

**■ Conditions under which the Blind Spot Monitor will not detect a vehicle**

The Blind Spot Monitor system is not designed to detect the following types of vehicles and/or objects:

- Small motorcycles, bicycles, pedestrians etc.\*
- Vehicles traveling in the opposite direction
- Guardrails, walls, signs, parked vehicles and similar stationary objects\*
- Following vehicles that are in the same lane\*
- Vehicles driving 2 lanes across from your vehicle\*

\*: Depending on conditions, detection of a vehicle and/or object may occur.

تلفن شبانه روزی: ۰۲۱-۸۸۶۲۰۸۵

FarmaSOS.com

**■ Conditions under which the Blind Spot Monitor system may not function correctly**

- The Blind Spot Monitor system may not detect vehicles correctly in the following conditions:
  - During bad weather such as heavy rain, fog, snow etc.
  - When ice or mud etc. is attached to the rear bumper
  - When driving on a road surface that is wet due to rain, standing water etc.
  - When there is a significant difference in speed between your vehicle and the vehicle that enters the detection area
  - When a vehicle is in the detection area from a stop and remains in the detection area as your vehicle accelerates
  - When driving up or down consecutive steep inclines, such as hills, a dip in the road etc.
  - When multiple vehicles approach with only a small gap between each vehicle
  - When vehicle lanes are wide, and the vehicle in the next lane is too far away from your vehicle
  - When the vehicle that enters the detection area is traveling at about the same speed as your vehicle
  - When there is a significant difference in height between your vehicle and the vehicle that enters the detection area
  - Directly after the BSM switch is set to on
- Instances of the Blind Spot Monitor unnecessarily detecting a vehicle and/or object may increase under the following conditions:
  - When there is only a short distance between your vehicle and a guardrail, wall etc.
  - When there is only a short distance between your vehicle and a following vehicle
  - When vehicle lanes are narrow and a vehicle driving 2 lanes across from your vehicle enters the detection area

**■ The outside rear view mirror indicators visibility**

When under strong sunlight, the outside rear view mirror indicator may be difficult to see.



### ■ When there is a malfunction in the system

If a system malfunction is detected due to any of the following reasons, warning messages will be displayed: (→P. 703)

- There is a malfunction with the sensors
- The sensors have become dirty
- The outside temperature is extremely high or low
- The sensor voltage has become abnormal

### ■ Certification for the BSM

► For vehicles sold in the U.S.A.

FCC ID: OAYBSDTX

This device complies with part 15 of the FCC Rules. Operation is subject to the following three conditions:

- (1) This device may not cause harmful interference.
- (2) This device must accept any interference received, including interference that may cause undesired operation.
- (3) This device may only work when the vehicle is in operation pursuant to § 15.252 (a) (4).

#### FCC WARNING

Changes or modifications not expressly approved by the party responsible for compliance could void the user's authority to operate the equipment.

► For vehicles sold in Canada

IC: 4135A-BSDTX

This device complies with the radio standards specification RSS-220 of Industry Canada. Operation is subject to the following two conditions:

- (1) This device may not cause harmful interference.
- (2) This device must accept any interference received, including interference that may cause undesired operation.

#### NOTE

During printing time of this user manual the approvals listed below are granted. Further countries may become available or actual certification identifiers may be subject to change or update.

#### WARNING

Changes or modifications not expressly approved by the party responsible for compliance could void the user's authority to operate the equipment.

## ⚠ CAUTION

### ■ Cautions regarding the use of the system

The driver is solely responsible for safe driving. Always drive safely, taking care to observe your surroundings.

The Blind Spot Monitor is a supplementary system which alerts the driver that a vehicle is present in the blind spot. Do not overly rely on the Blind Spot Monitor system. The system cannot judge if it is safe to change lanes, therefore over reliance could cause an accident resulting in death or serious injury. According to conditions, the system may not function correctly. Therefore the driver's own visual confirmation of safety is necessary.

### ■ Handling the radar sensor

One Blind Spot Monitor sensor is installed inside the left and right side of the vehicle rear bumper respectively. Observe the following to ensure the Blind Spot Monitor system can function correctly.

- Keep the sensor and its surrounding area on the bumper clean at all times.



- Do not subject the sensor or surrounding area on the bumper to a strong impact. If the sensor moves even slightly off position, the system may malfunction and vehicles that enter the detection area may not be detected. If the sensor or surrounding area is subject to a strong impact, always have the area inspected by your Lexus dealer.
- Do not disassemble the sensor.
- Do not attach accessories or stickers to the sensor or surrounding area on the bumper.
- Do not modify the sensor or surrounding area on the bumper.
- Do not paint the sensor or surrounding area on the bumper.

## Lexus night view\*

Lexus night view is a system which assists with nighttime driving.

Near-infrared rays are irradiated forward and an image converted from the irradiated light is shown on the Remote Touch screen. The image shows pedestrians, obstacles, and road conditions ahead of the vehicle, which are difficult to see at nighttime with the naked eye.

### Displaying the Lexus night view

- 1 Turn the engine switch to IGNITION ON mode.
- 2 The headlights turn on
- 3 Press the Lexus night view switch

The Lexus night view is displayed on the Remote Touch screen.

To return the screen to its previous state, press the switch again.

When the light sensor (→P. 193) determines that it is currently night time from the brightness of the surrounding area, the Lexus night view can be operated by pressing the Lexus night view switch while the headlights are on.



## The Lexus night view display

- When displaying on the “Main Display” (→P. 308)



- ① Lexus night view screen
- ② “Side Display” switching button

If this button is selected using the Remote Touch when the Lexus night view is being shown on the “Main Display”, the “Side Display” will change to a map display. (→P. 306)

If the button is selected again, the screen will return to its previous display.

- ③ Brightness adjustment button

The brightness of the display can be adjusted by selecting this button using Remote Touch.

Make sure to select the “OK” after adjusting the brightness.

“-”: Darker

“+”: Brighter



### ■ When displaying on the “Side Display”

When another screen is displayed on the “Main Display” while the Lexus night view is being shown on the “Main Display”, the Lexus night view screen will be displayed on the “Side Display”.



- ① Lexus night view screen
- ② “Main Display” switching button

Switches the Lexus night view from the “Side Display” to the “Main Display”.

### ■ Imaging range

The image is shown ranging from the tip of the low beam to the high beam.

- 
- If the vehicle speed is less than approximately 9 mph (15 km/h) when the Lexus night view is operating

An image will be displayed on the Lexus night view screen, but both the range and the distance of the projection will be limited as near-infrared rays are not being radiated outward.

- When the Lexus night view switch is pressed while the Lexus night view cannot be operated

Advice information will be displayed on the Lexus night view screen. Follow the displayed advice.

- If the Lexus night view switch is pressed at a time when the Lexus night view operation is not possible

Follow the advice displayed on the Remote Touch screen.

- When the shift lever is shifted to R while the Lexus night view is operating

The Lexus night view screen switches as follows.

“Main Display”: Switches to the rear view monitor system screen.

“Side Display”: The display blacks out and no image is displayed.

**⚠ CAUTION****■ Before using the Lexus night view**

Never depend on this system only.

Lexus night view is intended as a supplemental aid to help you see pedestrians and road conditions ahead of the vehicle. As there are limits to the system, do not rely solely on the system while in use, and drive safely while observing the following precautions.

**■ When using the Lexus night view**

Observe the following precautions.

Failure to do so may cause an accident resulting in death or serious injury.

- Never drive while looking at the Lexus night view screen only.
- Do not look continuously at the Lexus night view screen while driving. Pedestrians, objects etc. ahead of the vehicle may be overlooked by the system. The system should always be used as a supplemental aid only.
- Lexus night view is designed to help you see objects better when driving in darkness on a road with few curves. Do not use the Lexus night view in well-lit areas or on roads with many curves or slopes. There may be areas that cannot be displayed by the system due to the road conditions (curve size, gradient, etc.)
- Lexus night view may be unable to project some features at an appropriate level of brightness. Some or all parts of certain features may be dark or difficult to see. Do not rely solely on the Lexus night view, and drive carefully while checking the surroundings for safety, as you would with a normal vehicle. Also, the following features and conditions may not be displayed clearly.

Features that are difficult to display:

- Clothing of a pedestrian made of a certain kind of material (ex. leather jackets)
- The characters on signs and billboards
- The information on road signs

Conditions in which display is difficult:

- Unfavorable weather conditions such as rain, fog, snowfall, snow storms etc.
- There are large puddles of water on the road surface following rainfall
- The area of the front windshield in front of the camera is fogged up, dirty or icy
- The areas around the headlights are covered with ice, snow, mud etc.
- The battery voltage is remarkably low
- There are bright lights ahead of the vehicle

 NOTICE

■ **The near-infrared camera**

Follow these precautions to avoid damage to or incorrect operation of the Lexus night view.

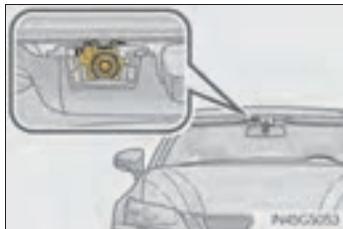

- Make sure the front windshield is kept clean.
- System performance may deteriorate if rain water, condensation or ice adheres to the camera. If you notice the inner lens of the camera is dirty, the garnish will have to be replaced. Consult your Lexus dealer.
- Do not subject the camera to strong impacts, or disassemble the camera.
- As the alignment of the camera has been very finely adjusted, do not change or remove the mounting.
- If the front windshield fogs up, defog the windshield using the front defroster.
- Do not dirty or scratch the camera lens.
- Night view may not function properly if an object is placed on the sensor, or anything that blocks the sensor is affixed to the windshield. تلفی

■ **The near-infrared light**

Follow these precautions to avoid damage to or incorrect operation of the Lexus night view system



- System performance may deteriorate if the areas around the headlights are dirty. Clean the vehicle if it is dirty.
- The near-infrared light irradiates strong energy not visible to the eyes. Do not stare at the light at close range for a long time.

## Winter driving tips

Carry out the necessary preparations and inspections before driving the vehicle in winter. Always drive the vehicle in a manner appropriate to the prevailing weather conditions.

### Preparation for winter

- Use fluids that are appropriate to the prevailing outside temperatures.
  - Engine oil
  - Engine coolant
  - Washer fluid
- Have a service technician inspect the condition of the battery.
- Have the vehicle fitted with four snow tires or purchase a set of tire chains for the rear tires.\*

Ensure that all tires are the specified size and brand, and that chains match the size of the tires.

\*: Tire chains cannot be mounted on the vehicles with front and rear tires of differing sizes and vehicles with LDH and 19-inch tires.

FarmaSOS.com



### Before driving the vehicle

Perform the following according to the driving conditions:

- Do not try to forcibly open a window or move a wiper that is frozen. Pour warm water over the frozen area to melt the ice. Wipe away the water immediately to prevent it from freezing.
- To ensure proper operation of the climate control system fan, remove any snow that has accumulated on the air inlet vents in front of the windshield.
- Check for and remove any excess ice or snow that may have accumulated on the exterior lights, vehicle's roof, chassis, around the tires or on the brakes.
- Remove any snow or mud from the bottom of your shoes before getting in the vehicle.

### When driving the vehicle

Accelerate the vehicle slowly, keep a safe distance between you and the vehicle ahead, and drive at a reduced speed suitable to road conditions.

### When parking the vehicle

Park the vehicle and move the shift lever to P without setting the parking brake. The parking brake may freeze up, preventing it from being released. If necessary, block the wheels to prevent inadvertent sliding or creeping.

## Selecting tire chains

- ▶ Vehicles with front and rear tires of the same size except for the vehicles with LDH and 19 inch tires

Use the correct tire chain size when mounting the tire chains.

Chain size is regulated for each tire size.

- ① Side chain  
(0.12 in. [3 mm] in diameter)
- ② Cross chain  
(0.16 in. [4 mm] in diameter)

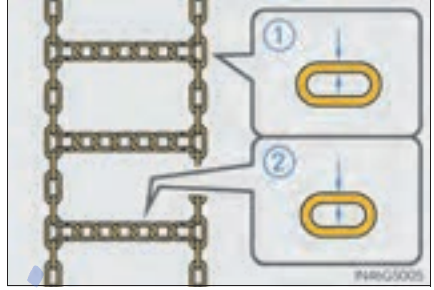

- ▶ Vehicles with front and rear tires of differing sizes and vehicles with LDH and 19-inch tires

Tire chains cannot be mounted.

Snow tires should be used instead.

تلفن شبانه روزی: ۰۲۱-۸۸۶۲۰۸۵

## Regulations on the use of tire chains

Regulations regarding the use of tire chains vary depending on location and type of road. Always check local regulations before installing chains.

## Shifting the windshield wiper position

If heavy snow or icy condition is expected, shift the rest position manually. Grip the hook section of the wiper arm firmly when shifting the wiper position.

### ■ To rest position

Raise the wiper in line with the windshield.

You can stand the wipers up for the rest position.

★: More than 3.9 in. (10 cm)

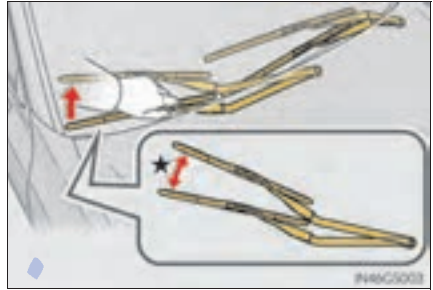

### ■ To retract position

Lower the wipers by pressing on the upper part of the hook section.

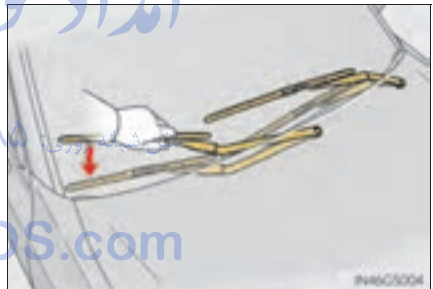

### ■ Tire chain installation

Observe the following precautions when installing and removing chains:

- Install and remove tire chains in a safe location.
- Install tire chains on the rear tires. Do not install tire chains on the front tires.
- Install tire chains on rear tires as tightly as possible. Retighten chains after driving 1/4—1/2 mile (0.5—1.0 km).
- Install tire chains following the instructions provided with the tire chains.

**⚠ CAUTION****■ Driving with snow tires**

Observe the following precautions to reduce the risk of accidents. Failure to do so may result in a loss of vehicle control and cause death or serious injury.

- Use tires of the specified size.
- Maintain the recommended level of air pressure.
- Do not drive in excess of 75 mph (120 km/h), regardless of the type of snow tires being used.
- Use snow tires on all, not just some wheels.
- Do not use LKA (Lane-Keeping Assist) system.

**■ Driving with tire chains (vehicles with front and rear tires of the same size except for the vehicles with LDH and 19 inch tires)**

Observe the following precautions to reduce the risk of accidents. Failure to do so may result in the vehicle being unable to be driven safely, and may cause death or serious injury.

- Do not drive in excess of the speed limit specified for the tire chains being used, or 30 mph (50 km/h), whichever is lower.
- Avoid driving on bumpy road surfaces or over potholes.
- Avoid sudden acceleration, abrupt steering, as well as sudden braking and shifting operation to engine braking.
- Slow down sufficiently before entering a curve to ensure that vehicle control is maintained.
- Do not use LKA (Lane-Keeping Assist) system.

 NOTICE**■ Repairing or replacing snow tires**

Request repairs or replacement of snow tires from Lexus dealers or legitimate tire retailers.

This is because the removal and attachment of snow tires affects the operation of the tire pressure warning valves and transmitters.

**■ Fitting tire chains (vehicles with front and rear tires of the same size except for the vehicles with LDH and 19 inch tires)**

The tire pressure warning valves and transmitters may not function correctly when tire chains are fitted.

**■ When standing the windshield wipers up**

Raise the wipers in line with the windshield. (→P. 301)

Failure to do so may result in damage to the wipers and/or the hood.

امداد خودرو فارما

تلفن شبانه روزی: ۰۲۱-۸۸۶۲۰۸۵

FarmaSOS.com

<b>5-1. Remote Touch screen</b>	
Remote Touch .....	306
Remote Touch screen .....	308
Set up screen .....	317
Voice command system .....	334
<b>5-2. Using the air conditioning system and defogger</b>	
Front automatic air conditioning system .....	345
Rear air conditioning system .....	360
Rear window and outside rear view mirror defoggers .....	365
Windshield wiper de-icer .....	366

تلفن شبانه روزی: ۰۲۱-۸۸۶۲۰۸۵

**FarmaSOS.com**

**5-3. Using the audio system**

Audio system type .....	367
Using the radio .....	390
Using the CD/DVD player .....	412
Playing an audio CD and MP3/WMA discs .....	414
Playing DVD video .....	420
CD/DVD player and DVD video disc information .....	432
Listening to Bluetooth® audio .....	444
Listening to a USB memory .....	454
Listening to an iPod .....	464
Optimal use of the audio/video system .....	474
Using the AUX port .....	476
Using the rear seat audio controls .....	477
Using the steering wheel audio switches .....	482

**5-4. Using the hands-free phone system (for cellular phone)**

Hands-free system (for cellular phone) .....	485
Using a Bluetooth® phone .....	493
Setting the hands-free system (for cellular phone) .....	512
Setting the Bluetooth® .....	535

**5-5. Using the interior lights**

Interior lights list .....	548
• Interior light .....	549
• Personal lights .....	549

**5-6. Using the storage features**

List of storage features .....	551
• Glove box .....	553
• Console box .....	554
• Cup holders .....	555
• Auxiliary boxes .....	557
Trunk features .....	558

**5-7. Other interior features**

Sun visors and vanity mirrors .....	561
Clock .....	562
Ashtrays .....	563
Power outlets .....	564
Heated steering wheel .....	566
Seat heaters/ seat ventilators .....	568
Armrest .....	571
Rear sunshade/ rear door sunshades .....	572
Trunk storage extension .....	575
Coat hooks .....	576
Assist grip .....	577
Utility hook .....	578
Garage door opener .....	579
Safety Connect .....	586

## Remote Touch

The Remote Touch can be used to operate the Remote Touch screens. Owners of models equipped with a navigation system should refer to the “Navigation System Owner’s Manual”.

The illustration below is for vehicles without navigation system.



① “^•v” button

Press this button to change map scale and scroll through lists.

② “COMPASS” button

Press this button to display the compass mode screen.

③ Remote Touch knob

Use this knob to move the cursor and select items on the screen.

Feedback force, pointer sound volume, on or off of selection sounds etc. can be changed.

④ “MENU” button

Press to display the “Menu” screen.



 CAUTION**■ When using the Remote Touch**

- Do not allow fingers, fingernails or hair to become caught in the Remote Touch as this may cause an injury.
- Be careful when selecting the Remote Touch in extreme temperatures as it may become very hot or cold due to the temperature inside the vehicle.

 NOTICE**■ To prevent damage to the Remote Touch**

- Do not allow the Remote Touch to come into contact with food, liquid, stickers or lit cigarettes as doing so may cause it to change color, emit a strange odor or stop functioning.
- Do not subject the Remote Touch to excessive pressure or strong impact as the knob may bend or break off.
- Do not allow coins, contact lenses or other such items to become caught in the Remote Touch as this may cause it to stop functioning.
- Items of clothing may rip if they become caught on the Remote Touch knob.
- If your hand or any object is on the Remote Touch knob when the engine switch is turned to ACCESSORY mode, the Remote Touch knob may not operate properly.

FarmaSOS.com

## Remote Touch screen

By using the Remote Touch, you can control the audio system and air conditioning system, and adjust the screen display etc.

Vehicles with a navigation system: Different information can be displayed on the left and right of the screen. The 8-inch display area on the left of the screen is called the “Main Display”, and the area to the right is called the “Side Display”. For details, refer to the “Navigation System Owner’s Manual”.

### “Menu” screen

- ▶ Vehicles without navigation system



- ▶ Vehicles with a navigation system



Switch	Page
"Destination"	Navigation System Owner's Manual
"Info/Apps" or "Info"	P. 314/Navigation System Owner's Manual
"Setup"	P. 317
"Radio"	P. 367, 390
"Media"	P. 367, 414
"Climate"	P. 345
"Phone"	P. 485
"Display"	P. 310

### Initial screen

If the engine switch is turned to ACCESSORY or IGNITION ON mode, the initial screen will be displayed for a few seconds as the system starts up.

Images shown on the initial screen can be changed to suit individual preferences. (→P. 322)



## Adjusting the display

The contrast and brightness of the screen display and the image the camera displays can be adjusted. (For information regarding audio/video screen adjustment: →P. 426)

- 1 Press the “MENU” button on the Remote Touch and select “Display” on the “Menu” screen.
- 2 Select “Map•Menu” / “Menu” or “Camera” to display the desired screen.

▶ Display screen (“Map•Menu” / “Menu”)

▶ Display screen (“Camera”)

If the map menu adjust screen does not appear, select “Map•Menu” / “Menu”.

If the camera adjust screen does not appear, select “Camera”.

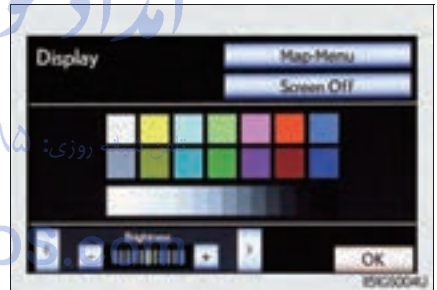

- 3 Select “<” or “>” to select the desired function (“Contrast” or “Brightness”) and then select the desired screen button to adjust contrast and brightness.

	“-”	“+”
“Contrast”	Weaker	Stronger
“Brightness”	Darker	Brighter

- 4 After adjusting the screen, select “OK”.

### ■ To avoid damaging the Remote Touch screen

Remove any dirt on the screen by wiping with a soft cloth. Do not use detergent.

### ■ When using the Remote Touch screen

- If the screen is cold, the display may be dark, or the system may seem to be operating slightly slower than normal.
- When the screen is viewed through polarized sunglasses, a rainbow pattern may appear on the screen due to optical characteristics of the screen. If this is disturbing, please operate the screen without polarized sunglasses.
- Dimmed screen buttons cannot be operated.

### ■ Changing between day mode and night mode

To display the screen in day mode, even with the headlight switch on, select "Day Mode" for brightness and contrast control.

If the screen is set to day mode with the headlight switch turned on, this condition is memorized even with the engine turned off.



The display condition is not changed to night mode even if the headlight switch is turned on when the vehicle is in a bright area such as daytime.

### ■ To turn off the display • ۲۱-۸۸۶۲۰۸۵ تلفن شبانه روزی:

The display goes off when "Screen Off" is selected. To turn the "Display" screen back on, select any button. The selected screen appears.

FarmaSOS.com

## Inputting letters and numbers/list screen operation

Letters and numbers can be input via the screen.

### ■ To input letters and numbers/symbols

Select the keys directly to enter letters, numbers or symbols.

#### ▶ Letters and numbers

#### ▶ Symbols

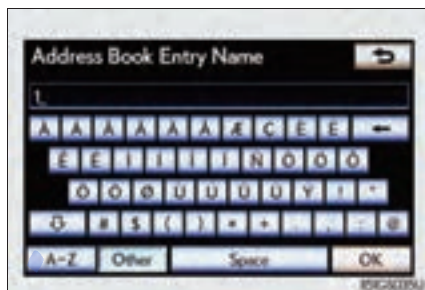
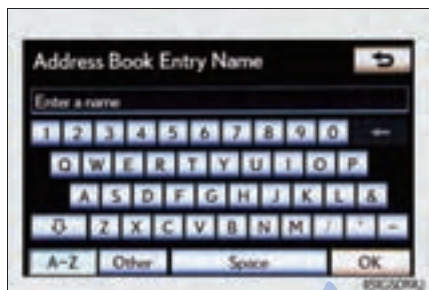

: Select to erase one character. Select and hold to continue erasing characters.

“A-Z”: To change letters and numbers

“Other”: To display symbols

: To enter in lower case

: To enter in upper case

## ■ Layout type

Keyboard layout can be changed. (→P. 322)

### ▶ “ABC” type

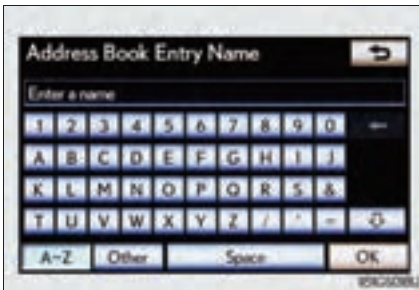

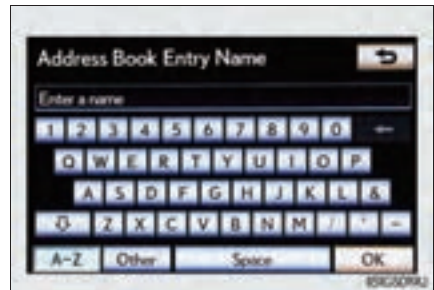

### ▶ “QWERTY” type



## ■ List screen operation

When a list is displayed, use the appropriate screen button to scroll through the list.





: Select to skip to the next or previous page. Select and hold  or  to scroll through the displayed list.



: This indicates the displayed screen's position.



: If  appears to the right of an item name, the complete name is too long for the display. Select  to scroll to the end of the name. Select  to move to the beginning of the name.

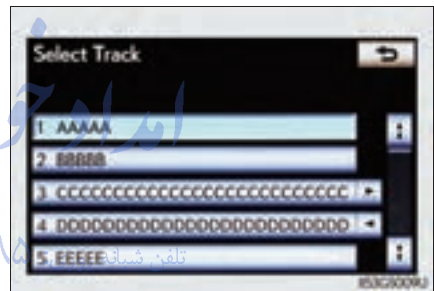

## ■ If you select

The display returns to the previous screen.

## Fuel consumption

Fuel consumption information from recent resets will be displayed.

Vehicles with a navigation system: The fuel consumption information can be displayed and operated on the “Side Display”. For details, refer to the “Navigation System Owner’s Manual”.

▶ Vehicles without navigation system

Press the “MENU” button on the Remote Touch, then select “Info” on the “Menu” screen.

▶ Vehicles with a navigation system

1 Press the “MENU” button on the Remote Touch, then select “Info/ Apps” on the “Menu” screen.

2 Select “Fuel consumption” on the “Information” screen.

### ■ Past record

If the “Past Record” screen does not appear, select “Past Record” on the “Trip Information” screen.

- 1 Updating the average fuel consumption data
- 2 Resetting the past record data
- 3 Best recorded fuel economy
- 4 Average
- 5 Current fuel economy
- 6 Previous fuel economy record



The average fuel consumption history is divided by color into past averages and the average fuel consumption since the last reset. Use the displayed average fuel consumption as a reference.

The image is an example only, and may vary slightly from actual conditions.



## ■ Trip information

If the “Trip Information” screen does not appear, select “Trip Information” on the “Past Record” screen.

- ① Resetting the consumption data
- ② Current fuel consumption per minute
- ③ Previous fuel consumption per minute
- ④ Average speed
- ⑤ Elapsed time
- ⑥ Cruising range



Average fuel consumption for the past 15 minutes is divided by color into past averages and averages attained since the engine switch was last turned to IGNITION-ON mode. Use the displayed average fuel consumption as a reference.

The image is an example only, and may vary slightly from actual conditions.

**■ Updating the past record data**

Update the average fuel consumption by selecting "Update" to measure the current fuel consumption again.

**■ Resetting the data**

The data can be deleted by selecting "Clear".

**■ Cruising range**

Displays the estimated maximum distance that can be driven with the quantity of fuel remaining.

This distance is computed based on your average fuel consumption.

As a result, the actual distance that can be driven may differ from that displayed.

امداد خودرو فارما

تلفن شبانه روزی: ۰۲۱-۸۸۸۶۲۰۸۵

FarmaSOS.com

## Set up screen

You can change the Remote Touch screen to your desired settings. Press the “MENU” button on the Remote Touch, then select “Setup” on the “Menu” screen.

Owners of models equipped with a navigation system should refer to the “Navigation System Owner’s Manual”.

▶ Vehicles without navigation system

▶ Vehicles with a navigation system



Switch	Page
“General”	P. 318/ Navigation System Owner’s Manual
“Voice”	P. 330/ Navigation System Owner’s Manual
“Navigation”	Navigation System Owner’s Manual
“Vehicle”	P. 331/ Navigation System Owner’s Manual
“Phone”	P. 332
“Bluetooth*”	P. 332
“Audio”	P. 333
“Other”	Navigation System Owner’s Manual

\*: Bluetooth is a registered trademark of Bluetooth SIG, Inc.

## General settings

This screen is used for language selection and the on/off settings of operation sounds and automatic screen change, etc.

Select "General" on the "Setup" screen.

- ① System time settings
- ② Selecting a language
- ③ Unit of measurement\*<sup>1</sup>
- ④ Selecting a button color
- ⑤ Selecting keyboard layout
- ⑥ Changing the startup image
- ⑦ Changing the screen off image
- ⑧ Auto screen change\*<sup>1</sup>
- ⑨ Selection sound on/off
- ⑩ Pointer sound on/off
- ⑪ Error sound on/off
- ⑫ Pointer sound volume settings
- ⑬ Setting a feedback force
- ⑭ Delete personal data
- ⑮ Software update\*<sup>2</sup>
- ⑯ Gracenote database update\*<sup>2</sup>

Select "Save" after changing settings.

\*<sup>1</sup>: Vehicles with a navigation system.

\*<sup>2</sup>: For details, contact your Lexus dealer.

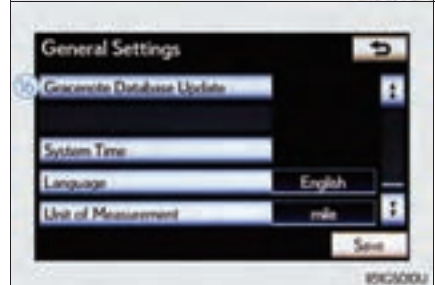
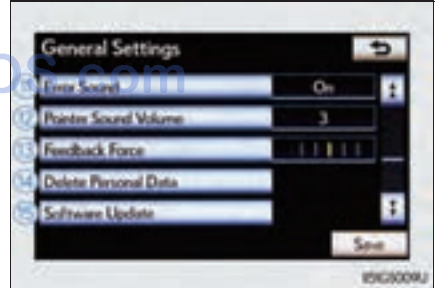
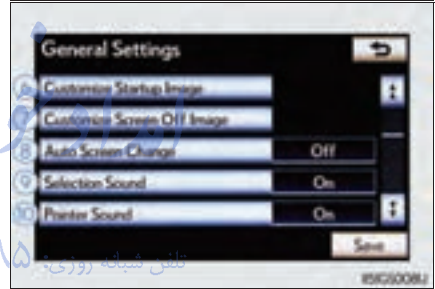

## ■ System time settings

Used for changing time zones and the on/off settings of daylight saving time.

- 1 Select "System Time" on the "General Settings" screen.
- 2 Select the items to be set.
  - ① Time zone
  - ② Daylight saving time

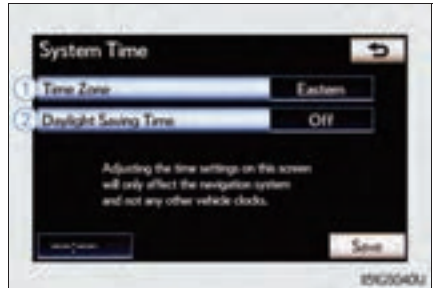

- 3 Select "Save".

### ● Time zone

A time zone can be selected and GMT can be set.

- 1 Select "Time Zone".

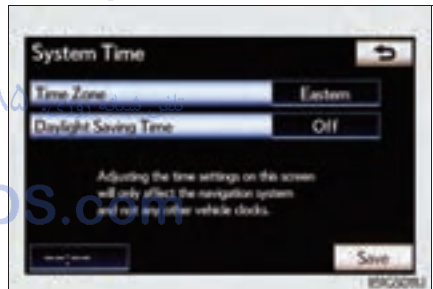

- 2 Select the desired time zone.



If “Other” is selected, the zone can be adjusted manually. Select “+” or “-” to adjust the time zone and then select “OK”.



- Daylight saving time

To select “On” or “Off” for daylight saving time.

- **Selecting a language**

The language can be changed.

- 1 Select “Language” on the “General Settings” screen.
- 2 Select the desired screen button.



- 3 Select “Yes”.

The previous screen will be displayed.

- 4 Select “Save”.

### ■ Unit of measurement (vehicles with a navigation system)

Distance unit can be changed.

This function is available only in English or Spanish. To change language, see "Selecting a language". (→P. 320)

- 1 Select "Unit of Measurement" on the "General Settings" screen.
- 2 Select "km" or "mile".

The previous screen will be displayed.

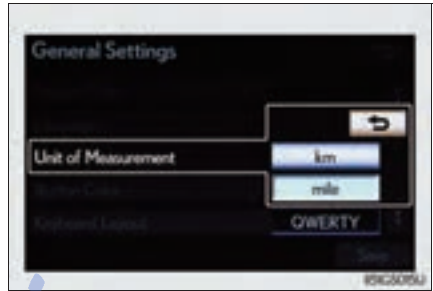

- 3 Select "Save".

### ■ Selecting a button color

The color of the screen buttons can be changed.

- 1 Select "Button Color" on the "General Settings" screen.
- 2 Select the desired screen button color.

The previous screen will be displayed.

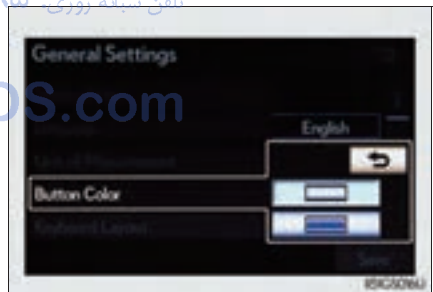

- 3 Select "Save".

### ■ Selecting a keyboard layout

Keyboard layout can be changed.

- 1 Select "Keyboard Layout" on the "General Settings" screen.
- 2 Select "ABC" or "QWERTY".

The previous screen will be displayed.

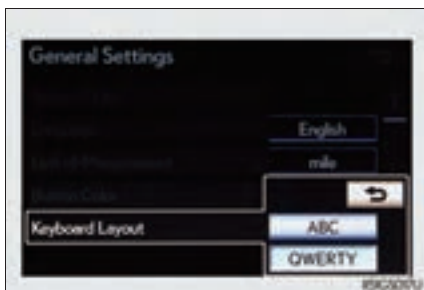

- 3 Select "Save".

### ■ Changing the startup image (vehicles without a navigation system)

An image can be copied from a USB memory and used as the startup image.

When saving the images to a USB memory, name the folder that the startup image is saved to "StartupImage". If these folder names are not used, the system cannot download the images. (The folder names are case sensitive.)

FarmaSOS.com



● Transferring data

- 1 Open the console box.

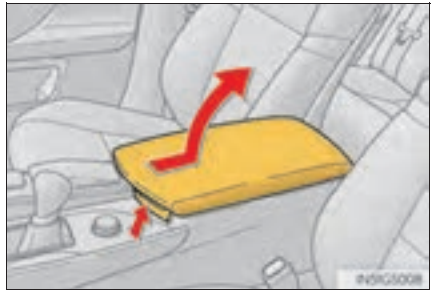

- 2 Open the cover and connect a USB memory.

Turn on the power of the USB memory if it is not turned on.

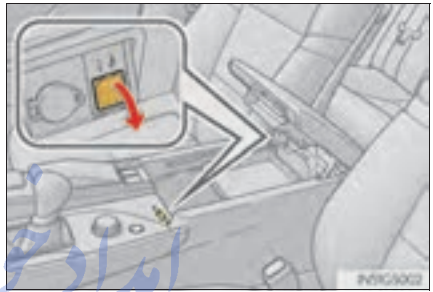

- 3 Close the console box.

- 4 Select "Customize Startup Image" on the "General Settings" screen.

- 5 Select "Transfer".

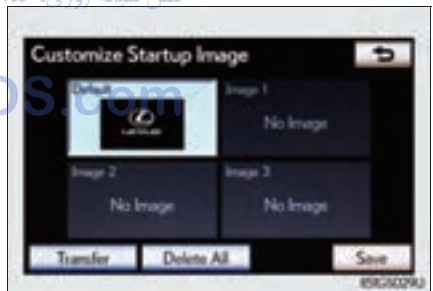

- 6 Select "Yes".

- Setting the startup image

- 1 Select "Customize Startup Image" on the "General Settings" screen.
- 2 Select the desired image.



- 3 Select "Save".

- Deleting transferred image

- 1 Select "Customize Startup Image" on the "General Settings" screen.
- 2 Select "Delete All".



- 3 Select "Yes".

## ■ Changing the screen off image

Select "Screen Off" on the "Display" screen to turn off the screen. An image can be copied from a USB memory and can be set to display when "Screen Off" is selected.

When saving the images to a USB memory, name the folder that the screen off image is saved to "DisplayOffImage". If these folder names are not used, the system cannot download the images. (The folder names are case sensitive.)

## ● Transferring data

- 1 Open the console box.

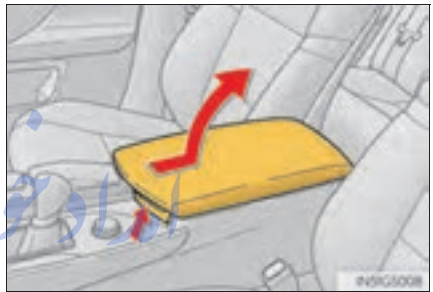

- 2 Open the cover and connect a USB memory.

Turn on the power of the USB memory if it is not turned on.



- 3 Close the console box.

- 4 Select "Customize Screen Off Image" on the "General Settings" screen.

- 5 Select "Transfer".



- 6 Select "Yes".

- Setting the screen off image

- 1 Select "Customize Screen Off Image" on the "General Settings" screen.

- 2 Select the desired image.



- 3 Select "Save".

- Deleting transferred images

- 1 Select "Customize Screen Off Image" on the "General Settings" screen.

- 2 Select "Delete All".



- 3 Select "Yes".

### ■ Pointer sound volume settings

The pointer sound volume can be adjusted.

- 1 Select "Pointer Sound Volume" on the "General settings" screen.
- 2 Select the desired button.

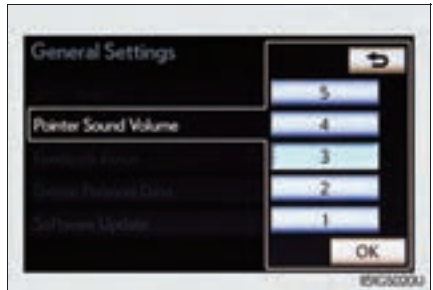

- 3 Select "OK", and then "Save".

### ■ Setting a feedback force

When the pointer moves close to a button, it will be automatically pulled onto that button. The strength of this pull can be adjusted.

- 1 Select "Feedback Force" on the "General settings" screen.
- 2 Select "+" or "-".



- 3 Select "OK", and then "Save".

## ■ Delete personal data

This function is not available while driving.

- 1 Select "Delete Personal Data" on the "General Settings" screen.
- 2 Select "Delete".

Check carefully beforehand, as data cannot be retrieved once deleted.

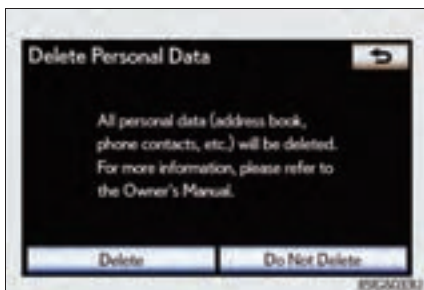

- 3 Select "Yes".

The following personal data can be deleted or returned to their default settings:

- Maintenance conditions\*
- Maintenance information off setting\*
- Address book\*
- Areas to avoid\*
- Previous points\*
- Route guidance\*
- Route trace\* تلفن شبانه روزی: ۰۲۱-۸۸۶۲۰۸۵
- Phonebook data
- Call history data
- Speed dial data
- Bluetooth® phone data
- Phone sound settings
- Phone display settings
- Message settings
- Audio setting
- Bluetooth® audio setting
- Startup image data
- Screen off image data

\*: Vehicles with a navigation system.

### ■ About startup or screen off images

- The images file extension is JPG or JPEG.
- The images file name, including the file extension, can be up to 32 characters.
- Image files of 10 MB or less can be saved.
- Up to 3 images can be downloaded.

امداد خودرو فارما

تلفن شبانه روزی: ۰۲۱-۸۸۸۶۲۰۸۵

FarmaSOS.com

## Voice settings

Voice guidance can be set.

Select "Voice" on the "Setup" screen.

- ① Select voice guidance volume
- ② Voice guidance on/off during route guidance\*
- ③ Voice guidance on/off during audio system is in use
- ④ Voice recognition prompt on/off

This setting can also be changed on the "Shortcut Menu" screen.

(→P. 342)

- ⑤ Restore default settings
- ⑥ Voice commands on/off when using the audio/video and air conditioning system
- ⑦ Voice guidance on/off when using the traffic information\*
- ⑧ Voice guidance on/off when using the XM NavWeather™\*

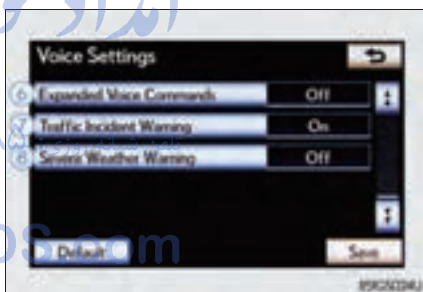
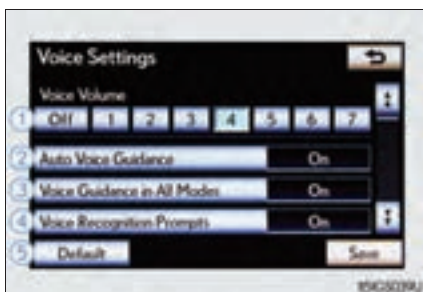

Make sure to save after changing settings.

\*: Vehicles with a navigation system.



## ■ Voice volume

The voice guidance volume can be adjusted or switched off.

- 1 Select "Voice" on the "Setup" screen.
- 2 Select the desired level.

Vehicle with a navigation system:

If voice guidance is not needed, select "Off" to disable the feature.

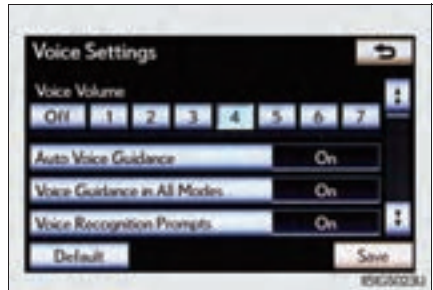

- 3 Select "Save".

## Vehicle settings

Select "Vehicle" on the "Setup" screen.

- 1 Maintenance information settings

Refer to "Navigation System Owner's Manual".

- 2 Vehicle customization

Detailed information: →P. 779

- 3 Setting up intuitive parking assist

Detailed information: →P. 246

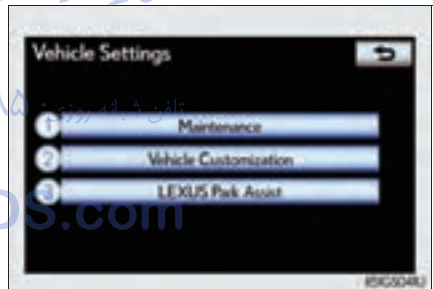

## Phone settings

Select "Phone" on the "Setup" screen.

- ① Phone sound settings  
Detailed information: →P. 513
- ② Phonebook settings  
Detailed information: →P. 514
- ③ Message settings  
Detailed information: →P. 528
- ④ Phone display settings  
Detailed information: →P. 532

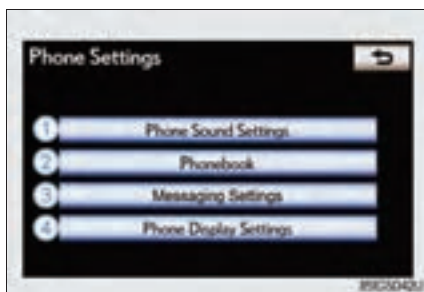

## Bluetooth® Settings

Select "Bluetooth\*" on the "Setup" screen.

- ① Registered devices  
Detailed information: →P. 536
- ② Selecting a Bluetooth® phone  
Detailed information: →P. 542
- ③ Selecting portable player  
Detailed information: →P. 543
- ④ Detailed Bluetooth® settings  
Detailed information: →P. 544

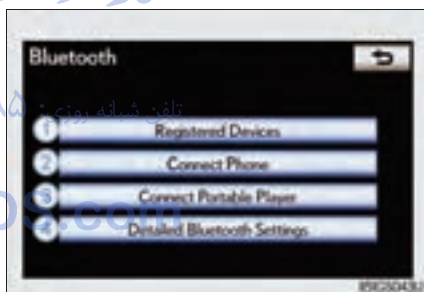

\*: Bluetooth is a registered trademark of Bluetooth SIG, Inc.

## Audio settings

Select "Audio" on the "Setup" screen.

① HD Radio™ system settings

Detailed information: →P. 394

② iPod settings

Detailed information: →P. 467

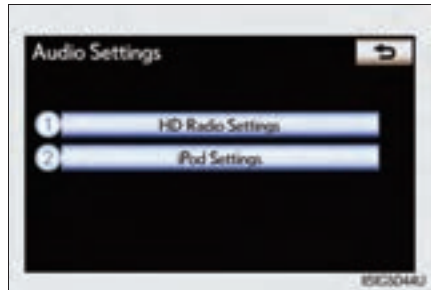

امداد خودرو فارما

تلفن شبانه روزی: ۰۲۱-۸۸۶۲۰۸۵

FarmaSOS.com

## Voice command system

The voice command system enables the navigation, audio/video, hands-free and air conditioning systems to be operated using voice commands.

For details of the navigation system, refer to the “Navigation System Owner’s Manual”.

### ◆ Talk switch

Press .

To cancel, press and hold the talk switch.

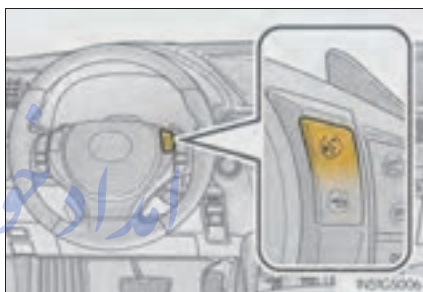

### ◆ Back switch

Press .

To return to the previous screen.

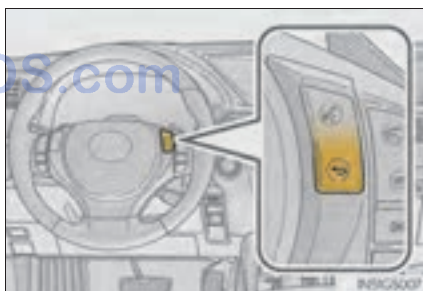

### ◆ Microphone

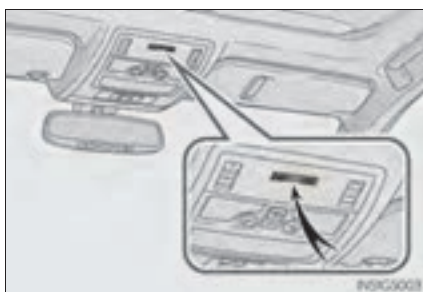

## Voice command system operation

### ■ Voice command system operation

1 Press .

After the “Shortcut Menu” screen has been displayed, voice guidance will commence.

Voice guidance for the voice command system can be skipped by pressing



2 After a beep sounds, say the command of your choice.

Voice commands are marked with



Some commonly used commands are displayed on the screen.

If you wish to display the commands displayed on the page in the background, perform one of the following:

- Say “Next page” or “Previous page”.
- Select “Next Pg.” or “Prev. Pg.”

If you wish to display the “Main Menu” screen when the “Shortcut Menu” screen is displayed, perform one of the following:

- Say “Main menu”.
- Select “Main Menu”.

To cancel, select “Cancel”, or press and hold .

Saying “Help” prompts voice guidance to offer examples of commands and operation methods.

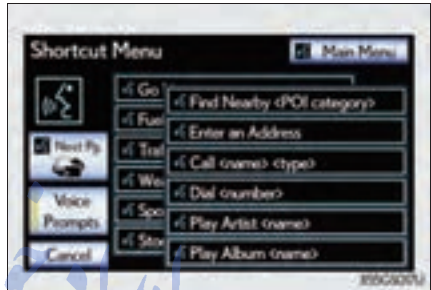

- 3** Say the command displayed on the screen.

If a desired outcome is not shown, or if no selections are available, perform one of the following to return to the previous screen:

- Say “Go back”.
- Select “Go Back”.
- Press .

To cancel, select “Cancel”, or press and hold .

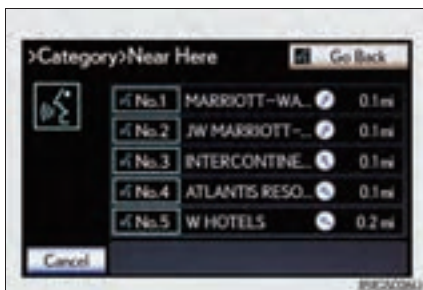

### ■ Voice command example (search for a track using artist name or album name)

- 1** Press .

“Play Artist <name>” and “Play Album <name>” are displayed in the “Shortcut Menu” screen.

- 2** Say “Play artist <name>” or “Play album <name>”.

Say the desired artist name or album name in the place of the “<”.

A confirmation screen will be displayed showing the recognition results. If multiple matching items are found, a selection screen will be displayed.

When “Play Artist <name>” is used to play music, the first track is selected randomly.

- 3** Say “Yes” or select “Yes”.



## Natural speech information (English only)

Due to natural language speech recognition technology, this system enables recognition of a command when spoken naturally. However, the system cannot recognize every variation of each command. In some situations, it is possible to omit the command for the procedure and directly state the desired operation. Not all voice commands are displayed in the short cut menu.

### ■ Expression examples for each function

Command	Expression examples
"Call <name> <type>"	Get me <Robert Brown>. I need to call <Robert Brown> at <Work> right away.
"Dial <number>"	Please dial the number <3334445555>. Ring <3334445555>.
"Play Artist <name>"	Play the artist <XXXXX>. I'd like to hear the band <XXXXX>.*
"Play Album <name>"	Play album <XXXXX>. Music from album <XXXXX>.*

\*: Say the desired artist name or album name in the place of the "<>".

Commands that are not displayed in the "Shortcut Menu" screen can be accessed from the main menu.

For example, to make an "International Call", say "Main menu" while the "Shortcut Menu" screen is being displayed. Then say "Use the phone" followed by saying the desired number, e.g. "123456789".

## Expanded voice commands

Selecting “On” next to “Expanded Voice Commands” on the “Voice Settings” screen enables voice command operation of the audio/video and air conditioning system. (→P. 330)

For more information on operations that can be controlled using expanded voice commands, refer to “Command list”. (→P. 339)

### ■ Voice command example (turn the audio system)

1 Press .

2 Say “Audio on”.

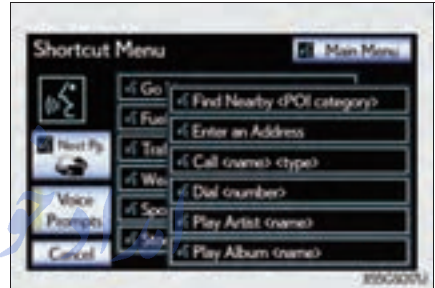

تلفن شبانه روزی: ۰۲۱-۸۸۶۲۰۸۵

FarmaSOS.com



## Command list

Recognizable voice commands and their actions are shown below.

- For devices that are not installed in the vehicle, the related commands will not be displayed in the “Shortcut Menu” screen. Also, according to conditions, other commands may not be displayed in the “Shortcut Menu” screen.
- Voice recognition language can be changed. (→P. 320)
- Commands that have a “O” in the “Shortcut Menu” column in the following table can be recognized from the “Shortcut Menu” screen. Commands that have a “–” in the Shortcut Menu column can only be recognized from the screen that they are displayed in.

### ■ Calling a phone (→P. 498)

Command	Action	Shortcut Menu
“Call <name> <type>”	Calls made by saying a name from the phonebook. For example: Say “Call John Smith”, “Call John Smith, mobile” etc.	O
“Dial <number>”	Calls made by saying the phone number. For example: Say “Dial 911”, “Dial 5556667777” etc.	O
“International Call” <sup>*1</sup>	Calls international numbers by saying the phone number.	–

<sup>\*1</sup>: To use this function, say “Main menu” and then “Use the phone” while the “Shortcut Menu” screen is being displayed.

### ■ Playing a music

Command	Action	Shortcut Menu
"Play Artist <name>"	Plays tracks by the selected artist. For example: Say "Play artist <XXXXXX>"*1	○
"Play Album <name>"	Plays tracks from the selected album. For example: Say "Play album <XXXXXX>"*1	○
"Play Song <name>"*2	Plays the selected track. For example: Say "Play song Summer-time", "Play song Concerto in A Major" etc.	-
"Play Playlist <name>"*2	Plays tracks from the selected playlist. For example: Say "Play playlist My Favorite Songs", "Play Playlist Classic Hits" etc.	-

\*1: Say the desired artist name or album name in the place of the "<>".

\*2: To use this function, say "Main menu" and then "Play music" while the "Shortcut menu" screen is being displayed. تلفن شبانه روزی: ۰۲۱-۸۵۰۰۰۰۰۰

## ■ Select audio mode

When expanded voice commands are turned "On". (→P. 330)

Command	Action	Shortcut Menu
"Radio"	Sets the audio mode to radio.	○
"AM"	Selects the AM band.	○
"FM"	Selects the FM band.	○
"Satellite radio"	Selects the satellite radio mode.	○
"Disc"	Selects the disc audio mode.	○
"Auxiliary"	Selects the auxiliary audio mode.	○
"Bluetooth* audio"	Selects the Bluetooth® audio mode.	○
"iPod"	Selects the iPod audio mode.	○
"USB audio"	Selects the USB audio mode.	○
"Audio on"	Turns the audio system on.	○
"Audio off"	Turns the audio system off.	○



\*: Bluetooth is a registered trademark of Bluetooth SIG, Inc.

## ■ Air conditioning system command

When expanded voice commands are turned "On". (→P. 330)

Command	Action	Shortcut Menu
"Automatic climate control"	Turns air conditioning system on and off.	○
"Warmer"	Turns temperature up.	○
"Cooler"	Turns temperature down.	○

### ■ Voice command system

- Commands that are not displayed in the “Shortcut Menu” screen can be operated from the “Main Menu” screen.
- If the system does not respond or the confirmation screen does not disappear, press  and try again.
- Voice guidance can be canceled by setting voice prompts to off. Use this setting when it is desirable to say a command immediately after pressing  and hearing a beep.

### ■ If a voice command cannot be recognized

- If a voice command cannot be recognized within 6 seconds, voice guidance will say “Pardon?” (“Command not recognized.” will be displayed on the screen) and voice command reception will restart.
- If a voice command cannot be recognized 2 consecutive times, the voice command guidance system will say “Paused. To restart voice recognition, push the talk switch. To cancel voice recognition, push and hold the talk switch.” Voice recognition will then be suspended. Select “Cancel” or “Go Back”, or press .

### ■ When selecting “Voice Prompts”

- The voice recognition prompt can be set to on or off. This setting can also be changed on the “Voice Settings” screen. (→P. 330)
- Voice recognition will be temporarily suspended. Press  again.

### ■ When using the microphone

- It is unnecessary to speak directly into the microphone when giving a command.
- Wait for the confirmation beep before speaking a command.
- Voice commands may not be recognized if:
  - Spoken too quickly.
  - Spoken at a low or high volume.
  - The roof or windows are open.
  - Passengers are talking while voice commands are spoken.
  - The air conditioning speed is set high.
  - The air conditioning vents are turned towards the microphone.
- In the following conditions, the system may not recognize the command properly and using voice commands may not be possible:
  - The command is incorrect or unclear. Note that certain words, accents or speech patterns may be difficult for the system to recognize.
  - There is excessive background noise, such as wind noise.

### ■ When searching for a track

- A USB memory or iPod must be connected to enable track searching and playback. (→P. 456, 466)
- When a USB memory or iPod is connected, recognition data is created so tracks can be searched using voice commands.
- Recognition data is updated under the following conditions:
  - When the USB memory or iPod data has changed.
  - When the voice recognition language is changed. (→P. 320)
- While the recognition data is being created or being updated, a track search cannot be performed using a voice command.
- While “Play Music” is displayed in the “Shortcut Menu” screen, say “Play Music” to display the music screen from which searching for a track using a voice command can be performed.
- When “Play Music” is dimmed in the “Shortcut Menu” screen, it is not possible to search for a track using a voice command. In this situation, reduce the amount of music data in the USB memory or iPod and update the recognition data to enable searching by voice command.

### ■ Natural speech information

- The “Use the Phone” and “Play Music” commands displayed on the “Shortcut Menu” screen can be operated using natural language speech recognition technology.
- If the command cannot be recognized completely, the command input screen will be displayed. (Search results will be shown based on the part of the command that was recognized.)

### ■ When turning the audio system or air conditioning system on

- Commands relating to operation of the audio/video and air conditioning systems can only be performed when the audio/video and air conditioning systems are turned on.
- Expanded voice commands can be recognized when the “Shortcut Menu” screen is displayed.

### ■ The Gracenote® media database

Music recognition technology and related data are provided by Gracenote®. Gracenote is the industry standard in music recognition technology and related content delivery. For more information visit [www.gracenote.com](http://www.gracenote.com).

تلفن شبانه روزی: ۰۲۱-۸۸۶۲۰۸۵

FarmaSOS.com

## Front automatic air conditioning system

Air outlets and fan speed are automatically adjusted according to the temperature setting.

Vehicles with a navigation system: The air conditioning system can be displayed and operated on the “Side Display”. For details, refer to the “Navigation System Owner’s Manual”.

Press the “MENU” button on the Remote Touch, then select “Climate” to display the air conditioning operation screen.

The display and button positions will differ depending on the type of the system.

امداد خودرو فارما

تلفن شبانه روزی: ۰۲۱-۸۸۶۲۰۸۵

FarmaSOS.com

- Without rear air conditioning system





► With rear air conditioning system



- ① Fan speed control
- ② Air flows to the feet and the windshield defogger operates.
- ③ Outside temperature
- ④ Right-hand front seat side temperature control
- ⑤ Right-hand front seat side temperature display
- ⑥ Front seat air outlet selector
- ⑦ Micro dust and pollen filter
- ⑧ DUAL/3-ZONE mode
- ⑨ Cooling and dehumidification function on/off
- ⑩ Left-hand front seat side temperature display
- ⑪ Left-hand front seat side temperature control
- ⑫ Windshield defogger
- ⑬ Outside air or recirculated mode
- ⑭ Air outlet selector
- ⑮ S-FLOW mode
- ⑯ Off
- ⑰ Automatic mode
- ⑱ Left-hand front seat side air outlet selector
- ⑲ Rear air conditioning operation screen
- ⑳ Right-hand front seat side air outlet selector

تلفن شبانه روزی: ۰۲۱-۸۸۶۲۰۸۵

FarmaSOS.com

## Using the speech command system

Press  to operate the speech command system. (→P. 334/"Navigation System Owner's Manual")

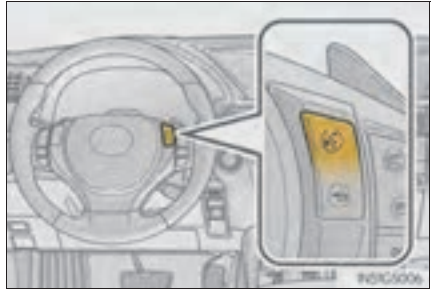

## Using the automatic air conditioning system

**1** Press .



The dehumidification function begins to operate. Air outlets and fan speed are automatically adjusted according to the temperature setting and humidity.

**2** Press  to switch to automatic air intake mode.



The air conditioning system automatically switches between outside air and recirculated air modes.

**3** Press “^” on  to increase the temperature and “v” to decrease the temperature.

### ▶ Without rear air conditioning system

When  is selected (the indicator on  is on) or the passenger's side temperature control button is pressed, the temperature for the driver and passenger seats can be adjusted separately.

### ▶ With rear air conditioning system

When  is selected (the indicator on  is on) or the passenger's side temperature control button is pressed, the temperature for the driver's, front passenger's and rear seats (→P. 360) can be adjusted separately.

Air outlets and fan speed for the driver and passenger seats may be adjusted separately depending on the temperature setting.

## Adjusting the settings manually

- Without rear air conditioning system

**1** To adjust the fan speed, select “^” on  to increase the fan speed and “v” to decrease the fan speed on the operation screen.

Press  to turn the fan off.

**2** To adjust the temperature setting, press “^” on  to increase the temperature and “v” to decrease the temperature.

When **DUAL** is selected (the indicator on **DUAL** is on) or the passenger's side temperature control button is pressed, the temperature for the driver and passenger seats can be adjusted separately.

**3** To change the air outlets, select an air outlet switch on the operation screen.





► With rear air conditioning system

- 1** To adjust the fan speed, select “^” on  to increase the fan speed and “v” to decrease the fan speed on the operation screen.

Press  to turn the fan off.

- 2** To adjust the temperature setting, press “^” on  to increase the temperature and “v” to decrease the temperature.

The air conditioning system switches between individual and simultaneous modes each time  is selected.

When  is selected (the indicator on  is on) or the passenger's side temperature control button is pressed, the temperature for the driver's, front passenger's and rear seats (→P. 360) can be adjusted separately.

- 3** To change the air outlets, select an air outlet switch on the operation screen.

- ① Left-hand front seat
- ② Right-hand front seat

Different air outlets for the driver and front passenger seats can be chosen.



## Defogging the windshield

Press .

The dehumidification function operates and fan speed increases.

Set the outside/recirculated air mode button to outside air mode if the recirculated air mode is used. (It may switch automatically.)

To defog the windshield and the side windows early, turn the air flow and temperature up.

To return to the previous mode, press

 again when the windshield is defogged.



## Air outlets and air flow

Upper body

\*: In "AUTO" mode, air may flow to the feet as well as to the body to prevent your feet from getting sweaty.

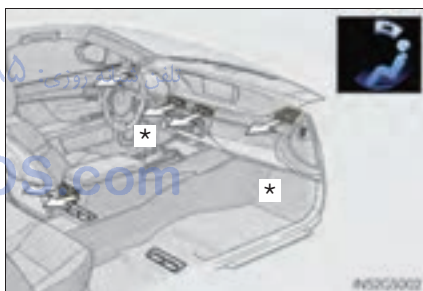

Upper body and feet

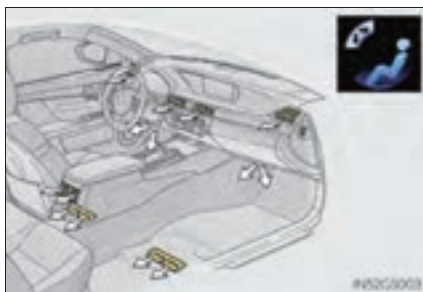

## Feet

- \*: When the warming function is operating, air flows to the upper body as well to warm the upper body effectively.

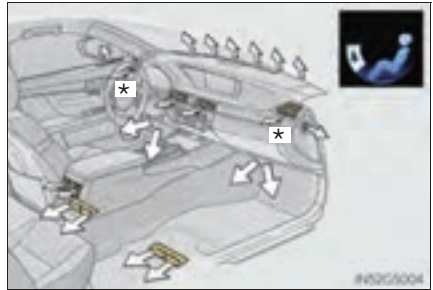

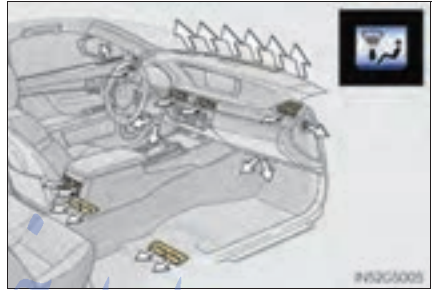

## Feet and windshield



## Switching between outside air and recirculated air modes

Press  .

The mode switches among  (recirculated air mode), automatic and  (outside air mode) modes each time the button is pressed.

When the system is switched to automatic mode, the air conditioning system operates automatically.

## Changing the rear seat settings (with rear air conditioning system)



### ■ Using the automatic mode

1 Select .

2 Select **REAR AUTO**.



The air conditioning system will operate, and air outlets and speed will be set automatically.



3 Select  to increase the temperature and  to decrease the temperature.

### ■ Adjusting the temperature setting

1 Select .

2 Select  (increase) or  (decrease) on the operation screen.

The air conditioning system switches between individual and simultaneous modes each time **3-ZONE** is selected.





### ■ Disabling the switches on the rear armrest.

Select .



### Micro dust and pollen filter button

Operates micro dust and pollen filter on/off.

Outside air mode switches to  (recirculated air) mode. Pollen is removed from the air and the air flows to the upper part of the body.

Usually the system will turn off automatically after approximately 1 to 3 minutes.



### S-FLOW mode button

Operates S-FLOW mode on/off.

When the S-FLOW switch is pressed, the airflow changes as follows.

Without rear air conditioning system:  
Air flows to the front seats only.

With rear air conditioning system: Air flows to the front seats only, and if the passenger seat is unoccupied, the set temperature, outside humidity and temperature inside the cabin are assessed, and air flows to the driver seat only.



## Adjusting the position of and opening and closing the air outlets

### ■ Front center outlets and front side outlets

- ① Direct air flow to the left or right, up or down.
- ② Turn the knob to open or close the vent.

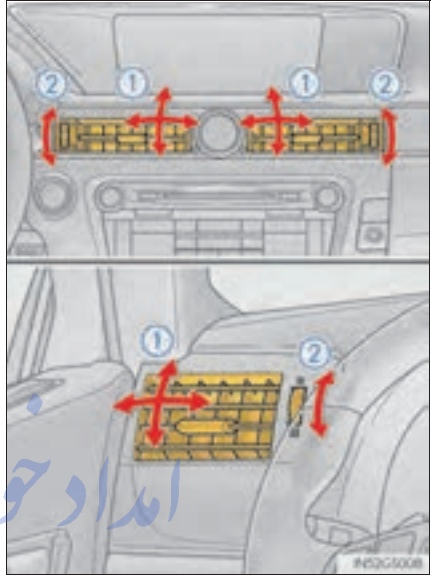

### ■ Rear seat outlets تلفن شبانه روزی: ۰۸۵-۸۸۶۲۰۲۱

- ① Direct air flow to the left or right, up or down.
- ② Turn the knob to open or close the vent.



### ■ Using automatic mode



Fan speed is adjusted automatically according to the temperature setting and the ambient conditions.

Therefore, the fan may stop for a while until warm or cool air is ready to flow immediately after  is pressed.

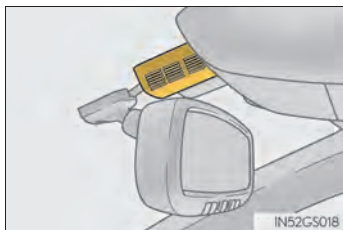

### ■ Humidity sensor

A sensor, which detects humidity inside the vehicle and the temperature of the windshield, is provided to detect fog on the front windscreen. Due to the sensor, when automatic mode is set the air conditioning may make the following controls:



- Changing the amount of air flow
- Changing the amount of air introduced from outside when in outside air mode with the air vents in the  position
- Changing the settings of the air vents to  when the  is set

### ■ Fogging up of the windows

- The windows will easily fog up when the humidity in the vehicle is high. Selecting  on will dehumidify the air from the outlets and defog the windshield effectively.
- If you turn  off, the windows may fog up more easily.
- The windows may fog up if the recirculated air mode is used.

### ■ Outside/recirculated air mode

- When driving on dusty roads such as tunnels or in heavy traffic, set the outside/recirculated air mode button to the recirculated air mode. This is effective in preventing outside air from entering the vehicle interior. During cooling operation, setting the recirculated air mode will also cool the vehicle interior effectively.
- Outside/recirculated air mode may automatically switch depending on the temperature setting or the inside temperature.

■ **When the outside temperature exceeds 75°F (24°C) and the air conditioning system is on**



- In order to reduce the air conditioning power consumption, the air conditioning system may switch to recirculated air mode automatically. This may also reduce fuel consumption.
- Recirculated air mode is selected as a default mode when the engine switch is turned on.
- It is possible to switch to outside air mode at any time by pressing .

■ **Automatic mode for air intake control**

In automatic mode, the system detects exhaust gas and other pollutants and automatically switches between outside air and recirculated air modes.

When the dehumidification function is off, and the fan is operating, turning automatic mode on will activate the dehumidification function.

■ **Micro dust and pollen filter**

- In order to prevent the windshield from fogging up when the outside air is cold, the following may occur:
  - Outside air mode does not switch to  (recirculated air) mode.
  - The dehumidification function operates.
  - The operation cancels after approximately 1 minute.
- In rainy weather, the windows may fog up. Press .
- In extremely humid weather, the windows may fog up.
- The pollens are filtered out even if the micro dust and pollen filter is turned off.

■ **When the outside temperature falls to nearly 32°F (0°C)**

The dehumidification function may not operate even when  is selected.

### ■ Air conditioning odors

- During use, various odors from inside and outside the vehicle may enter into and accumulate in the air conditioning system. This may then cause odor to be emitted from the vents.
- To reduce potential odors from occurring:
  - It is recommended that the air conditioning system be set to outside air mode prior to turning the vehicle off.
  - The start timing of the blower may be delayed for a short period of time immediately after the air conditioning system is started in automatic mode.

### ■ Air conditioning filter

→P. 644

### CAUTION

#### ■ To prevent the windshield from fogging up

Do not use  during cool air operation in extremely humid weather. The difference between the temperature of the outside air and that of the windshield can cause the outer surface of the windshield to fog up, blocking your vision.

### NOTICE

تلفن شماره روزی: ۰۲۱-۸۸۶۲۰۸۵

#### ■ To prevent battery discharge

Do not leave the air conditioning system on longer than necessary when the engine is stopped.

## Rear air conditioning system \*

Air outlets and fan speed are automatically adjusted according to the temperature setting.



- |                           |                       |
|---------------------------|-----------------------|
| ① Button lock display     | ⑤ Air outlet selector |
| ② Air outlet mode display | ⑥ Off                 |
| ③ Temperature display     | ⑦ Automatic mode      |
| ④ Temperature control     |                       |

## Using automatic air conditioning system

- 1 Press **AUTO**.

The air conditioning system will operate, and air outlets and fan speed will be adjusted automatically.

“AUTO” will be displayed on the control panel.

- 2 Press “^” on  to increase the temperature and “v” to decrease the temperature.

امداد خودرو فارما

تلفن شبانه روزی: ۰۲۱-۸۸۶۲۰۸۵

FarmaSOS.com

## Adjusting the settings manually

### ■ Adjusting the temperature setting

Press “^” on  to increase the temperature and “v” to decrease the temperature.

### ■ Changing the air outlets

Press .

The air outlets change as follows each time  is pressed.

Air flows as shown below according to the mode selected.

Upper body

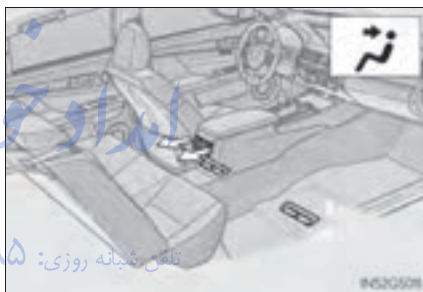

Upper body and feet

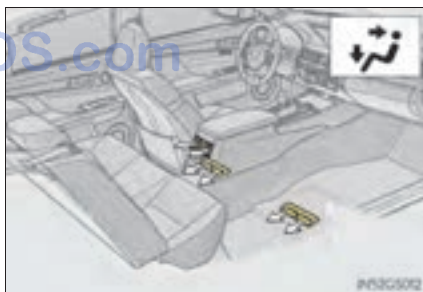



Feet

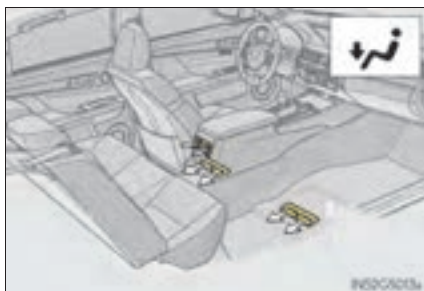

### Adjusting the position of and opening and closing the air outlets (Rear center outlets)

- ① Direct air flow to the left or right, up or down.
- ② Turn the knob to open or close the vent.



تلفن شبانه روزی: ۰۲۱-۸۸۶۲۰۸۵

FarmaSOS.com

### ■ Button lock function

To prevent inadvertent operation, the buttons on the rear armrest can be locked. Press **MODE** until you hear a beep to lock the buttons. Pressing **MODE** again until you hear a beep will release the lock.

The indicator appears on the display when the buttons are locked.



### ■ Rear control panel illumination off function

Control panel illumination on the rear armrest can be turned off. Press **PWR** until you hear a beep to turn the illumination off. Pressing **PWR** again until you hear a beep will turn the illumination on.



انداز خودرو فارما



### NOTICE

#### ■ To prevent battery discharge

Do not leave the air conditioning system on longer than necessary when the engine is off.

تلفن شبانه روزی: +۹۰ ۲۱-۸۸۶۲۰۸۵

FarmaSOS.com

## Rear window and outside rear view mirror defoggers

These features are used to defog the rear window, and to remove rain-drops, dew and frost from the outside rear view mirrors.

### On/off

The defoggers will automatically turn off after 15 to 60 minutes. The operation time changes according to the ambient temperature and vehicle speed.



### ■ Operating conditions

The engine switch must be in the IGNITION ON mode.

### ▲ CAUTION

تلفن شبانه روزی: ۰۲۱-۸۸۶۲۰۸۵

### ■ When the outside rear view mirror defoggers are on

Do not touch the rear view mirror surfaces, as they can become very hot and burn you.

### ▲ NOTICE

### ■ To prevent battery discharge

Turn the defoggers off when the engine is off.



## Windshield wiper de-icer\*

This feature is used to prevent ice from building up on the windshield and wiper blades.

- 1 Press the "MENU" button on the Remote Touch. (→P. 306)
- 2 Select "Climate" on the "Menu" screen.



- 3 ON/OFF

Select  to turn on the windshield wiper de-icer. The windshield wiper de-icer will automatically turn off after approximately 15 minutes. Selecting  again also turns the de-icer off.



### ■ Operating conditions

The engine switch must be in the IGNITION ON mode.

### ⚠ CAUTION

#### ■ When the windshield wiper de-icer is on

Do not touch the glass at the lower part of the windshield or to the side of the front pillars as the surfaces can become very hot and burn you.

## Audio system type

### CD and DVD player with AM/FM radio

**Vehicles with a navigation system:** The audio functions can be displayed and operated on the “Side Display”. For details, refer to the “Navigation System Owner’s Manual”.

- ▶ Using the instrument panel

Press the “RADIO” or “MEDIA” button to display the audio control screen.

- ▶ Using the Remote Touch

Press the “MENU” button on the Remote Touch, select “RADIO” or “MEDIA” and select each tab to display the audio control screen.

امداد خودرو فارما

تلفن شبانه روزی: ۰۲۱-۸۸۶۲۰۸۵

FarmaSOS.com



Title	Page
Using the radio	P. 390
Using the CD/DVD player	P. 412
Playing an audio CD and MP3/WMA discs	P. 414
Playing DVD video	P. 420
CD/DVD player and DVD video disc information	P. 432
Listening to Bluetooth® audio	P. 444
Listening to a USB memory	P. 454
Listening to an iPod	P. 464
Optimal use of the audio/video system	P. 474
Using the AUX port	P. 476
Using the steering wheel audio switches	P. 482

## Using the voice command system

Press  to operate the voice command system. (→P. 334/“Navigation System Owner’s Manual”)

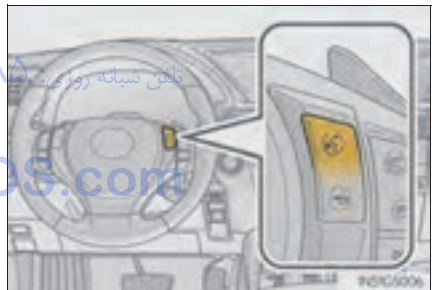



### ■ Using cellular phones

Interference may be heard through the audio system's speakers if a cellular phone is being used inside or close to the vehicle while the audio system is operating.

### ■ When using the Remote Touch screen

Dimmed screen buttons cannot be operated.

### ■ Tab

Select  or , located either side of the screen tabs, to display tabs from the previous or next page.

### ■ About Dolby

Manufactured under license from Dolby Laboratories. Dolby and the double-D symbol are trademarks of Dolby Laboratories.

## CAUTION

### ■ For vehicles sold in the U.S.A. and Canada

#### ● Part 15 of the FCC Rules

FCC Warning:

Changes or modifications not expressly approved by the party responsible for compliance could void the user's authority to operate the equipment.

#### ● Laser products

- USE OF CONTROL OR ADJUSTMENT OR PERFORMANCE OF PROCEDURES OTHER THAN THOSE SPECIFIED HEREIN MAY RESULT IN HAZARDOUS RADIATION EXPOSURE.
- THE USE OF OPTICAL INSTRUMENTS WITH THIS PRODUCT WILL INCREASE EYE HAZARD.

## NOTICE

### ■ To prevent battery discharge

Do not leave the audio system on longer than necessary when the engine is off.

### ■ To avoid damaging the audio system

Take care not to spill drinks or other fluids on the audio system.



## ■ Open source license

This product uses the following open source software.

### ● T-Kernel

This Product uses the Source Code of T-Kernel under T-License granted by the T-Engine Forum ([www.t-engine.org](http://www.t-engine.org)).

### ● C Library

This product includes software developed by the University of California, Berkeley and its contributors. This product includes software developed by the University of California, Lawrence Berkeley Laboratory.

Copyright © 1982, 1985, 1993 The Regents of the University of California. All rights reserved.

Copyright © 1982, 1986, 1993 The Regents of the University of California. All rights reserved.

Copyright © 1982, 1986, 1989, 1993 The Regents of the University of California. All rights reserved.

© UNIX System Laboratories, Inc. All or some portions of this file are derived from material licensed to the University of California by American Telephone and Telegraph Co. or Unix System Laboratories, Inc. and are reproduced herein with the permission of UNIX System Laboratories, Inc.

Copyright © 1982, 1986, 1991, 1993, 1994 The Regents of the University of California. All rights reserved.

© UNIX System Laboratories, Inc. All or some portions of this file are derived from material licensed to the University of California by American Telephone and Telegraph Co. or Unix System Laboratories, Inc. and are reproduced herein with the permission of UNIX System Laboratories, Inc.

Copyright © 1983, 1990, 1993 The Regents of the University of California. All rights reserved.

© UNIX System Laboratories, Inc. All or some portions of this file are derived from material licensed to the University of California by American Telephone and Telegraph Co. or Unix System Laboratories, Inc. and are reproduced herein with the permission of UNIX System Laboratories, Inc.

Copyright © 1983, 1993 The Regents of the University of California. All rights reserved.

Copyright © 1987, 1991, 1993 The Regents of the University of California. All rights reserved.

Copyright © 1987, 1993 The Regents of the University of California. All rights reserved.

Copyright © 1988 Regents of the University of California. All rights reserved.

Copyright © 1988 University of Utah.

Copyright © 1992, 1993 The Regents of the University of California. All rights reserved. This code is derived from software contributed to Berkeley by the Systems Programming Group of the University of Utah Computer Science Department and Ralph Campbell.

Copyright © 1988, 1993 The Regents of the University of California. All rights reserved.

Copyright © 1988, 1993 The Regents of the University of California. All rights reserved. This code is derived from software contributed to Berkeley by Arthur David Olson of the National Cancer Institute.

Copyright © 1989 The Regents of the University of California. All rights reserved.

Copyright © 1989 The Regents of the University of California. All rights reserved.

© UNIX System Laboratories, Inc. All or some portions of this file are derived from material licensed to the University of California by American Telephone and Telegraph Co. or Unix System Laboratories, Inc. and are reproduced herein with the permission of UNIX System Laboratories, Inc.

Copyright © 1989, 1993 The Regents of the University of California. All rights reserved.

Copyright © 1989, 1993 The Regents of the University of California. All rights reserved.

© UNIX System Laboratories, Inc. All or some portions of this file are derived from material licensed to the University of California by American Telephone and Telegraph Co. or Unix System Laboratories, Inc. and are reproduced herein with the permission of UNIX System Laboratories, Inc.

Copyright © 1990, 1993 The Regents of the University of California. All rights reserved.

This code is derived from software contributed to Berkeley by Chris Torek.

Copyright © 1991, 1993 The Regents of the University of California. All rights reserved.

Copyright © 1991, 1993 The Regents of the University of California. All rights reserved.

This code is derived from software contributed to Berkeley by Berkeley Software Design, Inc.

Copyright © 1992, 1993 The Regents of the University of California. All rights reserved.

Copyright © 1992, 1993 The Regents of the University of California. All rights reserved.

This code is derived from software contributed to Berkeley by Ralph Campbell.

Copyright © 1992, 1993 The Regents of the University of California. All rights reserved.

© UNIX System Laboratories, Inc. All or some portions of this file are derived from material licensed to the University of California by American Telephone and Telegraph Co. or Unix System Laboratories, Inc. and are reproduced herein with the permission of UNIX System Laboratories, Inc.

Copyright © 1992, 1993 The Regents of the University of California. All rights reserved.

This software was developed by the Computer Systems Engineering group at Lawrence Berkeley Laboratory under DARPA contract BG 91-66 and contributed to Berkeley. All advertising materials mentioning features or use of this software must display the following acknowledgement: This product includes software developed by the University of California, Lawrence Berkeley Laboratory.

Copyright © 1992, 1993 The Regents of the University of California. All rights reserved.

This code is derived from software contributed to Berkeley by Ralph Campbell. This file is derived from the MIPS RISC Architecture book by Gerry Kane.

Copyright © 1993 The Regents of the University of California. All rights reserved.

Copyright © 1994 The Regents of the University of California. All rights reserved.

This code is derived from software contributed to Berkeley by Andrew Hume of AT&T Bell Laboratories.

Redistribution and use in source and binary forms, with or without modification, are permitted provided that the following conditions are met:

1. Redistributions of source code must retain the above copyright notice, this list of conditions and the following disclaimer.
2. Redistributions in binary form must reproduce the above copyright notice, this list of conditions and the following disclaimer in the documentation and/or other materials provided with the distribution.
3. All advertising materials mentioning features or use of this software must display the following acknowledgement: This product includes software developed by the University of California, Berkeley and its contributors.
4. Neither the name of the University nor the names of its contributors may be used to endorse or promote products derived from this software without specific prior written permission.

THIS SOFTWARE IS PROVIDED BY THE REGENTS AND CONTRIBUTORS "AS IS" AND ANY EXPRESS OR IMPLIED WARRANTIES, INCLUDING, BUT NOT LIMITED TO, THE IMPLIED WARRANTIES OF MERCHANTABILITY AND FITNESS FOR A PARTICULAR PURPOSE ARE DISCLAIMED. IN NO EVENT SHALL THE REGENTS OR CONTRIBUTORS BE LIABLE FOR ANY DIRECT, INDIRECT, INCIDENTAL, SPECIAL, EXEMPLARY, OR CONSEQUENTIAL DAMAGES (INCLUDING, BUT NOT LIMITED TO, PROCUREMENT OF SUBSTITUTE GOODS OR SERVICES; LOSS OF USE, DATA, OR PROFITS; OR BUSINESS INTERRUPTION) HOWEVER CAUSED AND ON ANY THEORY OF LIABILITY, WHETHER IN CONTRACT, STRICT LIABILITY, OR TORT (INCLUDING NEGLIGENCE OR OTHERWISE) ARISING IN ANY WAY OUT OF THE USE OF THIS SOFTWARE, EVEN IF ADVISED OF THE POSSIBILITY OF SUCH DAMAGE.

Copyright © 1982, 1986 Regents of the University of California. All rights reserved.

Copyright © 1983, 1990, 1993 The Regents of the University of California. All rights reserved.

Redistribution and use in source and binary forms, with or without modification, are permitted provided that the following conditions are met:

1. Redistributions of source code must retain the above copyright notice, this list of conditions and the following disclaimer.
2. Redistributions in binary form must reproduce the above copyright notice, this list of conditions and the following disclaimer in the documentation and/or other materials provided with the distribution. تلفن شبانه روزی: ۰۲۱-۷۶۸۴۱۰۰۰
3. All advertising materials mentioning features or use of this software must display the following acknowledgement: This product includes software developed by the University of California, Berkeley and its contributors.
4. Neither the name of the University nor the names of its contributors may be used to endorse or promote products derived from this software without specific prior written permission.

THIS SOFTWARE IS PROVIDED BY THE REGENTS AND CONTRIBUTORS "AS IS" AND ANY EXPRESS OR IMPLIED WARRANTIES, INCLUDING, BUT NOT LIMITED TO, THE IMPLIED WARRANTIES OF MERCHANTABILITY AND FITNESS FOR A PARTICULAR PURPOSE ARE DISCLAIMED. IN NO EVENT SHALL THE REGENTS OR CONTRIBUTORS BE LIABLE FOR ANY DIRECT, INDIRECT, INCIDENTAL, SPECIAL, EXEMPLARY, OR CONSEQUENTIAL DAMAGES (INCLUDING, BUT NOT LIMITED TO, PROCUREMENT OF SUBSTITUTE GOODS OR SERVICES; LOSS OF USE, DATA, OR PROFITS; OR BUSINESS INTERRUPTION) HOWEVER CAUSED AND ON ANY THEORY OF LIABILITY, WHETHER IN CONTRACT, STRICT LIABILITY, OR TORT (INCLUDING NEGLIGENCE OR OTHERWISE) ARISING IN ANY WAY OUT OF THE USE OF THIS SOFTWARE, EVEN IF ADVISED OF THE POSSIBILITY OF SUCH DAMAGE.

Portions Copyright © 1993 by Digital Equipment Corporation.

Permission to use, copy, modify, and distribute this software for any purpose with or without fee is hereby granted, provided that the above copyright notice and this permission notice appear in all copies, and that the name of Digital Equipment Corporation not be used in advertising or publicity pertaining to distribution of the document or software without specific, written prior permission.

THE SOFTWARE IS PROVIDED "AS IS" AND DIGITAL EQUIPMENT CORP. DISCLAIMS ALL WARRANTIES WITH REGARD TO THIS SOFTWARE, INCLUDING ALL IMPLIED WARRANTIES OF MERCHANTABILITY AND FITNESS. IN NO EVENT SHALL DIGITAL EQUIPMENT CORPORATION BE LIABLE FOR ANY SPECIAL, DIRECT, INDIRECT, OR CONSEQUENTIAL DAMAGES OR ANY DAMAGES WHATSOEVER RESULTING FROM LOSS OF USE, DATA OR PROFITS, WHETHER IN AN ACTION OF CONTRACT, NEGLIGENCE OR OTHER TORTIOUS ACTION, ARISING OUT OF OR IN CONNECTION WITH THE USE OR PERFORMANCE OF THIS SOFTWARE.

Copyright © 1982, 1986, 1990, 1993 The Regents of the University of California. All rights reserved.

Copyright © 1983, 1993 The Regents of the University of California. All rights reserved.

Copyright © 1990, 1993 The Regents of the University of California. All rights reserved.

Redistribution and use in source and binary forms, with or without modification, are permitted provided that the following conditions are met:

1. Redistributions of source code must retain the above copyright notice, this list of conditions and the following disclaimer.
2. Redistributions in binary form must reproduce the above copyright notice, this list of conditions and the following disclaimer in the documentation and/or other materials provided with the distribution.
3. Neither the name of the University nor the names of its contributors may be used to endorse or promote products derived from this software without specific prior written permission.

THIS SOFTWARE IS PROVIDED BY THE REGENTS AND CONTRIBUTORS "AS IS" AND ANY EXPRESS OR IMPLIED WARRANTIES, INCLUDING, BUT NOT LIMITED TO, THE IMPLIED WARRANTIES OF MERCHANTABILITY AND FITNESS FOR A PARTICULAR PURPOSE ARE DISCLAIMED. IN NO EVENT SHALL THE REGENTS OR CONTRIBUTORS BE LIABLE FOR ANY DIRECT, INDIRECT, INCIDENTAL, SPECIAL, EXEMPLARY, OR CONSEQUENTIAL DAMAGES (INCLUDING, BUT NOT LIMITED TO, PROCUREMENT OF SUBSTITUTE GOODS OR SERVICES; LOSS OF USE, DATA, OR PROFITS; OR BUSINESS INTERRUPTION) HOWEVER CAUSED AND ON ANY THEORY OF LIABILITY, WHETHER IN CONTRACT, STRICT LIABILITY, OR TORT (INCLUDING NEGLIGENCE OR OTHERWISE) ARISING IN ANY WAY OUT OF THE USE OF THIS SOFTWARE, EVEN IF ADVISED OF THE POSSIBILITY OF SUCH DAMAGE. تلف

This product includes software developed by the NetBSD Foundation, Inc. and its contributors.

Copyright © 1996 The NetBSD Foundation, Inc. All rights reserved.

This code is derived from software contributed to The NetBSD Foundation by J.T. Conklin.

Copyright © 1997 The NetBSD Foundation, Inc. All rights reserved.

This code is derived from software contributed to The NetBSD Foundation by Klaus Klein.

Copyright © 1997, 1998 The NetBSD Foundation, Inc. All rights reserved.

Copyright © 1997, 98 The NetBSD Foundation, Inc. All rights reserved.

This code is derived from software contributed to The NetBSD Foundation by J.T. Conklin.

Copyright © 1997, 1998 The NetBSD Foundation, Inc. All rights reserved.

This code was contributed to The NetBSD Foundation by Klaus Klein.

Copyright © 1998 The NetBSD Foundation, Inc. All rights reserved.

This code is derived from software contributed to The NetBSD Foundation by Klaus Klein.

Copyright © 1998, 2000 The NetBSD Foundation, Inc. All rights reserved.

This code is derived from software contributed to The NetBSD Foundation by Klaus J. Klein.

Copyright © 1999, 2000 The NetBSD Foundation, Inc. All rights reserved.

This code is derived from software contributed to The NetBSD Foundation by Julian Coleman.

Copyright © 2000 The NetBSD Foundation, Inc. All rights reserved.

This code is derived from software contributed to The NetBSD Foundation by Dieter Baron and Thomas Klausner.

Copyright © 2000, 2001 The NetBSD Foundation, Inc. All rights reserved.

This code is derived from software contributed to The NetBSD Foundation by Jun-ichiro itojun Hagino and by Klaus Klein.

Copyright © 2001 The NetBSD Foundation, Inc. All rights reserved.

This code is derived from software contributed to The NetBSD Foundation by Klaus Klein.

Redistribution and use in source and binary forms, with or without modification, are permitted provided that the following conditions are met:

1. Redistributions of source code must retain the above copyright notice, this list of conditions and the following disclaimer.
2. Redistributions in binary form must reproduce the above copyright notice, this list of conditions and the following disclaimer in the documentation and/or other materials provided with the distribution.
3. All advertising materials mentioning features or use of this software must display the following acknowledgement: This product includes software developed by the NetBSD Foundation, Inc. and its contributors.
4. Neither the name of The NetBSD Foundation nor the names of its contributors may be used to endorse or promote products derived from this software without specific prior written permission.

THIS SOFTWARE IS PROVIDED BY THE NETBSD FOUNDATION, INC. AND CONTRIBUTORS "AS IS" AND ANY EXPRESS OR IMPLIED WARRANTIES, INCLUDING, BUT NOT LIMITED TO, THE IMPLIED WARRANTIES OF MERCHANTABILITY AND FITNESS FOR A PARTICULAR PURPOSE ARE DISCLAIMED. IN NO EVENT SHALL THE FOUNDATION OR CONTRIBUTORS BE LIABLE FOR ANY DIRECT, INDIRECT, INCIDENTAL, SPECIAL, EXEMPLARY, OR CONSEQUENTIAL DAMAGES (INCLUDING, BUT NOT LIMITED TO, PROCUREMENT OF SUBSTITUTE GOODS OR SERVICES; LOSS OF USE, DATA, OR PROFITS; OR BUSINESS INTERRUPTION) HOWEVER CAUSED AND ON ANY THEORY OF LIABILITY, WHETHER IN CONTRACT, STRICT LIABILITY, OR TORT (INCLUDING NEGLIGENCE OR OTHERWISE) ARISING IN ANY WAY OUT OF THE USE OF THIS SOFTWARE, EVEN IF ADVISED OF THE POSSIBILITY OF SUCH DAMAGE.

This product includes software developed by Christos Zoulas.

Copyright © 1997 Christos Zoulas. All rights reserved.

Redistribution and use in source and binary forms, with or without modification, are permitted provided that the following conditions are met:

1. Redistributions of source code must retain the above copyright notice, this list of conditions and the following disclaimer.
2. Redistributions in binary form must reproduce the above copyright notice, this list of conditions and the following disclaimer in the documentation and/or other materials provided with the distribution. تلفن شبانه روزی: ۰۲۱-۸۸۰۰۰۰۰۰
3. All advertising materials mentioning features or use of this software must display the following acknowledgement: This product includes software developed by Christos Zoulas. PharmaSOS.com
4. The name of the author may not be used to endorse or promote products derived from this software without specific prior written permission.



THIS SOFTWARE IS PROVIDED BY THE AUTHOR "AS IS" AND ANY EXPRESS OR IMPLIED WARRANTIES, INCLUDING, BUT NOT LIMITED TO, THE IMPLIED WARRANTIES OF MERCHANTABILITY AND FITNESS FOR A PARTICULAR PURPOSE ARE DISCLAIMED. IN NO EVENT SHALL THE AUTHOR BE LIABLE FOR ANY DIRECT, INDIRECT, INCIDENTAL, SPECIAL, EXEMPLARY, OR CONSEQUENTIAL DAMAGES (INCLUDING, BUT NOT LIMITED TO, PROCUREMENT OF SUBSTITUTE GOODS OR SERVICES; LOSS OF USE, DATA, OR PROFITS; OR BUSINESS INTERRUPTION) HOWEVER CAUSED AND ON ANY THEORY OF LIABILITY, WHETHER IN CONTRACT, STRICT LIABILITY, OR TORT (INCLUDING NEGLIGENCE OR OTHERWISE) ARISING IN ANY WAY OUT OF THE USE OF THIS SOFTWARE, EVEN IF ADVISED OF THE POSSIBILITY OF SUCH DAMAGE.

This product includes software developed by Winning Strategies, Inc.

Copyright © 1994 Winning Strategies, Inc. All rights reserved.

Redistribution and use in source and binary forms, with or without modification, are permitted provided that the following conditions are met:

1. Redistributions of source code must retain the above copyright notice, this list of conditions and the following disclaimer.
2. Redistributions in binary form must reproduce the above copyright notice, this list of conditions and the following disclaimer in the documentation and/or other materials provided with the distribution.
3. All advertising materials mentioning features or use of this software must display the following acknowledgement: This product includes software developed by Winning Strategies, Inc.
4. The name of the author may not be used to endorse or promote products derived from this software without specific prior written permission.

THIS SOFTWARE IS PROVIDED BY THE AUTHOR "AS IS" AND ANY EXPRESS OR IMPLIED WARRANTIES, INCLUDING, BUT NOT LIMITED TO, THE IMPLIED WARRANTIES OF MERCHANTABILITY AND FITNESS FOR A PARTICULAR PURPOSE ARE DISCLAIMED. IN NO EVENT SHALL THE AUTHOR BE LIABLE FOR ANY DIRECT, INDIRECT, INCIDENTAL, SPECIAL, EXEMPLARY, OR CONSEQUENTIAL DAMAGES (INCLUDING, BUT NOT LIMITED TO, PROCUREMENT OF SUBSTITUTE GOODS OR SERVICES; LOSS OF USE, DATA, OR PROFITS; OR BUSINESS INTERRUPTION) HOWEVER CAUSED AND ON ANY THEORY OF LIABILITY, WHETHER IN CONTRACT, STRICT LIABILITY, OR TORT (INCLUDING NEGLIGENCE OR OTHERWISE) ARISING IN ANY WAY OUT OF THE USE OF THIS SOFTWARE, EVEN IF ADVISED OF THE POSSIBILITY OF SUCH DAMAGE.

Copyright © 1995, 1996, 1997, and 1998 WIDE Project. All rights reserved.

Redistribution and use in source and binary forms, with or without modification, are permitted provided that the following conditions are met:

1. Redistributions of source code must retain the above copyright notice, this list of conditions and the following disclaimer.
2. Redistributions in binary form must reproduce the above copyright notice, this list of conditions and the following disclaimer in the documentation and/or other materials provided with the distribution.
3. Neither the name of the project nor the names of its contributors may be used to endorse or promote products derived from this software without specific prior written permission.

THIS SOFTWARE IS PROVIDED BY THE PROJECT AND CONTRIBUTORS "AS IS" AND ANY EXPRESS OR IMPLIED WARRANTIES, INCLUDING, BUT NOT LIMITED TO, THE IMPLIED WARRANTIES OF MERCHANTABILITY AND FITNESS FOR A PARTICULAR PURPOSE ARE DISCLAIMED. IN NO EVENT SHALL THE PROJECT OR CONTRIBUTORS BE LIABLE FOR ANY DIRECT, INDIRECT, INCIDENTAL, SPECIAL, EXEMPLARY, OR CONSEQUENTIAL DAMAGES (INCLUDING, BUT NOT LIMITED TO, PROCUREMENT OF SUBSTITUTE GOODS OR SERVICES; LOSS OF USE, DATA, OR PROFITS; OR BUSINESS INTERRUPTION) HOWEVER CAUSED AND ON ANY THEORY OF LIABILITY, WHETHER IN CONTRACT, STRICT LIABILITY, OR TORT (INCLUDING NEGLIGENCE OR OTHERWISE) ARISING IN ANY WAY OUT OF THE USE OF THIS SOFTWARE, EVEN IF ADVISED OF THE POSSIBILITY OF SUCH DAMAGE.

Copyright ©1999 Citrus Project, All rights reserved.

Redistribution and use in source and binary forms, with or without modification, are permitted provided that the following conditions are met:

1. Redistributions of source code must retain the above copyright notice, this list of conditions and the following disclaimer.
2. Redistributions in binary form must reproduce the above copyright notice, this list of conditions and the following disclaimer in the documentation and/or other materials provided with the distribution.

THIS SOFTWARE IS PROVIDED BY THE AUTHOR AND CONTRIBUTORS "AS IS" AND ANY EXPRESS OR IMPLIED WARRANTIES, INCLUDING, BUT NOT LIMITED TO, THE IMPLIED WARRANTIES OF MERCHANTABILITY AND FITNESS FOR A PARTICULAR PURPOSE ARE DISCLAIMED. IN NO EVENT SHALL THE AUTHOR OR CONTRIBUTORS BE LIABLE FOR ANY DIRECT, INDIRECT, INCIDENTAL, SPECIAL, EXEMPLARY, OR CONSEQUENTIAL DAMAGES (INCLUDING, BUT NOT LIMITED TO, PROCUREMENT OF SUBSTITUTE GOODS OR SERVICES; LOSS OF USE, DATA, OR PROFITS; OR BUSINESS INTERRUPTION) HOWEVER CAUSED AND ON ANY THEORY OF LIABILITY, WHETHER IN CONTRACT, STRICT LIABILITY, OR TORT (INCLUDING NEGLIGENCE OR OTHERWISE) ARISING IN ANY WAY OUT OF THE USE OF THIS SOFTWARE, EVEN IF ADVISED OF THE POSSIBILITY OF SUCH DAMAGE.

Copyright © 1995 Carnegie-Mellon University. All rights reserved. Author: Chris G. Demetriou

Copyright © 1995, 1996 Carnegie-Mellon University. All rights reserved. Author: Chris G. Demetriou

Permission to use, copy, modify and distribute this software and its documentation is hereby granted, provided that both the copyright notice and this permission notice appear in all copies of the software, derivative works or modified versions, and any portions thereof, and that both notices appear in supporting documentation.

CARNEGIE MELLON ALLOWS FREE USE OF THIS SOFTWARE IN ITS "AS IS" CONDITION. CARNEGIE MELLON DISCLAIMS ANY LIABILITY OF ANY KIND FOR ANY DAMAGES WHATSOEVER RESULTING FROM THE USE OF THIS SOFTWARE.

Carnegie Mellon requests users of this software to return to Software Distribution Coordinator or [Software.Distribution@CS.CMU.EDU](mailto:Software.Distribution@CS.CMU.EDU) School of Computer Science Carnegie Mellon University Pittsburgh PA 15213-3890 any improvements or extensions that they make and grant Carnegie the rights to redistribute these changes.

● TCP/IP, Socket Library

This product includes software developed by the University of California, Berkeley and its contributors.

Copyright © 1980, 1983, 1988, 1993 The Regents of the University of California. All rights reserved.

Copyright © 1983, 1987, 1989 The Regents of the University of California. All rights reserved.

Copyright © 1983, 1989, 1993 The Regents of the University of California. All rights reserved.

Copyright © 1985, 1988, 1993 The Regents of the University of California. All rights reserved.

Copyright © 1985, 1993 The Regents of the University of California. All rights reserved.

Copyright © 1989, 1993, 1995 The Regents of the University of California. All rights reserved.

Redistribution and use in source and binary forms, with or without modification, are permitted provided that the following conditions are met:

1. Redistributions of source code must retain the above copyright notice, this list of conditions and the following disclaimer.
2. Redistributions in binary form must reproduce the above copyright notice, this list of conditions and the following disclaimer in the documentation and/or other materials provided with the distribution.
3. All advertising materials mentioning features or use of this software must display the following acknowledgement: This product includes software developed by the University of California, Berkeley and its contributors.
4. Neither the name of the University nor the names of its contributors may be used to endorse or promote products derived from this software without specific prior written permission.

THIS SOFTWARE IS PROVIDED BY THE REGENTS AND CONTRIBUTORS "AS IS" AND ANY EXPRESS OR IMPLIED WARRANTIES, INCLUDING, BUT NOT LIMITED TO, THE IMPLIED WARRANTIES OF MERCHANTABILITY AND FITNESS FOR A PARTICULAR PURPOSE ARE DISCLAIMED. IN NO EVENT SHALL THE REGENTS OR CONTRIBUTORS BE LIABLE FOR ANY DIRECT, INDIRECT, INCIDENTAL, SPECIAL, EXEMPLARY, OR CONSEQUENTIAL DAMAGES (INCLUDING, BUT NOT LIMITED TO, PROCUREMENT OF SUBSTITUTE GOODS OR SERVICES; LOSS OF USE, DATA, OR PROFITS; OR BUSINESS INTERRUPTION) HOWEVER CAUSED AND ON ANY THEORY OF LIABILITY, WHETHER IN CONTRACT, STRICT LIABILITY, OR TORT (INCLUDING NEGLIGENCE OR OTHERWISE) ARISING IN ANY WAY OUT OF THE USE OF THIS SOFTWARE, EVEN IF ADVISED OF THE POSSIBILITY OF SUCH DAMAGE.

Copyright © 2004 by Internet Systems Consortium, Inc. ("ISC") Portions Copyright © 1996-1999 by Internet Software Consortium. Permission to use, copy, modify, and distribute this software for any purpose with or without fee is hereby granted, provided that the above copyright notice and this permission notice appear in all copies.

THE SOFTWARE IS PROVIDED "AS IS" AND ISC DISCLAIMS ALL WARRANTIES WITH REGARD TO THIS SOFTWARE INCLUDING ALL IMPLIED WARRANTIES OF MERCHANTABILITY AND FITNESS. IN NO EVENT SHALL ISC BE LIABLE FOR ANY SPECIAL, DIRECT, INDIRECT, OR CONSEQUENTIAL DAMAGES OR ANY DAMAGES WHATSOEVER RESULTING FROM LOSS OF USE, DATA OR PROFITS, WHETHER IN AN ACTION OF CONTRACT, NEGLIGENCE OR OTHER TORTIOUS ACTION, ARISING OUT OF OR IN CONNECTION WITH THE USE OR PERFORMANCE OF THIS SOFTWARE.

Portions Copyright © 1993 by Digital Equipment Corporation.

Permission to use, copy, modify, and distribute this software for any purpose with or without fee is hereby granted, provided that the above copyright notice and this permission notice appear in all copies, and that the name of Digital Equipment Corporation not be used in advertising or publicity pertaining to distribution of the document or software without specific, written prior permission.

THE SOFTWARE IS PROVIDED "AS IS" AND DIGITAL EQUIPMENT CORP. DISCLAIMS ALL WARRANTIES WITH REGARD TO THIS SOFTWARE, INCLUDING ALL IMPLIED WARRANTIES OF MERCHANTABILITY AND FITNESS. IN NO EVENT SHALL DIGITAL EQUIPMENT CORPORATION BE LIABLE FOR ANY SPECIAL, DIRECT, INDIRECT, OR CONSEQUENTIAL DAMAGES OR ANY DAMAGES WHATSOEVER RESULTING FROM LOSS OF USE, DATA OR PROFITS, WHETHER IN AN ACTION OF CONTRACT, NEGLIGENCE OR OTHER TORTIOUS ACTION, ARISING OUT OF OR IN CONNECTION WITH THE USE OR PERFORMANCE OF THIS SOFTWARE.

This product includes software developed by WIDE Project and its contributors.

Portions Copyright © 1995, 1996, 1997, and 1998 WIDE Project. All rights reserved.

Redistribution and use in source and binary forms, with or without modification, are permitted provided that the following conditions are met:

1. Redistributions of source code must retain the above copyright notice, this list of conditions and the following disclaimer.
2. Redistributions in binary form must reproduce the above copyright notice, this list of conditions and the following disclaimer in the documentation and/or other materials provided with the distribution.
3. All advertising materials mentioning features or use of this software must display the following acknowledgement: This product includes software developed by WIDE Project and its contributors.
4. Neither the name of the project nor the names of its contributors may be used to endorse or promote products derived from this software without specific prior written permission.

THIS SOFTWARE IS PROVIDED BY THE PROJECT AND CONTRIBUTORS "AS IS" AND ANY EXPRESS OR IMPLIED WARRANTIES, INCLUDING, BUT NOT LIMITED TO, THE IMPLIED WARRANTIES OF MERCHANTABILITY AND FITNESS FOR A PARTICULAR PURPOSE ARE DISCLAIMED. IN NO EVENT SHALL THE PROJECT OR CONTRIBUTORS BE LIABLE FOR ANY DIRECT, INDIRECT, INCIDENTAL, SPECIAL, EXEMPLARY, OR CONSEQUENTIAL DAMAGES (INCLUDING, BUT NOT LIMITED TO, PROCUREMENT OF SUBSTITUTE GOODS OR SERVICES; LOSS OF USE, DATA, OR PROFITS; OR BUSINESS INTERRUPTION) HOWEVER CAUSED AND ON ANY THEORY OF LIABILITY, WHETHER IN CONTRACT, STRICT LIABILITY, OR TORT (INCLUDING NEGLIGENCE OR OTHERWISE) ARISING IN ANY WAY OUT OF THE USE OF THIS SOFTWARE, EVEN IF ADVISED OF THE POSSIBILITY OF SUCH DAMAGE.

Copyright © 1988 Stephen Deering.

Copyright © 1982, 1986 Regents of the University of California. All rights reserved.

Redistribution and use in source and binary forms, with or without modification, are permitted provided that the following conditions are met:

1. Redistributions of source code must retain the above copyright notice, this list of conditions and the following disclaimer.
2. Redistributions in binary form must reproduce the above copyright notice, this list of conditions and the following disclaimer in the documentation and/or other materials provided with the distribution.
3. [rescinded 22 July 1999]
4. Neither the name of the University nor the names of its contributors may be used to endorse or promote products derived from this software without specific prior written permission.

THIS SOFTWARE IS PROVIDED BY THE REGENTS AND CONTRIBUTORS "AS IS" AND ANY EXPRESS OR IMPLIED WARRANTIES, INCLUDING, BUT NOT LIMITED TO, THE IMPLIED WARRANTIES OF MERCHANTABILITY AND FITNESS FOR A PARTICULAR PURPOSE ARE DISCLAIMED. IN NO EVENT SHALL THE REGENTS OR CONTRIBUTORS BE LIABLE FOR ANY DIRECT, INDIRECT, INCIDENTAL, SPECIAL, EXEMPLARY, OR CONSEQUENTIAL DAMAGES (INCLUDING, BUT NOT LIMITED TO, PROCUREMENT OF SUBSTITUTE GOODS OR SERVICES; LOSS OF USE, DATA, OR PROFITS; OR BUSINESS INTERRUPTION) HOWEVER CAUSED AND ON ANY THEORY OF LIABILITY, WHETHER IN CONTRACT, STRICT LIABILITY, OR TORT (INCLUDING NEGLIGENCE OR OTHERWISE) ARISING IN ANY WAY OUT OF THE USE OF THIS SOFTWARE, EVEN IF ADVISED OF THE POSSIBILITY OF SUCH DAMAGE.

Copyright © 1982, 1986, 1988 Regents of the University of California. All rights reserved.

Redistribution and use in source and binary forms are permitted provided that the above copyright notice and this paragraph are duplicated in all such forms and that any documentation and other materials related to such distribution and use acknowledge that the software was developed by the University of California, Berkeley. The name of the University may not be used to endorse or promote products derived from this software without specific prior written permission.

THIS SOFTWARE IS PROVIDED "AS IS" AND WITHOUT ANY EXPRESS OR IMPLIED WARRANTIES, INCLUDING, WITHOUT LIMITATION, THE IMPLIED WARRANTIES OF MERCHANTABILITY AND FITNESS FOR A PARTICULAR PURPOSE.

Rights, responsibilities and use of this software are controlled by the agreement found in the "LICENSE.H" file distributed with this source code. "LICENSE.H" may not be removed from this distribution, modified, enhanced nor references to it omitted.

Copyright 1983 by the Massachusetts Institute of Technology

Copyright 1984 by the Massachusetts Institute of Technology

Copyright 1984, 1985 by the Massachusetts Institute of Technology

Copyright 1990 by NetPort Software

Copyright 1990-1993 by NetPort Software.

Copyright 1990-1994 by NetPort Software.

Copyright 1990-1996 by NetPort Software.

Copyright 1990-1997 by NetPort Software.

Copyright 1993 by NetPort Software

Copyright 1986 by Carnegie Mellon

All Rights Reserved

Permission to use, copy, modify, and distribute this software and its documentation for any purpose and without fee is hereby granted, provided that the above copyright notice appear in all copies and that both that copyright notice and this permission notice appear in supporting documentation, and that the name of CMU not be used in advertising or publicity pertaining to distribution of the software without specific, written prior permission.



### ● OpenSSL

This product includes software developed by the OpenSSL Project for use in the OpenSSL Toolkit. (<http://www.openssl.org/>) This product includes cryptographic software written by Eric Young ([eay@cryptsoft.com](mailto:eay@cryptsoft.com)). This product includes software written by Tim Hudson ([tjh@cryptsoft.com](mailto:tjh@cryptsoft.com)).

#### OpenSSL License

Copyright © 1998-2008 The OpenSSL Project. All rights reserved.

Redistribution and use in source and binary forms, with or without modification, are permitted provided that the following conditions are met:

1. Redistributions of source code must retain the above copyright notice, this list of conditions and the following disclaimer.
2. Redistributions in binary form must reproduce the above copyright notice, this list of conditions and the following disclaimer in the documentation and/or other materials provided with the distribution.
3. All advertising materials mentioning features or use of this software must display the following acknowledgment: "This product includes software developed by the OpenSSL Project for use in the OpenSSL Toolkit. (<http://www.openssl.org/>)"
4. The names "OpenSSL Toolkit" and "OpenSSL Project" must not be used to endorse or promote products derived from this software without prior written permission. For written permission, please contact [openssl-core@openssl.org](mailto:openssl-core@openssl.org).
5. Products derived from this software may not be called "OpenSSL" nor may "OpenSSL" appear in their names without prior written permission of the OpenSSL Project.
6. Redistributions of any form whatsoever must retain the following acknowledgment: "This product includes software developed by the OpenSSL Project for use in the OpenSSL Toolkit (<http://www.openssl.org/>)"

THIS SOFTWARE IS PROVIDED BY THE OpenSSL PROJECT "AS IS" AND ANY EXPRESSED OR IMPLIED WARRANTIES, INCLUDING, BUT NOT LIMITED TO, THE IMPLIED WARRANTIES OF MERCHANTABILITY AND FITNESS FOR A PARTICULAR PURPOSE ARE DISCLAIMED. IN NO EVENT SHALL THE OpenSSL PROJECT OR ITS CONTRIBUTORS BE LIABLE FOR ANY DIRECT, INDIRECT, INCIDENTAL, SPECIAL, EXEMPLARY, OR CONSEQUENTIAL DAMAGES (INCLUDING, BUT NOT LIMITED TO, PROCUREMENT OF SUBSTITUTE GOODS OR SERVICES; LOSS OF USE, DATA, OR PROFITS; OR BUSINESS INTERRUPTION) HOWEVER CAUSED AND ON ANY THEORY OF LIABILITY, WHETHER IN CONTRACT, STRICT LIABILITY, OR TORT (INCLUDING NEGLIGENCE OR OTHERWISE) ARISING IN ANY WAY OUT OF THE USE OF THIS SOFTWARE, EVEN IF ADVISED OF THE POSSIBILITY OF SUCH DAMAGE.

This product includes cryptographic software written by Eric Young ([eay@cryptsoft.com](mailto:eay@cryptsoft.com)). This product includes software written by Tim Hudson ([tjh@cryptsoft.com](mailto:tjh@cryptsoft.com)).

Original SSLeay License

Copyright © 1995-1998 Eric Young ([eay@cryptsoft.com](mailto:eay@cryptsoft.com)) All rights reserved.

This package is an SSL implementation written by Eric Young ([eay@cryptsoft.com](mailto:eay@cryptsoft.com)). The implementation was written so as to conform with Netscapes SSL. This library is free for commercial and non-commercial use as long as the following conditions are aheared to. The following conditions apply to all code found in this distribution, be it the RC4, RSA, lhash, DES, etc., code; not just the SSL code. The SSL documentation included with this distribution is covered by the same copyright terms except that the holder is Tim Hudson ([tjh@cryptsoft.com](mailto:tjh@cryptsoft.com)). Copyright remains Eric Young's, and as such any Copyright notices in the code are not to be removed. If this package is used in a product, Eric Young should be given attribution as the author of the parts of the library used. This can be in the form of a textual message at program startup or in documentation (online or textual) provided with the package.

Redistribution and use in source and binary forms, with or without modification, are permitted provided that the following conditions are met:

1. Redistributions of source code must retain the copyright notice, this list of conditions and the following disclaimer.
2. Redistributions in binary form must reproduce the above copyright notice, this list of conditions and the following disclaimer in the documentation and/or other materials provided with the distribution.
3. All advertising materials mentioning features or use of this software must display the following acknowledgement: "This product includes cryptographic software written by Eric Young ([eay@cryptsoft.com](mailto:eay@cryptsoft.com))" The word 'cryptographic' can be left out if the routines from the library being used are not cryptographic related :-).
4. If you include any Windows specific code (or a derivative thereof) from the apps directory (application code) you must include an acknowledgement: "This product includes software written by Tim Hudson ([tjh@cryptsoft.com](mailto:tjh@cryptsoft.com))"

THIS SOFTWARE IS PROVIDED BY ERIC YOUNG "AS IS" AND ANY EXPRESS OR IMPLIED WARRANTIES, INCLUDING, BUT NOT LIMITED TO, THE IMPLIED WARRANTIES OF MERCHANTABILITY AND FITNESS FOR A PARTICULAR PURPOSE ARE DISCLAIMED. IN NO EVENT SHALL THE AUTHOR OR CONTRIBUTORS BE LIABLE FOR ANY DIRECT, INDIRECT, INCIDENTAL, SPECIAL, EXEMPLARY, OR CONSEQUENTIAL DAMAGES (INCLUDING, BUT NOT LIMITED TO, PROCUREMENT OF SUBSTITUTE GOODS OR SERVICES; LOSS OF USE, DATA, OR PROFITS; OR BUSINESS INTERRUPTION) HOWEVER CAUSED AND ON ANY THEORY OF LIABILITY, WHETHER IN CONTRACT, STRICT LIABILITY, OR TORT (INCLUDING NEGLIGENCE OR OTHERWISE) ARISING IN ANY WAY OUT OF THE USE OF THIS SOFTWARE, EVEN IF ADVISED OF THE POSSIBILITY OF SUCH DAMAGE.

The licence and distribution terms for any publically available version or derivative of this code cannot be changed. i.e. this code cannot simply be copied and put under another distribution licence [including the GNU Public Licence.

## Using the radio

Press the “RADIO” button to display the radio control screen.

Select the “AM”, “FM”, “SAT” or “Apps” tab or press the “RADIO” button repeatedly to select the desired tab.

امداد خودرو فارما

تلفن شبانه روزی: ۰۲۱-۸۸۸۶۲۰۸۵

[FarmaSOS.com](http://FarmaSOS.com)

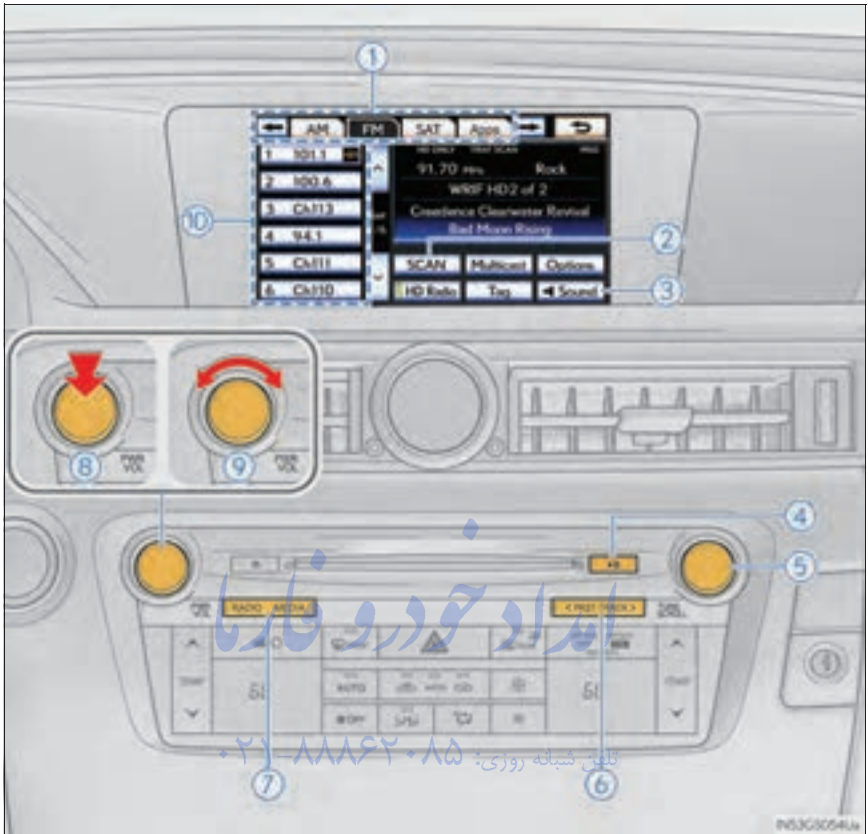

- ① AM/FM/SAT/Apps mode tabs      ⑦ AM/FM/SAT/Apps mode button
- ② Scanning for receivable stations
- ③ Setting the sound (→P. 474)      ⑧ Power
- ④ Mute      ⑨ Volume
- ⑤ Adjusting the frequency      ⑩ Preset stations
- ⑥ Preset turning/seeking the frequency

## Selecting a station (excluding XM® Satellite Radio)

### ■ Seek tuning

Press and hold “<” or “>” on the “PRST•TRACK” button.

### ■ Manual tuning

Turn the “TUNE/SCROLL” knob.

### ■ Preset stations

Select the desired preset stations (1 - 6).

Change the page by using “^” or “v” on the screen.

## Setting station presets (excluding XM® Satellite Radio)

- 1 Search for desired stations.
- 2 Select one of the left side screen buttons (1-6) and hold it until a beep is heard. There are 6 sets of 6 presets. There is a total of 36 presets.



## Scanning radio stations (excluding XM® Satellite Radio)

Scanning all radio stations within range

- 1 Select “SCAN” on the screen.

“SCAN” appears on the screen.

The radio will find the next station and stay there for 10 seconds if “All” or “HD Only” is selected, or 5 seconds if “Analog” is selected, and then scan again.

(→P. 394)

- 2 Select “SCAN” once again when the desired station is reached.

## RBDS (Radio Broadcast Data Systems)

This feature allows your radio to receive station identification information and program information (classical, jazz, etc.) from radio stations which broadcast this information.

### ■ Receiving RBDS broadcasts

- 1 Select “Options” on the screen.

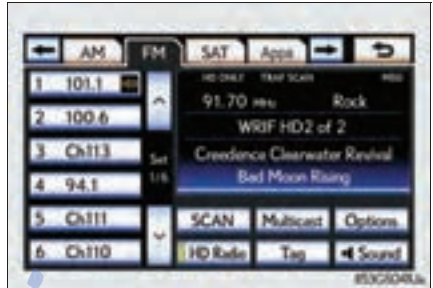

- 2 Select “< TYPE” or “TYPE >” on the screen.



The program list changes as follows each time the switch is selected.

- Classical
- Country
- EasyLis (Easy Listening)
- Inform (Information)
- Jazz
- News
- Oldies
- Other
- Pop Music
- Religion
- Rock
- R&B (Rhythm and Blues)
- Sports
- Talk
- Traffic (Not available when “HD Radio Settings” are set to analog.)
- Alert (Emergency Alert)

When a program is set, "TYPE SEEK" appears.

- 3 Select "TYPE SEEK" on the screen.

The radio seeks for stations by the relevant program type.

If no relevant program can be found, "no type" appears on the screen.

### ■ Traffic announcement

Select "Traffic" on the screen.

"TRAF SEEK" appears on the display, and the radio seeks a traffic program station.

If no traffic program station is found, "No Traffic" appears on the display.

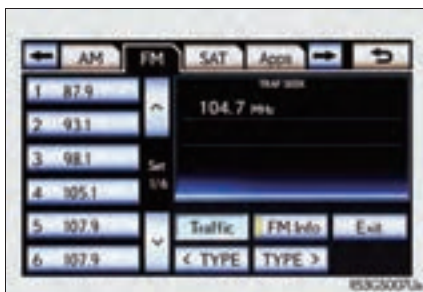

### HD Radio™ system settings

HD Radio™ system can be set using the procedure outlined below.

- 1 Press the "MENU" button on the Remote Touch, then select "Setup".
- 2 Select "Audio".

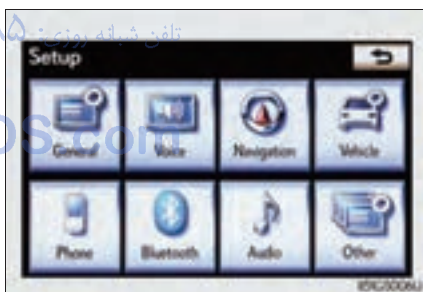

- 3 Select "HD Radio Settings".

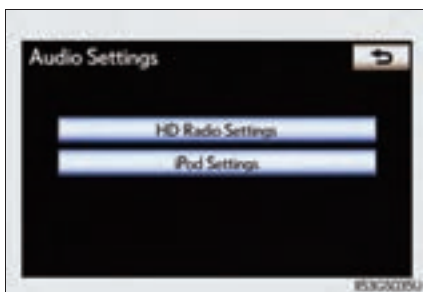



- 4 Select “HD Radio/Analog Setting”.



- 5 Select the item to be set.

“All”: Select to receive both analog and digital broadcasts.

“HD Only”: Select to receive only digital broadcasts.

“Analog”: Select to receive only analog broadcasts.

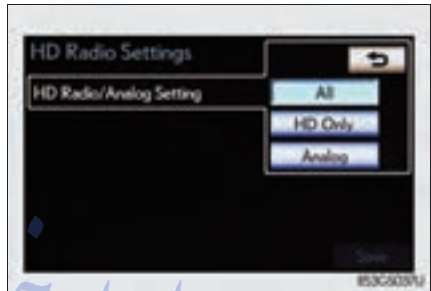

- 6 Select “Save”.

## HD Radio™ Technology

HD Radio™ Technology is the digital evolution of analog AM/FM radio. Your radio product has a special receiver which allows it to receive digital broadcasts (where available) in addition to the analog broadcasts it already receives.

Digital broadcasts have better sound quality than analog broadcasts as digital broadcasts provide free, crystal clear audio with no static or distortion. For more information, and a guide to available radio stations and programming, refer to [www.hdradio.com](http://www.hdradio.com).

### ■ Using HD Radio™ Technology

- 1 Press the “RADIO” button.
- 2 Select the “AM” or “FM” tab or press the “RADIO” button repeatedly to select the desired tab.

An orange “HD” logo indicator will be displayed on the screen when in digital.

The song title, artist name and music genre will appear on the screen when available by the radio station.

- 3 Select “Options” to display this screen.

When “Text” is selected, information such as the artist name, song title, album title and music genre of the track being listened to are displayed on the text screen. To display messages from the station, select “Additional Information”.

When “< TYPE” or “TYPE >” is selected, a program type will be searched. Once a program type has been set, “TYPE SEEK” will appear on the screen. (→P.393)

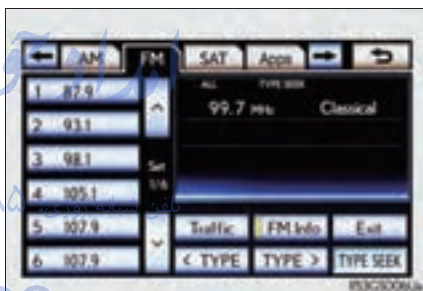

## Available HD Radio™ Technology

On the FM radio frequency most digital stations have “multiple” or supplemental programs on one FM station.

### ■ Multicast

Select “Multicast”.

Each time “Multicast” is selected, the supplemental program changes.

If “Multicast” is selected when tuned to the last of the supplemental programs, the main program will be returned to.

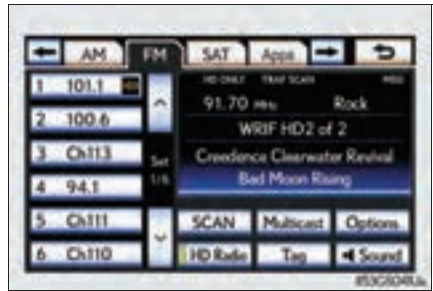

### ■ Tag

- 1 Select “Tag” to bookmark the music information.

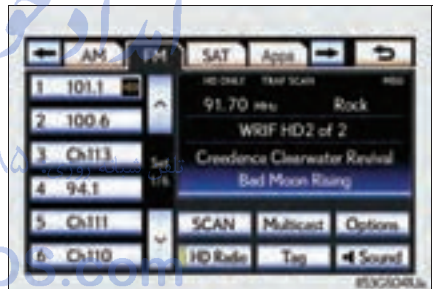

- 2 Open the console box, open the cover and connect an iPod using an iPod cable. (→P. 466)

Turn on the power of the iPod if it is not turned on.

Once an iPod is connected, the music tag moves from the radio into the iPod.

When the iPod is connected to iTunes, the “tagged” information of the songs which were tagged while listening to the radio can be viewed. Then a user may decide to purchase the song or CD/Album which had been listened to on their radio.

If tagging the music information fails, “Saving the HD Radio tag failed.” will be displayed on the screen. If this occurs, tag the information again.

## XM® Satellite Radio

### ■ Receiving XM® Satellite Radio

- 1 Press the “RADIO” button.
- 2 Select the “SAT” tab or press the “RADIO” button repeatedly until the “SAT” tab is selected to choose a satellite broadcast channel.



- 3 Turn the “TUNE/SCROLL” knob to select the next or previous channel.

Turning the knob quickly allows rapid scrolling through the channel list.

### ■ Presetting XM® Satellite Radio channels

- 1 Select the desired channel.
- 2 Select one of the left side screen buttons (1-6) and hold it until a beep is heard.

To change the preset channel to a different one, follow the same procedure.



### ■ Changing the channel category

Select either “< TYPE” or “TYPE >” to go to the next or previous category.



### ■ Seeking the channel within the current category

Press and hold “<” or “>” on the “PRST•TRACK” button.

### ■ Scanning XM<sup>®</sup> Satellite Radio channels

Scanning channels in the current category

- 1 Select “SCAN” on the screen.

“SCAN” appears on the screen.

- 2 Select “SCAN” once again when the desired channel is reached.

### ■ Displaying the title and artist name

Select “Text” to display the song title and artist name currently being listening to.

Up to 64 alphanumeric characters can be displayed. (Some information will not be fully displayed.)



تلفن شبانه روزی: ۰۲۱-۸۸۶۲۰۸۵

FarmaSOS.com

### Internet radio broadcast (vehicles with the navigation system)

One of Apps' features is the ability to listen to internet radio. In order to use this service, an Apps compatible phone and the navigation system need to be set. For details, refer to the "Navigation System Owner's Manual".

- 1 Press the "RADIO" button.
- 2 Select the "Apps" tab or press the "RADIO" button repeatedly until the "Apps" tab is selected.

If a compatible phone is already registered, it will be connected automatically.

If a compatible phone has not been registered or the Bluetooth® connection cannot be completed correctly, select "Connect" to register and/or connect your phone. (→P. 494)

When connection is complete, the application screen can be displayed.

- 3 Select "View Application Screen" on the screen.

The internet radio application screen is displayed.

Perform operations according to the displayed application screen.

By pressing the "RADIO" button, the "Audio" screen can be returned to.



### Silencing the sound

Press .

Press the button again to turn the system back on.

### ■ If you select

The display returns to the previous screen.

### ■ When the battery is disconnected

All preset stations are erased.

### ■ Reception sensitivity

- Cargo loaded on the roof luggage carrier, especially metal objects, may adversely affect the reception of XM<sup>®</sup> Satellite Radio.
- Maintaining perfect radio reception at all times is difficult due to the continually changing position of the antenna, differences in signal strength and surrounding objects, such as trains, transmitters, etc.
- The radio antenna is mounted inside the rear quarter window. To maintain clear radio reception, do not attach metallic window tinting or other metallic objects to the antenna wire mounted inside the rear quarter window.

### ■ HD Radio™ Technology troubleshooting guide

Experience	Cause	Action
Mismatch of time alignment- a user may hear a short period of programming replayed or an echo, stutter or skip.	The radio stations analog and digital volume are not properly aligned or the station is in ballgame mode.	None, radio broadcast issue. A user can contact the radio station.
Sound fades, blending in and out.	Radio is shifting between analog and digital audio.	Reception issue, may clear-up as the vehicle continues to be driven. Selecting "Analog" can force radio in an analog audio.
Audio mute condition when an HD2/HD3 multicast channel had been playing.	The radio does not have access to digital signals at the moment.	This is normal behavior, wait until the digital signal returns. If out of the coverage area, seek a new station.
Audio mute delay when selecting an HD2/HD3 multicast channel preset.	The digital multicast content is not available until HD Radio™ broadcast can be decoded and make the audio available. This takes up to 7 seconds.	This is normal behavior, wait for the audio to become available.

Experience	Cause	Action
Text information does not match the present song audio.	Data service issue at the radio broadcaster.	Broadcaster should be notified. Complete the form: <a href="http://www.ibility.com/automotive/report_radio_station_experiences">www.ibility.com/automotive/report_radio_station_experiences</a> .
No text information shown for the present selected frequency.	Data service issue by the radio broadcaster.	Broadcaster should be notified. Complete the form: <a href="http://www.ibility.com/automotive/report_radio_station_experiences">www.ibility.com/automotive/report_radio_station_experiences</a> .

امداد خودرو فارما

تلفن شبانه روزی: ۰۲۱-۸۸۶۲۰۸۵

FarmaSOS.com



## ■ XM Radio Services – Descriptions (vehicles without a navigation system for U.S.A.)

### ● Radio and Entertainment

XM offers more than 170 satellite radio channels of commercial-free music and premier sports, news, talk, and entertainment. XM is broadcast via satellites to millions of listeners across the continental United States. XM subscribers listen to XM on satellite radio receivers for the car, home, and portable use. More information about XM is available online at [www.siriusxm.com](http://www.siriusxm.com).

### ● Satellite tuner

The tuner supports only Audio Services (Music and Talk) and the accompanying Text Information of XM<sup>®</sup> Satellite Radio.

## ■ XM Radio Services – Subscription Instructions (vehicles without a navigation system for U.S.A.)

For XM Services requiring a subscription (such as XM Radio), the following paragraph shall be included.

Required XM Radio monthly subscriptions sold separately after trial period. Subscription fee is consumer only. All fees and programming subject to change. Subscriptions are subject to the Customer Agreement available at [www.siriusxm.com](http://www.siriusxm.com). XM service only available in the 48 contiguous United States. © 2011 Sirius XM Radio Inc. Sirius, XM and all related marks and logos are trademarks of Sirius XM Radio Inc. All other marks, channel names and logos are the property of their respective owners. تلفن شبانه روزی: ۰۲۱-۸۸۶۲۰۸۵

For more information, program schedules, and to subscribe or extend subscription after complimentary trial period; more information is available at:

U.S.A. Customers:

Visit [www.siriusxm.com](http://www.siriusxm.com) or call 1-877-515-3987

### ● Radio ID

You will need the radio ID when activating XM<sup>®</sup> service or reporting a problem. If "CH 000" is selected using the "TUNE/SCROLL" knob, the ID code, which is 8 alphanumeric characters, will be displayed. If another channel is selected, the ID code will no longer be displayed. The channel (000) alternates between displaying the radio ID and the specific radio code.

■ **XM Radio Services – Legal Disclaimers and Warnings (vehicles without a navigation system for U.S.A.)**

- Fees and Taxes – Subscription fee, taxes, one time activation fee, and other fees may apply. Subscription fee is consumer only. All fees and programming subject to change. Subscriptions subject to Customer Agreement available at [www.siriusxm.com](http://www.siriusxm.com). XM service only available in the 48 contiguous United States and Canada.

Explicit Language Notice – Channels with frequent explicit language are indicated with an “XL” preceding the channel name. Channel blocking is available for XM Satellite Radio receivers by notifying XM at;

U.S.A. Customers:

Visit [www.siriusxm.com](http://www.siriusxm.com) or calling 1-877-515-3987

It is prohibited to copy, decompile, disassemble, reverse engineer, hack, manipulate, or otherwise make available any technology or software incorporated in receivers compatible with the XM Satellite Radio System or that support the XM website, the Online Service or any of its content. Furthermore, the AMBE<sup>®</sup> voice compression software included in this product is protected by intellectual property rights including patent rights, copyrights, and trade secrets of Digital Voice Systems, Inc.

Note: this applies to XM receivers only and not XM Ready devices.

تلفن شبانه روزی: ۰۲۱-۸۸۶۲۰۸۵

FarmaSOS.com

### ■ XM Radio Services – Descriptions (vehicles without a navigation system for Canada)

#### ● Radio and Entertainment

XM offers more than 170 satellite radio channels of commercial-free music and premier sports, news, talk, and entertainment. XM is broadcast via satellites to millions of listeners across the continental United States. XM subscribers listen to XM on satellite radio receivers for the car, home, and portable use. More information about XM is available online at [www.xmradio.ca](http://www.xmradio.ca).

#### ● Satellite tuner

The tuner supports only Audio Services (Music and Talk) and the accompanying Text Information of XM<sup>®</sup> Satellite Radio.

### ■ XM Radio Services – Subscription Instructions (vehicles without a navigation system for Canada)

For XM Services requiring a subscription (such as XM Radio), the following paragraph shall be included.

Required XM Radio monthly subscriptions sold separately after trial period. Subscription fee is consumer only. All fees and programming subject to change. Subscriptions are subject to the Customer Agreement available at [www.xmradio.ca](http://www.xmradio.ca). XM service only available in 10 Canadian provinces. © 2011 Sirius XM Radio Inc. Sirius, XM and all related marks and logos are trademarks of Sirius XM Radio Inc. All other marks, channel names and logos are the property of their respective owners.

For more information, program schedules, and to subscribe or extend subscription after complimentary trial period; more information is available at:

Canadian Customers:

Visit [www.xmradio.ca](http://www.xmradio.ca) or call 1-877-515-3987

#### ● Radio ID

You will need the radio ID when activating XM<sup>®</sup> service or reporting a problem. If “CH 000” is selected using the “TUNE/SCROLL” knob, the ID code, which is 8 alphanumeric characters, will be displayed. If another channel is selected, the ID code will no longer be displayed. The channel (000) alternates between displaying the radio ID and the specific radio code.

### ■ XM Radio Services – Legal Disclaimers and Warnings (vehicles without a navigation system for Canada)

Fees and Taxes – Subscription fee, taxes, one time activation fee, and other fees may apply. Subscription fee is consumer only. All fees and programming subject to change. Subscriptions subject to Customer Agreement available at [www.xmradio.ca](http://www.xmradio.ca). XM service only available in the 48 contiguous United States and Canada\*.

\*Canada – some deterioration of service may occur in extreme northern latitudes. This is beyond the control of XM Satellite Radio.

Explicit Language Notice – Channels with frequent explicit language are indicated with an “XL” preceding the channel name. Channel blocking is available for XM Satellite Radio receivers by notifying XM at;

Canadian Customers – Visit [www.xmradio.ca](http://www.xmradio.ca) or calling 1-877-515-3987

It is prohibited to copy, decompile, disassemble, reverse engineer, hack, manipulate, or otherwise make available any technology or software incorporated in receivers compatible with the XM Satellite Radio System or that support the XM website, the Online Service or any of its content. Furthermore, the AMBE<sup>®</sup> voice compression software included in this product is protected by intellectual property rights including patent rights, copyrights, and trade secrets of Digital Voice Systems, Inc.

Note: this applies to XM receivers only and not XM Ready devices.

تلفن شبانه روزی: ۰۲۱-۸۸۶۲۰۸۵

FarmaSOS.com

### ■ XM Radio Services – Descriptions (vehicles with a navigation system)

#### ● Radio and Entertainment

XM offers more than 170 satellite radio channels of commercial-free music and premier sports, news, talk, and entertainment. XM is broadcast via satellites to millions of listeners across the continental United States. XM subscribers listen to XM on satellite radio receivers for the car, home, and portable use. More information about XM is available online at [www.siriusxm.com](http://www.siriusxm.com). (U.S.A.) or [www.xmradio.ca](http://www.xmradio.ca) (Canada)

#### ● Infotainment and Data services

XM offers a variety of advanced Infotainment and data services.

### ■ XM Radio Services – Subscription Instructions (vehicles with a navigation system)

For XM Services requiring a subscription (such as XM Radio, and some Infotainment & data services), the following paragraph shall be included.

Required XM Radio and some Infotainment & data services monthly subscriptions sold separately after trial period. Subscription fee is consumer only. All fees and programming subject to change. Subscriptions are subject to the Customer Agreement available at [www.siriusxm.com](http://www.siriusxm.com). (U.S.A.) or [www.xmradio.ca](http://www.xmradio.ca) (Canada) XM service only available in the 48 contiguous United States and 10 Canadian provinces. © 2011 Sirius XM Radio Inc. Sirius, XM and all related marks and logos are trademarks of Sirius XM Radio Inc. All other marks, channel names and logos are the property of their respective owners.

For more information, program schedules, and to subscribe or extend subscription after complimentary trial period; more information is available at:

#### ▶ U.S.A. Customers:

Visit [www.siriusxm.com](http://www.siriusxm.com) or call 1-877-515-3987

#### ▶ Canadian Customers:

Visit [www.xmradio.ca](http://www.xmradio.ca) or call 1-877-515-3987

#### ● Radio ID

You will need the radio ID when activating XM<sup>®</sup> service or reporting a problem. If “CH 000” is selected using the “TUNE/SCROLL” knob, the ID code, which is 8 alphanumeric characters, will be displayed. If another channel is selected, the ID code will no longer be displayed. The channel (000) alternates between displaying the radio ID and the specific radio code.

### ■ XM Radio Services – Legal Disclaimers and Warnings (vehicles with a navigation system)

Fees and Taxes – Subscription fee, taxes, one time activation fee, and other fees may apply. Subscription fee is consumer only. All fees and programming subject to change. Subscriptions subject to Customer Agreement available at [www.siriusxm.com](http://www.siriusxm.com). (U.S.A.) or [www.xmradio.ca](http://www.xmradio.ca) (Canada) XM service only available in the 48 contiguous United States and Canada\*.

\*Canada – some deterioration of service may occur in extreme northern latitudes. This is beyond the control of XM Satellite Radio.

Explicit Language Notice – Channels with frequent explicit language are indicated with an “XL” preceding the channel name. Channel blocking is available for XM Satellite Radio receivers by notifying XM at;

▶ U.S.A. Customers:

Visit [www.siriusxm.com](http://www.siriusxm.com) or calling 1-877-515-3987

▶ Canadian Customers:

Visit [www.xmradio.ca](http://www.xmradio.ca) or calling 1-877-515-3987

It is prohibited to copy, decompile, disassemble, reverse engineer, hack, manipulate, or otherwise make available any technology or software incorporated in receivers compatible with the XM Satellite Radio System or that support the XM website, the Online Service or any of its content. Furthermore, the AMBE<sup>®</sup> voice compression software included in this product is protected by intellectual property rights including patent rights, copyrights, and trade secrets of Digital Voice Systems, Inc.

Note: this applies to XM receivers only and not XM Ready devices.

### ■ If the satellite radio does not operate normally

If a problem occurs with the XM<sup>®</sup> tuner, a message will appear on the screen. Refer to the table below to identify the problem, and take the suggested corrective action.

Ck Antenna	The XM <sup>®</sup> antenna is not connected. Check whether the XM <sup>®</sup> antenna cable is attached securely.
	There is a short-circuit in the antenna or the surrounding antenna cable. See a Lexus certified dealer.
Ch Unauth	You have not subscribed to XM <sup>®</sup> Satellite Radio. The radio is being updated with the latest encryption code. Contact XM <sup>®</sup> Satellite Radio for subscription information. When a contract is canceled, you can choose "CH 000" and all free-to-air channels.
	The premium channel you selected is not authorized. Wait for about 2 seconds until the radio returns to the previous channel or "CH 001". If it does not change automatically, select another channel. To listen to the premium channel, contact XM <sup>®</sup> Satellite Radio.
No Signal	The XM <sup>®</sup> signal is too weak at the current location. Wait until your vehicle reaches a location with a stronger signal.
Loading	The unit is acquiring audio or program information. Wait until the unit has received the information.
Ch Off Air	The channel you selected is not broadcasting any programming. Select another channel.
-----	There is no song/program title or artist name/feature associated with the channel at that time. No action is required.
Ch Unavail	The channel you selected is no longer available. Wait for about 2 seconds until the radio returns to the previous channel or "CH 001". If it does not change automatically, select another channel.

Contact the XM<sup>®</sup> Listener Care Center at 1-877-515-3987.

**■ About internet radio (vehicles with the navigation system)**

- Other applications can be activated while listening to internet radio.
- An iPhone cannot be connected via Bluetooth® and USB connection at the same time. However, it is possible to recharge an iPhone while using Apps by connecting via USB. The system uses the connection method that was used last. Therefore, if connected via USB after Bluetooth® connection, it is necessary to reconnect the iPhone via Bluetooth®.
- Services requiring a separate contract can also be used. For details, refer to <http://www.lexus.com/enform/> or call 1-800-255-3987.
- If internet radio has never been listened to by activating “Apps” from the “Information” screen, the “Apps” tab will be dimmed.

**■ Trademark owned**

HD Radio Technology manufactured under license from iBiquity Digital Corporation. U.S. and Foreign Patents. HD Radio™ and the HD, HD Radio, and “Arc” logos are proprietary trademarks of iBiquity Digital Corp.

تلفن شبانه روزی: ۰۲۱-۸۸۶۲۰۸۵

FarmaSOS.com



### ■ Certifications for the radio tuner

This equipment has been tested and found to comply with the limits for a class B digital device, pursuant to Part 15 of the FCC Rules. These limits are designed to provide reasonable protection against harmful interference in a residential installation. This equipment generates, uses and can radiate radio frequency energy and, if not installed and used in accordance with the instructions, may cause harmful interference to radio communications. However, there is no guarantee that interference will not occur in a particular installation.

If this equipment does cause harmful interference to radio or television reception, which can be determined by turning the equipment off and on, the user is encouraged to try to correct the interference by one or more of the following measures:

- Reorienting or relocate the receiving antenna.
- Increasing the separation between the equipment and receiver.
- Consult the equipment into an outlet on a circuit different from that to which the receiver is connected.
- Consulting the dealer or an experienced radio/TV technician for help.

### ■ Certifications for XM<sup>®</sup> Satellite Radio

This device complies with RSS-310 of Industry Canada. Operation is subject to the condition that this device does not cause harmful interference.

This device complies with Industry Canada licence-exempt RSS standard(s). Operation is subject to the following two conditions: (1) this device may not cause interference, and (2) this device must accept any interference, including interference that may cause undesired operation of the device.

Cet appareil est conforme au CNR-310 d'Industrie Canada. Son exploitation est autorisée sous réserve que l'appareil ne cause pas de brouillage préjudiciable.

Le présent appareil est conforme aux CNR d'Industrie Canada applicables aux appareils radio exempts de licence. L'exploitation est autorisée aux deux conditions suivantes : (1) l'appareil ne doit pas produire de brouillage, et (2) l'utilisateur de l'appareil doit accepter tout brouillage radioélectrique subi, même si le brouillage est susceptible d'en compromettre le fonctionnement.

## Using the CD/DVD player



- |   |                |
|---|----------------|
| ① Setting the sound (→P. 474)                           | ⑥ MEDIA button |
| ② Disc slot   | ⑦ Disc eject   |
| ③ Play/pause  | ⑧ Power        |
| ④ Track/file selection                                  | ⑨ Volume       |
| ⑤ Track, file and chapter selection/fast forward/rewind |                |

### Inserting a disc

Insert a disc into the disc slot.

### Ejecting a disc

Press  and remove the disc.

### Playing and pausing a track/file/chapter

To play or pause a track/file/chapter, press .

#### ■ Using the display

- Under extremely cold conditions, the screen may react slowly or operation sound may become louder.
- If a disc is inserted with the label facing down, it cannot be played.

امداد خودرو فارما

تلفن شبانه روزی: ۰۲۱-۸۸۶۲۰۸۵

FarmaSOS.com

## Playing an audio CD and MP3/WMA discs

Press the “MEDIA” button if a disc has already been loaded in the disc slot.

Select the “DISC” tab or press the “MEDIA” button repeatedly until the “DISC” tab is selected.

### Control icon screen

▶ AudioCD mode

▶ MP3/WMA discs mode



- ① Random playback
- ② Repeat play
- ③ Pause  
Select  to play
- ④ Setting the sound (→P. 474)
- ⑤ Selecting a track
- ⑥ Selecting a folder

## Selecting, fast forwarding or rewinding a track (Audio CD)

### ■ Selecting a track



Select “<” or “>” on the screen to select the next/previous track.

Press “<” or “>” on the “PRST•TRACK” button or turn the “TUNE/SCROLL” knob to select the desired track number.

### ■ Selecting a track from the track list





**1** Select the track name on the screen to display the CD's track list.

**2** Select the desired track number.

 : Select to move the list up or down by 5 track groups.

“PRST•TRACK” button: Press “<” or “>” on the “PRST•TRACK” button to scroll through the track list one by one.

“TUNE/SCROLL” knob: Turn the knob clockwise or counterclockwise to quickly scroll up or down the track list.

 : If  appears to the right of an item name, the complete name is too long for the screen. Select  to scroll to the end of the name. Select  to move to the beginning of the name.

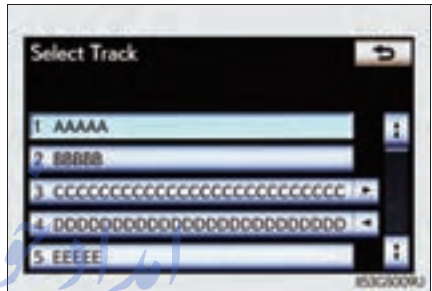

### ■ Fast forwarding or rewinding a track

To fast forward or rewind, press and hold “<” or “>” on the “PRST•TRACK” button.

## Selecting a folder (MP3/WMA discs)



### ■ Selecting a folder

Select “<” or “>” on the screen to select the next/previous folder.





### ■ Selecting a folder from the folder list

1 Select the folder name on the screen to display the following folder list screen.

2 Select the desired folder number to display the folder’s file list. From the file list, select the desired file number.

 : Select to move the list up or down by 5 folder groups.

“TUNE/SCROLL” knob: Turn the knob clockwise or counterclockwise to quickly scroll up or down the folder list.

 : If  appears to the right of an item name, the complete name is too long for the screen. Select  to scroll to the end of the name. Select  to move to the beginning of the name.





## Random playback

### ■ Audio CD

Select "RAND" on the screen.

"RAND" appears on the screen.

To cancel, select "RAND" again.

### ■ MP3/WMA disc

- Playing files from a particular folder in random order

Each time "RAND" is selected, the mode changes as follows:

random (1 folder random) → folder random (1 disc random) → off

- Playing all the files on a disc in random order

Select "RAND" repeatedly until "FLD.RAND" appears on the screen.

To cancel, select "RAND" again.

When a file is skipped or the system is inoperative, select "RAND" to reset.

تلفن شبانه روزی: ۰۲۱-۸۸۶۲۰۸۵

FarmaSOS.com



## Repeating a track

### ■ Audio CD

Select "RPT" on the screen.

"RPT" appears on the screen.

To cancel, select "RPT" again.

### ■ MP3/WMA disc

#### ● Repeating a file

Select "RPT" on the screen.

Each time "RPT" is selected, the mode changes as follows:

- When "RAND" is off  
file repeat → folder repeat → off
- When "RAND" is on  
file → repeat off

#### ● Repeating all of the files in a folder

Select "RPT" repeatedly until "FLD.RPT" appears on the screen.

To cancel, select "RPT" again.

### ■ If you select

The display returns to the previous screen.

### ■ Displaying the title and artist name (Audio CD)

If a CD-TEXT disc is inserted, the title of the disc and track will be displayed. Up to 32 characters can be displayed.

### ■ Error messages

→P. 432

## Playing DVD video

For safety reasons, you can enjoy the visual contents of discs only when the vehicle is completely stopped with the engine switch in ACCESSORY or IGNITION ON mode and the parking brake applied. While driving in DVD video mode, only the DVD's audio can be heard.

When a DVD video disc is inserted while driving, the audio contents of the main feature will automatically be played. However, some discs may not be played from the main story.

Press the "MEDIA" button if a disc has already been loaded in the disc slot.

Select the "DISC" tab or press the "MEDIA" button repeatedly until the "DISC" tab is selected.

امداد خودرو فارما

تلفن شبانه روزی: ۰۲۱-۸۸۶۲۰۸۵

FarmaSOS.com

## Control icon screen

- ▶ Vehicles without a navigation system
- ▶ Vehicles with a navigation system



- ① ② Menu screen appears
- ③ Option screen appears (→P. 422)
- ④ Display menu control key (→P. 423)
- ⑤ Vehicle is completely stopped and the parking brake is applied, the video screen returns
- ⑥ Rewind
- ⑦ Stop
- ⑧ Pause  
Select  to play
- ⑨ Fast forward
- ⑩ Setting the sound (→P. 474)

If  is selected, while watching a DVD, the DVD controls will appear.

If  appears on the screen when a control is selected the operation relevant to the control is not permitted.

تلفن شبانه روزی: ۰۲۱-۸۸۶۲۰۸۵

FarmaSOS.com

## DVD options screen

Select "Options" on "DVD" screen, the following screen appears.

- ▶ Vehicles without a navigation system
- ▶ Vehicles with a navigation system

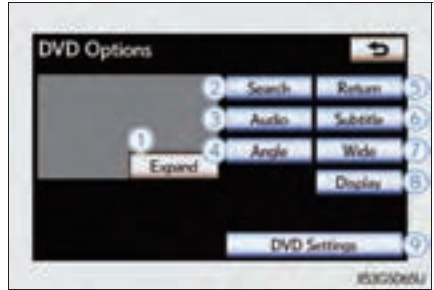
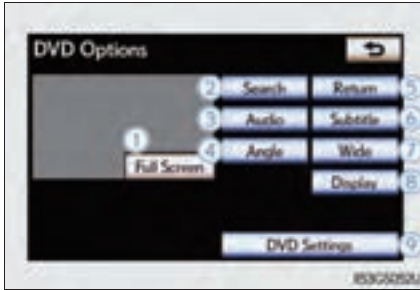







- ① Returns to the full screen (only when the vehicle is completely stopped and the parking brake is applied)
- ② Search by title/group number
- ③ Change audio language
- ④ Change angle
- ⑤ Display the predetermined scene and start playing from there
- ⑥ Change subtitle language
- ⑦ Change screen size
- ⑧ Display the image quality adjustment screen
- ⑨ Change initial setting

If  appears on the screen when a control is selected the operation relevant to the control is not permitted.

## Fast forwarding/rewinding a disc

Select and hold  or  on the control icon screen.

## Using the DVD menu

- 1 Select "Menu" or "Top Menu" on the control icon screen.  
Select  if the menu control key does not appear on the menu screen.
- 2 Select the menu item using , ,  or  and select "Enter".  
:Returns to the previous screen





Note that specific items or the operating method differs from one DVD to another. Refer to the manual that comes with the DVD disc. (The above image is an example.)

## Searching for a desired screen

### ■ Searching by title

- 1 Select "Search" on the "DVD Options" screen.
- 2 Input the desired title number and then select "OK".

: Deletes the last input number

: Returns to the previous screen

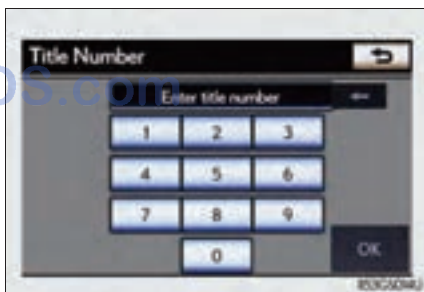

### ■ Searching by chapter

Press "<" or ">" on the "PRST•TRACK" button or turn the "TUNE/SCROLL" knob.

## Changing the subtitle language

- 1 Select "Subtitle" on the "DVD Options" screen.
- 2 Each time you select "Change", the next available language is selected.

The languages available are restricted to those available on the DVD disc.

"Hide": Hides the subtitles

: Returns to the previous screen

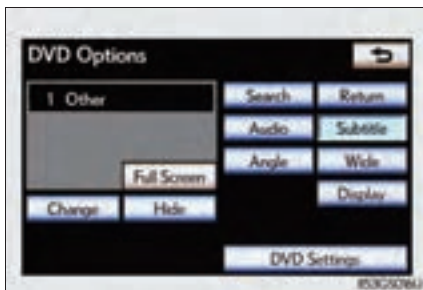

## Changing the audio language

- 1 Select "Audio" on the "DVD Options" screen.
- 2 Each time you select "Change", the next available language is selected.

The languages available are restricted to those available on the DVD disc.

: Returns to the previous screen

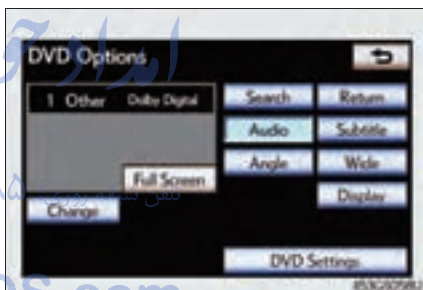

## Changing the angle (if the angle option is available)

- 1 Select "Angle" on the "DVD Options" screen.
- 2 Each time you select "Change", the next available angle is selected.

The angles available are restricted to those available on the DVD disc.

: Returns to the previous screen

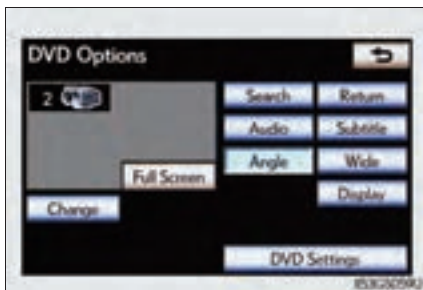

## Changing screen size

1 Select "Wide" on the "DVD Options" screen.

2 Select the desired display. After setting, select "Save".

- ① Displays a 3 : 4 screen, with either side in black
- ② Widens the 3 : 4 screen horizontally to fill the screen
- ③ Widens the 3 : 4 screen vertically and horizontally, in the same ratio, to fill the screen



: Returns to the previous screen

امداد خودرو فارما

تلفن شبانه روزی: ۰۲۱-۸۸۶۲۰۸۵

FarmaSOS.com

## Adjusting the screen

1 Select "Display" on the "DVD Options" screen.

2 Select "<" or ">" to display the desired item to be adjusted, and then select "OK".

The screen goes off when "Screen Off" is selected. To turn the display screen back on, select any button. The selected screen appears.

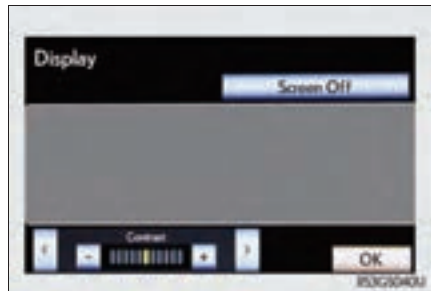

	R	G
Color	Red	Green
	+	-
Tone	Lighter	Darker
Contrast	Weaker	Stronger
Brightness	Darker	Brighter

تلفن شبانه روزی: ۰۲۱-۸۸۶۲۰۸۵

FarmaSOS.com



## Initial DVD settings

### ■ Displaying “DVD Settings” screen

- 1 Select “DVD Settings” on the “DVD Options” screen.
- 2 Select the setting to be changed.

After you change the settings, select “Save”.

“Default”: Restores default settings

: Returns to the previous screen

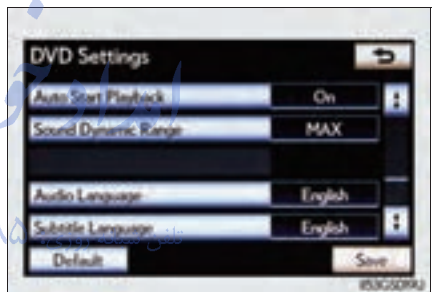
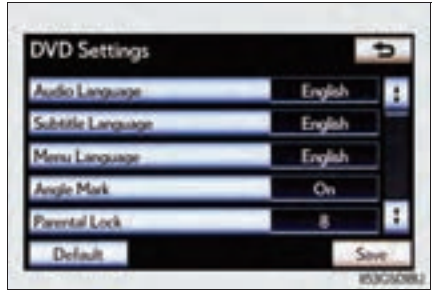

### ■ Setting audio language

- 1 Select “Audio Language” on the “DVD Settings” screen.
- 2 Select the desired language to be heard on the “Audio Language” screen.

If you cannot find the desired language, select “Other” and input the desired language code. (→P. 429)

### ■ Setting subtitle language

- 1 Select “Subtitle Language” on the “DVD Settings” screen.
- 2 Select the desired language to be read on the “Subtitle Language” screen.

If you cannot find the desired language, select “Other” and input the desired language code. (→P. 429)

### ■ Setting menu language

- 1 Select "Menu Language" on the "DVD Settings" screen.
- 2 Select the desired language to be read on the "Menu Language" screen.

If you cannot find the desired language, select "Other" and input the desired language code. (→P. 429)

### ■ Setting angle mark

If the DVD has angle options, you can turn the angle mark on or off.

- 1 Select "Angle Mark" on the "DVD Settings" screen.
- 2 Select "On" or "Off".

### ■ Setting parental lock

- 1 Select "Parental Lock" on the "DVD Settings" screen.
- 2 Input the 4-digit personal code on the "Key Code" screen.  
If you enter wrong numbers, select  to delete the numbers.
- 3 Select a parental level (1-8) on the "Select Restriction Level" screen.  
(→P. 435) ۰۲۱-۸۸۶۲۰۸۵ تلفن شبانه روزی:

### ■ Setting the auto start

Discs that are inserted while the vehicle is in motion will automatically start playing.

- 1 Select "Auto Start Playback" on the "DVD Settings" screen.
- 2 Select "On" or "Off".

### ■ Setting sound dynamic range

The difference between the lowest volume and the highest volume can be adjusted.

- 1 Select "Sound Dynamic Range" on the "DVD Settings" screen.
- 2 Select "MAX", "STD" or "MIN".

### ■ Entering a language code

If you select “Other” on the “Audio Language” screen, “Subtitle Language” screen or “Menu Language” screen you can select a language by entering the 4-digit language code if that language is available.

Input the 4-digit language code and then select “OK”.

 : Deletes the last input digit

 : Returns to the previous screen

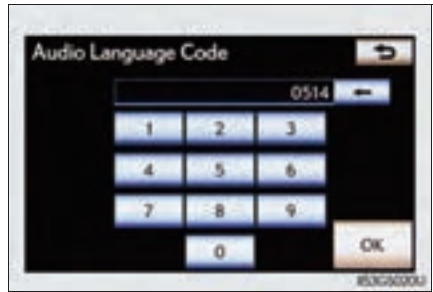

### ● Language codes

Code	Language	Code	Language	Code	Language
0514	English	0207	Bulgarian	0712	Galician
0618	French	0208	Bihari	0714	Guarani
0405	German	0209	Bislama	0721	Gujarati
0920	Italian	0214	Bengali, <small>تلفظ: شبانه روزی</small> Bangla	0801	Hausa
0519	Spanish	0215	Tibetan	0809	Hindi
2608	Chinese	0218	Breton	0818	Croatian
1412	Dutch	0301	Catalan	0821	Hungarian
1620	Portuguese	0315	Corsican	0825	Armenian
1922	Swedish	0319	Czech	0901	Interlingua
1821	Russian	0325	Welsh	0905	Interlingue
1115	Korean	0401	Danish	0911	Inupiak
0512	Greek	0426	Bhutani	0914	Indonesian
0101	Afar	0515	Esperanto	0919	Icelandic
0102	Abkhazian	0520	Estonian	0923	Hebrew
0106	Afrikaans	0521	Basque	1001	Japanese

Code	Language	Code	Language	Code	Language
0113	Amharic	0601	Persian	1009	Yiddish
0118	Arabic	0609	Finnish	1023	Javanese
0119	Assamese	0610	Fiji	1101	Georgian
0125	Aymara	0615	Faroese	1111	Kazakh
0126	Azerbaijani	0625	Frisian	1112	Greenlandic
0201	Bashkir	0701	Irish	1113	Cambodian
0205	Byelorussian	0704	Scottish-Gaelic	1114	Kannada
1119	Kashmiri	1415	Norwegian	1914	Shona
1121	Kurdish	1503	Occitan	1915	Somali
1125	Kirghiz	1513	(Afan) Oromo	1917	Albanian
1201	Latin	1518	Oriya	1918	Serbian
1214	Lingala	1601	Panjabi	1919	Siswati
1215	Laothian	1612	Polish	1920	Sesotho
1220	Lithuanian	1619	Pashto, Pushto	1921	Sundanese
1222	Latvian, Lettish	1721	Quechua	1923	Swahili
1307	Malagasy	1813	Rhaeto-Romance	2001	Tamil
1309	Maori	1814	Kirundi	2005	Telugu
1311	Macedonian	1815	Romanian	2007	Tajik
1312	Malayalam	1823	Kinyarwanda	2008	Thai
1314	Mongolian	1901	Sanskrit	2009	Tigrinya
1315	Moldavian	1904	Sindhi	2011	Turkmen
1318	Marathi	1907	Sango	2012	Tagalog
1319	Malay	1908	Serbo-Croatian	2014	Setswana

Code	Language	Code	Language	Code	Language
1320	Maltese	1909	Sinhalese	2015	Tongan
1325	Burmese	1911	Slovak	2018	Turkish
1401	Nauru	1912	Slovenian	2019	Tsonga
1405	Nepali	1913	Samoaan	2020	Tatar
2023	Twi	2209	Vietnamese	2515	Yoruba
2111	Ukrainian	2215	Volapük	2621	Zulu
2118	Urdu	2315	Wolof		
2126	Uzbek	2408	Xhosa		

#### ■ When a rear passenger selects set up menu

Follow the directions on the warning screen that is displayed.

Under the same condition, the rear passenger can cancel the set up operation from the front seat.

#### ■ Error messages

If "Region Code Error" is displayed, check if the region code printed on the DVD matches the player's region code.

If a different message is displayed: →P. 432

FarmaSOS.com

## CD/DVD player and DVD video disc information

### Error messages

Refer to the following table and take the appropriate measures. If the problem is not rectified, take the vehicle to your Lexus dealer.





The error messages may differ from those shown below depending on the language selected.

Message	Cause	Correction Procedures
No disc found.	There is no disc in the player.	Insert a disc.
Check DISC	<ul style="list-style-type: none"> <li>• The disc is dirty or damaged.</li> <li>• The disc is inserted upside down.</li> <li>• The disc is not playable with the player.</li> </ul>	<ul style="list-style-type: none"> <li>• Clean the disc.</li> <li>• Insert the disc correctly.</li> <li>• Confirm the disc is playable with the player.</li> </ul>
DISC Error	<ul style="list-style-type: none"> <li>• There is a malfunction within the system.</li> <li>• Operation is stopped due to a high temperature inside the player.</li> </ul>	<ul style="list-style-type: none"> <li>• Eject the disc.</li> <li>• Eject the disc and allow the player to cool down.</li> </ul>
No music files found.	This indicates that no playable data is included in the disc.	Eject the disc.

## DVD video discs

- The DVD player conforms to NTSC/PAL color TV formats. DVD video discs conforming to another format such as SECAM cannot be used.
- Region code: Some DVD video discs have a region code indicating the region in which you can use the DVD video disc. If the DVD video disc is not labeled as "ALL" or "1", you cannot use it on this DVD player. If you attempt to play an inappropriate DVD video disc on this player, "Region Code Error" appears on the screen. Even if the DVD video disc does not have a region code, you may not be able to use it.

### ■ Symbols shown on DVD video discs

Symbol	Meaning
NTSC/PAL	Indicates NTSC/PAL format
	Indicates the number of audio tracks
	Indicates the number of language subtitles
	Indicates the number of angles
	Indicates the screen display ratios available Wide screen: 16:9 Standard: 4:3
	Indicates the disc's region code ALL: in all countries Number: region code

### ■ Discs that can be used

Discs with the marks shown below can be used.

Playback may not be possible depending on recording format or disc features, or due to scratches, dirt or deterioration.



Use only discs marked as shown above. The following products may not be playable on your player:

- SACD
- dts CD
- Copy-protected CD
- DVD audio
- Video CD
- DVD-R
- DVD+R
- DVD-RW
- DVD+RW
- DVD-RAM

### ■ CD/DVD player protection feature

To protect the internal components, playback is automatically stopped when a problem is detected.

### ■ If discs are left inside the CD/DVD player or in the ejected position for extended periods

Discs may be damaged and may not play properly.

### ■ Lens cleaners

Do not use lens cleaners. Doing so may damage the CD/DVD player.

امداد خودرو فارما

تلفن شبانه روزی: ۰۸۵ ۲۱۱۸۴۲

FarmaSOS.com



## ■ DVD video disc information

### ● DVD video discs

A DVD video disc is a Digital Versatile Disc that holds video. DVD video discs have adopted "MPEG2", one of the world standards of digital compression technologies. The picture data is compressed by 1/40 on average and stored. Variable rate encoded technology in which the volume of data assigned to the picture is changed depending on the picture format has also been adopted. Audio data is stored using PCM and Dolby Digital, which enables higher quality of sound. Furthermore, multi-angle and multi-language features will also help you enjoy the more advanced technology of DVD video.

### ● Viewer restrictions

This feature limits what can be viewed in conformity with the level of restrictions of the country. The level of restrictions varies depending on the DVD video disc. Some DVD video discs cannot be played at all, or violent scenes are skipped or replaced with other scenes.

Level 1: DVD video discs for children can be played.

Level 2-7: DVD video discs for children and G-rated movies can be played.

Level 8: All types of DVD video discs can be played.

### ● Multi-angle option

You can enjoy the same scene from different angles.

### ● Multi-language option

You can select the subtitle and audio languages. تلفن شبانه رو.

### ● Region codes

The region codes are provided on DVD players and DVD discs. If the DVD video disc does not have the same region code as the DVD player, you cannot play the disc on the DVD player. (→P. 433)

### ● Audio

This DVD player can play linear PCM, Dolby Digital and MPEG audio format DVDs. Other decoded types cannot be played.

### ● Title and chapter

Video and audio programs stored in DVD video discs are divided into parts by title and chapter.

Title: The largest unit of the video and audio programs stored on DVD video discs. Usually, one movie, one album, or one audio program is assigned as a title.

Chapter: A title is comprised of one or more chapters.

### ■ Sound

Dolby Digital

Manufactured under license from Dolby Laboratories.

Dolby and the double-D symbol are trademarks of Dolby Laboratories.

### ■ MP3 and WMA files

MP3 (MPEG Audio LAYER 3) is a standard audio compression format.

Files can be compressed to approximately 1/10 of their original size by using MP3 compression.

WMA (Windows Media Audio) is a Microsoft audio compression format.

This format compresses audio data to a size smaller than that of the MP3 format.

There is a limit to the MP3 and WMA file standards that can be used and to the media/formats on which the files are recorded.

#### ● MP3 file compatibility

- Compatible standards  
MP3 (MPEG1 LAYER3, MPEG2 LSF LAYER3)
- Compatible sampling frequencies  
MPEG1 LAYER3: 32, 44.1, 48 (kHz)  
MPEG2 LSF LAYER3: 16, 22.05, 24 (kHz)
- Compatible bit rates (compatible with VBR)  
MPEG1 LAYER3: 32, 64, 80, 96, 112, 128, 160, 192, 224, 256, 320 (kbps)  
MPEG2 LSF LAYER3: 8, 32, 64, 80, 96, 112, 128, 144, 160 (kbps)
- Compatible channel modes: stereo, joint stereo, dual channel and monaural

- WMA file compatibility

- Compatible standards  
WMA Ver. 7, 8, 9
- Compatible sampling frequencies  
32, 44.1, 48 (kHz)
- Compatible bit rates (only compatible with 2-channel playback)  
Ver. 7, 8: CBR 48, 64, 80, 96, 128, 160, 192 (kbps)  
Ver. 9: CBR 48, 64, 80, 96, 128, 160, 192, 256, 320 (kbps)

- Compatible media

Media that can be used for MP3 and WMA playback are CD-Rs and CD-RWs.

Playback in some instances may not be possible if the CD-R or CD-RW is not finalized. Playback may not be possible or the audio may jump if the disc is scratched or marked with fingerprints.

- Compatible disc formats

The following disc formats can be used:

- Disc formats: CD-ROM Mode 1 and Mode 2  
CD-ROM XA Mode 2, Form 1 and Form 2
- File formats: ISO9660 Level 1, Level 2, (Romeo, Joliet)  
MP3 and WMA files written in any format other than those listed above may not play correctly, and their file names and folder names may not be displayed correctly.

Items related to standards and limitations are as follows:

- Maximum directory hierarchy: 8 levels (including the root)
- Maximum length of folder names/file names: 32 characters
- Maximum number of folders: 192 (including the root)
- Maximum number of files per disc: 255

- File names

The only files that can be recognized as MP3/WMA and played are those with the extension .mp3 or .wma.

- Discs containing multi-session recordings

As the audio system is compatible with multi-sessions, it is possible to play discs that contain MP3 and WMA files. However, only the first session can be played.

- ID3 and WMA tags

ID3 tags can be added to MP3 files, making it possible to record the track title, artist name, etc.

The system is compatible with ID3 Ver. 1.0, 1.1, and Ver. 2.2, 2.3 ID3 tags. (The number of characters is based on ID3 Ver. 1.0 and 1.1.)

WMA tags can be added to WMA files, making it possible to record the track title and artist name in the same way as with ID3 tags.

- MP3 and WMA playback

When a disc containing MP3 or WMA files is inserted, all files on the disc are first checked. Once the file check is finished, the first MP3 or WMA file is played. To make the file check finish more quickly, we recommend you do not write in any files other than MP3 or WMA files or create any unnecessary folders.

Discs that contain a mixture of music data and MP3 or WMA format data cannot be played.

- Extensions

If the file extensions .mp3 and .wma are used for files other than MP3 and WMA files, they may be mistakenly recognized and played as MP3 and WMA files. This may result in large amounts of interference and damage to the speakers.

- Playback

- To play MP3 files with steady sound quality, we recommend a fixed bit rate of at least 128 kbps and a sampling frequency of 44.1 kHz. تلفن
- CD-R or CD-RW playback may not be possible in some instances, depending on the characteristics of the disc.
- There is a wide variety of freeware and other encoding software for MP3 and WMA files on the market, and depending on the status of the encoding and the file format, poor sound quality or noise at the start of playback may result. In some cases, playback may not be possible at all.
- When files other than MP3 or WMA files are recorded on a disc, it may take more time to recognize the disc and in some cases, playback may not be possible at all.
- Microsoft, Windows, and Windows Media are the registered trademarks of Microsoft Corporation in the U.S. and other countries.

### ■ The Gracenote® media database

- Music recognition technology and related data are provided by Gracenote®. Gracenote is the industry standard in music recognition technology and related content delivery. For more information visit [www.gracenote.com](http://www.gracenote.com).



- CD and music-related data from Gracenote, Inc., copyright © 2000 to present Gracenote. Gracenote Software, copyright © 2000 to present Gracenote. One or more patents owned by Gracenote apply to this product and service. See the Gracenote website for a non-exhaustive list of applicable Gracenote patents. Gracenote, CDDDB, MusicID, MediaVOCS, the Gracenote logo and logotype, and the “Powered by Gracenote” logo are either registered trademarks or trademarks of Gracenote in the United States and/or other countries.

### ■ Gracenote® End User License Agreement

This application or device contains software from Gracenote, Inc. of Emeryville, California (“Gracenote”). The software from Gracenote (the “Gracenote Software”) enables this application to perform disc and/or file identification and obtain music-related information, including name, artist, track, and title information (“Gracenote Data”) from online servers or embedded databases (collectively, “Gracenote Servers”) and to perform other functions. You may use Gracenote Data only by means of the intended End-User functions of this application or device.

You agree that you will use Gracenote Data, the Gracenote Software, and Gracenote Servers for your own personal non-commercial use only. You agree not to assign, copy, transfer or transmit the Gracenote Software or any Gracenote Data to any third party.

YOU AGREE NOT TO USE OR EXPLOIT GRACENOTE DATA, THE GRACENOTE SOFTWARE, OR GRACENOTE SERVERS, EXCEPT AS EXPRESSLY PERMITTED HEREIN.

You agree that your non-exclusive license to use the Gracenote Data, the Gracenote Software, and Gracenote Servers will terminate if you violate these restrictions. If your license terminates, you agree to cease any and all use of the Gracenote Data, the Gracenote Software, and Gracenote Servers. Gracenote reserves all rights in Gracenote Data, the Gracenote Software, and the Gracenote Servers, including all ownership rights. Under no circumstances will Gracenote become liable for any payment to you for any information that you provide. You agree that Gracenote, Inc. may enforce its rights under this Agreement against you directly in its own name.

The Gracenote service uses a unique identifier to track queries for statistical purposes. The purpose of a randomly assigned numeric identifier is to allow the Gracenote service to count queries without knowing anything about who you are. For more information, see the web page for the Gracenote Privacy Policy for the Gracenote service.

The Gracenote Software and each item of Gracenote Data are licensed to you "AS IS." Gracenote makes no representations or warranties, express or implied, regarding the accuracy of any Gracenote Data from in the Gracenote Servers. Gracenote reserves the right to delete data from the Gracenote Servers or to change data categories for any cause that Gracenote deems sufficient. No warranty is made that the Gracenote Software or Gracenote Servers are error-free or that functioning of Gracenote Software or Gracenote Servers will be uninterrupted. Gracenote is not obligated to provide you with new enhanced or additional data types or categories that Gracenote may provide in the future and is free to discontinue its services at any time.

GRACENOTE DISCLAIMS ALL WARRANTIES EXPRESS OR IMPLIED, INCLUDING, BUT NOT LIMITED TO, IMPLIED WARRANTIES OF MERCHANTABILITY, FITNESS FOR A PARTICULAR PURPOSE, TITLE, AND NON-INFRINGEMENT. GRACENOTE DOES NOT WARRANT THE RESULTS THAT WILL BE OBTAINED BY YOUR USE OF THE GRACENOTE SOFTWARE OR ANY GRACENOTE SERVER. IN NO CASE WILL GRACENOTE BE LIABLE FOR ANY CONSEQUENTIAL OR INCIDENTAL DAMAGES OR FOR ANY LOST PROFITS OR LOST REVENUES.

copyright © 2000 to present Gracenote

 CAUTION**■ DVD video precaution**

Conversational speech on some DVDs is recorded at a low volume to emphasize the impact of sound effects. If you adjust the volume assuming that the conversations represent the maximum volume level that the DVD will play, you may be startled by louder sound effects or startled when you change to a different audio source.

Loud sounds may have a significant impact on the human body or pose a driving hazard. Keep this in mind when you adjust the volume.

امداد خودرو فارما

تلفن شبانه روزی: ۰۲۱-۸۸۶۲۰۸۵

FarmaSOS.com

 NOTICE

■ Discs and adapters that cannot be used

Do not use the following types of discs, 3 in. (8 cm) disc adapters or Dual Disc. Doing so may damage the player and/or disc insert/eject function.

- Discs that have a diameter that is not 4.7 in. (12 cm)



- Low-quality or deformed discs

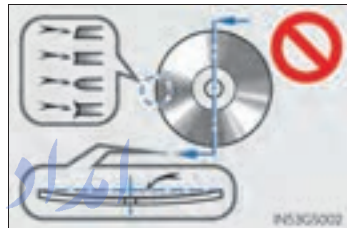

- Discs with a transparent or translucent recording area



- Discs that have tape, stickers or CD-R labels attached to them, or that have had the label peeled off





 NOTICE**■ Player precautions**

Failure to follow the precautions below may result in damage to the discs or the player itself.

- Do not insert anything other than discs into the disc slot.
- Do not apply oil to the player.
- Store discs away from direct sunlight.
- Never try to disassemble any part of the player.

امداد خودرو فارما

تلفن شبانه روزی: ۰۲۱-۸۸۶۲۰۸۵

FarmaSOS.com

## Listening to Bluetooth® audio

The Bluetooth® audio system enables users to enjoy music played on a portable player from the vehicle speaker via wireless communication. This audio system supports Bluetooth®, a wireless data system capable of playing portable audio music without cables. If your portable player does not support Bluetooth®, the Bluetooth® audio system will not function.

Press the “MEDIA” button if a Bluetooth® audio player has already been connected.

Select the “BT Audio” tab or press the “MEDIA” button repeatedly until the “BT Audio” tab is selected.

امداد خودرو فارما

تلفن شبانه روزی: ۰۲۱-۸۸۶۲۰۸۵

FarmaSOS.com







- |   |   |
|---|---|
| ① Folder/album selection                | ⑧ Play/pause                              |
| ② Track selection                       | ⑨ Repeat play                             |
| ③ Displays folder/album list            | ⑩ Track selection/fast forward/<br>rewind |
| ④ Displays track list                   | ⑪ MEDIA button                            |
| ⑤ Connection status                     | ⑫ Power                                   |
| ⑥ Connecting Bluetooth® audio<br>player | ⑬ Volume                                  |
| ⑦ Setting the sound (→P. 474)           | ⑭ Random playback                         |

## Status display

You can check such indicators as signal strength and battery charge on the screen.

- ① Connection status
- ② Battery charge



Indicators	Conditions	
Connection status	Good 	No connection 
Battery charge	Full 	Empty 

تلفن شبانه روزی: ۰۲۱-۸۸۶۲۰۸۵

FarmaSOS.com

## Connecting Bluetooth® audio player

To use the Bluetooth® audio system, you need to enter your portable player into the system. Once registered, you can enjoy your music on the vehicle's audio system. (→P. 543)

For the operation procedure for the portable player, consult your player's accompanying instruction manual.

### ■ When "Bluetooth\* Power" is turned on

When the portable player is on standby for the connection, it will be automatically connected whenever the engine switch is in either ACCESSORY or IGNITION ON mode.

### ■ When "Bluetooth\* Power" is turned off

Manually connect the portable player in accordance with the following procedure.

- 1 Select "Connect".



- 2 Select the desired portable player.

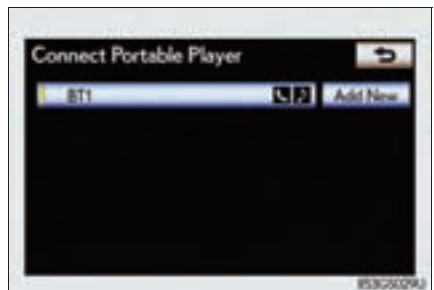

\*: Bluetooth is a registered trademark of Bluetooth SIG, Inc.

- 3 When the connection is completed, this screen is displayed. It is now possible to use the portable player.

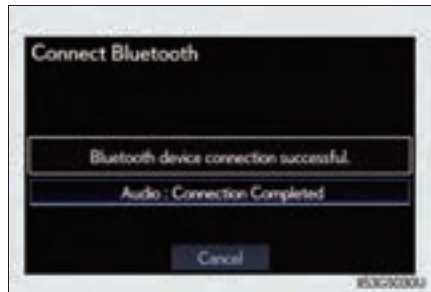

## Playing Bluetooth® audio

Select  to play, select  to pause or press  to play/pause.

Some titles may not be displayed depending on the type of portable player.



تلفن شبانه روزی: ۰۲۱-۸۸۶۲۰۸۵

FarmaSOS.com

## Selecting a track/folder/album

### ■ On the audio top screen

Select “<” or “>” on the screen to select the next/previous folder/album.

### ■ On the playlist screen

- 1 Select the album name on the screen to display the playlist screen.

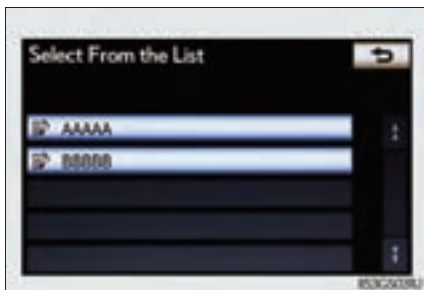

- 2 Select the desired screen button.

If the folder name on the screen is selected, the track list screen is displayed.



- 3 Select the desired track name on the screen.



Select to move the list up or down by 5 track/folder groups.

“PRST•TRACK” button: Press “<” or “>” on the “PRST•TRACK” button to scroll through the track list one by one.

“TUNE/SCROLL” knob: Turn the knob clockwise or counterclockwise to quickly scroll up or down the track/folder list.

If  appears to the right of an item name, the complete name is too long for the screen. Select  to scroll to the end of the name. Select  to move to the beginning of the name.

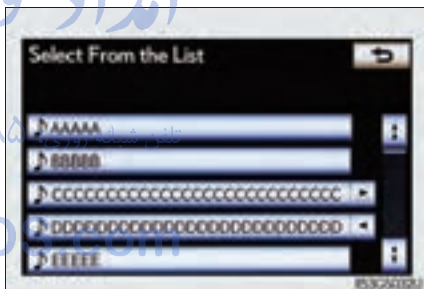

## Selecting, fast forwarding or rewinding a track



### ■ On the audio top screen

Turn the “TUNE/SCROLL” knob or press “<” or “>” on the “PRST•TRACK” button to select the desired track number.

### ■ On the track list screen





**1** Select the track name on the screen to display the following track list screen.

**2** Select the desired track number.

, : Select to move the list up or down by 5 track groups.

“PRST•TRACK” button: Press “<” or “>” on the “PRST•TRACK” button to scroll through the track list one by one.

“TUNE/SCROLL” knob: Turn the knob clockwise or counterclockwise to quickly scroll up or down the track list.

, : If  appears to the right of an item name, the complete name is too long for the screen. Select  to scroll to the end of the name. Select  to move to the beginning of the name.

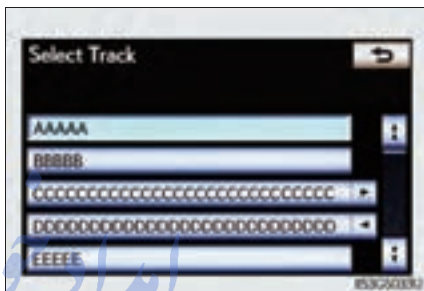

### ■ Fast forwarding and rewinding a track

Press and hold “<” or “>” on the “PRST•TRACK” button to fast forward or rewind.



## Random playback

### ■ Playing the tracks on the album in random order

Select "RAND" on the screen.

Each time "RAND" is selected, the mode changes as follows:  
album random → all track random → off

### ■ Playing tracks from all the albums in random order

Select "RAND" repeatedly until "ALB.RAND" appears on the screen.

To cancel, select "RAND" again.

## Repeat play

### ■ Repeating a track

Select "RPT" on the screen.

Each time "RPT" is selected, the mode changes as follows:  
track repeat → album repeat → off

### ■ Repeating an album

Select "RPT" repeatedly until "ALB.RPT" appears on the screen.

To cancel, select "RPT" again.

### ■ If you select

The display returns to the previous screen.

### ■ Connecting Bluetooth® audio player

- Selecting "Connect Portable Player" on the "Bluetooth\*" screen also connects a Bluetooth® audio player. (→P. 543)
- When none of the selectable portable players have been registered, a screen confirming registration is displayed. The registration method is the same as phone registration. (→P. 536)
- When the currently connected portable player is selected, a screen confirming the selected player's disconnection is displayed. (→P. 536)
- If connection fails once, a changing connection method confirmation screen is displayed. If connection fails 2 or more times, a message will be displayed. When this message is displayed, try again.

\*: Bluetooth is a registered trademark of Bluetooth SIG, Inc.

**■ When using the Bluetooth® audio system**

- In the following conditions, the system may not function.
  - The portable player is turned off
  - The portable player is not connected
  - The portable player battery is low
- There may be a delay if phone connection is carried out during Bluetooth® audio play.
- Depending on the type of portable player that is connected to the system, operation may differ slightly and certain functions may not be available.

**■ Bluetooth® antenna**

The antenna is built into the instrument panel. If the portable player is behind the seat or in the glove box or console box, or is touching or covered by metal objects, connection status may deteriorate.

**■ Battery charge/signal status**

This display may not correspond exactly with the portable player, and this system does not have a charging function.

**■ About Bluetooth®**

Bluetooth is a registered trademark of Bluetooth SIG. Inc.



### ■ Compatible models

Portable players must correspond to the following specifications:

- Bluetooth® specification  
Ver. 1.1 or higher  
(Recommended: Ver. 2.1+EDR or higher)
- Profile
  - A2DP (Advanced Audio Distribution Profile) Ver. 1.0 or higher
  - AVRCP (Audio/Video Remote Control Profile) Ver. 1.0 or higher  
(Recommended: Ver. 1.4 or higher)

However, please note that some functions may be limited depending on the type of portable player. Also, the different screen is displayed depending on which portable player is connecting.

Please go to the website at <http://www.lexus.com/> to find approved portable players for this system.

### ■ Certification

→P. 490

### ■ Reconnecting the portable player

If the portable player is disconnected with a poor reception when the engine switch is in ACCESSORY or IGNITION ON mode, the system automatically reconnects the portable player.

If you have switched off the portable player yourself, follow the instructions below to reconnect:

- Select the portable player again
- Enter the portable player

### ■ When transferring ownership of your vehicle

Be sure to remove the registered portable player from the system. (→P. 538)

### CAUTION

#### ■ While driving

Do not use the portable player or connect the Bluetooth® system.

### NOTICE

#### ■ When leaving the vehicle

Do not leave your portable player in the vehicle. The inside of the vehicle may become hot, causing damage to the portable player.

## Listening to a USB memory

Connecting a USB memory enables you to enjoy music from the vehicle speakers.

Press the “MEDIA” button if a USB memory has already been connected. Select the “USB” tab or press the “MEDIA” button repeatedly until the “USB” tab is selected.

امداد خودرو فارما

تلفن شبانه روزی: ۰۲۱-۸۸۸۶۲۰۸۵

FarmaSOS.com



- |                               |  |
|-------------------------------|--|
| ① Folder/album selection      | ⑦ Repeat play                                  |
| ② Track/file selection        | ⑧ Track and file selection/fast forward/rewind |
| ③ Displays folder/album list  | ⑨ MEDIA button                                 |
| ④ Displays track/file list    | ⑩ Power  |
| ⑤ Setting the sound (→P. 474) | ⑪ Volume                                       |
| ⑥ Play/pause                  | ⑫ Random playback                              |

## Connecting the USB memory

- 1 Open the console box, open the cover and connect a USB memory.

Turn on the power of the USB memory if it is not turned on.

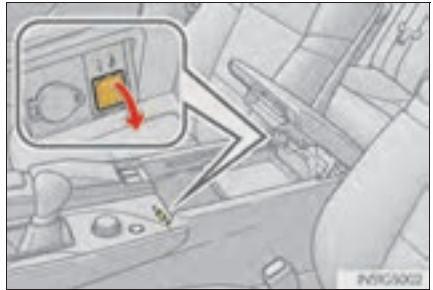

- 2 Press the "MEDIA" button.

## Playing a USB memory

### ■ Play/pause

Select  to play, select  to pause or press  to play/pause.

▶ Tag mode

▶ Folder mode



## Selecting a folder/album

Select "<" or ">" on the screen to select the next/previous folder/album.

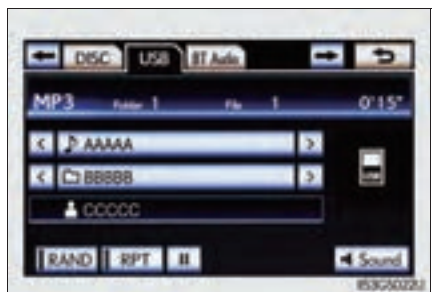

## Selecting a folder, artist or album

- 1 Select the folder/album name on the screen.



- 2 Select the desired tab and select the desired folder, artist or album.

Character screen buttons, "ABC", "DEF" etc., allow a direct jump to list entries that begin with the same letter as the character button.



Each time the same character screen button is selected, the list starting with the subsequent character is displayed.



Select to move the list up or down by 5 folder/artist/album groups.

"TUNE/SCROLL" knob: Turn the knob clockwise or counterclockwise to quickly scroll up or down the folder/artist/album list.



If  appears to the right of an item name, the complete name is too long for the screen. Select  to scroll to the end of the name. Select  to move to the beginning of the name.



## Selecting, fast forwarding or rewinding a file/track

### ■ Selecting one file/track at a time



Select “<” or “>” on the screen to select the next/previous file/track.

Turn the “TUNE/SCROLL” knob or press “<” or “>” on the “PRST•TRACK” button to select the desired file/track.

### ■ Selecting a file/track from the list





1 Select the file/track name on the screen to display the following file/track list screen.

2 Select the desired file/track number.

 ,  : Select to move the list up or down by 5 file/track groups.

“PRST•TRACK” button: Press “<” or “>” on the “PRST•TRACK” button to scroll through the file/track list one by one.

“TUNE/SCROLL” knob: *تلفن شبانه روزی: ۵۵۴۴۴۴۴۴* Turn the knob clockwise or counterclockwise to quickly scroll up or down the file/track list.

 ,  : If  appears to the right of an item name, the complete name is too long for the screen. Select  to scroll to the end of the name. Select  to move to the beginning of the name.



### ■ Fast forwarding or rewinding a file/track

To fast forward or rewind, press and hold “<” or “>” on the “PRST•TRACK” button.



## Random playback

### ■ Playing files/tracks from a particular folder in random order

Select "RAND" on the screen.

Each time "RAND" is selected, the mode changes as follows:

random (1 folder/album random) → folder/album random (all folders/albums random) → off

### ■ Playing the all folders/albums from a USB memory in random order

Select "RAND" repeatedly until "FLD.RAND"/"ALB.RAND" appears on the screen.

To cancel, select "RAND" again.

## Repeat play

### ■ Repeating a file/track

Select "RPT" on the screen.

Each time "RPT" is selected, the mode changes as follows:

● When "RAND" is off  
file/track repeat → folder/album repeat → off

● When "RAND" is on  
file/track repeat → off

### ■ Repeating a folder/album

Select "RPT" repeatedly until "FLD.RPT"/"ALB.RPT" appears on the screen.

To cancel, select "RPT" again.

Available except when random playback is selected

### ■ If you select

The display returns to the previous screen.

### ■ USB memory functions

- When the USB memory is connected and the audio source is changed to USB memory mode, the USB memory will start playing the first file in the first folder. If the same device is removed and reinserted (and the contents have not been changed), the USB memory will resume playing from the same point it was last used.
- Depending on the USB memory that is connected to the system, certain functions may not be available. Disconnecting the device and reconnecting it once again may resolve some malfunctions.

### ■ When using a USB memory

You may be unable to use the instrument panel power outlet if the USB memory is connected to the USB port at the same time.

### ■ Error messages for USB memory

“USB Error”: This indicates a problem in the USB memory or its connection.

“No music files found.”: This indicates that no MP3/WMA files are included in the USB memory.

### ■ USB memory

- Compatible devices تلفن شبانه روزی: ۰۸۵-۸۸۶۲۰۸۵-۲۱  
USB memory that can be used for MP3 and WMA playback.

#### ● Compatible device formats

The following device formats can be used:

- USB communication formats: USB2.0 HS (480 Mbps) and FS (12 Mbps)
- File formats: FAT16/32 (Windows)
- Correspondence class: Mass storage class

MP3 and WMA files written in any format other than those listed above may not play correctly, and their file names and folder names may not be displayed correctly.

Items related to standards and limitations are as follows:

- Maximum directory hierarchy: 8 levels
- Maximum number of folders in a device: 3000 (including the root)
- Maximum number of files in a device: 9999
- Maximum number of files per folder: 255

- MP3 and WMA files
 

MP3 (MPEG Audio LAYER 3) is a standard audio compression format. Files can be compressed to approximately 1/10 of their original size using MP3 compression.

WMA (Windows Media Audio) is a Microsoft audio compression format. This format compresses audio data to a size smaller than that of the MP3 format. There is a limit to the MP3 and WMA file standards that can be used and to the media/formats on which the files are recorded.
- MP3 file compatibility
  - Compatible standards  
MP3 (MPEG1 AUDIO LAYERII, III, MPEG2 AUDIO LAYERII, III, MPEG2.5)
  - Compatible sampling frequencies  
MPEG1 AUDIO LAYERII, III: 32, 44.1, 48 (kHz)  
MPEG2 AUDIO LAYERII, III: 16, 22.05, 24 (kHz)
  - Compatible bit rates (compatible with VBR)  
MPEG1 AUDIO LAYERII, III: 32-320 (kbps)  
MPEG2 AUDIO LAYERII, III: 8-160 (kbps)
  - Compatible channel modes: stereo, joint stereo, dual channel and monaural
- WMA file compatibility
  - Compatible standards  
WMA Ver. 9
  - Compatible sampling frequencies  
HIGH PROFILE 32, 44.1, 48 (kHz)
  - Compatible bit rates  
HIGH PROFILE 48-320 (kbps, VBR)
- File names
 

The only files that can be recognized as MP3/WMA and played are those with the extension .mp3 or .wma.
- ID3 and WMA tags
 

ID3 tags can be added to MP3 files, making it possible to record the track title, artist name, etc.

The system is compatible with ID3 Ver. 1.0, 1.1, and Ver. 2.2, 2.3, 2.4 ID3 tags. (The number of characters is based on ID3 Ver. 1.0 and 1.1.)

WMA tags can be added to WMA files, making it possible to record the track title and artist name in the same way as with ID3 tags.

- MP3 and WMA playback
  - When a device containing MP3 or WMA files is connected, all files in the USB memory device are checked. Once the file check is finished, the first MP3 or WMA file is played. To make the file check finish more quickly, we recommend that you do not include any files other than MP3 or WMA files or create any unnecessary folders.
  - When the USB device is connected and the audio source is changed to USB memory mode, the USB device will start playing the first file in the first folder. If the same device is removed and reinserted (and the contents have not been changed), the USB device will resume play from the same point in which it was last used.
- Extensions  
If the file extensions .mp3 and .wma are used for files other than MP3 and WMA files, they will be skipped (not played).
- Playback
  - To play MP3 files with steady sound quality, we recommend a fixed bit rate of at least 128 kbps and a sampling frequency of 44.1 kHz.
  - There is a wide variety of freeware and other encoding software for MP3 and WMA files on the market, and depending on the status of the encoding and the file format, poor sound quality or noise at the start of playback may result. In some cases, playback may not be possible at all.
  - Microsoft, Windows, and Windows Media are registered trademarks of Microsoft Corporation in the U.S.A. and other countries.

 CAUTION

## ■ While driving

Do not connect an USB memory or operate the controls.

 NOTICE

## ■ To prevent damage to the USB memory or its terminal

- Do not leave USB memory in the vehicle. The temperature inside of the vehicle may become high, resulting in damage to the USB memory.
- Do not push down on or apply unnecessary pressure to the USB memory while it is connected.
- Do not insert foreign objects into the port.

امداد خودرو فارما

تلفن شبانه روزی: ۰۲۱-۸۸۶۲۰۸۵

FarmaSOS.com

## Listening to an iPod

Connecting an iPod enables you to enjoy music from the vehicle speakers.

Press the “MEDIA” button if an iPod has already been connected.

Select the “iPod” tab or press the “MEDIA” button repeatedly until the “iPod” tab is selected.

امداد خودرو فارما

تلفن شبانه روزی: ۰۲۱-۸۸۶۲۰۸۵

FarmaSOS.com

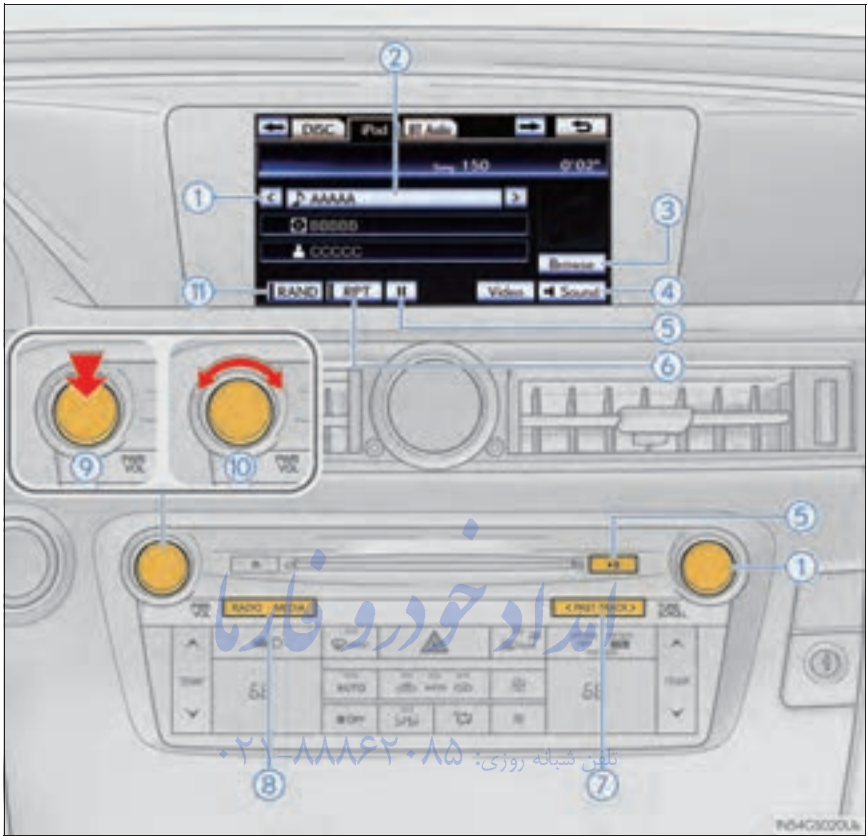

- |                               |                                       |
|-------------------------------|---------------------------------------|
| ① Track selection             | ⑦ Track selection/fast forward/rewind |
| ② Displays track list         | ⑧ MEDIA button                        |
| ③ Selecting a play mode       | ⑨ Power                               |
| ④ Setting the sound (→P. 474) | ⑩ Volume                              |
| ⑤ Play/pause                  | ⑪ Random playback                     |
| ⑥ Repeat play                 |                                       |

## Connecting an iPod

- 1 Open the console box, open the cover and connect an iPod using an iPod cable.

Turn on the power of the iPod if it is not turned on.



- 2 Press the "MEDIA" button.

# امداد خودرو فارما

تلفن شبانه روزی: ۰۲۱-۸۸۸۶۲۰۸۵

[FarmaSOS.com](http://FarmaSOS.com)



## Cover art display settings

When the track currently being played has cover art data, it can be displayed.

- 1 Press the "MENU" button on the Remote Touch and select "Setup" on the "Menu" screen.
- 2 Select "Audio" on the "Setup" screen.
- 3 Select "iPod Settings".

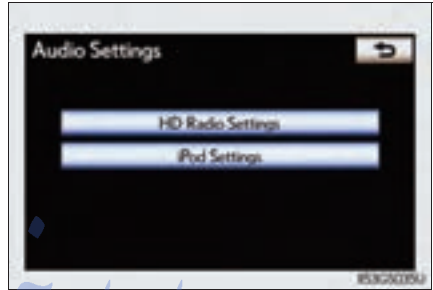

- 4 Select "Display Cover Art".



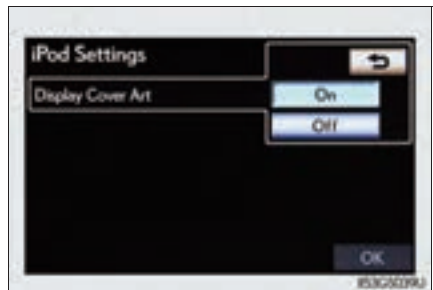

- 5 Select "On" or "Off".



- 6 After iPod setting has been changed, select "OK".

## Playing iPod

### ■ Play/pause

Select  to play, select  to pause or press  to play/pause.



### ■ Selecting a play mode

- 1 Select "Browse".



- 2 Select the desired play mode.

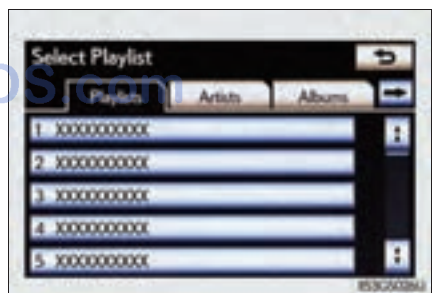



## Random playback

### ■ Playing tracks in random order

Select "RAND" on the screen.

Each time "RAND" is selected, the mode changes as follows:  
track shuffle → album shuffle → off

### ■ Playing the albums in random order

Select "RAND" repeatedly until "ALB.RAND" appears on the screen.

To cancel, select "RAND" again.

## Repeat play

Select "RPT" on the screen.

"RPT" appears on the screen.

To cancel, select "RPT" again.

### ■ If you select

The display returns to the previous screen.

### ■ About iPod

Made for



iPod



iPhone

- "Made for iPod" and "Made for iPhone" mean that an electronic accessory has been designed to connect specifically to iPod, or iPhone, respectively, and has been certified by the developer to meet Apple performance standards.
- Apple is not responsible for the operation of this device or its compliance with safety and regulatory standards. Please note that the use of this accessory with iPod or iPhone may affect wireless performance.
- iPhone, iPod, iPod classic, iPod nano and iPod touch are trademarks of Apple Inc., registered in the U.S. and other countries.

### ■ iPod cover art

- Depending on the iPod and the songs in the iPod, iPod cover art may be displayed. This function can be changed to “On” or “Off”. (→P. 467)
- It may take time to display iPod cover art, and the iPod may not be operated while the cover art display is in process.
- Only iPod cover art that is saved in JPEG format can be displayed.

### ■ iPod functions

- When the iPod connected to the system includes iPod video, the system can only output the sound by selecting “Video” on the “iPod” screen.
- Depending on the iPod, the video sound may not be able to be heard.
- When an iPod is connected and the audio source is changed to iPod mode, the iPod will resume play from the same point in which it was last used.
- Depending on the iPod that is connected to the system, certain functions may not be available. If a function is unavailable due to a malfunction (as opposed to a system specification), disconnecting the device and reconnecting it once again may resolve the problem.

### ■ When using an iPod

You maybe unable to use the instrument panel power outlet if the iPod is connected to the USB port at the same time.

### ■ Battery charge

When an iPod is connected using a genuine iPod cable, the iPod starts charging its battery.

### ■ Error messages for iPod

“iPod Error”: This indicates a problem in the iPod or its connection.

“No music files found.”: This indicates that there is no music data in the iPod.

“Please check the iPod firmware version.”:

This indicates that the software version is not compatible. Perform the iPod firmware updates and try again.

“iPod authorization failed.”: This indicates that it failed to authorize the iPod. Please check your iPod.

### ■ Compatible models

The following iPod<sup>®</sup>, iPod nano<sup>®</sup>, iPod classic<sup>®</sup>, iPod touch<sup>®</sup> and iPhone<sup>®</sup> devices can be used with this system.

### ■ Made for

- iPod touch (4th generation)
- iPod touch (3rd generation)
- iPod touch (2nd generation)
- iPod touch (1st generation)
- iPod classic
- iPod with video
- iPod nano (6th generation)
- iPod nano (5th generation)
- iPod nano (4th generation)
- iPod nano (3rd generation)
- iPod nano (2nd generation)
- iPod nano (1st generation)
- iPhone 4
- iPhone 3GS
- iPhone 3G
- iPhone

امداد خودرو فارما

Depending on differences between models or software versions etc., some models might be incompatible with this system.

تلفن شبانه روزی: ۰۲۱-۸۸۶۲۰۸۵

FarmaSOS.com

 CAUTION

## ■ While driving

Do not connect an iPod or operate the controls.

 NOTICE

## ■ To prevent damage to the iPod or its terminal

- Do not leave the iPod in the vehicle. The temperature inside the vehicle may become high, resulting in damage to the iPod.
- Do not push down on or apply unnecessary pressure to the iPod while it is connected.
- Do not insert foreign objects into the port.

امداد خودرو فارما

تلفن شبانه روزی: ۰۲۱-۸۸۶۲۰۸۵

FarmaSOS.com

## Optimal use of the audio/video system

Select **Sound** to adjust the sound settings.



### ■ “Sound” tab

- ① ② ③ Select “-” or “+” to adjust the treble, mid or bass.
- ④ ⑤ Select “Front” or “Rear” to adjust the front/rear audio balance.
- ⑥ ⑦ Select “L” or “R” to adjust the left/right audio balance.

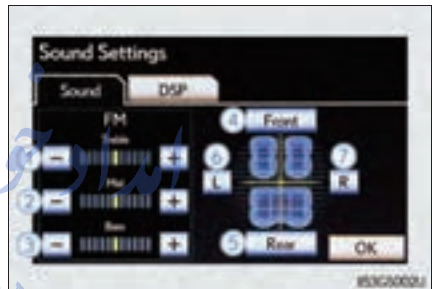

### ■ “DSP” tab

- ① Automatic Sound Levelizer (ASL) on/off
- ② Surround on/off

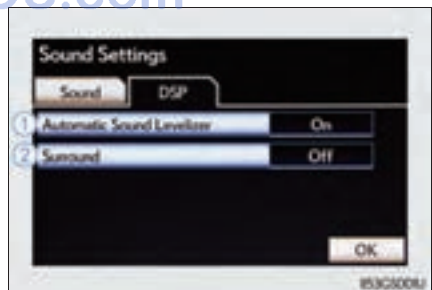

After sound setting has been changed, select “OK”.



**■ The sound quality level is adjusted individually**

The treble, mid and bass levels can be adjusted for the each audio mode separately.

**■ About Automatic Sound Levelizer (ASL)**

ASL automatically adjusts the volume and tone quality according to the vehicle speed, wind noise or other noise.

امداد خودرو فارما

تلفن شبانه روزی: ۰۲۱-۸۸۸۶۲۰۸۵

FarmaSOS.com

## Using the AUX port

This port can be used to connect a portable audio device and listen to it through the vehicle's speakers.

- 1 Open the console box, open the cover and connect the portable audio device.

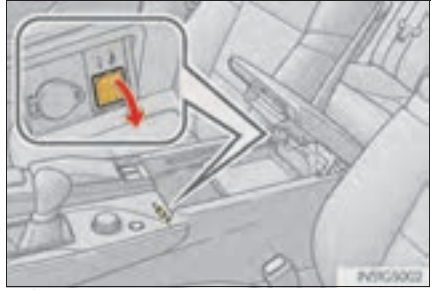

- 2 Press the "MEDIA" button.



- 3 Select the "AUX" tab on the screen or press the "MEDIA" button repeatedly to change to AUX mode.

### ■ Operating portable audio devices connected to the audio system

The volume can be adjusted using the vehicle's audio controls. All other adjustments must be made on the portable audio device itself.

### ■ When using a portable audio device connected to the power outlet

Noise may occur during playback. Use the power source of the portable audio device.

## Using the rear seat audio controls\*

Some front audio features can be controlled from the rear seats.



- ① Display
- ② Power on/off
- ③ Selecting an audio source
- ④ Volume up/down
- ⑤ Selecting a track or file etc.
- ⑥ Selecting a preset station or folder etc.

## Turning the power on/off

Press **PWR** to turn the front audio system on.

Pressing the button again turns the system off.

## Changing the audio source

Press **MODE** to change the audio source. The audio source as follows each time the button is pressed. If no discs are inserted in the player, or if the external device is not connected, that mode will be skipped.

FM → SAT → Apps → DVD player → iPod or USB memory →  
Bluetooth® audio player → AUX → AM

## Adjusting the volume

Press “^” on  to increase the volume and “v” to decrease the volume.

Press and hold the button to continue increasing or decreasing the volume.

## Selecting a radio station

### ■ Select a radio station

1 Press **MODE** to select a frequency band.

2 Press “^” or “v” on  to seek the frequency.

To scan for receivable stations, press and hold  until you hear a beep.

### ■ Select a preset station

1 Press **MODE** to select a frequency band.

2 Press “^” or “v” on  to select a preset station.

## Selecting a track

### ■ Audio CD

1 Press **MODE** to select the DVD player.

2 Press “^” or “v” on  to select a track.

### ■ Bluetooth® audio player

1 Press **MODE** to select the Bluetooth® audio player.

2 Press “^” or “v” on  to select an folder.

3 Press “^” or “v” on  to select a file.

### ■ iPod

1 Press **MODE** to select the iPod.



2 Press “^” or “v” on  to select a file.

## Selecting a chapter (DVD video mode)



- 1 Press **MODE** to select the DVD player.
- 2 Press “^” or “v” on  to select a chapter.

## Selecting a file

### ■ MP3 disc or WMA disc

- 1 Press **MODE** to select the DVD player.
- 2 Press “^” or “v” on  to select a folder.
- 3 Press “^” or “v” on  to select a file.

### ■ USB memory

- 1 Press **MODE** to select the USB memory.
- 2 Press “^” or “v” on  to select a folder.
- 3 Press “^” or “v” on  to select a file.

### ■ Fast forwarding or rewinding a chapter or file

Press and hold “^” or “v” on



### ■ Button lock function

To prevent inadvertent operation, some buttons on the rear armrest can be locked. (→P. 364)

### ■ Rear control panel illumination off function

Control panel illumination on the rear armrest can be turned off. (→P. 364)

### ■ When “ERROR”, “WAIT” or “NO MUSIC” is shown on the display

Refer to the following and take the appropriate measures. If the problem is not rectified, take the vehicle to your Lexus dealer.

“ERROR”: This indicates a trouble either in the disc or inside the player. The disc may be dirty, damaged, or inserted up-side down.

“WAIT”: Operation is stopped due to a high temperature inside the player. Eject the disc and allow the player to cool down.

“NO MUSIC”: This indicates that an MP3/WMA file is not included in the disc.

تلفن شبانه روزی: ۰۲۱-۸۸۶۲۰۸۵

FarmaSOS.com

## Using the steering wheel audio switches

Some audio features can be controlled using the switches on the steering wheel.

- ① Radio mode: Selects a radio station

Audio CD mode:  
Selects a track

MP3/WMA disc mode:  
Selects a file and folder

DVD mode: Selects a chapter

Bluetooth® audio mode:  
Selects a track and album

iPod mode: Selects a track

USB memory mode:  
Selects a file and folder

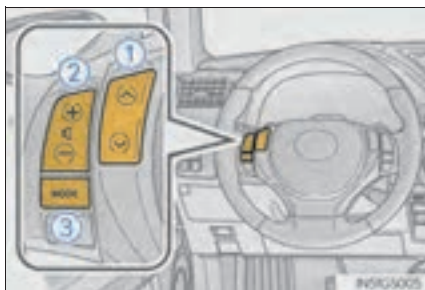

- ② Volume
- ③ Turns the power on, selects audio source

تلفن شبانه روزی: ۰۲۱-۸۸۶۲۰۸۵

ParmaSOS.com



## Turning on the power



Press  when the audio system is turned off.

## Changing the audio source

Press the  to select an audio mode.

Each press changes the mode sequentially if the desired mode is ready to use.

## Adjusting the volume

Press  to increase the volume and  to decrease the volume.

Hold down the switch to continue increasing or decreasing the volume.



## Silencing a sound or pause the current operation

Press and hold .

To cancel, press and hold  again. *تلفن شبانه روزی: ۸۵*

## Selecting the preset station/channel (radio)

**1** Press  to select the radio mode.

**2** Press  or  to select.



## Seeking a radio station/channel

**1** Press  to select the radio mode.

**2** Press and hold the  or  switch until you hear a beep.



To cancel, press either switch.

### Selecting a track/file or chapter



- 1 Press  to select the audio CD, MP3/WMA disc, DVD, Bluetooth<sup>®</sup> audio, iPod, or USB memory mode.
- 2 Press  or  to select.

To return to the beginning of the current track, file or chapter, press the  switch once quickly.

### Selecting an album

- 1 Press  to select Bluetooth<sup>®</sup> audio or USB memory mode.
- 2 Press and hold  or  until a beep is heard to select.

### Selecting a folder

- 1 Press  to select the MP3/WMA disc or USB memory mode.
- 2 Press and hold  or  until a beep is heard to select.

#### CAUTION

##### To reduce the risk of an accident

Exercise care when operating the audio switches on the steering wheel.

## Hands-free system (for cellular phone)

The hands-free system is a function that allows you to use your cellular phone without touching it.

This system supports Bluetooth® cellular phones. Bluetooth® is a wireless data system that allows a cellular phone to wirelessly connect to the hands-free system and outgoing/incoming calls.

The illustrations of the hands-free system screens shown here may slightly vary depending on the type of the system.

Vehicles with a navigation system: The hands-free system function can be displayed and operated on the “Side Display”. For details, refer to the “Navigation System Owner’s Manual”.

امداد خودرو فارما

تلفن شبانه روزی: ۰۲۱-۸۸۶۲۰۸۵

FarmaSOS.com

## Telephone switch

- ① Off hook switch
  - Sending
  - Receiving
  - "Phone" screen display
- ② On hook switch
  - End call
  - Refuse call

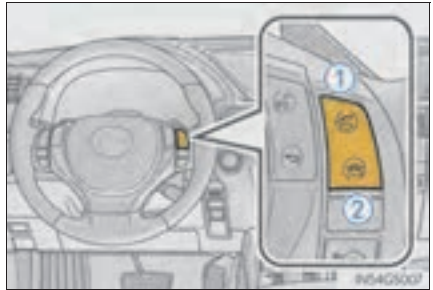

## Microphone

You can use the microphone when talking on the phone.



The person you are speaking to can be heard from the front speakers.



To use the hands-free system, you must register your Bluetooth® phone in the system. (→P. 494)

## Steering switch

### ① Adjusting the volume

Press  to increase the volume and  to decrease the volume. Hold the switch in that position to continue increasing or decreasing the volume.

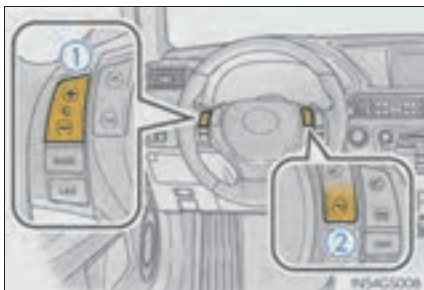

### ② Back switch

Press .

To return to the previous screen.

## Status display

You can check indicators such as signal strength and battery charge on the "Phone" screen.





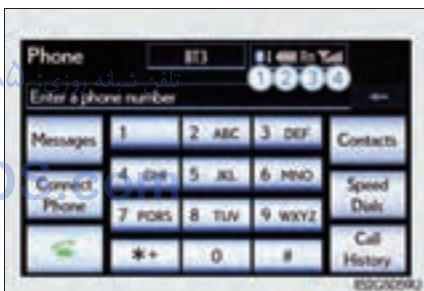

### ① Connection status

### ② Battery charge

### ③ Call area

### ④ Signal strength



Indicators	Conditions	
Connection status	Good 	↔ No connection 
Battery charge	Full 	↔ Empty 
Call area	"Rm": Roaming area	
Signal strength	Excellent 	↔ Poor 

### ■ When using the hands-free system

- The audio system is muted when making a call.
- If both parties speak at the same time, it may be difficult to hear.
- If the incoming call volume is overly loud, an echo may be heard.
- Try to face toward the microphone as much as possible when speaking.
- In the following circumstances, it may be difficult to hear the other party:
  - When driving on unpaved roads
  - When driving at high speeds
  - If a window is open
  - If the air conditioning is blowing directly on the microphone
  - If the air conditioning is set to high
  - There is an effect from the network of the cellular phone

### ■ Conditions under which the system will not operate

- If using a cellular phone that does not support Bluetooth®
- If the cellular phone is turned off
- If you are outside service range
- If the cellular phone is not connected
- If the cellular phone's battery is low
- When the cellular phone is not connected, "No connect" is displayed.

### ■ Bluetooth® antenna

The antenna is built into the instrument panel. If the cellular phone is behind the seat or in the console box, or touching or covered by metal objects, connection status may deteriorate.

### ■ Battery charge/Signal status

- This display may not correspond exactly with the cellular phone itself.
- When the cellular phone is out of the service area or in a place inaccessible by radio waves, "No Service" is displayed.

### ■ When using Bluetooth® audio and hands-free system at the same time

The following problems may occur.

- The Bluetooth® connection may be cut.
- Noise may be heard on the Bluetooth® audio playback.

### ■ About the phonebook in this system

The following data is stored for every registered phone. When another phone is connecting, you cannot read the registered data.

- Phonebook data
- Call history date
- Speed dial date
- Image data
- Messages
- Quick reply messages
- All phone settings

When you delete the phone, the above-mentioned data is also deleted.

### ■ When you release your car

Be sure to initialize your data. (→P. 328)

### ■ About Bluetooth®

Bluetooth is a registered trademark of Bluetooth SIG. Inc.



FarmaSOS.com

### ■ Compatible models

This system supports the following service.

- Bluetooth® Specification Ver. 1.1 or higher (Recommended: Ver. 2.1+EDR or higher)
- Profiles
  - HFP (Hands Free Profile) Ver. 1.0 or higher (Recommended: Ver. 1.5 or higher)
  - OPP (Object Push Profile) Ver. 1.1 or higher
  - PBAP (Phone Book Access Profile) Ver. 1.0 or higher
  - MAP (Message Access Profile) Ver. 1.0 or higher
  - SPP (Serial Port Profile) Ver. 1.1 or higher\*

\*: This profile is necessary when using Apps. For details, refer to the "Navigation System Owner's Manual"

If your cellular phone does not support HFP, you cannot enter the Bluetooth® phone, and take OPP, PBAP, MAP or SPP service individually.

If the connected Bluetooth® phone version is older than recommended or incompatible, this function may not be used.

Please go to <http://www.lexus.com/> to find approved Bluetooth® phones for this system.

### ■ Certification

FCC ID:AJDK041

IC:775E-K041

تلفن شبانه روزی: ۰۲۱-۸۸۶۲۰۸۵

This device complies with Part 15 of FCC Rules and Industry Canada licence-exempt RSS standard(s). Operation is subject to the following two conditions: (1) this device may not cause interference, and (2) this device must accept any interference, including interference that may cause undesired operation of this device.

Le présent appareil est conforme aux la partie 15 des règles de la FCC et CNR d'Industrie Canada applicables aux appareils radio exempts de licence. L'exploitation est autorisée aux deux conditions suivantes: (1) l'appareil ne doit pas produire de brouillage, et (2) l'utilisateur de l'appareil doit accepter tout brouillage radioélectrique subi, même si le brouillage est susceptible d'en compromettre le fonctionnement.

For vehicles sold in Canada:

This device complies with RSS-310 of Industry Canada. Operation is subject to the condition that this device does not cause harmful interference.

Cet appareil est conforme au CNR-310 d'Industrie Canada. Son exploitation est autorisée sous réserve que l'appareil ne cause pas de brouillage préjudiciable.



**⚠ CAUTION****■ FCC WARNING**

This equipment complies with FCC/IC radiation exposure limits set forth for an uncontrolled environment and meets the FCC radio frequency (RF) Exposure Guidelines in Supplement C to OET65 and RSS-102 of the IC radio frequency (RF) Exposure rules. This equipment has very low levels of RF energy that it deemed to comply without maximum permissive exposure evaluation (MPE). But it is desirable that it should be installed and operated keeping the radiator at least 7.9 in. (20 cm) or more away from person's body (excluding extremities: hands, wrists, feet and ankles).

Cet équipement est conforme aux limites d'exposition aux rayonnements énoncées pour un environnement non contrôlé et respecte les règles les radioélectriques (RF) de la FCC lignes directrices d'exposition dans le Supplément C à OET65 et d'exposition aux fréquences radioélectriques (RF) CNR-102 de l'IC. Cet équipement émet une énergie RF très faible qui est considérée conforme sans évaluation de l'exposition maximale autorisée. Cependant, cet équipement doit être installé et utilisé en gardant une distance de 20 cm ou plus entre le dispositif rayonnant et le corps (à l'exception des extrémités: mains, poignets, pieds et chevilles).

**► For vehicles sold in the U.S.A.**

Changes or modifications not expressly approved by the party responsible for compliance could void the user's authority to operate the equipment.

This transmitter must not be co-located or operated in conjunction with any other antenna or transmitter.

**⚠ CAUTION****► For vehicles sold in Canada**

Tout changement ou toute modification de la construction non approuvé expressément par l'abonné responsable de la conformité risque d'annuler l'autorité de l'utilisateur d'exploiter l'équipement.

Cet émetteur ne doit pas être co-implanté ou actionné en même temps qu'aucune autre antenne ou émetteur.

Under Industry Canada regulations, this radio transmitter may only operate using an antenna of a type and maximum (or lesser) gain approved for the transmitter by Industry Canada. To reduce potential radio interference to other users, the antenna type and its gain should be so chosen that the equivalent isotropically radiated power (e.i.r.p.) is not more than that necessary for successful communication. Conformément à la réglementation d'Industrie Canada, le présent émetteur radio peut fonctionner avec une antenne d'un type et d'un gain maximal (ou inférieur) approuvé pour l'émetteur par Industrie Canada. Dans le but de réduire les risques de brouillage radioélectrique à l'intention des autres utilisateurs, il faut choisir le type d'antenne et son gain de sorte que la puissance isotrope rayonnée équivalente (p.i.r.e.) ne dépasse pas l'intensité nécessaire à l'établissement d'une communication satisfaisante.

**■ Caution while driving**

Do not use the cellular phone or connect the Bluetooth® system.

**⚠ NOTICE****■ When leaving the vehicle**

Do not leave your cellular phone in the vehicle. The inside of the vehicle may become hot, causing damage to the phone.

## Using a Bluetooth® phone

- ① Device name
- ② Bluetooth® connection status
- ③ Character deletion
- ④ Make a call



To display the screen shown above, press the “MENU” button on the Remote Touch, then select “Phone” or press  on the steering wheel.

امداد خودرو فارما

تلفن شبانه روزی: ۰۲۱-۸۸۶۲۰۸۵

FarmaSOS.com

## Registering a Bluetooth® phone

You can register up to 5 phones in the system.

**1** Display the “Phone” screen. (→P. 493)

**2** Select “Yes”.

If 5 Bluetooth® devices have already been registered, a registered device needs to be deleted. (→P. 497)



**3** Input the passcode displayed on the screen into your phone.

For the operation of the phone, see the manual that comes with your cellular phone.

A passcode is not required for SSP (Secure Simple Pairing) compatible Bluetooth® phones. Depending on the type of Bluetooth® phone being connected, a message confirming registration may be displayed on the Bluetooth® phone's screen. Respond and operate the Bluetooth® phone according to the confirmation message.

If you want to cancel it, select “Cancel”.

If a completion message is displayed, registration is complete.

If an error message is displayed, follow the guidance on the screen to try again.

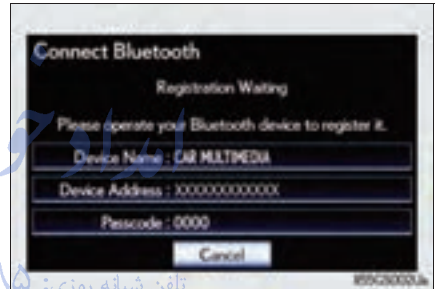

## Bluetooth® phone connection

There are two connection methods available – automatic and manual.

### ■ Automatic

When you register your phone, auto connection will be activated. Always set it to this mode and leave the Bluetooth® phone on the place where connection can be established.

When the engine switch is turned to ACCESSORY or IGNITION ON mode, the system will search for a nearby cellular phone you have registered. The system will connect with the phone that was last connected, if it is nearby.

When “Display Phone Status” is set to “On”, the connection status is displayed. (→P. 546)

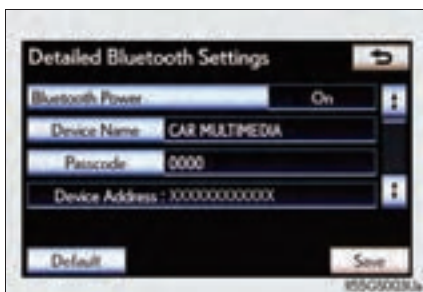

### ■ Manual

When the auto connection has failed or “Bluetooth\* Power” is turned off, you must connect Bluetooth® manually.

- 1 Display the “Phone” screen. (→P. 493)
- 2 Select “Connect Phone”.



- 3 Select the screen button corresponding to the desired phone connection.

When the cellular phone's device name has not been able to be obtained, “Device 1” to “Device 5” will be displayed in the order the phones were registered.



- 4 This screen is displayed.  
If a completion message is displayed, connection is complete.



\*: Bluetooth is a registered trademark of Bluetooth SIG, Inc.

**■ Reconnecting to the Bluetooth® phone**

If the system cannot connect due to poor signal strength with the engine switch in ACCESSORY or IGNITION ON mode, the system will automatically attempt to reconnect.

If the phone is turned off, the system will not attempt to reconnect. In this case, it must be connected manually, or the phone must be re-selected or re-entered.

**■ Connecting the phone while Bluetooth® audio is playing**

- Bluetooth® audio will stop temporarily.
- It may take time to connect.

**■ Connecting the phone while another Bluetooth® device is connected**

When another Bluetooth® device is currently connected, a confirmation message will be displayed. To disconnect the Bluetooth® device, select “Yes”.

**■ Connecting the phone while 5 Bluetooth® devices have already been registered**

When 5 Bluetooth® devices have already been registered, a registered device needs to be deleted. Select “Yes” to delete one or more. Select the device to be deleted, then select “Remove”, and “Yes”.

**■ If the Bluetooth® phone has a Bluetooth® audio function**

When the Bluetooth® phone to be registered has a Bluetooth® audio function, this audio function will be registered automatically at the same time and confirmation message may be displayed. If this screen is displayed, select “Yes” to connect the audio function or select “No” to cancel the connection.

## Making a call

Once the Bluetooth® phone is registered, you can make a call using the following procedure:

### ■ Dialing

1 Display the “Phone” screen. (→P. 493)

2 Input the phone number.

To delete the inputted phone number, select .



3 Select  or press  on the steering wheel.

### ■ Dialing from the phonebook

You can dial a number from the phonebook data imported from your cellular phone. The system has one phonebook for each phone. Up to 1000 entries may be stored in each phonebook. (→P. 514)



1 Display the “Phone” screen. (→P. 493)

2 Select “Contacts” on the “Phone” screen.

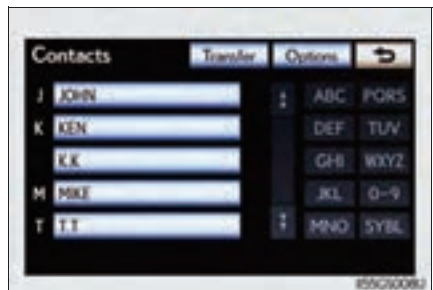
3 Choose the desired data to call from the list.





- 4 Choose the number and then select  or press  on the steering wheel.

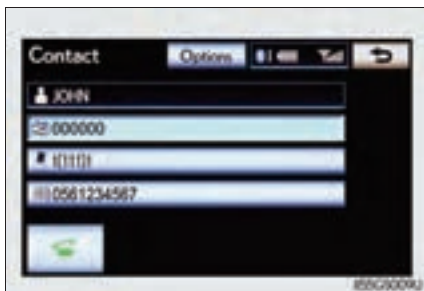

### ■ When the phonebook is empty

If your cellular phone is neither PBAP nor OPP compatible, the phonebook cannot be transferred.

- 1 Display the "Phone" screen. (→P. 493)
  - 2 Select "Contacts" on the "Phone" screen.
- PBAP compatible models

- 3 Select "Yes".



- PBAP incompatible but OPP compatible models

- 3 Select "Transfer".



- 4 Transfer the phonebook data to the system using the Bluetooth® phone.

This screen appears while transferring. To cancel this function, select “Cancel”.

Depending on the type of cellular phone, OBEX authentication may be required when transferring phonebook data. Enter “1234” into the Bluetooth® phone.

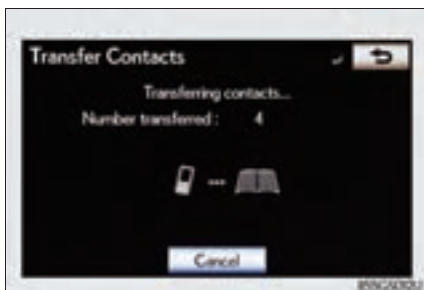

- 5 When the data transfer from a PBAP incompatible but OPP compatible model is complete, “Done” will appear on the screen. Select “Done”.

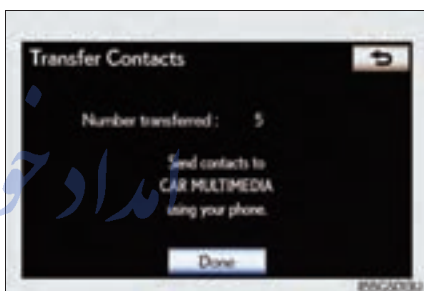

### ■ Calling using speed dial

You can make a call using numbers registered from the phonebook. (→P. 514)

- 1 Display the “Phone” screen. (→P. 493)
- 2 Select “Speed Dials” on the “Phone” screen.
- 3 Select the desired tab and choose the desired number to make a call.

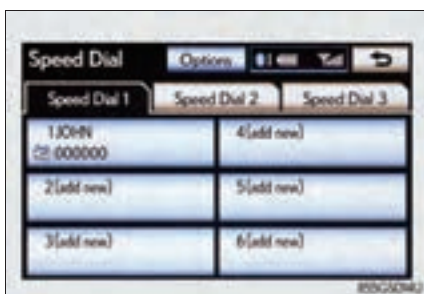

## ■ Dialing from history

You can call using the call history which has the 4 functions below.

“All”: All the numbers below which were memorized

“Missed”: Calls which you missed

“Incoming”: Calls which you received

“Outgoing”: Numbers which you called

You can call using the 25 most recently called numbers shown by “All” tab while driving.

- 1 Display the “Phone” screen. (→P. 493)
- 2 Select “Call History” on the “Phone” screen.
- 3 Select the desired tab and choose the desired data from the list.

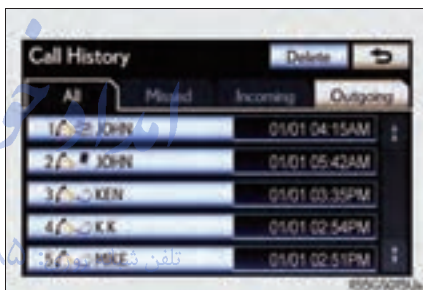

- 4 Select  or press  on the steering wheel.

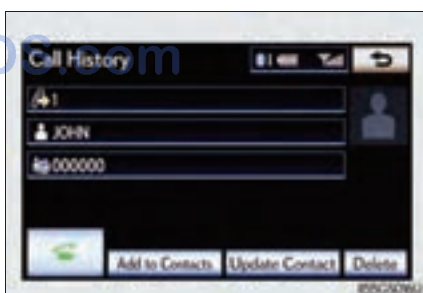

### ■ Calling using voice recognition

You can call by giving a voice command. (→P. 334)

Press .

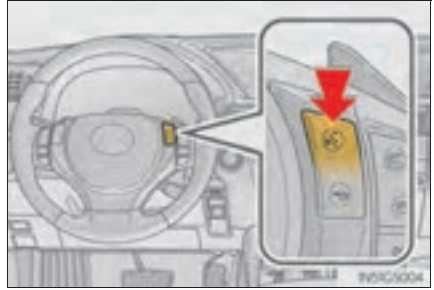

The “Call <name> <type>” and “Dial <number>” operating procedures are explained here. Other operating procedures are also similar.

### ● Calling by name

You can call by giving a name registered in the phonebook. (→P. 514)

**1** Press .

**2** Following the system guidance, wait for the beep and then after saying “Call” say the desired name, or the name and type of phone.

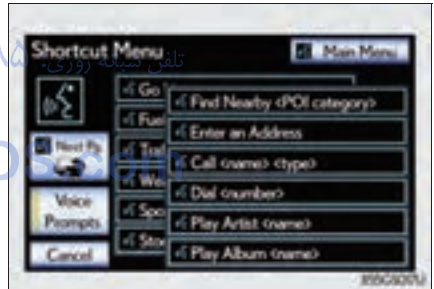

**3** Following the system guidance, wait for the beep and then say “Dial”.

(You can also call by pressing  on the steering wheel.)

### ● Calling by dial number

You can call by giving a phone number

1 Press .

2 Following the system guidance, wait for the beep and then after saying “Dial” say the phone number.

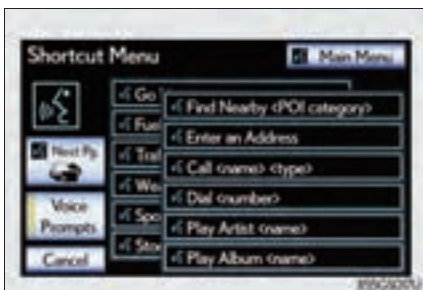

3 Following the system guidance, wait for the beep and then say “Dial”.  
(You can also call by pressing  on the steering wheel.)

### ■ Calling using SMS/MMS message

You can call using the SMS (Short Message Service)/MMS (Multimedia Messaging Service) message sender's phone number.

1 Display the “Phone” screen. (→P.493)

2 Select “Messages”.

When “Message Transfer” is set to “Off”, a confirmation screen will be displayed. Select “Yes”.

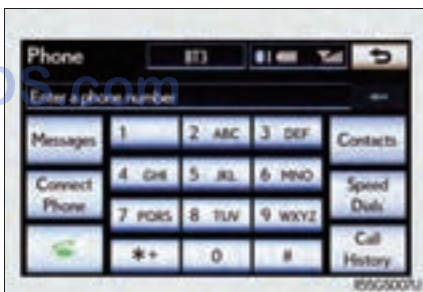

3 Select the “SMS/MMS” tab and then select the desired received message from the list.

The tab display may vary depending on the type of cellular phone.

4 Select  or press  on the steering wheel.

### ■ Calling using POI (vehicles with the navigation system)

You can make a call using a Point Of Interest.

### ■ Call history list

- If you make a call to or receive a call from a number registered in the phone book, the name is displayed in the call history.
- If you make multiple calls to the same number, only the last call made is displayed in the call history.
- Number-withheld calls are also memorized in the system.

### ■ When driving

The functions “Dialing”, “Dialing from the phonebook”, and “Dialing from history” (except for call using the 25 most recently called numbers shown by “All” tab) are unavailable.

### ■ When calling by registered name in the phonebook

- When “Call <name> <type>” on the “Shortcut Menu” screen is dimmed, the phonebook’s voice command recognition cannot be used. Check the Bluetooth® connection and if the contacts have been transferred to the system.
- Short or abbreviated names in the phonebook may not be recognized. Change names in the phonebook to full names.
- Sometimes a voice recognition result confirmation screen will be displayed. After confirming the result, say “Yes” or “No”.
- When the system recognizes multiple names from the phonebook, a name candidate list will be displayed on the screen. If the desired name is not displayed on the top of the screen, say the number of the name from the candidate list (number 1 and number 2) to select a name from the candidate list.
- When a contact has multiple phone numbers registered in the phonebook, a candidate list will be displayed. If the desired phone number is not displayed on the top of the screen, say the number of the desired phone number from the candidate list (number 1 and number 2) to select a phone number from the candidate list.

### ■ When calling by phone number

- Say the phone number one digit at a time. For example, if the phone number is 2345678, say “two three four five six seven eight”.
- The system can recognize the following types of phone numbers:
  - 3 digit numbers (911, 411, 611)
  - 7 digit numbers (Local phone numbers)
  - 10 digit numbers (Area code + Local phone number)
  - 11 digit phone numbers (1 + Area code + Local phone number)
- As the system cannot recognize additional numbers, say the complete number without stopping.
- When the system recognizes multiple phone numbers, a phone number candidate list will be displayed on the screen. If the desired phone number is not displayed on the top of the screen, say the number of the desired phone number from the candidate list (number 1 and number 2) to select a phone number from the candidate list

### ■ International calls





To dial a phone number that is not a 3, 7, 10 or 11 digit number, for example an international number, use “International Call”.

- 1 Press  on the steering wheel to display the “Shortcut Menu” screen and saying “Main menu” or select “Main Menu”.
- 2 Say “Use a phone”.
- 3 Say “International call”.



Up to 24 digits can be recognized when using the international call function. The number can also be divided into multiple groups and recognized.

You may not be able to make international calls, depending on the cellular phone in use.

### ■ Calling by using the latest call history item

- 1 Press  on the steering wheel to display the “Phone” screen.
- 2 Press  on the steering wheel to display the “Call History” screen.
- 3 Press  on the steering wheel to select the most recent number in the history.
- 4 Select  or press  on the steering wheel.

### ■ To cancel voice recognition



- Press and hold .
- Press  on the steering wheel.
- Select "Cancel".

### ■ When using voice recognition

Use correct commands and speak clearly, otherwise the system may not correctly recognize the command. Wind or other noises may also cause the system not to recognize the desired command.

## Receiving a call

When a call is received, the following screen is displayed together with a sound.

Select  or press  on the steering wheel.



### ■ To refuse a call

Select  or press  on the steering wheel.

### ■ To adjust the incoming call volume

Select "-" or "+", turn the "PWR/VOL" knob, or use the volume switch on the steering wheel.

### ■ International calls

Received international calls may not be displayed correctly depending on the cellular phone in use.



## Speaking on the phone

The following screen is displayed when speaking on the phone.



### ■ To adjust the incoming call volume

Select “-” or “+”, turn the “PWR/VOL” knob, or use the volume switch on the steering wheel.

### ■ To prevent the other party from hearing your voice

Select “Mute”.

تلفن شبانه روزی: ۰۲۱-۸۸۶۲۰۸۵

FarmaSOS.com

### ■ Inputting tones

When using phone services such as an answering service or a bank, you can store phone numbers and code numbers in the phonebook.

1 Select “0-9” on the “Call” screen.

2 Input the number.

If repeated tone symbols\* are stored in the phonebook, “Send” and “Clear” are displayed on the right side of the screen.

\*: Repeated tone symbols are symbols or numbers displayed as p or w, that come after the phone number.

(e.g. 056133w0123p#1\*)

3 Confirm the number displayed on the screen, and select “Send”.

If you select “Clear”, this function will end.

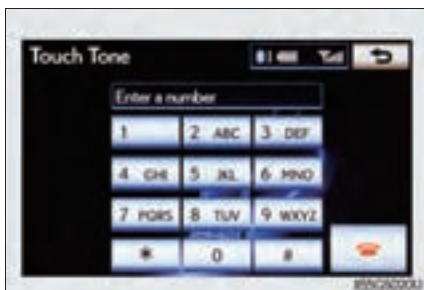

### ■ To transfer a call





Select “Handset Mode” to change from hands-free call to cellular phone call. Select “Handsfree Mode” to change from cellular phone call to hands-free call.

### ■ To hang up

Select  or press  on the steering wheel.

### ■ Call waiting

When a connected call is interrupted by the third party, the incoming call message will be displayed.

- To talk with the other party: Select  or press  on the steering wheel.
- To refuse the call: Select  or press  on the steering wheel.

Everytime you select  or press  on the steering wheel after a call is interrupted, you will be switched to the other party.

If your cellular phone is not accepted in HFP Ver. 1.5, this function cannot be used.

### ■ Transferring calls

- It is not possible to transfer from hands-free to a cellular phone while driving.
- If you transfer from a cellular phone to hands-free, the hands-free screen will be displayed, and you can operate the system using the screen.
- Transfer method and operation may vary according to the cellular phone used.
- For operation of the cellular phone in use, see the phone's manual.

### ■ Repeated tone symbols

When the “p” pause tone is used, after waiting 2 seconds the tone data up until the next pause tone will be automatically sent. When the “w” pause tone is used, the tone data up until the next pause tone will be automatically sent after user operation.

### ■ While driving

Key input is unavailable.

### ■ Voice recognition during a call

“Send Tones” can be operated by voice recognition. (→P. 334)

### ■ Interrupt call operation

Interrupt call operation may differ from depending on your phone company and the cellular phone.

## Using a Bluetooth® phone message

Received messages can be forwarded from the connected Bluetooth® phone, enabling checking and replying (Quick reply).

### ■ Checking a message

- 1 Display the “Phone” screen. (→P. 493)
- 2 Select “Messages” on the “Phone” screen.

When “Message Transfer” is set to “Off”, a confirmation screen will be displayed. Select “Yes”.

- 3 Select the desired message to check.

The text of the message is not displayed while driving.

Selecting “Previous” or “Next” displays the previous or next message.

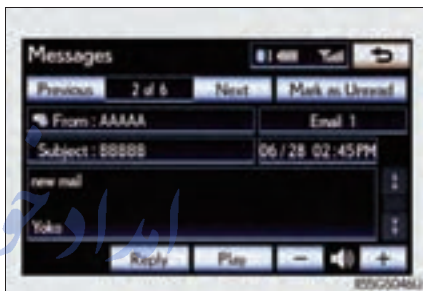

- 4 Select “Play” to start reading out of the message. Select “Stop” to stop the function.

### ■ To adjust the message reading out volume

Select “-” or “+”, turn the “PWR/VOL” knob, or use the volume switch on the steering wheel.

### ■ Replying a message (Quick reply)

- 1 Select “Reply” on the desired message screen.

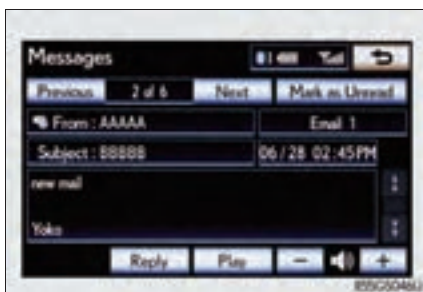

- 2 Select the desired message.  
Select "Send".

While the message is being sent, a sending message screen is displayed.

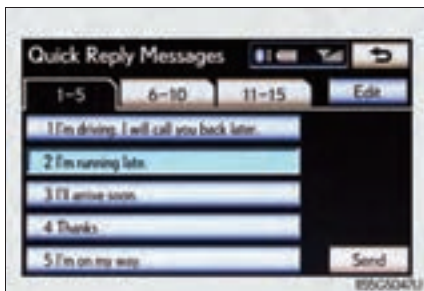

### ■ To check the message

- Messages are displayed in the appropriate connected Bluetooth® phone's registered mail address folder. Select the tab of the desired folder to be displayed.
- Only received messages on the connected Bluetooth® phone can be displayed.
- When the received message is an e-mail and "Update Message Read Status on Phone" is set to "On", "Mark as Unread" or "Mark as Read" can be selected. Select "Mark as Unread" to mark mails that have been read on the Bluetooth® phone as unread. Conversely, select "Mark as Read" to mark mails that have not been read on the Bluetooth® phone as read. (→P. 528)

### ■ Calling using SMS/MMS message

You can call using the SMS (Short Message Service)/MMS (Multimedia Messaging Service) message sender's phone number. (→P. 503) تلفن شماره

### ■ If the message delivery failed

If message delivery has failed, a notification will be displayed on the screen.

Select "Retry" to attempt to send the message again or select "Cancel" to cancel.

### ■ Editing a quick reply message

You can edit the "Quick Reply Messages". (→P. 530)

### ■ New message notification

If "New Message Pop-up" and "New Message Voice Notification" are set to "On", a notification appears on the screen and a voice notification will be heard when a new message arrives, select "Read" to check the message, also to check the message later, select "Ignore". When "Automatic Message Readout" is set to "On", the message will be automatically read out. (→P. 528)

## Setting the hands-free system (for cellular phone)

You can set the hands-free system to your desired settings.

- ① Phone sound settings
- ② Phonebook settings
- ③ Message settings
- ④ Phone display settings

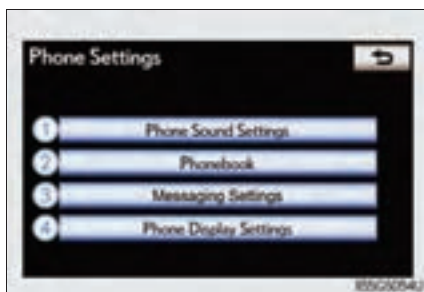

To display the screen shown above, press the “MENU” button on the Remote Touch, then select “Setup”, and select “Phone” on the “Setup” screen.

امداد خودرو فارما

تلفن شبانه روزی: ۰۲۱-۸۸۶۲۰۸۵

FarmaSOS.com

## Phone sound settings

### ■ Setting the volume

- 1 Display the “Phone Settings” screen. (→P. 512)
- 2 Select “Phone Sound Settings” on the “Phone Settings” screen.
- 3 Choose the volume setting switch.

“Call Volume”: changes the speaker volume

“Ring Tone Volume”: changes the ring tone volume

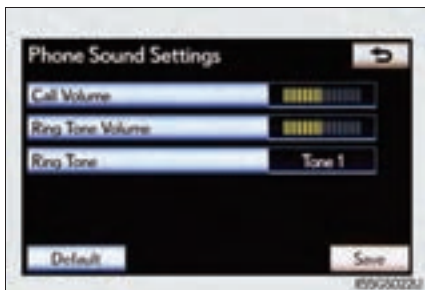

- 4 Select “-” or “+” to lower or raise the volume, and then select “OK”.

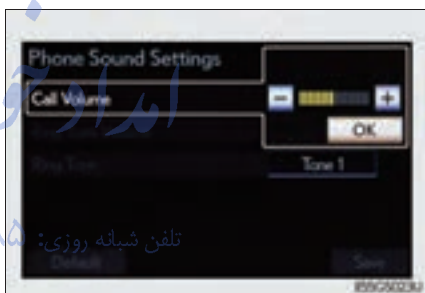

- 5 When you complete all settings, select “Save”.

### ■ Setting the ring tone

- 1 Display the “Phone Settings” screen. (→P. 512)
- 2 Select “Phone Sound Settings” on the “Phone Settings” screen.
- 3 Select “Ring Tone” on the “Phone Sound Settings” screen.
- 4 Select the screen button corresponding to the desired ring tone.

Ring tones can be heard by selecting the screen buttons, and then “OK”.

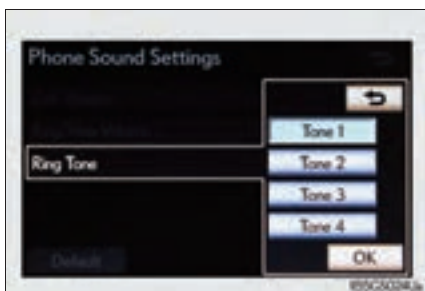

- 5 When you complete setting, select “Save”.

### ■ Adaptive volume control

When traveling at 50 mph (80 km/h) or more, the system automatically raises the volume.

### ■ To return to the default phone sound settings

Select “Default”, and then “Yes”.

## Phonebook settings

The phonebook manages a maximum of 5 phonebooks in total. The data for 1000 contacts (up to 3 numbers per contact) can be registered in each phonebook.

- ① Setting the phonebook
- ② Setting the speed dials
- ③ Deleting the call history

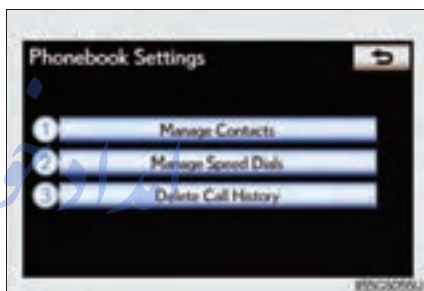

To display the screen above, follow the steps below.

- 1 Press the “MENU” button on the Remote Touch, then select “Setup”, and select “Phone” on the “Setup” screen.
- 2 Select “Phonebook” on the “Phone Settings” screen.

### ■ Setting the phonebook

#### ● Transferring a phone number

You can transfer the phone numbers in your Bluetooth® phone to the system. Operation methods differ between PBAP compatible and PBAP incompatible but OPP compatible Bluetooth® phones. If your cellular phone is neither PBAP nor OPP compatible, the phonebook cannot be transferred.



► For PBAP compatible Bluetooth® phones

- 1 Display the “Phonebook Settings” screen. (→P. 514)
- 2 Select “Manage Contacts” on the “Phonebook Settings” screen.
- 3 Select “Transfer Contacts”.

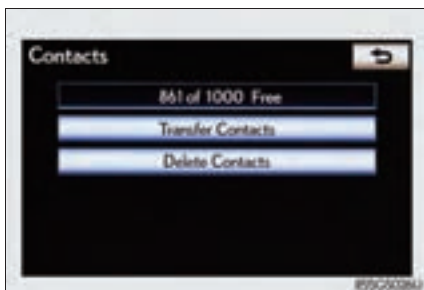

- 4 Select “Update Contacts”.

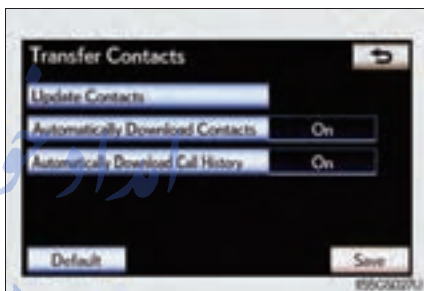

- 5 Transfer the phonebook data to the system using the Bluetooth® phone.

This operation may be unnecessary depending on the cellular phone model.

Depending on the type of cellular phone, OBEX authentication may be required when transferring phonebook data. Enter “1234” into the Bluetooth® phone.

If you wish to cancel the transfer before it finishes, select “Cancel”.

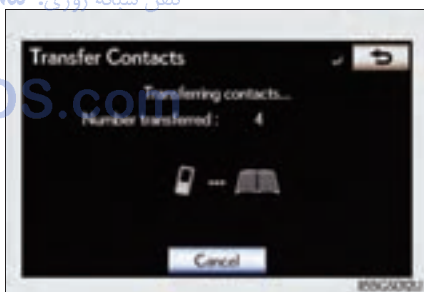

- ▶ PBAP compatible models automatic data transfer setting

- 1 Display the "Phonebook Settings" screen. (→P. 514)
- 2 Select "Manage Contacts" on the "Phonebook Settings" screen.
- 3 Select "Transfer Contacts" on the "Contacts" screen.
- 4 Select the item to be set.

"Automatically Download Contacts": Transfer the phonebook from a connected cellular phone.

"Automatically Download Call History": transfer the call history from a connected cellular phone.

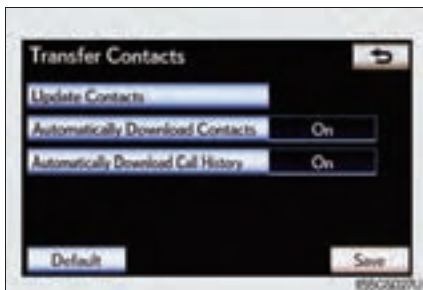

- 5 Select "On", and then "Save".



- ▶ For PBAP incompatible but OPP compatible Bluetooth® phones

- 1 Display the "Phonebook Settings" screen. (→P. 514)
- 2 Select "Manage Contacts" on the "Phonebook Settings" screen.
- 3 Select "Transfer Contacts".

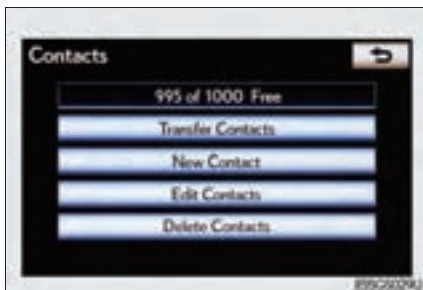

- 4 Select "Replace Contacts" or "Add Contacts".

In the case that the phonebook contains phonebook data, this screen is displayed.

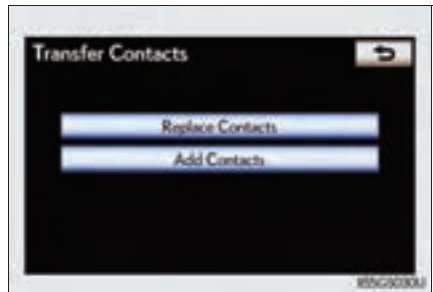

- 5 Transfer the phonebook data to the system using the Bluetooth® phone.

Depending on the type of cellular phone, OBEX authentication may be required when transferring phonebook data. Enter "1234" into the Bluetooth® phone.

If you wish to cancel the transfer before it finishes, select "Cancel".

If "Add Contacts" is selected and there is an interruption during the transfer of data, the phonebook data transferred until then will be stored in the system. Please note, this is not the case when "Cancel" is selected.

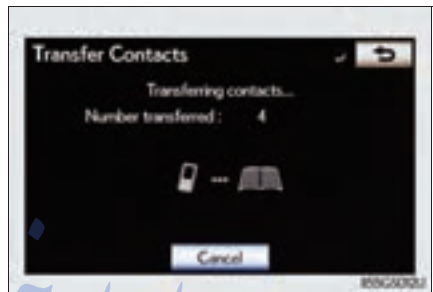

- 6 When the transfer is complete, "Done" will appear on the screen. Select "Done".

- Registering the phonebook data

You can register the phonebook data. Up to 3 numbers per person can be registered. New phonebook data cannot be added for PBAP compatible Bluetooth<sup>®</sup> phones.

- 1 Display the “Phonebook Settings” screen. (→P. 514)
- 2 Select “Manage Contacts” on the “Phonebook Settings” screen.
- 3 Select “New Contact” on the “Contacts” screen.
- 4 Input the name, and select “OK”.



- 5 Input the phone number, and select “OK”.

If you want to use the tone signal after the phone number, input the tone signal too.

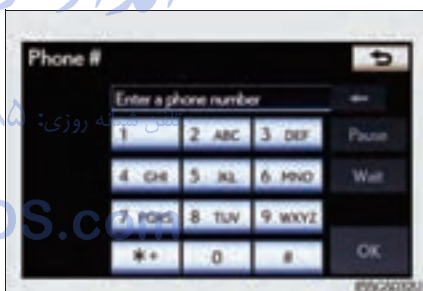

- 6 Select the desired phone type.

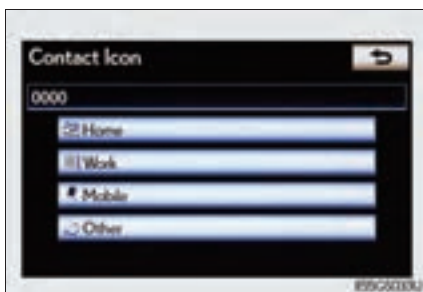

- 7 When two or less numbers in total are registered to this contact, this screen is displayed. When you want to add a number to this contact, select “Yes”.

- Editing the phonebook data

You can register the phone number separately. Phonebooks cannot be edited for PBAP compatible Bluetooth<sup>®</sup> phones.

- 1 Display the “Phonebook Settings” screen. (→P. 514)
- 2 Select “Manage Contacts” on the “Phonebook Settings” screen.
- 3 Select “Edit Contacts” on the “Contacts” screen.
- 4 Choose the data to edit.

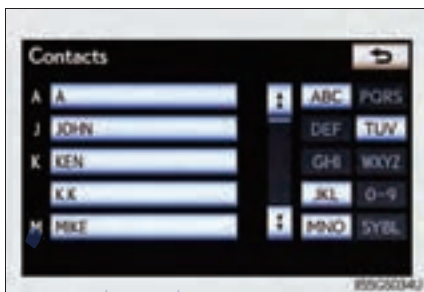

- 5 Select the desired name or number.

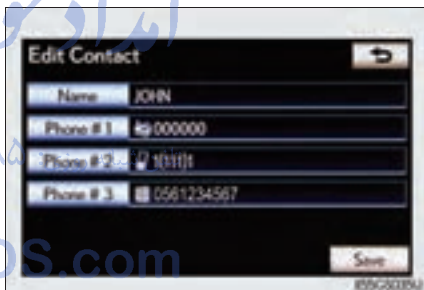

- 6 Edit the name or number. After editing, select “Save”.

● Deleting the phonebook data

- 1 Display the "Phonebook Settings" screen. (→P. 514)
- 2 Select "Manage Contacts" on the "Phonebook Settings" screen.
- 3 Select "Delete Contacts" on the "Contacts" screen.
- 4 Choose the data to delete.

You can select multiple data and delete them at the same time.

To delete all data, select "Select All".

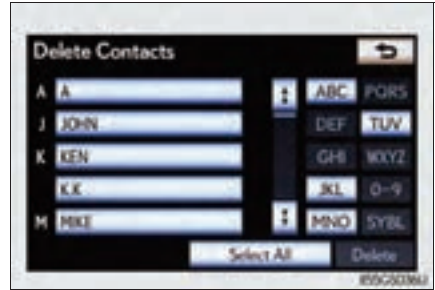

- 5 Select "Delete". A confirmation message will be displayed. If everything is correct, select "Yes".

امداد خودرو فارما

تلفن شبانه روزی: ۰۲۱-۸۸۶۲۰۸۵

FarmaSOS.com

### ■ Phonebook data

Phonebook data is managed for every registered phone. When another phone is connecting, you cannot read the registered data.

When selling or disposing of the vehicle, delete all your data on the system.

For PBAP compatible phones, delete the phonebook data after setting "Automatically Download Contacts" to "Off". (→P. 516)

### ■ Setting the phonebook in a different way (To display the "Contacts" screen)

- 1 Display the "Phone" screen. (→P. 493)
- 2 Select "Contacts" on the "Phone" screen.
- 3 Select "Options" on the "Contacts" screen.
- 4 Select "Manage Contacts" on the "Contacts" screen.

### ■ When another Bluetooth® device is connected during transferring a phonebook

- For PBAP compatible Bluetooth® phones  
If another Bluetooth® device is connected when transferring phonebook data, depending on the phone, the connected Bluetooth® device may need to be disconnected.
- For PBAP incompatible but OPP compatible Bluetooth® phones  
When another Bluetooth® device is connected, a confirmation message will be displayed. If you want to disconnect it, select "Yes".

تلفن شبانه روزی: ۰۲۱-۸۸۶۲۰۸۵

FarmaSOS.com

### ■ Transferring the phone number data in a different way

- 1 Display the "Phone" screen. (→P. 493)
- 2 Select "Contacts" on the "Phone" screen.
- 3 Select "Transfer" on the "Contacts" screen.
- 4 The "Transfer Contacts" screen is displayed. The following operations are performed in the same manner as when they are performed from the "Setup" screen.

### ■ Editing the phonebook data in a different way

- From "Contact" screen

- 1 Display the "Phone" screen. (→P. 493)
- 2 Select "Contacts" on the "Phone" screen.
- 3 Choose the desired data from the list.
- 4 Select "Options" on the "Contact" screen.
- 5 Select "Edit" on the "Contact" screen.
- 6 Follow the steps "Editing the phonebook data" from step 5. (→P. 519)

- From "Call History" screen

- 1 Display the "Phone" screen. (→P. 493)
- 2 Select "Call History" on the "Phone" screen.
- 3 Choose the desired data from the list.
- 4 Select "Add to Contacts" or "Update Contact" on the "Call History" screen.
- 5 If you select "Add to Contacts", follow the steps "Editing the phonebook data" from step 5. (→P. 519)  
If you select "Update Contact", follow the steps "Editing the phonebook data" from step 4. (→P. 519)

### ■ Deleting the phonebook data in a different way (PBAP incompatible but OPP compatible models)

- 1 Display the "Phone" screen. (→P. 493)
- 2 Select "Contacts" on the "Phone" screen.
- 3 Choose the desired data from the list.
- 4 Select "Options" on the "Contact" screen.
- 5 Select "Delete" on the "Contact" screen.
- 6 A confirmation message will be displayed. If everything is correct, select "Yes".

### ■ When a Bluetooth® phone is deleted.

The phonebook data will be deleted at the same time.



## Setting the speed dials

### ■ Registering the speed dial

You can register the desired phone number from the phonebook. Up to 18 numbers per phone can be registered.

- 1 Display the “Phonebook Settings” screen. (→P. 514)
- 2 Select “Manage Speed Dials” on the “Phonebook Settings” screen.
- 3 Select “New”.

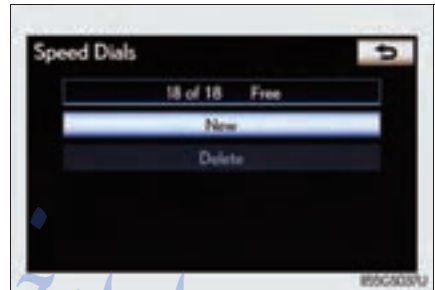

- 4 Choose the data to register.



- 5 Select the desired phone number.

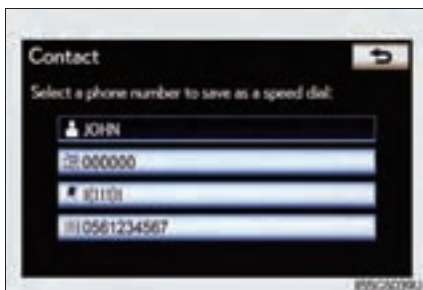

- 6 Select the switch you want to register the number in.

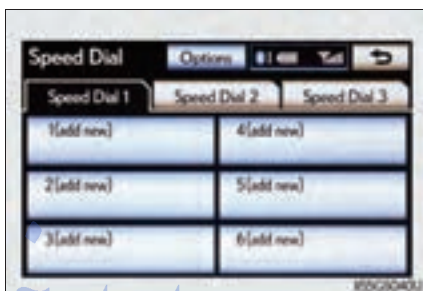

- 7 If you select a switch you registered before, a confirmation message will be displayed. If you want to replace it, select "Yes".

#### ■ Deleting the speed dial

- 1 Display the "Phonebook Settings" screen. (→P. 514)
- 2 Select "Manage Speed Dials" on the "Phonebook Settings" screen.
- 3 Select "Delete" on the "Speed Dials" screen.
- 4 Choose the data to delete.

You can select multiple data and delete them at the same time.

To delete all data, select "Select All".

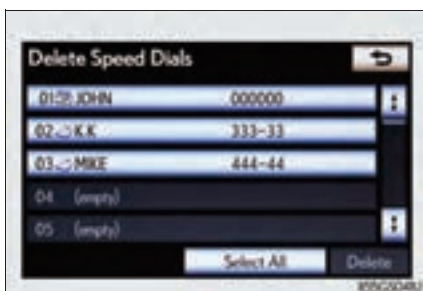

- 5 Select "Delete". A confirmation message will be displayed. If everything is correct, select "Yes".

### ■ Setting the speed dials in a different way

- To display the “Speed Dials” screen

- 1 Display the “Phone” screen. (→P. 493)
- 2 Select “Speed Dials” on the “Phone” screen.
- 3 Select “Options” on the “Speed Dial” screen.

- To display the “Contacts” screen

- 1 Display the “Phone” screen. (→P. 493)
- 2 Select “Contacts” on the “Phone” screen.
- 3 Select “Options” on the “Contacts” screen.
- 4 Select “Manage Speed Dials” on the “Contacts” screen.

### ■ Registering the speed dial in a different way

- From “Speed Dial” screen

- 1 Display the “Phone” screen. (→P. 493)
- 2 Select “Speed Dials” on the “Phone” screen.
- 3 Select “(add new)” on the “Speed Dial” screen.
- 4 Select “Yes” to set new speed dial.
- 5 Choose the desired data from the list.
- 6 Select the desired phone number.
- 7 Follow the steps “Registering the speed dial” from step 6. (→P. 523)

- From “Contact” screen

- 1 Display the “Phone” screen. (→P. 493)
- 2 Select “Contacts” on the “Phone” screen.
- 3 Choose the desired data from the list.
- 4 Select “Options” on the “Contact” screen.
- 5 Select “Set Speed Dial” on the “Contact” screen.
- 6 Select the desired phone number.
- 7 Follow the steps “Registering the speed dial” from step 6. (→P. 523)

## Deleting call history

The call history can be deleted. For PBAP compatible phones, delete the call history after setting “Automatically Download Call History” to “Off”. (→P. 516)

- 1 Display the “Phonebook Settings” screen. (→P. 514)
- 2 Select “Delete Call History” on the “Phonebook Settings” screen.
- 3 Choose the desired history to delete.

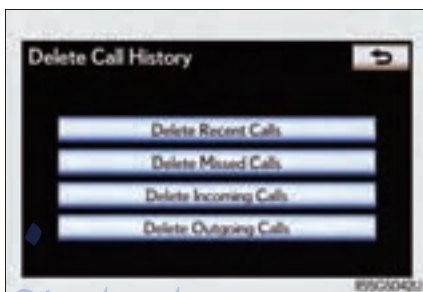

- 4 Choose the data to delete.  
You can select multiple data and delete them at the same time.  
To delete all data, select “Select All”.

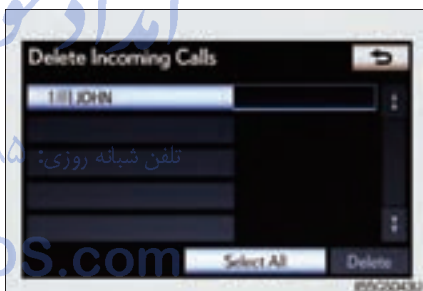

- 5 Select “Delete”. A confirmation message will be displayed. If everything is correct, select “Yes”.

**■ Deleting call history in a different way**

- 1 Display the "Phone" screen. (→P. 493)
- 2 Select "Call History" on the "Phone" screen.
- 3 Select "Delete" on the "Call History" screen.
- 4 Follow the steps "Deleting call history" from step 4. (→P. 526)

**■ Deleting after call history has been displayed**

- 1 Display the "Phone" screen. (→P. 493)
- 2 Select "Call History" on the "Phone" screen.
- 3 Select the desired history to delete.
- 4 Select "Delete". A confirmation message will be displayed. If everything is correct, select "Yes".

امداد خودرو فارما

تلفن شبانه روزی: ۰۲۱-۸۸۶۲۰۸۵

FarmaSOS.com

## Message settings

You can change the message settings.

▶ Page 1

▶ Page 2

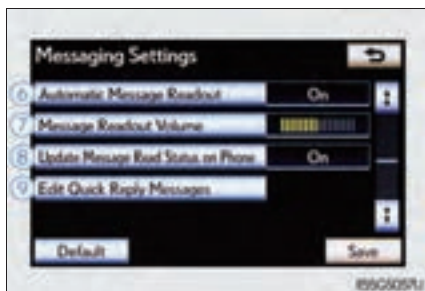
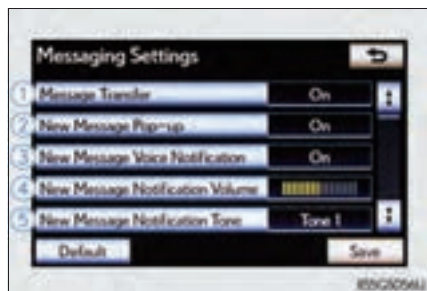

- ① Message forwarding from cellular phone on/off
- ② New message notification display on/off
- ③ New message voice notification on/off
- ④ Changing new message notification volume
- ⑤ Changing new message voice notification tone
- ⑥ Automatic message read out function on/off
- ⑦ Changing a message read out volume
- ⑧ Cellular phone's message read and unread status update function on/off
- ⑨ Editing "Edit Quick Reply Messages"

To display the screen above, follow the steps below.

- 1** Press the "MENU" button on the Remote Touch, then select "Setup", and select "Phone" on the "Setup" screen.
- 2** Select "Messaging Settings" on the "Phone Settings" screen.

### ■ Changing the new message notification volume

- 1 Display the “Messaging Settings” screen. (→P. 528)
- 2 Select “New Message Notification Volume” on the “Messaging Settings” screen.
- 3 Select “-” or “+” to lower or raise the volume, and then “OK”.

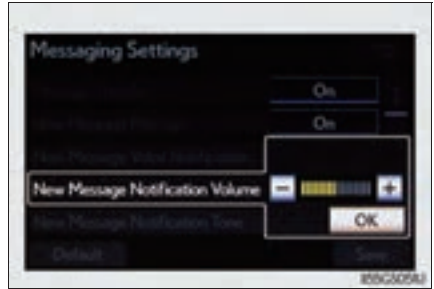

- 4 When you complete setting, select “Save”.

### ■ Changing the new message notification tone

- 1 Display the “Messaging Settings” screen. (→P. 528)
- 2 Select “New Message Notification Tone” on the “Messaging Settings” screen.
- 3 Select the desired new message notification tone.

New message notification tones can be heard by selecting the screen buttons, and then “OK”.

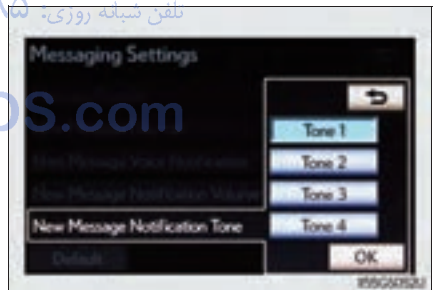

- 4 When you complete setting, select “Save”.

### ■ Changing the message read out volume

- 1 Display the “Messaging Settings” screen. (→P. 528)
- 2 Select “Message Readout Volume” on the “Messaging Settings” screen.
- 3 Select “-” or “+” to lower or raise the volume, and then “OK”.

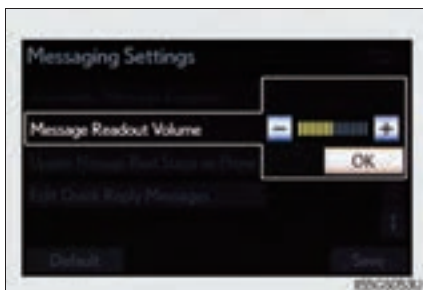

- 4 When you complete setting, select “Save”.

### ■ Editing the quick reply messages

Quick reply messages can be edited. 15 messages have already been stored.

- 1 Display the “Messaging Settings” screen. (→P. 528)
- 2 Select “Edit Quick Reply Messages” on the “Messaging Settings” screen.
- 3 Select the screen button corresponding to the desired message.



- 4 Edit the message. After editing, select “OK” and then “Save”.



**■ To display the “Message settings” screen in a different way**

- 1 Display the “Phone” screen. (→P. 493)
- 2 Select “Messages” on the “Phone” screen.
- 3 Select “Options” on the “Messages” screen.

**■ Editing the quick reply messages in a different way**

- 1 Display the desired message on “Message” screen. (→P. 510)
- 2 Select “Reply” on the desired message screen.
- 3 Select “Edit” on the “Quick Reply Messages”.
- 4 Select the screen button corresponding to the desired message.
- 5 When you complete editing, select “OK” and then  on the “Edit Quick Reply Message” screen.

**■ Adaptive volume control**

When traveling at 50 mph (80 km/h) or more, the system automatically raises the volume.

**■ To return to the default message settings**

Select “Default”, and then “Yes”.

تلفن شبانه روزی: ۰۲۱-۸۸۶۲۰۸۵

FarmaSOS.com

## Phone display settings

Depending on the phone, this function may not be available even if the phone is PBAP compatible.

- ▶ Vehicles without a navigation system
- ▶ Vehicles with a navigation system

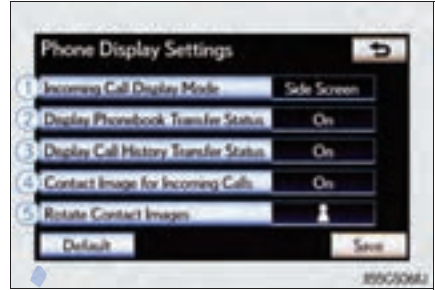
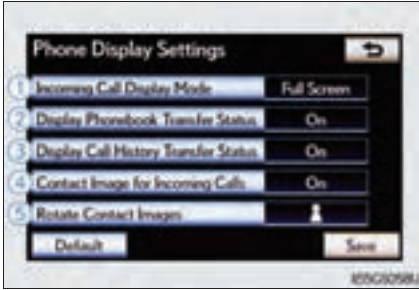

- ① Changing the incoming call display mode
- ② Changing the display phonebook transfer status on/off\*
- ③ Changing the display call history transfer status on/off\*
- ④ Changing the contact image during incoming call on/off\*
- ⑤ Changing the rotate contact image\*

\*: For PBAP compatible models

To display the screen above, follow the steps below.

- 1** Press the “MENU” button on the Remote Touch, then select “Setup”, and select “Phone” on the “Setup” screen.
- 2** Select “Phone Display Settings” on the “Phone Settings” screen.

## ■ Changing the incoming call display mode

You can select the method of the incoming call display.

- 1 Display the “Phone Display Settings” screen. (→P. 532)
  - 2 Select “Incoming Call Display Mode” on the “Phone Display Settings” screen.
- ▶ Vehicles without a navigation system
- 3 Select “Full Screen” or “Drop Down”, and select “Save”.

“Full Screen”: The hands-free screen is displayed when a call is received, and you can operate the system from that screen.

“Drop Down”: A message is displayed at the top of the screen, and you can only operate the system with the steering switches.

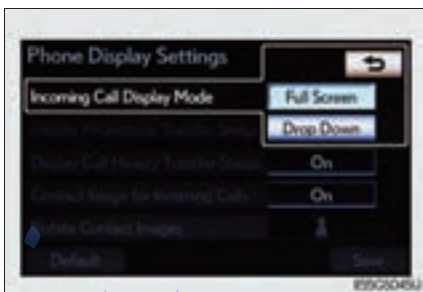

- ▶ Vehicles with a navigation system

- 3 Select “Main Screen” or “Side Screen”, and select “Save”.

“Main Screen”: The hands-free screen is displayed when a call is received, and you can operate the system from that screen.

“Side Screen”: A message is displayed at the side screen, and you can only operate the system with the steering switches.

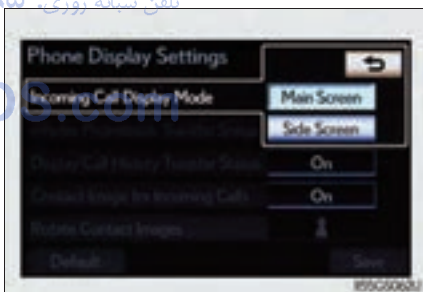

### ■ Changing the rotating contact images

For PBAP compatible models, when “Contact Image for Incoming Calls” is set to “On”, images stored together with phone numbers in the cellular phone’s phonebook will be transferred and displayed during the incoming call. The orientation of the image can be set.

- 1 Display the “Phone Display Settings” screen. (→P. 532)
- 2 Select “Rotate Contact Images” on the “Phone Display Settings” screen.
- 3 Choose the desired orientation of the image to be displayed, and then “Save”.

---

### ■ To return to the default detailed phone settings

Select “Default”, and then “Yes”.

امداد خودرو فارما

تلفن شبانه روزی: ۰۲۱-۸۸۶۲۰۸۵

FarmaSOS.com

## Setting the Bluetooth®

You can confirm and change the Bluetooth® settings.

- ① Registered Devices
- ② Connect Phone
- ③ Connect Portable Player
- ④ Detailed Bluetooth® settings

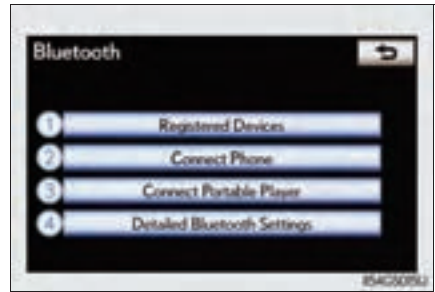

To display the screen shown above, press the “MENU” button on the Remote Touch, then select “Setup”, select “Bluetooth\*” on the “Setup” screen.

\*: Bluetooth is a registered trademark of Bluetooth SIG, Inc.

تلفن شبانه روزی: ۰۲۱-۸۸۶۲۰۸۵

FarmaSOS.com

## Registered devices

### ■ Registering a Bluetooth® devices

Bluetooth® devices compatible with phones (HFP) and portable players (AVP) can be registered simultaneously. Phones (HFP) and portable players (AVP) (maximum of 5) can be registered.

- 1 Display the “Bluetooth\*” screen. (→P. 535)
- 2 Select “Registered Devices” on the “Bluetooth\*” screen.
- 3 Select “Add New” to register a Bluetooth® device to the system.

When 5 Bluetooth® devices have already been registered, a registered device needs to be deleted. Select “Yes” to delete one or more. Select the device to be deleted, then select “Remove”, and then “Yes”.

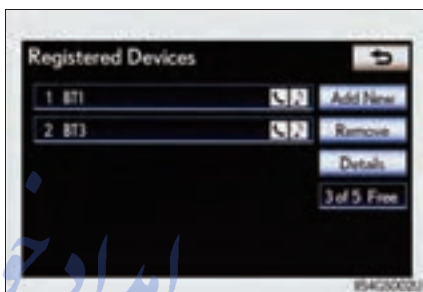

\*: Bluetooth is a registered trademark of Bluetooth SIG, Inc.

- 4 Input the passcode displayed on the screen into the Bluetooth® device.

A passcode is not required for SSP (Secure Simple Pairing) compatible Bluetooth® devices. Depending on the type of Bluetooth® phone being connected, a message confirming registration may be displayed on the Bluetooth® phone's screen. Respond and operate the Bluetooth® phone according to the confirmation message.

For the operation of the Bluetooth® device, see the manual that comes with it.

If you want to cancel it, select "Cancel".

If a completion message is displayed, registration is complete.

If an error message is displayed, follow the guidance on the screen to try again.

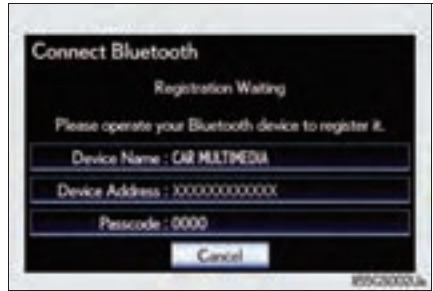

### ■ Removing a Bluetooth® device

- 1 Display the “Bluetooth\*” screen. (→P. 535)
- 2 Select “Registered Devices” on the “Bluetooth\*” screen.
- 3 Select “Remove” on the “Registered Devices” screen.
- 4 Choose the desired device.

You can select multiple device and delete them at the same time.

To remove all devices, select “Select All”.

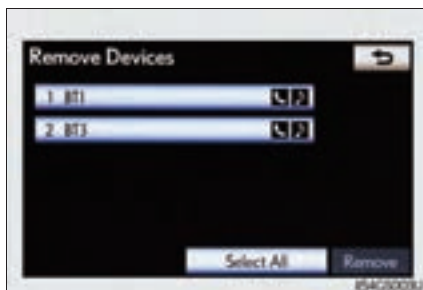

- 5 Select “Remove”. A confirmation message will be displayed. If everything is correct, select “Yes”.

\*: Bluetooth is a registered trademark of Bluetooth SIG, Inc.

### ■ Editing a Bluetooth® device

You can see the information of the Bluetooth® device on the system or edit.

#### ● Changing a device name

- 1 Display the “Bluetooth\*” screen. (→P. 535)
- 2 Select “Registered Devices” on the “Bluetooth\*” screen.
- 3 Select “Details”.



\*: Bluetooth is a registered trademark of Bluetooth SIG, Inc.



- 4 Select the device to be edited.

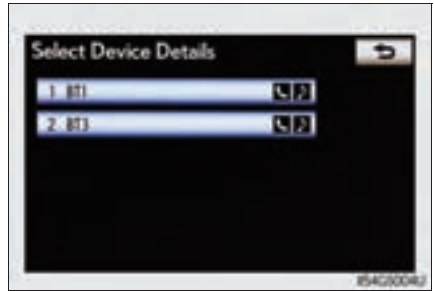

- 5 Select "Device Name".

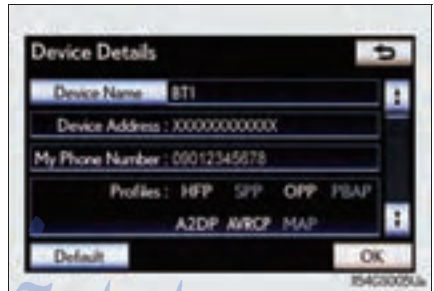

- 6 Input the device name, and select "OK".

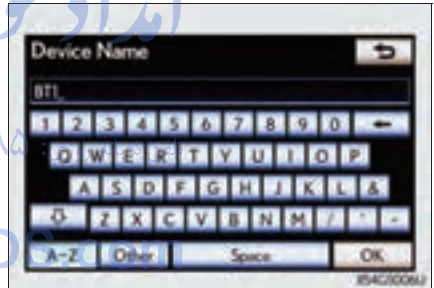

- 7 Confirm the device name and select "OK".

- Setting portable player connection method
  - 1 Display the “Bluetooth\*” screen. (→P. 535)
  - 2 Select “Registered Devices” on the “Bluetooth\*” screen.
  - 3 Select “Details” on the “Registered Devices” screen.
  - 4 Select the device to be edited.
  - 5 Select “Connect Portable Player from”.

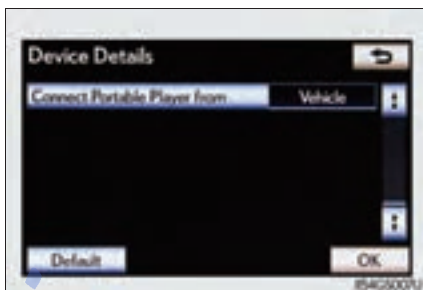

- 6 Select the desired connection method, and select “OK”.

“Vehicle”: Select to connect the audio system to the portable player.

“Portable Player”: Select to connect the portable player to the audio system.

Depending on the portable player, the “Vehicle” or “Portable Player” connection method may be best. As such, refer to the manual that comes with the portable player.

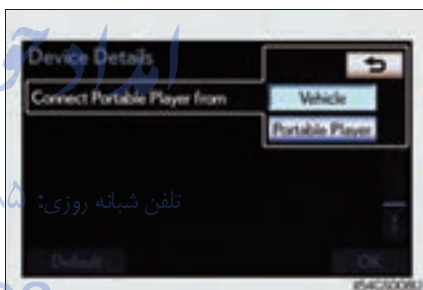

\*: Bluetooth is a registered trademark of Bluetooth SIG. Inc.

### ■ Editing the “Device Name”

If you change a device name, the name registered in your cellular phone is not changed.

### ■ About “Device Address”

The address peculiar to the system. It cannot be changed. If you have registered two Bluetooth® phones with the same device name and you cannot distinguish one from the other, refer to this address.

### ■ “My Phone Number”:

The phone number of the Bluetooth® phone is displayed on the screen. Depending on the type of phone, the phone number may not be displayed.

### ■ “Profiles”:

The compatibility profile of the Bluetooth® device is displayed on the screen.

### ■ “Connect Portable Player from”:

There are 2 portable player connection settings available; “Vehicle” and “Portable Player”.

### ■ When you delete a Bluetooth® phone

The phonebook data will be deleted at the same time.

تلفن شبانه روزی: ۰۲۱-۸۸۶۲۰۸۵

FarmaSOS.com

## Selecting a Bluetooth® phone

If multiple Bluetooth® phones are registered, follow the procedure below to select the Bluetooth® phone to be used. You can only use one phone at a time.

- 1 Display the “Bluetooth\*” screen. (→P. 535)
- 2 Select “Connect Phone” on the “Bluetooth\*” screen.
- 3 Choose the phone to be connected.

The Bluetooth® mark is displayed when you connect the phone.

If a completion message is displayed, connection is complete.

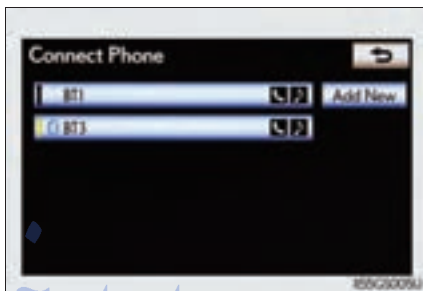

\*: Bluetooth is a registered trademark of Bluetooth SIG, Inc.

### ■ When another Bluetooth® device is connected during registering or selecting a phone

- When another Bluetooth® device is connected, a confirmation message will be displayed. If you want to disconnect it, select “Yes”.
- The currently connected Bluetooth® phone’s screen button will have a Bluetooth® mark displayed on it. If the currently connected Bluetooth® phone’s screen button is selected, the Bluetooth® phone can be disconnected. Select “Yes” to disconnect.

### ■ Connecting the phone while Bluetooth® audio is playing

Bluetooth® audio will stop temporarily.

## Selecting a portable player

If multiple portable players are registered, follow the procedure below to select the portable player phone to be used. You can only use one portable player at a time.

- 1 Display the “Bluetooth\*” screen. (→P. 535)
- 2 Select “Connect Portable Player” on the “Bluetooth\*” screen.
- 3 Choose the portable player to be used.

The Bluetooth® mark is displayed when you connect the portable player.

If a completion message is displayed, connection is complete.

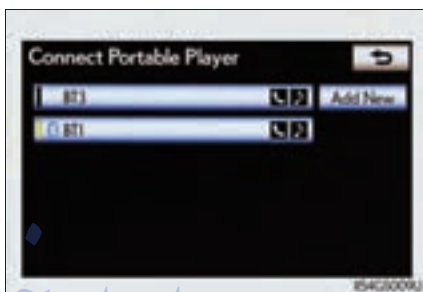

\*: Bluetooth is a registered trademark of Bluetooth SIG, Inc.

### ■ When another Bluetooth® device is connected during registering or selecting a portable player

- When another Bluetooth® device is connected, a confirmation message will be displayed. If you want to disconnect it, select “Yes”.
- The currently connected portable player’s screen button will have a Bluetooth® mark displayed on it. If the currently connected portable player’s screen button is selected, the portable player can be disconnected. Select “Yes” to disconnect.

## Detailed Bluetooth® settings

You can confirm and change the Bluetooth® settings.

▶ Page 1

▶ Page 2

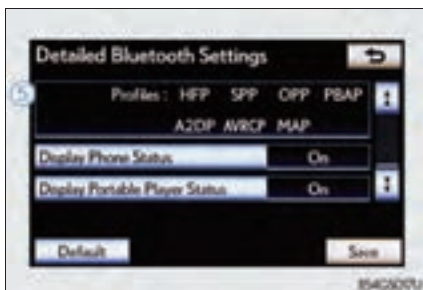
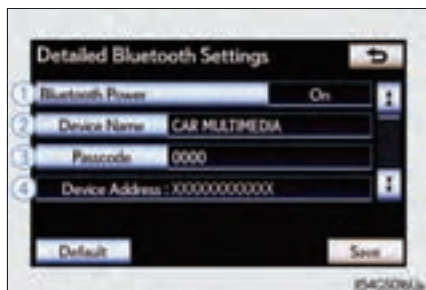

- ① Changing the device connection status
- ② Changing the name of the connected device.
- ③ Changing the passcode that you registered your Bluetooth® device in the system
- ④ The address peculiar to the system

You cannot change this address. If the same device name is displayed on the screen of your device, refer to it.

- ⑤ The compatibility profile of the Bluetooth® device

To display the screen above, follow the steps below.

- 1 Display the "Bluetooth\*" screen. (→P. 535)
- 2 Select "Detailed Bluetooth\* Settings" on the "Bluetooth\*" screen.

\*: Bluetooth is a registered trademark of Bluetooth SIG, Inc.

### ■ Changing Bluetooth\* power

The Bluetooth\* device is automatically connected when you turn the engine switch to ACCESSORY or IGNITION ON mode. You can change between “On” or “Off”.

- 1 Display the “Detailed Bluetooth\* Settings” screen. (→P. 544)
- 2 Select “Bluetooth\* Power” on the “Detailed Bluetooth\* Settings” screen.
- 3 Select “On” or “Off”, and then “Save”.

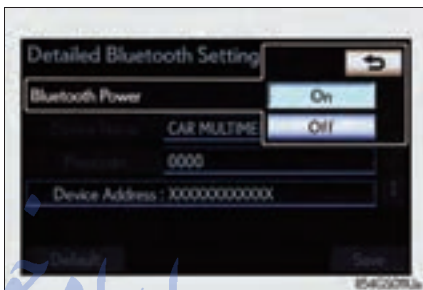

\*: Bluetooth is a registered trademark of Bluetooth SIG, Inc.

### ■ Editing the device name

- 1 Display the “Detailed Bluetooth\* Settings” screen. (→P. 544)
- 2 Select “Device Name” on the “Detailed Bluetooth\* Settings” screen.
- 3 Input the device name, and select “OK”.
- 4 Select “Save” on the “Detailed Bluetooth\* Settings” screen.

\*: Bluetooth is a registered trademark of Bluetooth SIG, Inc.

### ■ Editing the passcode

- 1 Display the “Detailed Bluetooth\* Settings” screen. (→P. 544)
- 2 Select “Passcode” on the “Detailed Bluetooth\* Settings” screen.
- 3 Input a passcode, and select “OK”.

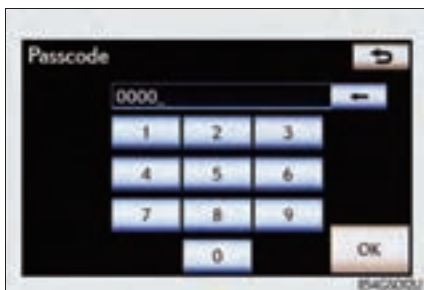

- 4 Select “Save” on the “Detailed Bluetooth\* Settings” screen.

\*: Bluetooth is a registered trademark of Bluetooth SIG, Inc.

### ■ Bluetooth® device connection status display settings

When “Bluetooth\* Power” is “On” and the engine switch is in ACCESSORY or IGNITION ON mode, the Bluetooth® phone and portable player’s connection status can be displayed.

(→P. 545)

تلفن شبانه روزی: ۰۲۱-۸۸۶۲۰۸۵

- 1 Display the “Detailed Bluetooth\* Settings” screen. (→P. 544)
- 2 Select “Display Phone Status” or “Display Portable Player Status” on the “Detailed Bluetooth\* Settings” screen.
- 3 Select “On”, and then “Save”.

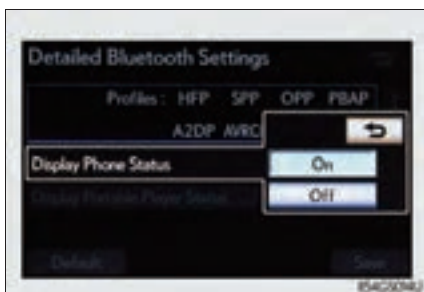

\*: Bluetooth is a registered trademark of Bluetooth SIG, Inc.



**■ While driving**

You cannot change the state of "Bluetooth\* Power" from "On" to "Off" while driving, but it can be changed from "Off" to "On".

**■ To return to the default Bluetooth® settings**

Select "Default", and then "Yes".

If the state of "Bluetooth\* Power" is changed from "Off" to "On", Bluetooth® connection will begin.

\*: Bluetooth is a registered trademark of Bluetooth SIG. Inc.

امداد خودرو فارما

تلفن شبانه روزی: ۰۲۱-۸۸۸۶۲۰۸۵

FarmaSOS.com

## Interior lights list

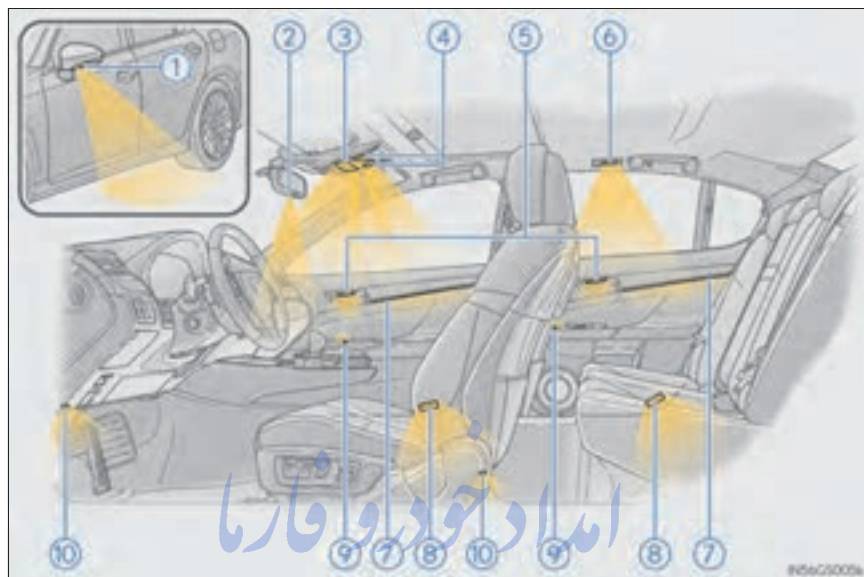

- |                             |  |
|-----------------------------|--|
| ① Outer foot lights         | ⑥ Rear personal lights (→P. 549)       |
| ② Shift lever light         | ⑦ Ornament lights                      |
| ③ Interior light (→P. 549)  | ⑧ Door courtesy lights                 |
| ④ Front personal lights     | ⑨ Power window switch lights (→P. 549) |
| ⑤ Inside door handle lights | ⑩ Footwell lights                      |

When the instrument panel light control switch is turned to minimum and the tail lights are on, the inside door handle lights, the ornament lights and the footwell lights will turn off. (→P. 80)

## Interior light

### ① Turns the light on/off

The rear personal lights are also turned on/off by the interior light operation. However, if the interior light is turned off after being turned on while the rear personal lights are turned on, the rear personal lights will not turn off simultaneously.

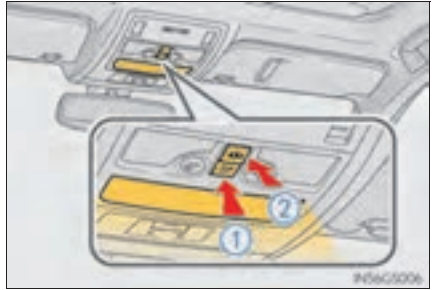

### ② Turns the door position on

## Personal lights

### ■ Front

Turns the light on/off

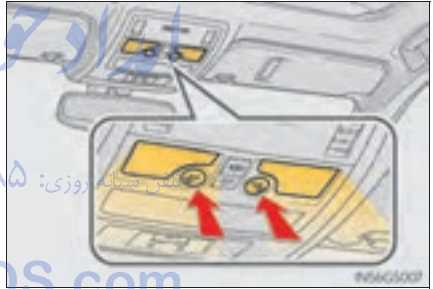

### ■ Rear

Turns the light on/off

If the lights are turned on by interior light operation, the lights cannot turn off by pressing the switch.

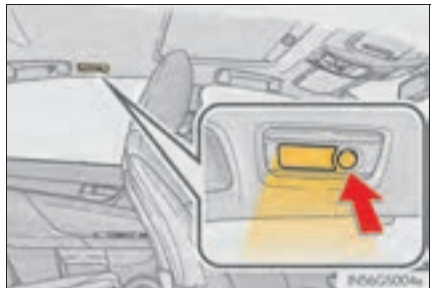

### ■ Illuminated entry system

The lights automatically turn on/off according to engine switch mode, the presence of the electronic key, whether the doors are locked/unlocked, and whether the doors are opened/closed.

### ■ To prevent battery discharge

If the interior lights remain on when the engine switch is turned off, the lights will go off automatically after 20 minutes.

### ■ Customization

Setting (e.g. the time elapsed before lights turn off) can be changed.

(Customizable features: →P. 777)



### NOTICE

#### ■ To prevent battery discharge

Do not leave the lights on longer than necessary when the engine is not running.

امداد خودرو فارما

تلفن شبانه روزی: ۰۲۱-۸۸۶۲۰۸۵

FarmaSOS.com

## List of storage features

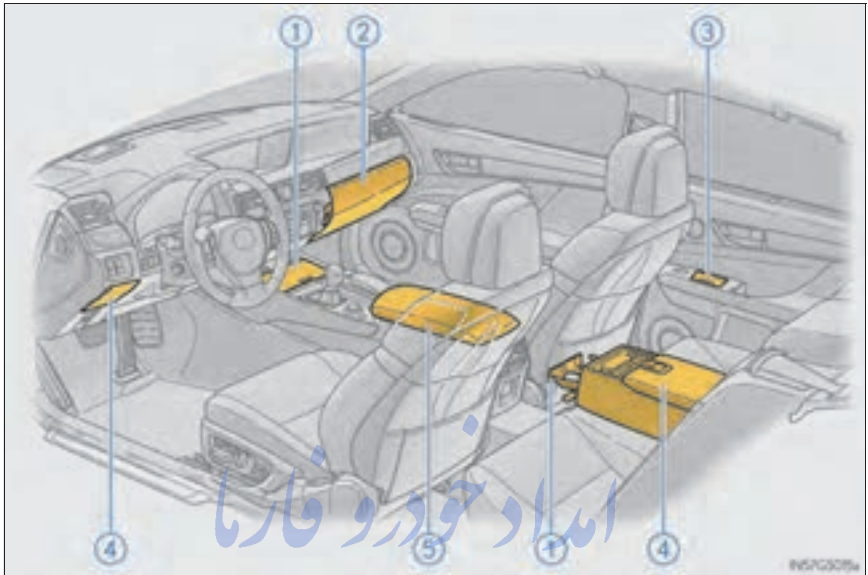

- ① Cup holders (→P. 555)      ④ Auxiliary boxes (→P. 557)  
 ② Glove box (→P. 553)      ⑤ Console box (→P. 554)  
 ③ Auxiliary boxes (if equipped)  
     (→P. 557)  
 Ashtrays (if equipped)  
     (→P. 563)

**⚠ CAUTION****■ Items that should not be left in the storage spaces**

Do not leave glasses, lighters or spray cans in the storage spaces, as this may cause the following when cabin temperature becomes high:

- Glasses may be deformed by heat or cracked if they come into contact with other stored items.
- Lighters or spray cans may explode. If they come into contact with other stored items, the lighter may catch fire or the spray can may release gas, causing a fire hazard.

**■ When driving or when the storage compartments are not in use**

Keep the lids closed.

In the event of sudden braking or sudden swerving, an accident may occur due to an occupant being struck by an open lid or the items stored inside.

امداد خودرو فارما

تلفن شبانه روزی: ۰۲۱-۸۸۶۲۰۸۵

FarmaSOS.com

## Glove box

- ① Open (press the button)
- ② Unlock with the mechanical key
- ③ Lock with the mechanical key

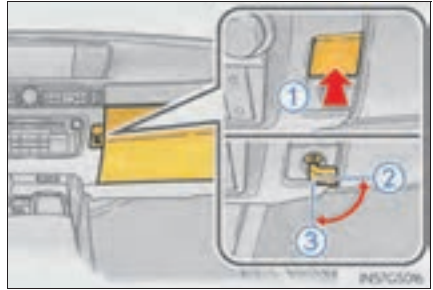

### ■ Glove box light

The glove box light turns on when the tail lights are on.

### ■ Trunk opener main switch

The trunk opener main switch is located in the glove box. (→P. 122)

### ■ Removing the insert

The insert inside the glove box can be removed.

### ■ The glove box door

An SRS knee airbag for the front passenger's seat is built into the glove box door. (→P. 36)

تلفن شبانه روزی: ۰۲۱-۸۸۶۲۰۸۵

FarmaSOS.com

## Console box

- ① Using with half-open  
Grip the knob to release the lock, and slide the armrest as far back.
- ② Using with fully open  
Grip the knob to release the lock, and lift the armrest to open.

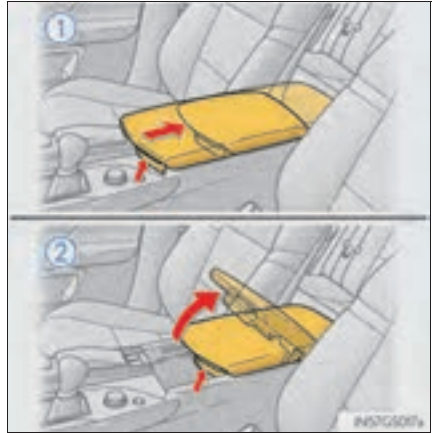

### ■ Tray in the console box

The tray slides forward/backward and can be removed.

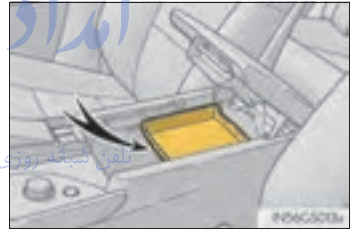

### ■ Console box light

The console box light turns on when the tail lights are on.

FarmaSOS.com

## ⚠ CAUTION

When using the console box with half-open, do not apply too much load on the armrest. Doing so may damage the armrest and may cause you to injure yourself.



## Cup holders

### ■ Front

To open, press down and release the cup holder lid.



### ■ Rear

To open, pull down the armrest and press in and release the rear cup holder on the armrest.

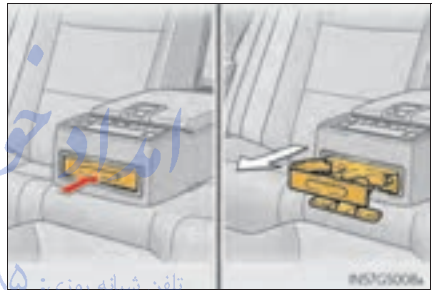

### ■ Removing the separate tray (front cup holder)

The cup holder insert may be removed for cleaning.



### ■ When stowing the cup holders (rear cup holder)

Stow the cup holder with the armrest down. The cup holder cannot be stowed if the armrest is not down.

 CAUTION**■ Items unsuitable for the cup holders**

Do not place anything other than cups or aluminum cans in the cup holders. Other items may be thrown out of the holders in the event of an accident or sudden braking, causing injury. If possible, cover hot drinks to prevent burns.

 NOTICE**■ To prevent damage to the rear cup holder**

Stow the cup holder before stowing the armrest.

امداد خودرو فارما

تلفن شبانه روزی: ۰۲۱-۸۸۶۲۰۸۵

FarmaSOS.com

## Auxiliary boxes

### ► Type A

Press in the button.



### ► Type B

Pull up the lever to release the lock and lift the lid.

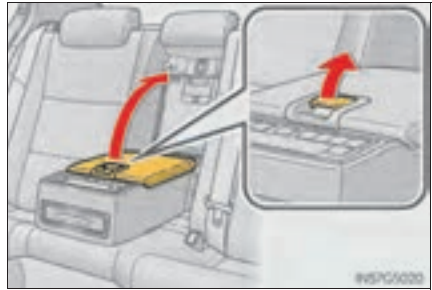

### ► Type C (if equipped)

Open the lid.

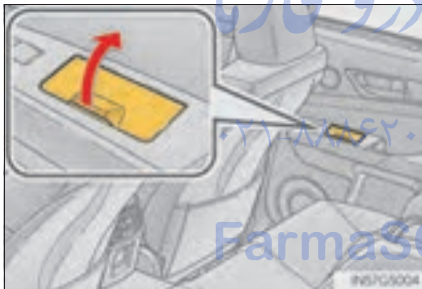

## ⚠ CAUTION

### ■ Using the auxiliary boxes (type C)

Do not use the auxiliary box as an ashtray.  
Doing so may cause a fire.

## Trunk features

### Cargo hooks

Raise the hooks when needed.

The cargo hooks are provided for securing loose items.

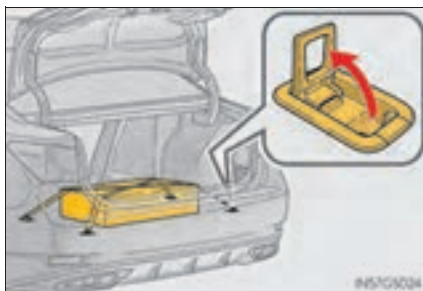

### Luggage hook

Pull the strap when using the hook.

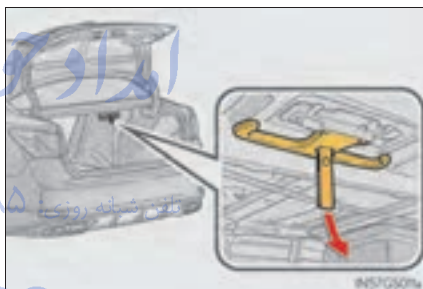

### First-aid kit storage net

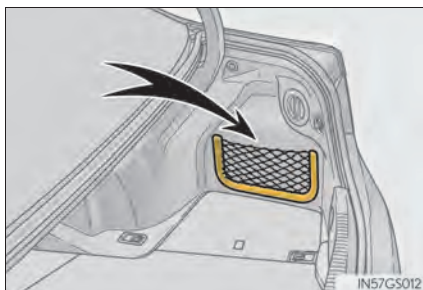

## Luggage mat

### ■ Center

Pull the strap upwards to lift up the luggage mat.

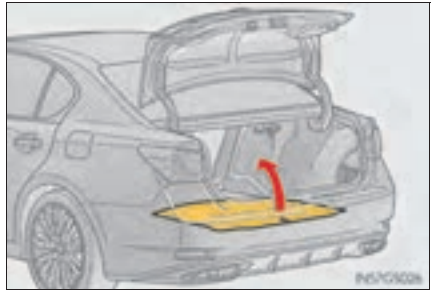

### ■ Left side

Pull the strap upwards when lifting the luggage mat up.

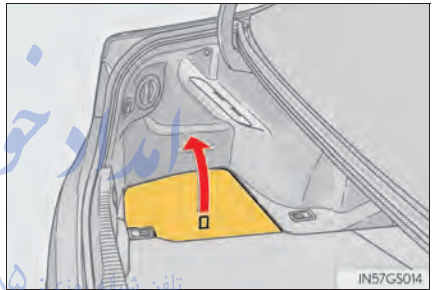

امداد خودرو فارما

تلفن: ۰۲۱-۸۸۶۲۰۸۵

FarmaSOS.com

### Warning reflector storage belt

- ① Loosen the belt
- ② Tighten the belt

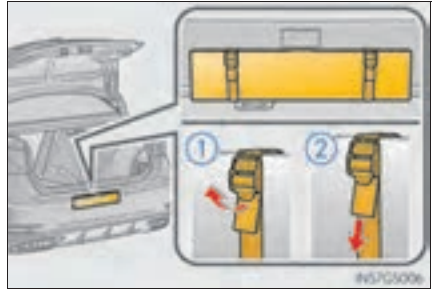

### ⚠ CAUTION

#### ■ When the cargo hooks are not in use

To avoid injury, always return the cargo hooks to their stowed positions.

### ⚠ NOTICE

#### ■ Luggage hook weight capacity

Do not hang any object heavier than 11 lb. (5 kg) on the luggage hook.

امداد خودرو فارما

تلفن شبانه روزی: ۰۲۱-۸۸۶۲۰۸۵

FarmaSOS.com

## Sun visors and vanity mirrors

### Sun visors

- ① To set the visor in the forward position, flip it down.
- ② To set the visor in the side position, flip down, unhook, and swing it to the side.
- ③ To use the side extender, place the visor in the side position, then slide it backward.

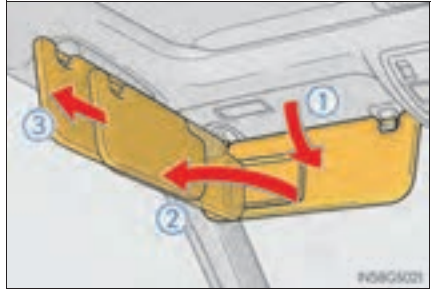

### Vanity mirrors

Slide the cover to open.

The light turns on when the cover is opened.

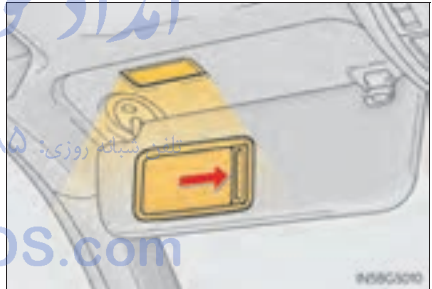

### ⚠ NOTICE

#### ■ To prevent battery discharge

Do not leave the vanity lights on for extended periods while the engine is off.

## Clock

The clock can be adjusted by pressing the buttons.

- ① Pressing and holding will move the clock hands backward.
- ② Pressing and holding will move the clock hands forward.

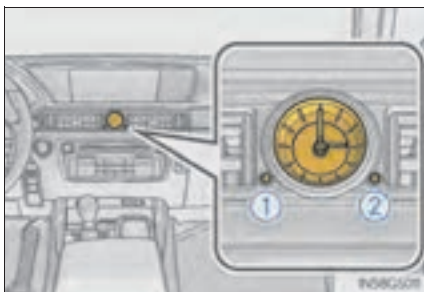

امداد خودرو فارما

تلفن شبانه روزی: ۰۲۱-۸۸۶۲۰۸۵

FarmaSOS.com



## Ashtrays\*

Open the ashtray lid.

To remove the ashtray, pull the ashtray lid upwards.

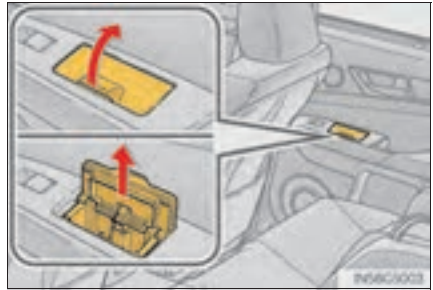

### ⚠ CAUTION

#### ■ When not in use

Keep the ashtray closed. In the event of sudden braking or sudden swerving, an accident may occur due to an occupant being struck by the open ashtray or ash flying out.

#### ■ To prevent fire

- Fully extinguish matches and cigarettes before putting them in the ashtray, then make sure the ashtray is fully closed.
- Do not place paper or any other type of flammable object in the ashtray.

FarmaSOS.com

## Power outlets

The power outlets can be used for 12V accessories that run on less than 10A.

### ■ Front

Open the lid.



### ■ Rear

Open the lid.



### ■ The power outlets can be used when

The engine switch is in ACCESSORY or IGNITION ON mode.

 NOTICE**■ To avoid damaging the power outlets**

Close the power outlet lids when the power outlets are not in use.  
Foreign objects or liquids that enter the power outlets may cause a short circuit.

**■ To prevent blown fuse**

Do not use an accessory that uses more than 12V 10A.

**■ To prevent battery discharge**

Do not use the power outlets longer than necessary when the engine is off.

امداد خودرو فارما

تلفن شبانه روزی: ۰۲۱-۸۸۶۲۰۸۵

FarmaSOS.com

## Heated steering wheel\*

The heated steering wheel heats the side grips of the steering wheel.

Turns the heater on/off

The indicator light comes on when the heater is operating.

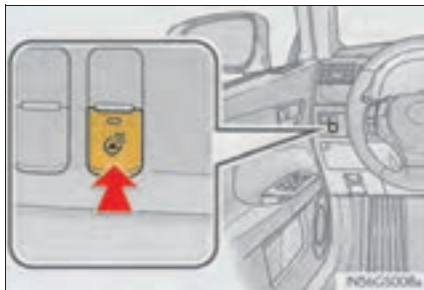

### ■ Operating condition

The engine switch is in IGNITION ON mode.

### ■ Timer

The heated steering wheel will automatically turn off after about 30 minutes.

### ■ If the indicator light flashes

Press the button to turn the heated steering wheel off and then press the button again. If the indicator light still flashes, a malfunction may be occurring. Turn the heated steering wheel off and have the vehicle inspected by your Lexus dealer.

 CAUTION**■ Burns**

Care should be taken to prevent injury if anyone in the following categories comes in contact with the steering wheel when the heated steering wheel is on:

- Babies, small children, the elderly, the sick and the physically challenged
- Persons with sensitive skin
- Persons who are fatigued
- Persons who have taken alcohol or drugs that induce sleep (sleeping drugs, cold remedies, etc.)

 NOTICE**■ To prevent the battery from being discharged**

Turn the switch off when the engine is not running.

امداد خودرو فارما

تلفن شبانه روزی: ۰۲۱-۸۸۶۲۰۸۵

FarmaSOS.com

## Seat heaters\* /seat ventilators\*

The seat heaters and ventilators heat the seats and maintain good air-flow by blowing air from the seats.

### Seat heaters

#### ■ Front seats

Turns the seat heater on

- ① Hi
- ② Mid
- ③ Lo
- ④ Off

The indicator light (yellow) on the switch and the level indicator lights (green) come on.



#### ■ Rear seats (if equipped)

Turns the seat heater on

- ① Hi
- ② Mid
- ③ Lo
- ④ Off

The level indicator lights (yellow) come on.



## Seat ventilators (front seats only)

Blows air from the seat

- ① Hi
- ② Mid
- ③ Lo
- ④ Off

The indicator light (green) on the switch and the level indicator lights (green) come on.



### ■ The seat heaters/seat ventilators can be used when

The engine switch is in IGNITION ON mode.

### ■ The seat heater timer control

The seat heater automatically switches from Hi → Mid → Lo → Off. The switching timing differs depending on the temperature inside the cabin etc. when the seat heater was operated.

### ■ Automatic operation of the seat heater during Eco drive mode

If the driving mode select switch is switched to Eco drive mode in cold temperatures, the seat heater may be automatically operated to assist heating performance.

### ■ Button lock function (vehicles with rear control panel)

To prevent inadvertent operation, some buttons on the rear armrest can be locked. (→P. 364)

### ■ Rear control panel illumination off function (vehicles with rear control panel)

Control panel illumination on the rear armrest can be turned off. (→P. 364)

 CAUTION**■ Burns**

- Use caution when seating the following persons in a seat with the seat heater on to avoid the possibility of burns:
  - Babies, small children, the elderly, the sick and the physically challenged
  - Persons with sensitive skin
  - Persons who are fatigued
  - Persons who have taken alcohol or drugs that induce sleep (sleeping drugs, cold remedies, etc.)
- Do not cover the seat with anything when using the seat heater.  
Using the seat heater with a blanket or cushion increases the temperature of the seat and may lead to overheating.
- Do not use seat heater more than necessary. Doing so may cause minor burns or overheating.

 NOTICE**■ To prevent damage to the seat heaters/seat ventilators**

Do not put heavy objects that have an uneven surface on the seat and do not stick sharp objects (needles, nails, etc.) into the seat.

**■ To prevent battery discharge**

Turn the seat heaters/seat ventilators off when the engine is off.



## Armrest

Fold down the armrest for use.



### NOTICE

**■ To prevent damage to the armrest**

Do not apply too much load on the armrest.

امداد خودرو فارما

تلفن شبانه روزی: ۰۲۱-۸۸۶۲۰۸۵

FarmaSOS.com

## Rear sunshade\* /rear door sunshades\*

### Rear sunshade

The rear sunshade can be raised and lowered by operating the button shown below.

#### ■ From the front seats

- ① Pull up the lever to release the lock.
- ② Slide the armrest.
- ③ Raise/lower



#### ■ From the rear seats (if equipped)

Raise/lower



\*: If equipped

## Rear door sunshades

Pull the tab of the rear door sunshade and hook the shade on using the anchors.

To retract the rear door sunshade, unhook the shade and retract it slowly.

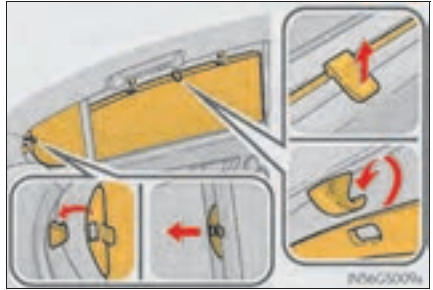

### ■ The rear sunshade can be used when

The engine switch is in IGNITION ON mode.

### ■ Operating the rear sunshade after the engine is turned off

The rear sunshade can be operated for approximately 1 minute even after the engine switch is turned to ACCESSORY mode or turned off.

### ■ Reverse operation feature

To ensure adequate rear visibility, the rear sunshade automatically lowers when the shift lever is shifted to R.

However, the rear sunshade is raised again if any of the following occurs:

- The button is pressed again.\*
- Shift the shift lever into P.
- The shift lever is shifted out of R, and the vehicle reaches a speed of 9 mph (15 km/h).

If the engine is off when the rear sunshade has been lowered due to the reverse operation feature, it will not be raised even when the engine is turned on again and the vehicle reaches a speed of 9 mph (15 km/h). To raise the sunshade again, press the button.

\*: Occasionally, the reverse function may not be carried out after the switch has been pressed. Repeat the above operation to operate the function.

■ **Button lock function (vehicles with rear control panel)**

To prevent inadvertent operation, some buttons on the rear armrest can be locked.  
(→P. 364)

■ **Rear control panel illumination off function (vehicles with rear control panel)**

Control panel illumination on the rear armrest can be turned off. (→P. 364)

■ **Customization**

Time elapsed before the reverse operation feature activates can be changed.  
(Customizable features: →P. 777)

 **CAUTION**

■ **When the rear sunshade is being operated**

Do not place fingers or other objects in the fastener section or in the opening.  
They may get caught, causing injury.

 **NOTICE**

■ **To prevent battery discharge**

Do not operate the rear sunshade when the engine is off.

■ **To ensure normal operation of the rear sunshade and rear door sunshades**

Observe the following precautions.

- Do not place excessive load on the motor or other components of the rear sunshade.
- Do not place objects where they may hinder opening and closing operations.
- Do not attach items to the rear sunshade and rear door sunshades.
- Keep the opening clean and clear of obstructions.
- Do not operate the rear sunshade continuously for long periods of time.

## Trunk storage extension

Long objects can be loaded into the vehicle by utilizing the trunk space and rear seat area.

- 1 Fold down the armrest.



- 2 Fold down the handle and open the armrest door.

The armrest door can be locked and unlocked using the mechanical key.

- 1 Unlock
- 2 Lock

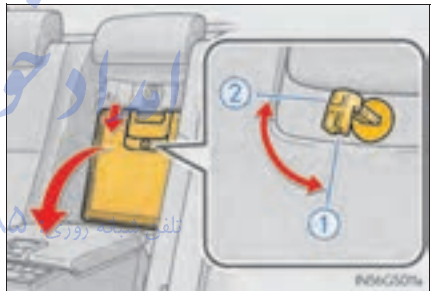

FarmaSOS.com

### ⚠ CAUTION

#### ■ When not in use

Ensure that the armrest door is closed.

In the event of sudden braking, items stored in the trunk may be thrown forward into the cabin, resulting in injury.

## Coat hooks

The coat hooks are provided with the rear assist grips.



### CAUTION

#### ■ Items that cannot be hung on the coat hook

Do not hang coat hangers or other hard or sharp objects on the hook. If the SRS curtain shield airbags deploy, these items may become projectiles, causing death or serious injury.

تلفن شبانه روزی: ۰۲۱-۸۸۶۲۰۸۵

FarmaSOS.com

## Assist grip

An assist grip installed at the ceiling can be used to support your body while sitting on the seat.



### ⚠ CAUTION

#### ■ Assist grip

Do not use the assist grip when getting on or off the vehicle or rising from your seat.

### ⚠ NOTICE

#### ■ To prevent damage to the assist grip

Do not hang any heavy object or put a heavy load on the assist grip.

تلفن شبانه روزی: ۰۸۵ +۹۸۴۲۰۲۱  
FarmaSOS.com

## Utility hook\*

To use the utility hook, push it on.



### ⚠ CAUTION

#### ■ When not in use

Keep the utility hook stowed.  
Injuries may result in the event of an accident or sudden braking.

### ⚠ NOTICE

#### ■ Utility hook weight capacity تلفن شبانه روزی: ۸۵۰۶۲۰۸۵

Do not hang any object heavier than 4.4 lb. (2 kg) on the utility hook.  
The utility hook may get damaged or the object hooked on the utility hook may fall down while driving.



## Garage door opener\*

The garage door opener can be programmed to operate garage doors, gates, entry doors, door locks, home lighting systems, security systems, and other devices.

The garage door opener (HomeLink® Universal Transceiver) is manufactured under license from HomeLink®.

### Programming the HomeLink® (for U.S.A. owners)

The HomeLink® compatible transceiver in your vehicle has 3 buttons which can be programmed to operate 3 different devices. Refer to the programming method below appropriate for the device.

- ① Indicator light
- ② Buttons

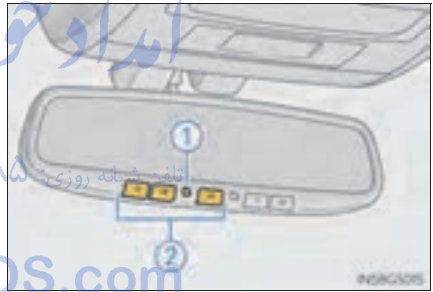

## ■ Programming HomeLink®

- 1 Point the remote control transmitter for the device 1 to 3 in. (25 to 75 mm) from the HomeLink® buttons.

Keep the HomeLink® indicator light in view while programming.



- 2 Press and hold one of the HomeLink® buttons and the transmitter button. When the HomeLink® indicator light changes from a slow to a rapid flash, you can release both buttons.

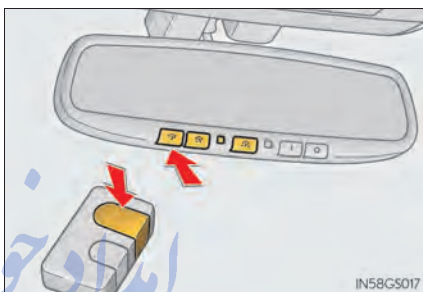

If the HomeLink® indicator light comes on but does not flash, or flashes rapidly for 2 seconds and remains lit, the HomeLink® button is already programmed. Use the other buttons or follow the "Reprogramming a HomeLink® button" instructions. (→P. 583)

تلفن شبانه روزی: ۰۲۱-۸۵۰۰۰۰۰۰

FamilyOS.com

- 3** Test the HomeLink<sup>®</sup> operation by pressing the newly programmed button.

If a HomeLink<sup>®</sup> button has been programmed for a garage door, check to see if the garage door opens and closes. If the garage door does not operate, see if your garage transmitter is of the rolling code type. Press and hold the programmed HomeLink<sup>®</sup> button. The remote control transmitter is of the rolling code type if the HomeLink<sup>®</sup> indicator light flashes rapidly for 2 seconds and then remains lit. If your transmitter is the rolling code type, proceed to the heading "Programming a rolling code system".



- 4** Repeat the steps above to program another device for any of the remaining HomeLink<sup>®</sup> buttons.

#### ■ Programming a rolling code system (for U.S.A. owners)

If your device is rolling code equipped, follow the steps under the heading "Programming HomeLink<sup>®</sup>" before proceeding with the steps listed below.

- 1** Locate the training button on the ceiling mounted garage door opener motor. The exact location and color of the button may vary by brand of garage door opener motor.

Refer to the operation manual supplied with the garage door opener for the location of the training button.

- 2** Press the training button.

Following this step, you have 30 seconds in which to initiate step **3** below.

- 3 Press and hold the vehicle's programmed HomeLink<sup>®</sup> button for 2 seconds and release it. Repeat this step once again. The garage door may open.

If the garage door opens, the programming process is complete. If the door does not open, press and release the button a third time. This third press and release will complete the programming process by opening the garage door.

The ceiling mounted garage door opener motor should now recognize the HomeLink<sup>®</sup> signal and operate the garage door.

- 4 Repeat the steps above to program another rolling code system for any of the remaining HomeLink<sup>®</sup> buttons.

#### ■ Programming an entry gate (for U.S.A. owners)/Programming a devices in the Canadian market

- 1 Place the remote control transmitter 1 to 3 in. (25 to 75 mm) away from the HomeLink<sup>®</sup> buttons.

Keep the HomeLink<sup>®</sup> indicator light in view while programming.

- 2 Press and hold the selected HomeLink<sup>®</sup> button.
- 3 Repeatedly press and release (cycle) the remote control transmitter for 2 seconds each until step 4 is completed.
- 4 When the HomeLink<sup>®</sup> indicator light starts to flash rapidly, release the buttons.
- 5 Test the HomeLink<sup>®</sup> operation by pressing the newly programmed button. Check to see if the gate/device operates correctly.
- 6 Repeat the steps above to program another device for any of the remaining HomeLink<sup>®</sup> buttons.

#### ■ Programming other devices

To program other devices such as home security systems, home door locks and lighting, contact your Lexus dealer for assistance.

#### ■ Reprogramming a button

The individual HomeLink<sup>®</sup> buttons cannot be erased but can be reprogrammed. To reprogram a button, follow the "Reprogramming a HomeLink<sup>®</sup> button" instructions.

## Operating HomeLink®

Press the appropriate HomeLink® button. The HomeLink® indicator light should come on.

The HomeLink® compatible transceiver in your vehicle continues to send a signal for up to 20 seconds as long as the button is pressed.

## Reprogramming a HomeLink® button

Press and hold the desired HomeLink® button. After 20 seconds, the HomeLink® indicator light will start flashing slowly. Keep pressing the HomeLink® button and press and hold the transmitter button until the HomeLink® indicator light changes from a slow to a rapid flash. Release the buttons.

## Erasing the entire HomeLink® memory (all three programs)

Press and hold the 2 outside buttons for 10 seconds until the indicator light flashes.

If you sell your vehicle, be sure to erase the programs stored in the HomeLink® memory.



**■ Before programming**

- Install a new battery in the remote control transmitter.
- The battery side of the remote control transmitter must be pointed away from the HomeLink<sup>®</sup> button.

**■ Certification for the garage door opener**

- ▶ For vehicles sold in the U.S.A.

FCC ID: NZLOBIHL4

**NOTE:**

This device complies with Part 15 of the FCC Rules. Operation is subject to the following two conditions: (1) this device may not cause harmful interference, and (2) this device must accept any interference received, including interference that may cause undesired operation.

**FCC WARNING:**

Changes or modifications not expressly approved by the party responsible for compliance could void the user's authority to operate the equipment.

- ▶ For vehicles sold in Canada

**NOTE:**

Operation is subject to the following two conditions:

- (1) this device may not cause interference, and
- (2) this device must accept any interference, including interference that may cause undesired operation.

**■ When support is necessary**

Visit on the web at [www.homelink.com](http://www.homelink.com) or call 1-800-355-3515.

**⚠ CAUTION****■ When programming a garage door or other remote control device**

The garage door or other device may operate, so ensure people and objects are out of danger to prevent potential harm.

**■ Conforming to federal safety standards**

Do not use the HomeLink<sup>®</sup> compatible transceiver with any garage door opener or device that lacks safety stop and reverse features as required by federal safety standards.

This includes any garage door that cannot detect an interfering object. A door or device without these features increases the risk of death or serious injury.

امداد خودرو فارما

تلفن شبانه روزی: ۰۲۱-۸۸۶۲۰۸۵

FarmaSOS.com

## Safety Connect\*

Safety Connect is a subscription-based telematics service that uses Global Positioning System (GPS) data and embedded cellular technology to provide safety and security features to subscribers. Safety Connect is supported by Lexus' designated response center, which operates 24 hours per day, 7 days per week.

Safety Connect service is available by subscription on select, telematics hardware-equipped vehicles.

By using the Safety Connect service, you are agreeing to be bound by the Telematics Subscription Service Agreement and its Terms and Conditions, as in effect and amended from time to time, a current copy of which is available at Lexus.com. All use of the Safety Connect service is subject to such then-applicable Terms and Conditions.

### System components

- ① "SOS" button
- ② LED light indicators
- ③ Microphone



\*: If equipped



## Services

Subscribers have the following Safety Connect services available:

- Automatic Collision Notification\*  
Helps drivers receive necessary response from emergency service providers. (→P. 589)  
\*: U.S. Patent No. 7,508,298 B2
- Stolen Vehicle Location  
Helps drivers in the event of vehicle theft. (→P. 590)
- Emergency Assistance Button (“SOS”)  
Connects drivers to response-center support. (→P. 590)
- Enhanced Roadside Assistance  
Provides drivers various on-road assistance. (→P. 590)

## Subscription

After you have signed the Telematics Subscription Service Agreement and are enrolled, you can begin receiving services.

A variety of subscription terms is available for purchase. Contact your Lexus dealer, call 1-800-25-LEXUS (1-800-255-3987) or push the “SOS” button in your vehicle for further subscription details.

### ■ Safety Connect Services Information

- Phone calls using the vehicles Bluetooth® technology will not be possible during Safety Connect.
- Safety Connect is available beginning Fall 2009 on select Lexus models. Contact with the Safety Connect response center is dependent upon the telematics device being in operative condition, cellular connection availability, and GPS satellite signal reception, which can limit the ability to reach the response center or receive emergency service support. Enrollment and Telematics Subscription Service Agreement required. A variety of subscription terms is available; charges vary by subscription term selected.
- Automatic Collision Notification, Emergency Assistance and Stolen Vehicle Location will function in the United States, including Hawaii and Alaska, and in Canada, and Enhanced Roadside Assistance will function in the United States (except Hawaii) and in Canada. No Safety Connect services will function outside of the United States in countries other than Canada.
- Safety Connect services are not subject to section 255 of the Telecommunications Act and the device is not TTY compatible.

### ■ Languages

The Safety Connect response center will offer support in multiple languages. The Safety Connect system will offer voice prompts in English and Spanish. Please indicate your language of choice when enrolling.

### ■ When contacting the response center

You may be unable to contact the response center if the network is busy.

امداد خودرو فارما

تلفن شبانه روزی: ۰۲۱-۸۸۸۸۸۸۸۸

FarmaSOS.com

## Safety Connect LED light Indicators

When the engine switch is turned to IGNITION ON mode, the red indicator light comes on for 2 seconds then turns off. Afterward, the green indicator light comes on, indicating that the service is active.

The following indicator light patterns indicate specific system usage conditions:

- Green indicator light on = Active service
- Green indicator light flashing = Safety Connect call in process
- Red indicator light (except at vehicle start-up) = System malfunction (contact your Lexus dealer)
- No indicator light (off) = Safety Connect service not active

## Safety Connect services

### ■ Automatic Collision Notification

In case of either airbag deployment or severe rear-end collision, the system is designed to automatically call the response center. The responding agent receives the vehicle's location and attempts to speak with the vehicle occupants to assess the level of emergency. If the occupants are unable to communicate, the agent automatically treats the call as an emergency, contacts the nearest emergency services provider to describe the situation, and requests that assistance be sent to the location.

### ■ Stolen Vehicle Location

If your vehicle is stolen, Safety Connect can work with local authorities to assist them in locating and recovering the vehicle. After filing a police report, call the Safety Connect response center at 1-800-25-LEXUS (1-800-255-3987) and follow the prompts for Safety Connect to initiate this service.

In addition to assisting law enforcement with recovery of a stolen vehicle, Safety-Connect-equipped vehicle location data may, under certain circumstances, be shared with third parties to locate your vehicle. Further information is available at [Lexus.com](http://Lexus.com).

### ■ Emergency Assistance Button (“SOS”)

In the event of an emergency on the road, push the “SOS” button to reach the Safety Connect response center. The answering agent will determine your vehicle’s location, assess the emergency, and dispatch the necessary assistance required.

If you accidentally press the “SOS” button, tell the response-center agent that you are not experiencing an emergency.

### ■ Enhanced Roadside Assistance

Enhanced Roadside Assistance adds GPS data to the already included warranty-based Lexus roadside service.

Subscribers can press the “SOS” button to reach a Safety Connect response-center agent, who can help with a wide range of needs, such as: towing, flat tire, fuel delivery, etc. For a description of the Roadside Assistance services and their limitations, please see the Safety Connect Terms and Conditions, which are available at [Lexus.com](http://Lexus.com).

## Safety information for Safety Connect

Important! Read this information before using Safety Connect.

### ■ Exposure to radio frequency signals

The Safety Connect system installed in your vehicle is a low-power radio transmitter and receiver. It receives and also sends out radio frequency (RF) signals.

In August 1996, the Federal Communications Commission (FCC) adopted RF exposure guidelines with safety levels for mobile wireless phones. Those guidelines are consistent with the safety standards previously set by the following U.S. and international standards bodies.

- ANSI (American National Standards Institute) C95.1 [1992]
- NCRP (National Council on Radiation Protection and Measurement) Report 86 [1986]
- ICNIRP (International Commission on Non-Ionizing Radiation Protection) [1996]

Those standards were based on comprehensive and periodic evaluations of the relevant scientific literature. Over 120 scientists, engineers, and physicians from universities, and government health agencies and industries reviewed the available body of research to develop the ANSI Standard (C95.1).

The design of Safety Connect complies with the FCC guidelines in addition to those standards.

**■ Certification for Lexus Enform with Safety Connect**

FCC ID: O9EGTM1

FCC ID: O6Y-CDMRF101

**NOTE:**

This device complies with Part 15 of the FCC Rules. Operation is subject to the following two conditions: (1) This device may not cause harmful interference, and (2) this device must accept any interference received, including interference that may cause undesired operation.

**FCC WARNING:**

Changes or modifications not expressly approved by the party responsible for compliance could void the user's authority to operate the equipment.

امداد خودرو فارما

تلفن شبانه روزی: ۰۲۱-۸۸۶۲۰۸۵

[FarmaSOS.com](http://FarmaSOS.com)

<b>6-1. Maintenance and care</b>	
Cleaning and protecting the vehicle exterior .....	594
Cleaning and protecting the vehicle interior .....	598
<b>6-2. Maintenance</b>	
Maintenance requirements ....	601
General maintenance .....	604
Emission inspection and maintenance (I/M) programs .....	608
<b>6-3. Do-it-yourself maintenance</b>	
Do-it-yourself service precautions .....	609
Hood .....	612
Positioning a floor jack .....	613
Engine compartment .....	615
Tires .....	629
Tire inflation pressure .....	639
Wheels .....	642
Air conditioning filter .....	644
Electronic key battery .....	646
Checking and replacing fuses .....	648
Headlight aim .....	661
Light bulbs .....	663

ایراد خودرو فارما

تلفن شبانه روزی: ۰۲۱-۸۸۶۲۰۸۵

FarmaSOS.com

## Cleaning and protecting the vehicle exterior

Perform the following to protect the vehicle and maintain it in prime condition:

- Working from top to bottom, liberally apply water to the vehicle body, wheel wells and underside of the vehicle to remove any dirt and dust.
- Wash the vehicle body using a sponge or soft cloth, such as a chamois.
- For hard-to-remove marks, use car wash soap and rinse thoroughly with water.
- Wipe away any water.
- Wax the vehicle when the waterproof coating deteriorates.

If water does not bead on a clean surface, apply wax when the vehicle body is cool.

### ■ Automatic car washes

- Fold the mirrors before washing the vehicle. Start washing from the front of the vehicle. Make sure to extend the mirrors before driving.
- Brushes used in automatic car washes may scratch the vehicle surface and harm your vehicle's paint.
- Rear spoiler (if equipped) may not be washable in some automatic car washes. There may also be an increased risk of damage to vehicle.

### ■ High pressure car washes

- Do not allow the nozzles of the car wash to come within close proximity of the windows.
- Before using the car wash, check that the fuel filler door on your vehicle is closed properly.

### ■ When using a car wash

If the door handle becomes wet while the electronic key is within the effective range, the door may lock and unlock repeatedly. In that case, follow the following correction procedures to wash the vehicle:

- Place the key in a position 6 ft. (2 m) or more separate from the vehicle while the vehicle is being washed. (Take care to ensure that the key is not stolen.)
- Set the electronic key to battery-saving mode to disable the smart access system with push-button start. (→P. 107)



### ■ Aluminum wheels

- Remove any dirt immediately by using a neutral detergent. Do not use hard brushes or abrasive cleaners. Do not use strong or harsh chemical cleaners. Use the same mild detergent and wax as used on the paint.
- Do not use detergent on the wheels when they are hot, for example after driving for long distance in the hot weather.
- Wash detergent from the wheels immediately after use.

### ■ Bumpers

Do not scrub with abrasive cleaners.

### ■ Front side windows water-repellent coating (if equipped)

- The following precautions can extend the effectiveness of the water-repellent coating.
  - Remove any dirt, etc. from the front side windows regularly.
  - Do not allow dirt and dust to accumulate on the windows for a long period. Clean the windows with a soft, damp cloth as soon as possible.
  - Do not use wax or glass cleaners that contain abrasives when cleaning the windows.
  - Do not use any metallic objects to remove condensation build up.
- When the water-repellent performance has become insufficient, the coating can be repaired. Contact your Lexus dealer.

تلفن شبانه روزی: ۰۲۱-۸۸۶۲۰۸۵

FarmaSOS.com

**⚠ CAUTION****■ When washing the vehicle**

Do not apply water to the inside of the engine compartment. Doing so may cause the electrical components etc. to catch fire.

**■ When cleaning the windshield (with rain-sensing windshield wipers)**

Set the wipers to the intermittent windshield wipers. (→P. 200)

If AUTO mode is selected, the wipers may operate unexpectedly in the following situations, and may result in hands being caught or other serious injuries and cause damage to the wiper blades.

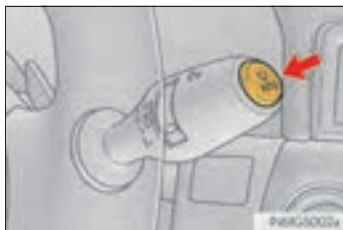

- When the upper part of the windshield where the raindrop sensor is located is touched by hand
- When a wet rag or similar is held close to the raindrop sensor
- If something bumps against the windshield
- If you directly touch the raindrop sensor body or if something bumps into the raindrop sensor

**■ Precautions regarding the exhaust pipes and rear bumper diffusers**

Exhaust gases cause the exhaust pipes and rear bumper diffusers to become quite hot.

When washing the vehicle, be careful not to touch the pipes and diffusers until they have cooled sufficiently, as touching hot exhaust pipes and rear bumper diffusers can cause burns.

 NOTICE

■ **To prevent paint deterioration and corrosion on the body and components (aluminum wheels etc.)**

- Wash the vehicle immediately in the following cases:
  - After driving near the sea coast
  - After driving on salted roads
  - If coal tar or tree sap is present on the paint surface
  - If dead insects, insect droppings or bird droppings are present on the paint surface
  - After driving in an area contaminated with soot, oily smoke, mine dust, iron powder or chemical substances
  - If the vehicle becomes heavily soiled with dust or mud
  - If liquids such as benzene and gasoline are spilled on the paint surface
- If the paint is chipped or scratched, have it repaired immediately.
- To prevent the wheels from corroding, remove any dirt and store in a place with low humidity when storing the wheels.

■ **Cleaning the exterior lights**

- Wash carefully. Do not use organic substances or scrub with a hard brush. This may damage the surfaces of the lights.
- Do not apply wax to the surfaces of the lights. Wax may cause damage to the lenses.

■ **When using an automatic car wash (with rain-sensing windshield wipers)**

Set the wipers to the intermittent windshield wipers. (→P.200)

If AUTO mode is selected, the wipers may operate and the wiper blades may be damaged.

## Cleaning and protecting the vehicle interior

The following procedures will help protect your vehicle's interior and keep it in top condition:

### Protecting the vehicle interior

Remove dirt and dust using a vacuum cleaner. Wipe dirty surfaces with a cloth dampened with lukewarm water.

### Cleaning the leather areas

- Remove dirt and dust using a vacuum cleaner.
- Wipe off any excess dirt and dust with a soft cloth dampened with diluted detergent.  
Use a diluted water solution of approximately 5% neutral wool detergent.
- Wring out any excess water from the cloth and thoroughly wipe off all remaining traces of detergent.
- Wipe the surface with a dry, soft cloth to remove any remaining moisture. Allow the leather to dry in a shaded and ventilated area.

### Cleaning the synthetic leather areas

- Remove loose dirt using a vacuum cleaner.
- Apply a mild soap solution to the synthetic leather using a sponge or soft cloth.
- Allow the solution to soak in for a few minutes. Remove the dirt and wipe off the solution with a clean, damp cloth.

### ■ Caring for leather areas

Lexus recommends cleaning the interior of the vehicle at least twice a year to maintain the quality of the vehicle's interior.

### ■ Shampooing the carpets

There are several commercial foaming-type cleaners available. Use a sponge or brush to apply the foam. Rub in overlapping circles. Do not use water. Wipe dirty surfaces and let them dry. Excellent results are obtained by keeping the carpet as dry as possible.

### ■ Seat belts

Clean with mild soap and lukewarm water using a cloth or sponge. Also check the belts periodically for excessive wear, fraying or cuts.

### ■ When cleaning the carpeted portions of the glove box, console box, etc.

If a strong adhesive tape is used, there is a possibility that the surface of the carpet could be damaged.



## CAUTION

### ■ Water in the vehicle

- Do not splash or spill liquid in the vehicle.

Doing so may cause electrical components etc. to malfunction or catch fire.

- Do not get any of the SRS components or wiring in the vehicle interior wet. (→P. 38)

An electrical malfunction may cause the airbags to deploy or not function properly, resulting in death or serious injury.

### ■ Cleaning the interior (especially instrument panel)

Do not use polish wax or polish cleaner. The instrument panel may reflect off the windshield, obstructing the driver's view and leading to an accident, resulting in death or serious injury.

 NOTICE**■ Cleaning detergents**

- Do not use the following types of detergent, as they may discolor the vehicle interior or cause streaks or damage to painted surfaces:
  - Non-seat portions: Organic substances such as benzene or gasoline, alkaline or acidic solutions, dye, and bleach
  - Seats: Alkaline or acidic solutions, such as thinner, benzene, and alcohol
- Do not use polish wax or polish cleaner. The instrument panel's or other interior part's painted surface may be damaged.

**■ Preventing damage to leather surfaces**

Observe the following precautions to avoid damage to and deterioration of leather surfaces:

- Remove any dust or dirt from leather surfaces immediately.
- Do not expose the vehicle to direct sunlight for extended periods of time. Park the vehicle in the shade, especially during summer.
- Do not place items made of vinyl, plastic, or containing wax on the upholstery, as they may stick to the leather surface if the vehicle interior heats up significantly.

**■ Water on the floor**

Do not wash the vehicle floor with water.

Vehicle systems such as the audio system may be damaged if water comes into contact with electrical components such as the audio system above or under the floor of the vehicle. Water may also cause the body to rust.

**■ When cleaning the inside of the windshield (vehicles with LKA [Lane-Keeping Assist])**

Be careful not to touch the camera sensor (→P. 236).

If the camera is accidentally scratched or hit, LKA may not operate properly or may cause a malfunction.

**■ Cleaning the inside of the rear window**

- Do not use glass cleaner to clean the rear window, as this may cause damage to the rear window defogger heater wires or antenna. Use a cloth dampened with lukewarm water to gently wipe the window clean. Wipe the window in strokes running parallel to the heater wires or antenna.
- Be careful not to scratch or damage the heater wires or antenna.

## Maintenance requirements

To ensure safe and economical driving, day-to-day care and regular maintenance are essential. It is the owner's responsibility to perform regular checks. Lexus recommends performing the following maintenance:

### General maintenance

General maintenance should be performed on a daily basis. This can be done by yourself or by a Lexus dealer.

### Scheduled maintenance

Scheduled maintenance should be performed at specified intervals according to the maintenance schedule.

For details about maintenance items and schedules, refer to the "Warranty and Service Guide", "Owner's Manual Supplement" or "Scheduled Maintenance".

### Do-it-yourself maintenance

You can perform some maintenance procedures by yourself.

Please be aware that do-it-yourself maintenance may affect warranty coverage.

The use of Lexus repair manuals is recommended.

For details about warranty coverage, refer to the separate "Owner's Guide", "Warranty and Service Guide", "Owner's Manual Supplement" or "Warranty Booklet".

### ■ Repair and replacement

It is recommended that genuine Lexus parts be used for repairs to ensure performance of each system. If non-Lexus parts are used in replacement or if a repair shop other than a Lexus dealer performs repairs, confirm the warranty coverage.

### ■ Reset the maintenance data (U.S.A. only)

After the required maintenance is performed according to the maintenance schedule, please reset the maintenance data.

To reset the data, follow the procedure described below:

- 1 Switch the display to the trip meter "A" (→P. 80) when the engine is running.
- 2 Turn the engine switch off.
- 3 While pressing the "ODO TRIP" button (→P. 80), turn the engine switch to the IGNITION ON mode (do not start the engine because otherwise the reset mode will be canceled).

The message shown in the illustration will appear on the display.

Continue to press and hold the button until the trip meter displays "000000".

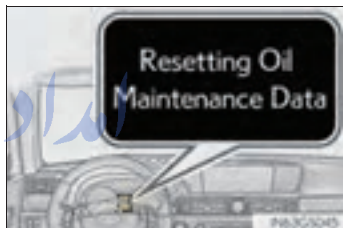

### ■ Allow inspection and repairs to be performed by a Lexus dealer

- Lexus technicians are well-trained specialists and are kept up to date with the latest service information. They are well informed about the operations of all systems on your vehicle.
- Keep a copy of the repair order. It proves that the maintenance that has been performed is under warranty coverage. If any problem should arise while your vehicle is under warranty, your Lexus dealer will promptly take care of it.

تلفن شبانه روزی: ۰۲۱-۸۸۶۲۰۸۵

Forma500.com



 CAUTION**■ If your vehicle is not properly maintained**

Improper maintenance could result in serious damage to the vehicle and possible death or serious injury.

**■ Handling of the battery**

- Engine exhaust, some of its constituents, and a wide variety of automobile components contain or emit chemicals known to the State of California to cause cancer and birth defects and other reproductive harm. Work in a well ventilated area.
- Oils, fuels and fluids contained in vehicles as well as waste produced by component wear contain or emit chemicals known to the State of California to cause cancer and birth defects or other reproductive harm. Avoid exposure and wash any affected area immediately.
- Battery posts, terminals and related accessories contain lead and lead compounds which are known to cause brain damage. Wash your hands after handling. (→P. 624)

امداد خودرو فارما

تلفن شبانه روزی: ۰۲۱-۸۸۶۲۰۸۵

FarmaSOS.com

## General maintenance

Listed below are the general maintenance items that should be performed at the intervals specified in the “Warranty and Service Guide” or “Owner’s Manual Supplement”. It is recommended that any problem you notice should be brought to the attention of your Lexus dealer or qualified service shop for advice.

### Engine compartment

Items	Check points
Battery	Check the battery fluid level and connections. (→P. 624)
Brake fluid	Is the brake fluid at the correct level? (→P. 623)
Engine coolant	Is the engine coolant at the correct level? (→P. 620)
Engine oil	Is the engine oil at the correct level? (→P. 617)
Exhaust system	There should not be any fumes or strange sounds.
Radiator/condenser	The radiator and condenser should be free from foreign objects. (→P. 622)
Washer fluid	Is there sufficient washer fluid? (→P. 628)

## Vehicle interior

Items	Check points
Accelerator pedal	<ul style="list-style-type: none"> <li>The accelerator pedal should move smoothly (without uneven pedal effort or catching).</li> </ul>
Automatic transmission "Park" mechanism	<ul style="list-style-type: none"> <li>When parked on a slope and the shift lever is in P, is the vehicle securely stopped?</li> </ul>
Brake pedal	<ul style="list-style-type: none"> <li>Does the brake pedal move smoothly?</li> <li>Does the brake pedal have appropriate clearance from the floor? (→P.758)</li> <li>Does the brake pedal have the correct amount of free play? (→P.758)</li> </ul>
Brakes	<ul style="list-style-type: none"> <li>The vehicle should not pull to one side when the brakes are applied.</li> <li>The brakes should work effectively.</li> <li>The brake pedal should not feel spongy. تلفن شيبا: ۰۲۱-۸۸۶۲۰۸۵</li> <li>The brake pedal should not get too close to the floor when the brakes are applied.</li> </ul>

Items	Check points
Head restraints	<ul style="list-style-type: none"> <li>• Do the head restraints move smoothly and lock securely?</li> </ul>
Indicators/buzzers	<ul style="list-style-type: none"> <li>• Do the indicators and buzzers function properly?</li> </ul>
Lights	<ul style="list-style-type: none"> <li>• Do all the lights come on?</li> <li>• Are the headlights aimed correctly? (→P. 661)</li> </ul>
Parking brake	<ul style="list-style-type: none"> <li>• Moves smoothly?</li> <li>• When parked on a slope and the parking brake is on, is the vehicle securely stopped?</li> </ul>
Seat belts	<ul style="list-style-type: none"> <li>• Do the seat belts operate smoothly?</li> <li>• The seat belts should not be damaged.</li> </ul>
Seats	<ul style="list-style-type: none"> <li>• Do the seat controls operate properly?</li> </ul>
Steering wheel	<ul style="list-style-type: none"> <li>• Does the steering wheel rotate smoothly?</li> <li>• Does the steering wheel have the correct amount of free play?</li> <li>• There should not be any strange sounds coming from the steering wheel.</li> </ul>

## Vehicle exterior

Items	Check points
Doors/trunk	<ul style="list-style-type: none"> <li>Do the doors/trunk operate smoothly?</li> </ul>
Engine hood	<ul style="list-style-type: none"> <li>Does the engine hood lock system work properly?</li> </ul>
Fluid leaks	<ul style="list-style-type: none"> <li>There should not be any signs of fluid leakage after the vehicle has been parked.</li> </ul>
Tires	<ul style="list-style-type: none"> <li>Is the tire inflation pressure correct?</li> <li>The tires should not be damaged or excessively worn.</li> <li>Have the tires been rotated according to the maintenance schedule?</li> <li>The wheel nuts should not be loose.</li> </ul>

### CAUTION

#### If the engine is running

Turn the engine off and ensure that there is adequate ventilation before performing maintenance checks.

FarmaSOS.com

## Emission inspection and maintenance (I/M) programs

Some states have vehicle emission inspection programs which include OBD (On Board Diagnostics) checks. The OBD system monitors the operation of the emission control system.

### If the malfunction indicator lamp comes on

The OBD system determines that a problem exists somewhere in the emission control system. Your vehicle may not pass the I/M test and may need to be repaired. Contact your Lexus dealer to service the vehicle.

### Your vehicle may not pass the I/M test in the following situations:

- When the battery is disconnected or discharged  
Readiness codes that are set during ordinary driving are erased. Also, depending on your driving habits, the readiness codes may not be completely set. تلفن شبانه روزی: ۰۲۱-۸۸۶۲۰۸۵
- When the fuel tank cap is loose  
The malfunction indicator lamp comes on indicating a temporary malfunction and your vehicle may not pass the I/M test.

### When the malfunction indicator lamp still remains on after several driving trips

The error code in the OBD system will not be cleared unless the vehicle is driven 40 or more times.

### If your vehicle does not pass the I/M test

Contact your Lexus dealer to prepare the vehicle for re-testing.

## Do-it-yourself service precautions

If you perform maintenance by yourself, be sure to follow the correct procedure as given in these sections.

Items	Parts and tools
Battery condition (→P. 624)	<ul style="list-style-type: none"> <li>• Warm water</li> <li>• Baking soda</li> <li>• Grease</li> <li>• Conventional wrench (for terminal clamp bolts)</li> <li>• Distilled water</li> </ul>
Brake fluid level (→P. 623)	<ul style="list-style-type: none"> <li>• FMVSS No.116 DOT 3 or SAE J1703 brake fluid</li> <li>• Rag or paper towel</li> <li>• Funnel (used only for adding brake fluid)</li> </ul>
Engine coolant level (→P. 620)	<ul style="list-style-type: none"> <li>• "Toyota Super Long Life Coolant" or a similar high quality ethylene glycol-based non-silicate, non-amine, non-nitrite and non-borate coolant with long-life hybrid organic acid technology</li> <li>For the U.S.A.: "Toyota Super Long Life Coolant" is pre-mixed with 50% coolant and 50% deionized water.</li> <li>For Canada: "Toyota Super Long Life Coolant" is pre-mixed with 55% coolant and 45% deionized water.</li> <li>• Funnel (used only for adding coolant)</li> </ul>
Engine oil level (→P. 617)	<ul style="list-style-type: none"> <li>• "Toyota Genuine Motor Oil" or equivalent</li> <li>• Rag or paper towel</li> <li>• Funnel (used only for adding engine oil)</li> </ul>
Fuses (→P. 648)	<ul style="list-style-type: none"> <li>• Fuse with same amperage rating as original</li> </ul>

Items	Parts and tools
Headlight aim (→P. 661)	• Phillips-head screwdriver
Light bulbs (→P. 663)	<ul style="list-style-type: none"> <li>• Bulb with same number and wattage rating as original</li> <li>• Phillips-head screwdriver</li> <li>• Flathead screwdriver</li> <li>• Wrench</li> </ul>
Radiator and condenser (→P. 622)	—
Tire inflation pressure (→P. 639)	<ul style="list-style-type: none"> <li>• Tire pressure gauge</li> <li>• Compressed air source</li> </ul>
Washer fluid (→P. 628)	<ul style="list-style-type: none"> <li>• Water or washer fluid containing anti-freeze (for winter use)</li> <li>• Funnel (used only for adding water or washer fluid)</li> </ul>

امداد خودرو فارما

تلفن شبانه روزی: ۰۲۱-۸۸۶۲۰۸۵

FarmaSOS.com



 CAUTION

The engine compartment contains many mechanisms and fluids that may move suddenly, become hot, or become electrically energized. To avoid death or serious injury, observe the following precautions.

■ **When working on the engine compartment**

- Keep hands, clothing and tools away from the moving fan and engine drive belt.
- Be careful not to touch the engine, radiator, exhaust manifold, etc. right after driving as they may be hot. Oil and other fluids may also be hot.
- Do not leave anything that may burn easily, such as paper and rags, in the engine compartment.
- Do not smoke, cause sparks or expose an open flame to fuel or the battery. Fuel and battery fumes are flammable.
- Be extremely cautious when working on the battery. It contains poisonous and corrosive sulfuric acid.

■ **When working near the electric cooling fans or radiator grille**

Be sure the engine switch is off.

With the engine switch in IGNITION ON mode, the electric cooling fans may automatically start to run if the air conditioning is on and/or the coolant temperature is high. (→P. 622)

■ **Safety glasses**

Wear safety glasses to prevent flying or falling material, fluid spray, etc. from getting in your eyes.

تلفن شبانه روزی: ۰۲۱-۸۸۶۲۰۸۵  
FarmaSOS.com

 NOTICE

■ **If you remove the air cleaner filter**

Driving with the air cleaner filter removed may cause excessive engine wear due to dirt in the air. Also, a backfire could cause a fire in the engine compartment.

## Hood

Release the lock from the inside of the vehicle to open the hood.

- 1 Pull the hood lock release lever.

The hood will pop up slightly.



- 2 Pull up the auxiliary catch lever and lift the hood.

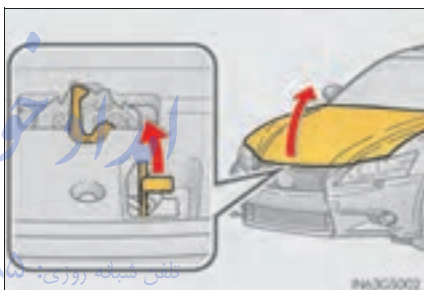

### ⚠ CAUTION

#### ■ Pre-driving check

Check that the hood is fully closed and locked.

If the hood is not locked properly, it may open while the vehicle is in motion and cause an accident, which may result in death or serious injury.

## Positioning a floor jack

When raising your vehicle with a floor jack, position the jack correctly. Improper placement may damage your vehicle or cause injury.

### ◆ Front

#### ▶ 2WD models



#### ▶ AWD models



### ◆ Rear

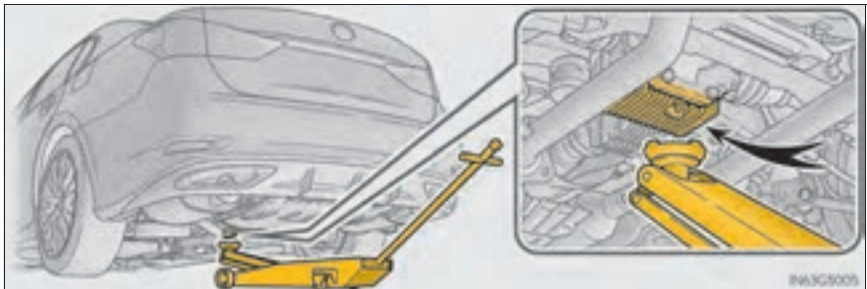

## ⚠ CAUTION

### ■ When raising your vehicle

Make sure to observe the following precautions to reduce the possibility of death or serious injury:

- Lift up the vehicle using a floor jack such as the one shown in the illustration.

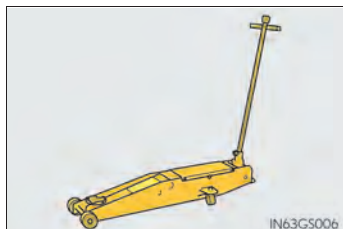

- When using a floor jack, follow the instructions of the manual provided with the jack.
- Do not use the jack that was supplied with your vehicle.
- Do not put any part of your body underneath the vehicle when it is supported only by the floor jack.
- Always use floor jack and/or automotive jack stands on a solid, flat, level surface.
- Do not start the engine while the vehicle is supported by the floor jack.
- Stop the vehicle on level, firm ground, firmly set the parking brake and shift the shift lever to P.
- Make sure to set the floor jack properly at the jack point.  
Raising the vehicle with an improperly positioned floor jack will damage the vehicle and may cause the vehicle to fall off the floor jack.
- Do not raise the vehicle while someone is in the vehicle.
- When raising the vehicle, do not place any object on top of or underneath the floor jack.

## Engine compartment

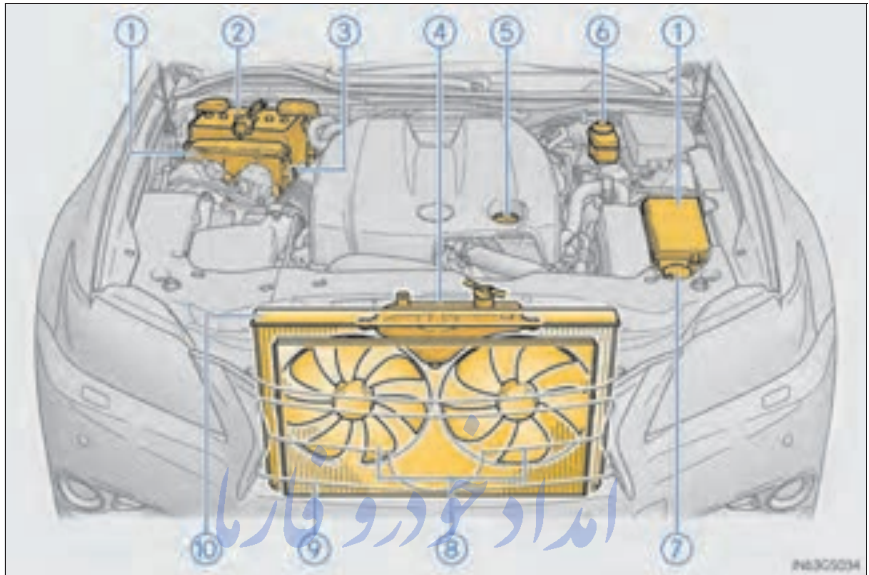

- |                             |           |                         |           |
|-----------------------------|-----------|-------------------------|-----------|
| ① Fuse boxes                | (→P. 648) | ⑥ Brake fluid reservoir | (→P. 623) |
| ② Battery                   | (→P. 624) | ⑦ Washer fluid tank     | (→P. 628) |
| ③ Engine oil level dipstick | (→P. 617) | ⑧ Electric cooling fans | (→P. 622) |
| ④ Engine coolant reservoir  | (→P. 620) | ⑨ Condenser             | (→P. 622) |
| ⑤ Engine oil filler cap     | (→P. 618) | ⑩ Radiator              | (→P. 622) |

## Engine compartment cover

### ■ Removing the engine compartment cover

- ▶ Right-hand side

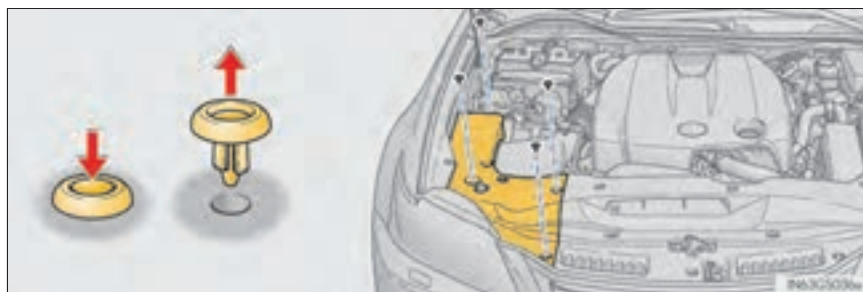

- ▶ Center



### ■ Installing the clips [FarmaSOS.com](http://FarmaSOS.com)

- ① Push up center portion
- ② Insert
- ③ Press



### ⚠ NOTICE

#### ■ Checking the engine compartment cover after installation

Make sure that the cover is securely installed in its original position.

## Engine oil

With the engine at operating temperature and turned off, check the oil level on the dipstick.

### ■ Checking the engine oil

- 1 Park the vehicle on level ground. After warming up the engine and turning it off, wait more than 5 minutes for the oil to drain back into the bottom of the engine.
- 2 Holding a rag under the end, pull the dipstick out.

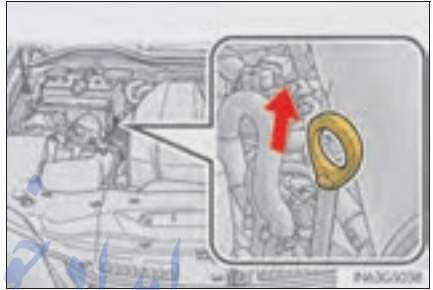

- 3 Wipe the dipstick clean.
- 4 Reinsert the dipstick fully.
- 5 Holding a rag under the end, pull the dipstick out and check the oil level.
  - 1 Low
  - 2 Full

#### ► Type A

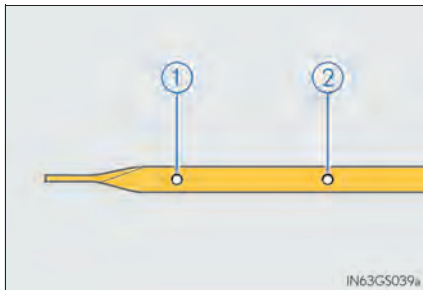

#### ► Type B

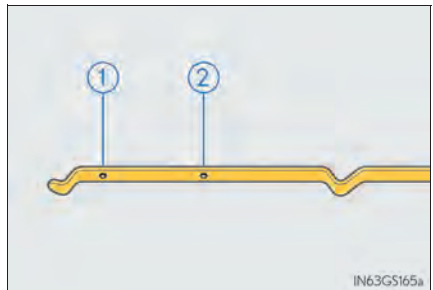

- 6 Wipe the dipstick and reinsert it fully.

### ■ Adding engine oil

If the oil level is below or near the low level mark, add engine oil of the same type as that already in the engine.

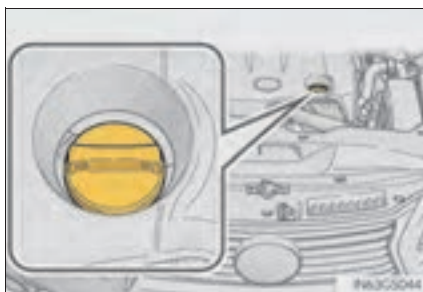

Make sure to check the oil type and prepare the items needed before adding oil.

Engine oil selection	→P. 755
Oil quantity (Low → Full)	1.6 qt. (1.5 L, 1.3 Imp.qt.)
Items	Clean funnel

- 1 Remove the oil filler cap by turning it counterclockwise.
- 2 Add engine oil slowly, checking the dipstick.
- 3 Install the oil filler cap by turning it clockwise.

### ■ Engine oil consumption

A considerable amount of engine oil will be consumed while driving. In the following situations, oil consumption may increase, and engine oil may need to be refilled in between oil maintenance intervals.

- When the engine is new, for example directly after purchasing the vehicle or after replacing the engine
- If low quality oil or oil of an inappropriate viscosity is used
- When driving at high engine speeds or with a heavy load, when driving while accelerating or decelerating frequently
- When leaving the engine idling for a long time, or when driving frequently through heavy traffic
- When judging the amount of oil consumption, keep in mind that the oil may have become diluted, making it difficult to judge the true level accurately.



 CAUTION

**■ Used engine oil**

- Used engine oil contains potentially harmful contaminants which may cause skin disorders such as inflammation and skin cancer, so care should be taken to avoid prolonged and repeated contact. To remove used engine oil from your skin, wash thoroughly with soap and water.
- Dispose of used oil and filters only in a safe and acceptable manner. Do not dispose of used oil and filters in household trash, in sewers or onto the ground. Call your Lexus dealer, service station or auto parts store for information concerning recycling or disposal.
- Do not leave used engine oil within the reach of children.

 NOTICE

**■ To prevent serious engine damage**

Check the oil level on a regular basis.

**■ When replacing the engine oil**

- Be careful not to spill engine oil on the vehicle components.
- Avoid overfilling, or the engine could be damaged.
- Check the oil level on the dipstick every time you refill the vehicle.
- Be sure the engine oil filler cap is properly tightened.

## Engine coolant

The coolant level is satisfactory if it is between the “FULL” and “LOW” lines on the reservoir when the engine is cold.

- ① Reservoir cap
- ② “FULL” line
- ③ “LOW” line

If the level is on or below the “LOW” line, add coolant up to the “FULL” line.  
(→P. 747)

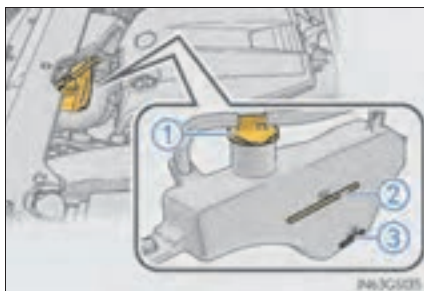

### ■ Coolant selection

Only use “Toyota Super Long Life Coolant” or a similar high quality ethylene glycol based non-silicate, non-amine, non-nitrite, and non-borate coolant with long-life hybrid organic acid technology.

U.S.A.:

“Toyota Super Long Life Coolant” is a mixture of 50% coolant and 50% deionized water. (Minimum temperature: -31°F [-35°C])

Canada:

“Toyota Super Long Life Coolant” is a mixture of 55% coolant and 45% deionized water. (Minimum temperature: -44°F [-42°C])

For more details about engine coolant, contact your Lexus dealer.

### ■ If the coolant level drops within a short time of replenishing

Visually check the radiator, hoses, engine coolant reservoir caps, drain cock and water pump.

If you cannot find a leak, have your Lexus dealer test the cap and check for leaks in the cooling system.

 CAUTION**■ When the engine is hot**

Do not remove the engine coolant reservoir cap or the radiator cap. (→P. 748)  
The cooling system may be under pressure and may spray hot coolant if the cap is removed, causing serious injuries, such as burns.

 NOTICE**■ When adding coolant**

Coolant is neither plain water nor straight antifreeze. The correct mixture of water and antifreeze must be used to provide proper lubrication, corrosion protection and cooling. Be sure to read the antifreeze or coolant label.

**■ If you spill coolant**

Be sure to wash it off with water to prevent it from damaging parts or paint.

امداد خودرو فارما

تلفن شبانه روزی: ۰۲۱-۸۸۶۲۰۸۵

FarmaSOS.com

## Radiator and condenser

Check the radiator and condenser and clear away any foreign objects. If either of the above parts is extremely dirty or you are not sure of their condition, have your vehicle inspected by your Lexus dealer.

### CAUTION

#### ■ When the engine is hot

Do not touch the radiator or condenser as they may be hot and cause serious injuries, such as burns.

امداد خودرو فارما

تلفن شبانه روزی: ۰۲۱-۸۸۶۲۰۸۵

FarmaSOS.com

## Brake fluid

### ■ Checking fluid level

The brake fluid level should be between the “MAX” and “MIN” lines on the tank.

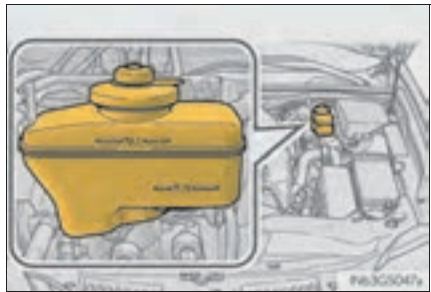

### ■ Adding fluid

Make sure to check the fluid type and prepare the necessary item.

Fluid type	FMVSS No.116 DOT 3 or SAE J1703 brake fluid
Items	Clean funnel

### ■ Brake fluid can absorb moisture from the air

Excess moisture in the brake fluid can cause a dangerous loss of braking efficiency. Use only newly opened brake fluid.

### ⚠ CAUTION

#### ■ When filling the reservoir

Take care as brake fluid can harm your hands and eyes and damage painted surfaces.

If fluid gets on your hands or in your eyes, flush the affected area with clean water immediately.

If you still experience discomfort, see a doctor.

### ⚠ NOTICE

#### ■ If the fluid level is low or high

It is normal for the brake fluid level to go down slightly as the brake pads wear out or when the fluid level in the accumulator is high.

If the reservoir needs frequent refilling, there may be a serious problem.

## Battery

Check the battery as follows.

### ■ Battery exterior

Make sure that the battery terminals are not corroded and that there are no loose connections, cracks, or loose clamps.

- ① Terminals
- ② Hold-down clamp



### ■ Checking battery fluid

Check that the level is between the "UPPER LEVEL" and "LOWER LEVEL" lines.

- ① "UPPER LEVEL" line
- ② "LOWER LEVEL" line

If the fluid level is at or below the "LOWER LEVEL" line, add distilled water.



### ■ Adding distilled water

- 1 Remove the vent plug.
- 2 Add distilled water.

If the "UPPER LEVEL" line cannot be seen, check the fluid level by looking directly at the cell.

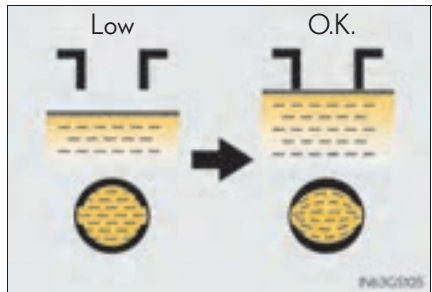

- 3 Put the vent plug back on and close it securely.

### ■ Before recharging

When recharging, the battery produces hydrogen gas which is flammable and explosive. Therefore, observe the following before recharging:

- If recharging with the battery installed on the vehicle, be sure to disconnect the ground cable.
- Make sure the power switch on the charger is off when connecting and disconnecting the charger cables to the battery.

FarmaSOS.com

### ■ After recharging/reconnecting the battery

The engine may not start. Follow the procedure below to initialize the system.

- 1 Shift the shift lever to P.
- 2 Open and close any of the doors.
- 3 Restart the engine.
  - Unlocking the doors using the smart access system with push-button start may not be possible immediately after reconnecting the battery. If this happens, use the wireless remote control or the mechanical key to lock/unlock the doors.
  - Start the engine with the engine switch in ACCESSORY mode. The engine may not start with the engine switch turned off. However, the engine will operate normally from the second attempt.
  - The engine switch mode is recorded by the vehicle. If the battery is reconnected, the vehicle will return the engine switch mode to the status it was in before the battery was disconnected. Make sure to turn off the engine before disconnect the battery. Take extra care when connecting the battery if the engine switch mode prior to discharge is unknown.

If the system will not start even after multiple attempts, contact your Lexus dealer.

### ⚠ CAUTION

#### ■ Chemicals in the battery

Batteries contain poisonous and corrosive sulfuric acid and may produce hydrogen gas which is flammable and explosive. To reduce the risk of death or serious injury, take the following precautions while working on or near the battery:

- Do not cause sparks by touching the battery terminals with tools.
- Do not smoke or light a match near the battery.
- Avoid contact with eyes, skin and clothes.
- Never inhale or swallow electrolyte.
- Wear protective safety glasses when working near the battery.
- Keep children away from the battery.



 CAUTION

**■ Where to safely charge the battery**

Always charge the battery in an open area. Do not charge the battery in a garage or closed room where there is insufficient ventilation.

**■ Emergency measures regarding electrolyte**

- If electrolyte gets in your eyes  
Flush your eyes with clean water for at least 15 minutes and get immediate medical attention. If possible, continue to apply water with a sponge or cloth while traveling to the nearest medical facility.
- If electrolyte gets on your skin  
Wash the affected area thoroughly. If you feel pain or burning, get medical attention immediately.
- If electrolyte gets on your clothes  
It can soak through clothing on to your skin. Immediately take off the clothing and follow the procedure above if necessary.
- If you accidentally swallow electrolyte  
Drink a large quantity of water or milk. Get emergency medical attention immediately.

 NOTICE

تلفن شبانه روزی: ۰۲۱-۸۸۶۲۰۸۵

**■ When recharging the battery**

Never recharge the battery while the engine is operating. Also, be sure all accessories are turned off.

**■ When adding distilled water**

Avoid overfilling. Water spilled during battery recharging may cause corrosion.

## Washer fluid

If any washer does not work or the warning message appears on the multi-information display, the washer tank may be empty. Add washer fluid.



### CAUTION

#### ■ When adding washer fluid

Do not add washer fluid when the engine is hot or running as washer fluid contains alcohol and may catch fire if spilled on the engine etc.

### NOTICE

#### ■ Do not use any fluid other than washer fluid

Do not use soapy water or engine antifreeze instead of washer fluid. Doing so may cause streaking on the vehicle's painted surfaces.

#### ■ Diluting washer fluid

Dilute washer fluid with water as necessary.  
Refer to the freezing temperatures listed on the label of the washer fluid bottle.

## Tires

Replace or rotate tires in accordance with maintenance schedules and treadwear.

### Checking tires

- ① New tread
- ② Treadwear indicator
- ③ Worn tread

The location of treadwear indicators is shown by the “TWI” or “Δ” marks, etc., molded on the sidewall of each tire.

Check spare tire condition and pressure if not rotated.

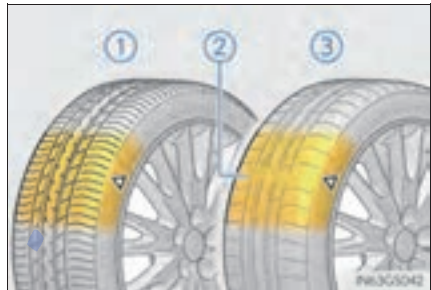

تلفن شبانه روزی: ۰۲۱-۸۸۶۲۰۸۵

FarmaSOS.com

## Tire rotation

- ▶ Vehicles with front and rear tires of the same size

Rotate the tires in the order shown.

To equalize tire wear and extend tire life, Lexus recommends that tire rotation is carried out at the same interval as tire inspection.

Do not fail to initialize the tire pressure warning system after tire rotation.

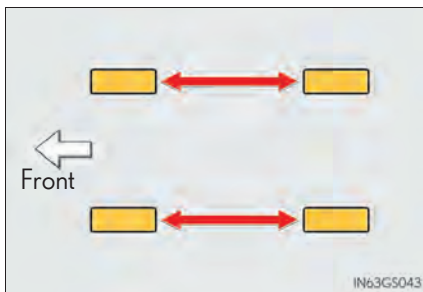

- ▶ Vehicles with front and rear tires of differing sizes

Tires cannot be rotated.

امداد خودرو فارما

تلفن شبانه روزی: ۰۲۱-۸۸۶۲۰۸۵

FarmaSOS.com

## Tire pressure warning system

Your vehicle is equipped with a tire pressure warning system that uses tire pressure warning valves and transmitters to detect low tire inflation pressure before serious problems arise.

- ▶ Vehicles without the tire inflation pressure display function

If the tire pressure drops below a predetermined level, the driver is warned by a warning light. (→P. 690)

- ▶ Vehicles with the tire inflation pressure display function

- If the tire pressure drops below a predetermined level, the driver is warned by a screen display and a warning light. (→P. 713)
- The tire pressure detected by the tire pressure warning system can be displayed on the multi-information display. (→P. 85)

### ◆ Installing tire pressure warning valves and transmitters

When replacing tires or wheels, tire pressure warning valves and transmitters must also be installed.

When new tire pressure warning valves and transmitters are installed, new ID codes must be registered in the tire pressure warning computer and the tire pressure warning system must be initialized. Have tire pressure warning valve and transmitter ID codes registered by your Lexus dealer. (→P. 633)

### ◆ Initializing the tire pressure warning system

- **The tire pressure warning system must be initialized in the following circumstances:**
  - When rotating the tires.
  - When the tire inflation pressure is changed such as when changing traveling speed or load weight.

When the tire pressure warning system is initialized, the current tire inflation pressure is set as the benchmark pressure.

### ■ How to initialize the tire pressure warning system

- 1 Park the vehicle in a safe place and turn the engine switch off.

Initialization cannot be performed while the vehicle is moving.

- 2 Adjust the tire inflation pressure to the specified cold tire inflation pressure level. (→P. 759)

Make sure to adjust the tire pressure to the specified cold tire inflation pressure level. The tire pressure warning system will operate based on this pressure level.

- 3 Turn the engine switch to IGNITION ON mode.

- 4 Press and hold the tire pressure warning reset switch until the tire pressure warning light blinks slowly 3 times.



- 5 Wait for a few minutes with the engine switch in IGNITION ON mode and then turn the engine switch off.

## ◆ Registering ID codes

The tire pressure warning valve and transmitter is equipped with a unique ID code. When replacing a tire pressure warning valve and transmitter, it is necessary to register the ID code. Have the ID code registered by your Lexus dealer.

### ■ When to replace your vehicle's tires

Tires should be replaced if:

- You have tire damage such as cuts, splits, cracks deep enough to expose the fabric, and bulges indicating internal damage
- A tire goes flat repeatedly or cannot be properly repaired due to the size or location of a cut or other damage

If you are not sure, consult with your Lexus dealer.

### ■ Replacing tires and wheels

If the ID code of the tire pressure warning valve and transmitter is not registered, the tire pressure warning system will not work properly. After driving for about 20 minutes, the tire pressure warning light blinks for 1 minute and stays on to indicate a system malfunction.

### ■ Tire life

Any tire over 6 years old must be checked by a qualified technician even if it has seldom or never been used or damage is not obvious.

### ■ Routine tire inflation pressure checks

The tire pressure warning system does not replace routine tire inflation pressure checks. Make sure to check tire inflation pressure as part of your routine of daily vehicle checks.

### ■ When rotating the tires (vehicles with the tire inflation pressure display function)

Make sure that the engine switch is off. If the tires are rotated while the engine switch is in IGNITION ON mode, the tire position information will not be updated.

If this accidentally occurs, either turn the engine switch to off and then to IGNITION ON mode, or initialize the system after checking that the tire pressure is properly adjusted.

### ■ Low profile tires (except 225/50R17 tires)

Generally, low profile tires will wear more rapidly and tire grip performance will be reduced on snowy and/or icy roads when compared to standard tires. Be sure to use snow tires or tire chains\* on snowy and/or icy roads and drive carefully at a speed appropriate for road and weather conditions.

\*: Tire chains cannot be used on vehicles with front and rear tires of differing sizes and vehicles equipped with LDH and 19-inch tires. Snow tires should be used instead.

### ■ Maximum load of tire

Check that the maximum load of the replacement tire is greater than 1/2 of the Gross Axle Weight Ratings (GAWR) of either the front axle or the rear axle, whichever is greater.

For the GAWR, see the Certification Label.  
For the maximum load of the tire, see the load limit at maximum cold tire inflation pressure mentioned on the sidewall of the tire.  
(→P. 765)

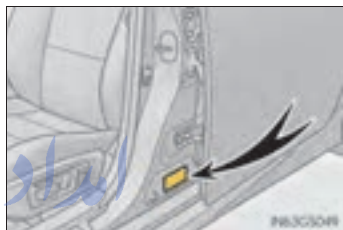

### ■ Tire types

#### ● Summer tires

Summer tires are high-speed performance tires best suited to highway driving under dry conditions. Since summer tires do not have the same traction performance as snow tires, summer tires are inadequate for driving on snow-covered or icy roads. For driving on snow-covered roads or icy roads, the use of snow tires is recommended. When installing snow tires, be sure to replace all four tires.

#### ● All season tires

All season tires are designed to provide better traction in snow and to be adequate for driving in most winter conditions as well as for use year-round. All season tires, however, do not have adequate traction performance compared with snow tires in heavy or loose snow. Also, all season tires fall short in acceleration and handling performance compared with summer tires in highway driving.

#### ● Snow tires

For driving on snow-covered roads or icy roads, we recommend using snow tires. If you need snow tires, select tires of the same size, construction and load capacity as the originally installed tires. Since your vehicle has radial tires as original equipment, make sure your snow tires also have radial construction. Do not install studded tires without first checking local regulations for possible restrictions. Snow tires should be installed on all wheels. (→P. 298)



### ■ If the tread on snow tires wears down below 0.16 in. (4 mm)

The effectiveness of the tires as snow tires is lost.

### ■ Situations in which the tire pressure warning system may not operate properly

- In the following cases, the tire pressure warning system may not operate properly.
  - If non-genuine Lexus wheels are used.
  - A tire has been replaced with a tire that is not an OE (Original Equipment) tire.
  - A tire has been replaced with a tire that is not of the specified size.
  - Tire chains etc. are equipped.
  - Lock nuts are equipped.
  - An auxiliary-supported run-flat tire is equipped.
  - If a window tint that affects the radio wave signals is installed.
  - If there is a lot of snow or ice on the vehicle, particularly around the wheels or wheel housings.
  - If the tire inflation pressure is extremely higher than the specified level.
- Performance may be affected in the following situations.
  - Near a TV tower, electric power plant, gas station, radio station, large display, airport or other facility that generates strong radio waves or electrical noise
  - When carrying a portable radio, cellular phone, cordless phone or other wireless communication device

Vehicles with the tire inflation pressure display function: If tire position information is not correctly displayed due to the radio wave conditions, the display may be corrected by driving and changing the radio wave conditions.

- When the vehicle is parked, the time taken for the warning to start or go off could be extended.
- When tire inflation pressure declines rapidly for example when a tire has burst, the warning may not function.

### ■ The initialization operation

- Make sure to carry out initialization after adjusting the tire inflation pressure. Also, make sure the tires are cold before carrying out initialization or tire inflation pressure adjustment.
- If you have accidentally turned the engine switch off during initialization, it is not necessary to press the reset switch again as initialization will restart automatically when the engine switch has been turned to IGNITION ON mode for the next time.
- If you accidentally press the reset switch when initialization is not necessary, adjust the tire inflation pressure to the specified level when the tires are cold, and conduct initialization again.

### ■ When initialization of the tire pressure warning system has failed

Initialization can be completed in a few minutes. However, in the following cases, the settings have not been recorded and the system will not operate properly. If repeated attempts to record tire inflation pressure settings are unsuccessful, have the vehicle inspected by your Lexus dealer.

- When operating the tire pressure warning reset switch, the tire pressure warning light does not blink 3 times.
- After carrying out the initialization procedure, the tire pressure warning light blinks for 1 minute then stays on after driving for 20 minutes.

### ■ Tire pressure warning system certification

MODEL/FCC IDs:

Transmitter: PAXPMVC010

Initiator: HYQ22AAA

- ▶ For vehicles sold in the U.S.A.

This device complies with Part 15 of the FCC Rules. Operation is subject to the following two conditions: (1) this device may not cause harmful interference, and (2) this device must accept any interference received, including interference that may cause undesired operation.

FCC WARNING:

Changes or modifications not expressly approved by the party responsible for compliance could void the user's authority to operate the equipment.

- ▶ For vehicles sold in Canada

Operation is subject to the following two conditions: (1) this device may not cause interference, and (2) this device must accept any interference, including interference that may cause undesired operation of the device.

## CAUTION

### ■ When inspecting or replacing tires

Observe the following precautions to prevent accidents.

Failure to do so may cause damage to parts of the drive train as well as dangerous handling characteristics, which may lead to an accident resulting in death or serious injury.

- Do not mix tires of different makes, models or tread patterns.  
Also, do not mix tires of remarkably different treadwear.
- Do not use tire sizes other than those recommended by Lexus.
- Do not mix differently constructed tires (radial, bias-belted or bias-ply tires).
- Do not mix summer, all season and snow tires.
- Do not use tires that have been used on another vehicle.  
Do not use tires if you do not know how they were used previously.

### ■ When initializing the tire pressure warning system

Do not operate the tire pressure warning reset switch without first adjusting the tire inflation pressure to the specified level. Otherwise, the tire pressure warning light may not come on even if the tire inflation pressure is low, or it may come on when the tire inflation pressure is actually normal.

### ■ Caution regarding interference with electronic devices (vehicles with the tire inflation pressure display function)

- People with implanted pacemakers or cardiac defibrillators should not come within 17.7 in. (450 mm) of the tire pressure warning system initiators. The radio waves may affect the operation of such devices.



- Users of any electrical medical device other than implanted pacemakers and implanted cardiac defibrillators should consult the manufacturer of the device for information about its operation under the influence of radio waves.  
Radio waves could have unexpected effects on the operation of such medical devices.

 NOTICE**■ Repairing or replacing tires, wheels, tire pressure warning valves, transmitters and tire valve caps**

- When removing or fitting the wheels, tires or the tire pressure warning valves and transmitters, contact your Lexus dealer as the tire pressure warning valves and transmitters may be damaged if not handled correctly.
- Make sure to install the tire valve caps. If the tire valve caps are not installed, water could enter the tire pressure warning valves and the tire pressure warning valves could be bound.
- When replacing tire valve caps, do not use tire valve caps other than those specified. The cap may become stuck.

**■ To avoid damage to the tire pressure warning valves and transmitters**

When a tire is repaired with liquid sealants, the tire pressure warning valve and transmitter may not operate properly. If a liquid sealant is used, contact your Lexus dealer or other qualified service shop as soon as possible. Make sure to replace the tire pressure warning valve and transmitter when replacing the tire. (→P. 631)

**■ Driving on rough roads**

Take particular care when driving on roads with loose surfaces or potholes. These conditions may cause losses in tire inflation pressure, reducing the cushioning ability of the tires. In addition, driving on rough roads may cause damage to the tires themselves, as well as the vehicle's wheels and body.

**■ Low profile tires (except 225/50R17 tires)**

Low profile tires may cause greater damage than usual to the tire wheel when sustaining impact from the road surface. Therefore, pay attention to the following:

- Be sure to use proper tire inflation pressure. If tires are under-inflated, they may be damaged more severely.
- Avoid potholes, uneven pavement, curbs and other road hazards. Failure to do so may lead to severe tire and wheel damage.

**■ If tire inflation pressure of each tire becomes low while driving**

Do not continue driving, or your tires and/or wheels may be ruined.

## Tire inflation pressure

### Tire inflation pressure

The recommended cold tire inflation pressure and tire size are displayed on the tire and loading information label. (→P. 759)



فارما سوس فارما

تلفن شبانه روزی: ۰۲۱-۸۸۶۲۰۸۵

FarmaSOS.com

## Inspection and adjustment procedure

- ① Tire valve
- ② Tire pressure gauge

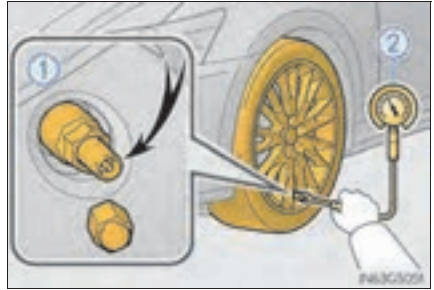

- 1 Remove the tire valve cap.
- 2 Press the tip of the tire pressure gauge onto the tire valve.
- 3 Read the pressure using the gauge gradations.
- 4 If the tire inflation pressure is not at the recommended level, adjust the pressure.  
If you add too much air, press the center of the valve to deflate.
- 5 After completing the tire inflation pressure measurement and adjustment, apply soapy water to the valve and check for leakage.
- 6 Put the tire valve cap back on.

### ■ Tire inflation pressure check interval

You should check tire inflation pressure every two weeks, or at least once a month. Do not forget to check the spare.

### ■ Effects of incorrect tire inflation pressure

Driving with incorrect tire inflation pressure may result in the following:

- Reduced fuel efficiency
- Reduced driving comfort and tire life
- Reduced safety
- Damage to the drive train

If a tire needs frequent inflating, have it checked by your Lexus dealer.

### ■ Instructions for checking tire inflation pressure

When checking tire inflation pressure, observe the following:

- Check only when the tires are cold.  
If your vehicle has been parked for at least 3 hours or has not been driven for more than 1 mile or 1.5 km, you will get an accurate cold tire inflation pressure reading.
- Always use a tire pressure gauge.  
The appearance of the tire can be misleading. In addition, tire inflation pressure that is even just a few pounds off can affect ride quality and handling.
- Do not reduce tire inflation pressure after driving. It is normal for tire inflation pressure to be higher after driving.
- Never exceed the vehicle capacity weight.  
Passengers and luggage weight should be placed so that the vehicle is balanced.

### ⚠ CAUTION

#### ■ Proper inflation is critical to save tire performance

Keep your tires properly inflated. Otherwise, the following conditions may occur and result in an accident causing death or serious injury:

- Excessive wear
- Uneven wear
- Poor handling
- Possibility of blowouts resulting from overheated tires
- Poor sealing of the tire bead
- Wheel deformation and/or tire separation
- A greater possibility of tire damage from road hazards

### ⚠ NOTICE

#### ■ When inspecting and adjusting tire inflation pressure

Be sure to put the tire valve caps back on.

Without the valve caps, dirt or moisture could get into the valve and cause air leakage, which could result in an accident. If the caps are lost, replace them as soon as possible.

## Wheels

If a wheel is bent, cracked or heavily corroded, it should be replaced. Otherwise, the tire may separate from the wheel or cause a loss of handling control.

### Wheel selection

When replacing wheels, care should be taken to ensure that they are equivalent to those removed in load capacity, diameter, rim width and inset\*.

Replacement wheels are available at your Lexus dealer.

\*: Conventionally referred to as "offset".

Lexus does not recommend using the following:

- Wheels of different sizes or types
- Used wheels
- Bent wheels that have been straightened
- Steel wheels (2WD F SPORT models only)

### Aluminum wheel precautions

- Use only Lexus wheel nuts and wrenches designed for use with your aluminum wheels.
- When rotating, repairing or changing your tires, check that the wheel nuts are still tight after driving 1000 miles (1600 km).
- Be careful not to damage the aluminum wheels when using tire chains.
- Use only Lexus genuine balance weights or equivalent and a plastic or rubber hammer when balancing your wheels.



### ■ When replacing wheels

The wheels of your vehicle are equipped with tire pressure warning valves and transmitters that allow the tire pressure warning system to provide advance warning in the event of a loss in tire inflation pressure. Whenever wheels are replaced, tire pressure warning valves and transmitters must be installed. (→P. 631)

### CAUTION

#### ■ When replacing wheels

- Do not use wheels that are a different size from those recommended in the Owner's Manual, as this may result in a loss of handling control.
- Never use an inner tube in a leaking wheel which is designed for a tubeless tire. Doing so may result in an accident, causing death or serious injury.
- 2WD F SPORT models: Do not install steel wheels.  
The wheel contact surface could be damaged, and the wheel could come off while driving, which could lead to an accident resulting in death or serious injury.

### NOTICE

#### ■ Replacing tire pressure warning valves and transmitters

- Because tire repair or replacement may affect the tire pressure warning valves and transmitters, make sure to have tires serviced by your Lexus dealer or other qualified service shop. In addition, make sure to purchase your tire pressure warning valves and transmitters at your Lexus dealer.
- Ensure that only genuine Lexus wheels are used on your vehicle.  
Tire pressure warning valves and transmitters may not work properly with non-genuine wheels.

## Air conditioning filter

The air conditioning filter must be changed regularly to maintain air conditioning efficiency.

### Removal method

- 1 Turn the engine switch off.
- 2 Open the glove box. Lift up the side with the stay, disconnect the stay tabs and remove the partition by pulling horizontally.
- 3 Press the tabs and remove the filter cover.
- 4 Press the tabs and remove the filter case.

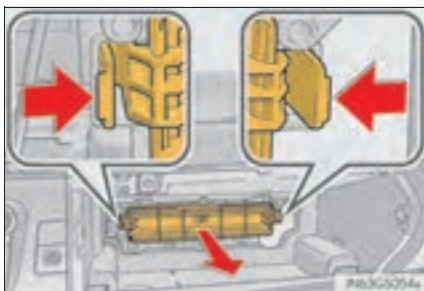
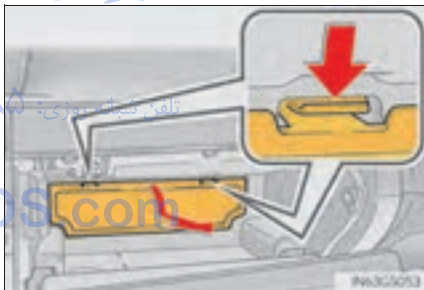
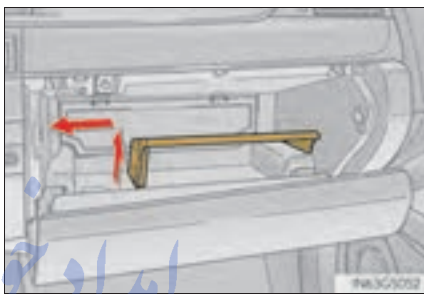

- 5** Remove the air conditioning filter from the filter case and replace it with a new one.

The “↑UP” marks shown on the filter and the filter case should be pointing up.

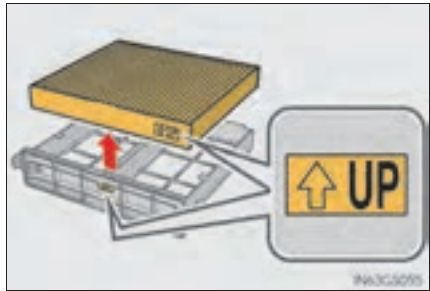

### ■ Checking interval

Inspect and replace the air conditioning filter according to the maintenance schedule. In dusty areas or areas with heavy traffic flow, early replacement may be required. (For scheduled maintenance information, please refer to the “Owner’s Manual Supplement” or “Scheduled Maintenance”.)

### ■ If air flow from the vents decreases dramatically

The filter may be clogged. Check the filter and replace if necessary.

#### NOTICE

#### ■ When using the air conditioning system

Make sure that a filter is always installed.  
Using the air conditioning system without a filter may cause damage to the system.

FarmaSOS.com

## Electronic key battery

Replace the battery with a new one if it is depleted.

You will need the following items:

- Flathead screwdriver
- Small flathead screwdriver
- Lithium battery CR2032

### Replacing the battery

- 1 Take out the mechanical key.



- 2 Remove the cover.

To prevent damage to the key, cover the tip of the screwdriver with a rag.

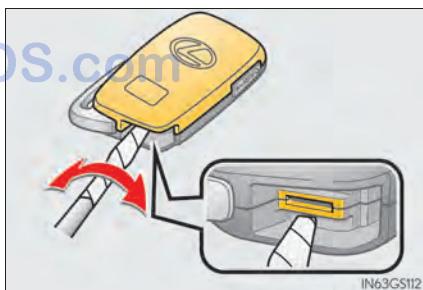

- 3 Remove the depleted battery.

Insert a new battery with the "+" terminal facing up.

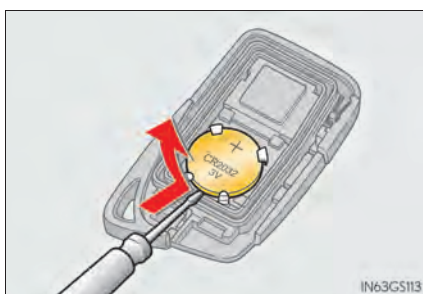

### ■ Use a CR2032 lithium battery

- Batteries can be purchased at your Lexus dealer, local electrical appliance shops or camera stores.
- Replace only with the same or equivalent type recommended by the manufacturer.
- Dispose of used batteries according to local laws.

### ■ If the electronic key battery is depleted

The following symptoms may occur:

- The smart access system with push-button start and wireless remote control will not function properly.
- The operational range will be reduced.

### CAUTION

#### ■ Removed battery and other parts

Keep away from children. These parts are small and if swallowed by a child, they can cause choking. Failure to do so could result in death or serious injury.

### NOTICE

#### ■ For normal operation after replacing the battery

Observe the following precautions to prevent accidents:

- Always work with dry hands.  
Moisture may cause the battery to rust.
- Do not touch or move any other component inside the remote control.
- Do not bend either of the battery terminals.

## Checking and replacing fuses

If any of the electrical components do not operate, a fuse may have blown. If this happens, check and replace the fuses as necessary.

- 1 Turn the engine switch off.
- 2 After a system failure, see "Fuse layout and amperage ratings" for details about which fuse to check. (→P. 651)
- 3 Open the Fuse box cover.

- ▶ Engine compartment (type A fuse box)

Push the tab in and lift the lid off.

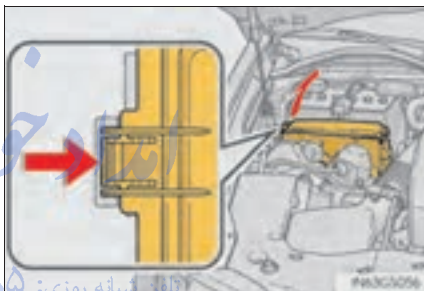

- ▶ Engine compartment (type B fuse box)

Push the tab in and lift the lid off.

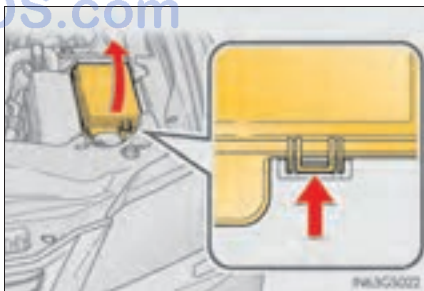

- ▶ Driver's side instrument panel

Remove the lid.

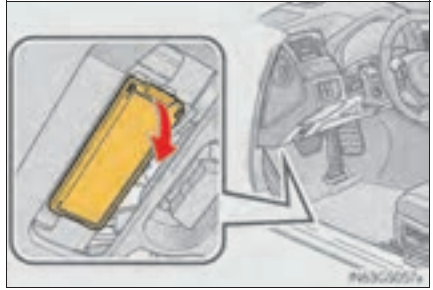

- ▶ Passenger's side instrument panel

Remove the lid.

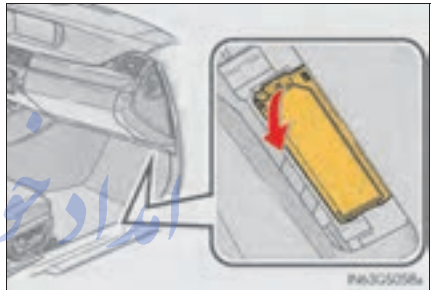

- ▶ Trunk

Push the tab in and lift the lid off.

تلفن: شماره روزی: ۰۲۱-۸۸۶۲۰۸۵

FarmaSOS.com



Remove the lid.



- 4** Remove the fuse with the pullout tool.

Only type A fuse can be removed using the pullout tool.

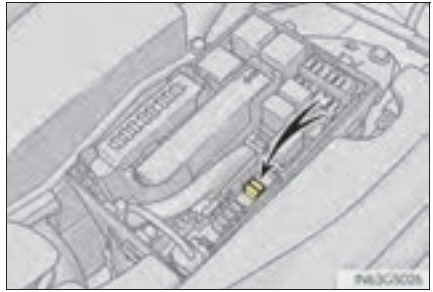

- 5** Check if the fuse is blown.

- ① Normal fuse
- ② Blown fuse

Type A and B:

Replace the blown fuse with a new fuse of an appropriate amperage rating. The amperage rating can be found on the fuse box lid.

Type C and D:

Contact your Lexus dealer.

▶ Type A

▶ Type B

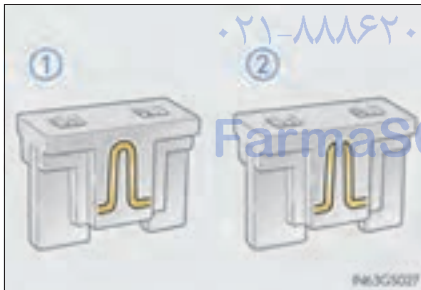

▶ Type C

▶ Type D





## Fuse layout and amperage ratings

### ■ Engine compartment (type A fuse box)

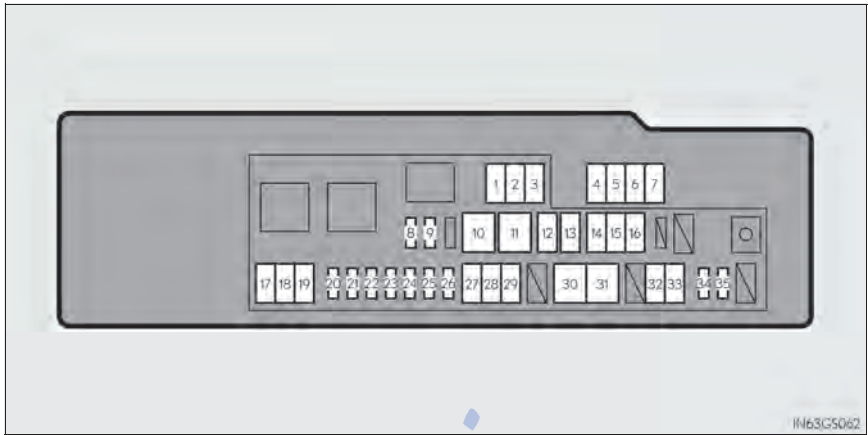

Fuse		Ampere	Circuit
1	LH J/B-B	40	Left-hand junction block
2	VGRS	40	VGRS
3	RH J/B-B	40	Right-hand junction block
4	P/I-B NO.2	80	F/PMP, EFI MAIN, A/F HTR, EDU, IG2 MAIN
5	ALT	150	RH J/B ALT, P/I ALT, LH J/B ALT, LUG J/B ALT
6	P/I ALT	100	RR DEF, TAIL, FR FOG, DEICER, PANEL, RR S/SHADE
7	RH J/B ALT	80	Right-hand junction block
8	MPX-B	10	Smart access system with push-button start, electric tilt and telescopic steering column, power seats, head-up display, front right-hand door ECU, gauges and meters, steering sensor, yaw rate and G sensor, overhead module, front left-hand door ECU, power trunk opener and closer, RR CTRL SW, clock, body ECU, CAN gateway ECU

Fuse		Ampere	Circuit
9	DOME	7.5	Personal lights, ornament lights, trunk light, footwell lights, door courtesy lights, vanity lights, rear door inside handle illuminations, power trunk opener and closer
10	EPS	80	EPS
11	ARS	80	Dynamic rear steering
12	HTR	50	Air conditioning system
13	ABS NO.1	40	VDIM
14	LUG J/B ALT	50	Luggage compartment junction block
15	PTC NO.1	50	PTC heater
16	PTC NO.2	50	PTC heater
17	ABS NO.2	50	VDIM
18	ST	30	Starting system
19	H-LP LO	30	Headlights, H-LP RLY
20	D/C CUT	30	DOME, MPX-B
21	DCM	7.5	DCM: تلفن شبانه روزی: ۰۲۱-۱۶۶۶۶۶۶۶
22	ECU-B	7.5	Smart access system with push-button start
23	ALT-S	7.5	Charging system
24	ETCS	10	Multiport fuel injection system/sequential multiport fuel injection system
25	HORN	10	Horn
26	R/B-B	20	EPS-B, ODS, TV
27	P/I-B NO.1	50	Headlights, daytime running lights
28	EPB	30	Parking brake
29	LUG J/B-B	40	Luggage compartment junction block
30	FAN NO.1	80	Electric cooling fans
31	LH J/B ALT	60	Left-hand junction block
32	H-LP CLN	30	Headlight cleaner

Fuse		Ampere	Circuit
33	FAN NO.2	40	Electric cooling fans
34	A/C COMP	7.5	Air conditioning system
35	FILTER	10	Condenser

### ■ Engine compartment (type B fuse box)

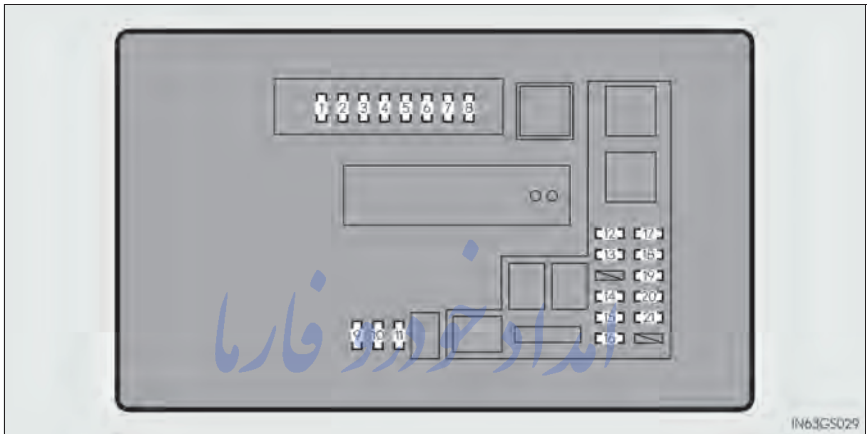

Fuse		Ampere	Circuit
1	IGN	10	Starting system
2	INJ	10	Multiport fuel injection system/sequential multiport fuel injection system
3	EFI NO.2	10	Fuel system, exhaust system
4	IG2 MAIN	20	IGN, GAUGE, INJ, AIR BAG, IG2 NO1, LH-IG2
5	EFI MAIN	25	Multiport fuel injection system/sequential multiport fuel injection system, EFI NO.2
6	A/F	15	Air intake system
7	EDU	20	Multiport fuel injection system/sequential multiport fuel injection system
8	F/PMP	25	Multiport fuel injection system/sequential multiport fuel injection system
9	SPARE	30	Spare fuse

Fuse		Ampere	Circuit
10	SPARE	20	Spare fuse
11	SPARE	10	Spare fuse
12	H-LP LH-LO	20	Left-hand headlight
13	H-LP RH-LO	20	Right-hand headlight
14	WASH-S	5	Driver support system
15	WIP-S	7.5	Windshield wipers, power management system
16	COMB SW	5	Windshield wipers
17	TV	7.5	Remote Touch screen
18	EPS-B	5	Electric power steering
19	ODS	5	Occupant classification system
20	IG2 NO.1	5	Power management system, DCM, CAN gateway ECU
21	GAUGE	5	Gauges and meters

تلفن شبانه روزی: ۰۸۵-۸۸۶۲۰۲۱

FarmaSOS.com

### ■ Driver's side instrument panel

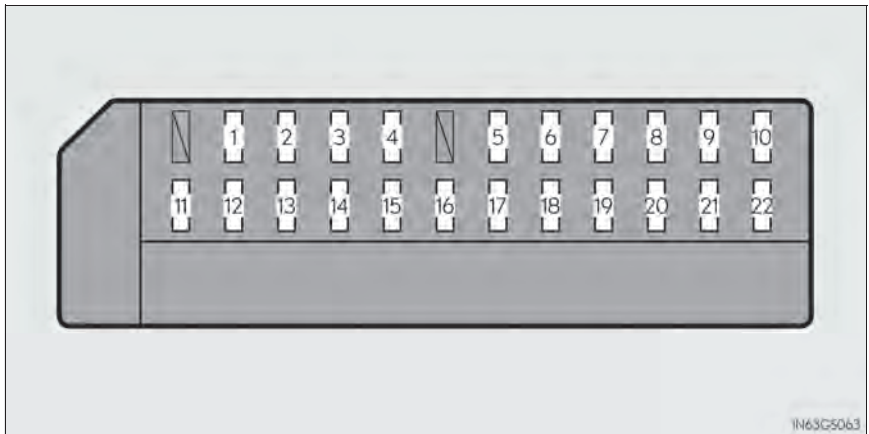

Fuse		Ampere	Circuit
1	STOP	7.5	Stop lights, high mounted stoplight
2	P/W-B	5	Power window master switch
3	P/SEAT1 F/L	30	Power seats
4	D/L NO.1	25	Power door lock system
5	NV-IR	10	Lexus night view تلفن
6	FL S/HTR	10	Seat heaters/ventilators
7	WIPER	30	Windshield wipers
8	WIPER-IG	5	Windshield wipers
9	LH-IG	10	Seat belts, body ECU, AFS, overhead module, raindrop sensor, inside rear view mirror, lane camera sensor (LKA), head-up display, shift lock system, intuitive parking assist, front left-hand door ECU, driver monitor system, Remote Touch screen, electric tilt and telescopic steering column, power seats, moon roof, intuitive parking assist switch
10	LH ECU-IG	10	VDIM, D-SW MODULE (Blind Spot Monitor, heated steering wheel), driver support system, AFS, EPB

Fuse		Ampere	Circuit
11	DOOR FL	30	Outside rear view mirror defoggers, power window (front left-hand)
12	CAPACITOR (HV)	10	No circuit
13	STRG LOCK	15	Steering lock
14	D/L NO.2	25	Power door lock system
15	DOOR RL	30	Power window (rear left-hand)
16	HAZ	15	Turn signal lights, emergency flashers
17	LH-IG2	10	Multipoint fuel injection system/sequential multipoint fuel injection system, stop lights, smart access system with push-button start, steering lock system
18	LH J/B-B	7.5	Body ECU
19	S/ROOF	20	Moon roof
20	P/SEAT2 F/L	25	Power seats
21	TI & TE	20	Electric tilt and telescopic steering column
22	A/C	7.5	Air conditioning system

### ■ Passenger's side instrument panel

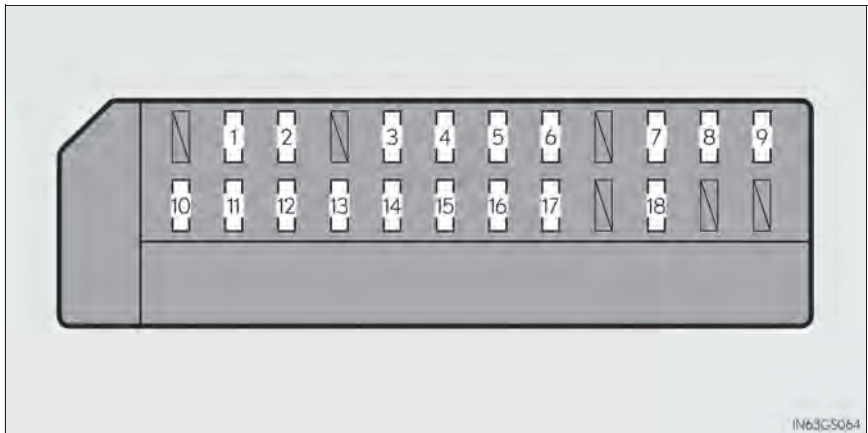

Fuse	Ampere	Circuit
1 P/SEAT1 F/R	30	Power seats
2 FR P/OUTLET	15	Power outlet (front)
3 RR P/OUTLET	15	Power outlet (rear)
4 P/SEAT2 F/R	25	Power seats
5 AVS	20	AVS تلفن شبانه روزی: ۰۲۱-۸۱۶۳۰۵۵
6 STRG HTR	15	Heated steering wheel
7 WASH	20	Windshield washer
8 RH ECU-IG	10	Navigation system, VGRS, pre-collision seat belts, air conditioning system, Lexus night view
9 RH-IG	10	Tension reducer, seat heater/ventilator switches, AWD system, front right-hand door ECU, CAN gateway ECU, tire pressure warning system, power seats, driver monitor system
10 DOOR FR	30	Front right-hand door control system (outside rear view mirror defoggers, power window)
11 DOOR RR	30	Power window (rear right-hand)
12 RAD NO.2	30	Audio system
13 AM2	7.5	Smart access system with push-button start

Fuse		Ampere	Circuit
14	MULTIMEDIA	10	Navigation system, Remote Touch
15	RAD NO.1	30	Audio system
16	AIR BAG	10	SRS airbag system, occupant classification system
17	OBD	7.5	On-board diagnosis system
18	ACC	7.5	Body ECU, head-up display, RR CTRL, navigation system, transmission, Remote Touch, DCM, Remote Touch screen

امداد خودرو فارما

تلفن شبانه روزی: ۰۲۱-۸۸۶۲۰۸۵

FarmaSOS.com



## ■ Trunk

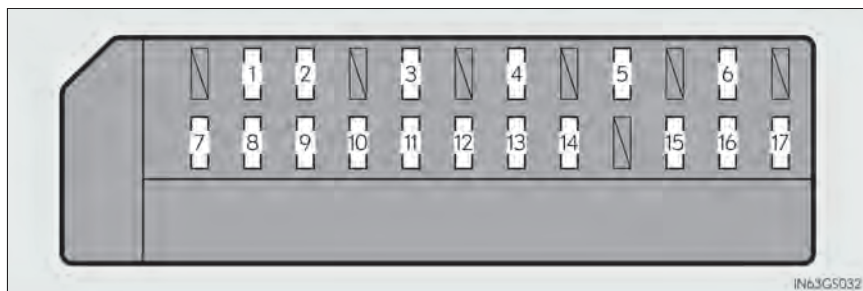

Fuse		Ampere	Circuit
1	PSB	30	Pre-collision seat belts
2	PTL	25	Power trunk opener and closer
3	RR J/B-B	10	Smart access system with push-button start
4	RR S/HTR	20	Seat heaters (rear)
5	FR S/HTR	10	Seat heaters/ventilators (front)
6	RR FOG	10	No circuit
7	DC/DC-S (HV)	7.5	No circuit
8	BATT FAN (HV)	20	No circuit
9	SECURITY	7.5	SECURITY
10	ECU-B NO.3	7.5	Parking brake
11	TRK OPN	7.5	Power trunk opener and closer
12	DCM (HV)	7.5	No circuit
13	AC INV (HV)	20	No circuit
14	RR-IG1	5	Radar sensor, Blind Spot Monitor
15	RR ECU-IG	10	Power trunk opener and closer, parking brake, tension reducer (rear left-hand), RR CTRL SW, tire pressure warning system, DRS
16	EPS-IG	5	Electric power steering system
17	BACK UP	7.5	Back-up lights

**■ After a fuse is replaced**

- If the lights do not turn on even after the fuse has been replaced, a bulb may need replacement. (→P. 663)
- If the replaced fuse blows again, have the vehicle inspected by your Lexus dealer.

**■ If there is an overload in a circuit**

The fuses are designed to blow, protecting the wiring harness from damage.

**■ When replacing light bulbs**

Lexus recommends that you use genuine Lexus products designed for this vehicle. Because certain bulbs are connected to circuits designed to prevent overload, non-genuine parts or parts not designed for this vehicle may be unusable.

**⚠ CAUTION****■ To prevent system breakdowns and vehicle fire**

Observe the following precautions.

Failure to do so may cause damage, and possibly a fire or injury.

- Never use a fuse of a higher amperage rating than that indicated, or use any other object in place of a fuse.
- Always use a genuine Lexus fuse or equivalent.  
Never replace a fuse with a wire, even as a temporary fix.  
This can cause extensive damage or even fire.
- Do not modify the fuses or fuse boxes.

**⚠ NOTICE****■ Before replacing fuses**

Have the cause of electrical overload determined and repaired by your Lexus dealer as soon as possible.

## Headlight aim

### Vertical movement adjusting bolts

- ① Adjustment bolt A
- ② Adjustment bolt B

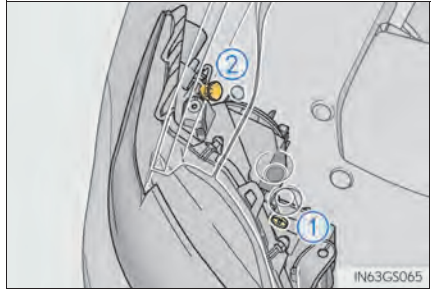

### Before checking the headlight aim

- ① Make sure the vehicle has a full tank of gasoline and the area around the headlight is not deformed.
- ② Park the vehicle on level ground.
- ③ Sit in the driver's seat.
- ④ Bounce the vehicle several times.

### Adjusting the headlight aim

- ① Using a Phillips-head screwdriver, turn bolt A in either direction.

Remember the turning direction and the number of turns.

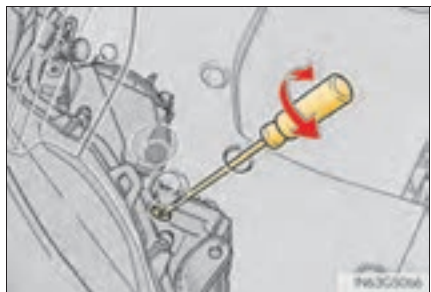

- 2** Turn bolt B the same number of turns and in the same direction as step **1**.

If the headlight cannot be adjusted using this procedure, take the vehicle to your Lexus dealer to adjust the headlight aim.

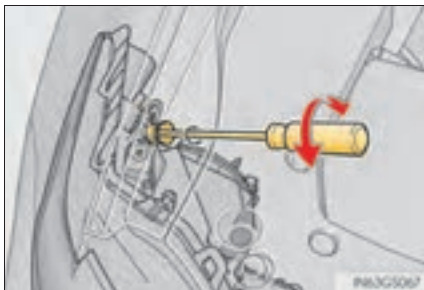

# امداد خودرو فارما

تلفن شبانه روزی: ۰۲۱-۸۸۸۶۲۰۸۵

[FarmaSOS.com](http://FarmaSOS.com)

## Light bulbs

You may replace the following bulbs by yourself. The difficulty level of replacement varies depending on the bulb. If necessary bulb replacement seems difficult to perform, contact your Lexus dealer.

For more information about replacing other light bulbs, contact your Lexus dealer.

### Preparing for light bulb replacement

Check the wattage of the light bulb to be replaced. (→P. 761)

### Removing the engine compartment covers

→P. 616

امداد خودرو فارما

تلفن شبانه روزی: ۰۲۱-۸۸۶۲۰۸۵

FarmaSOS.com

## Bulb locations

### ■ Front

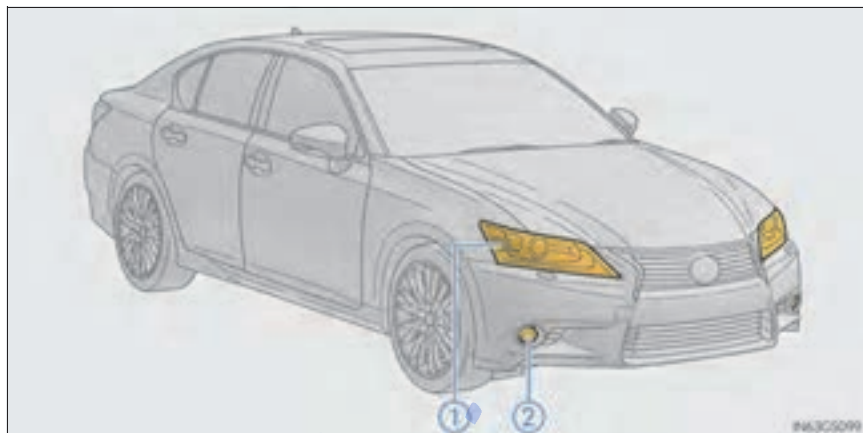

① Front turn signal light

② Fog light (if equipped)

### ■ Rear



① Back-up light

② Rear turn signal light

## Replacing light bulbs

### ■ Fog lights (if equipped)

- 1 To allow enough working space, turn the steering wheel to the opposite side of the bulb to be replaced.

Remove the 2 fender liner clips.

Turn the steering wheel to the left when replacing the right side light bulb, and turn the steering wheel to the right when replacing the left side light bulb.

To take out the clips, turn the head of the clip to unlock, then remove by pulling.

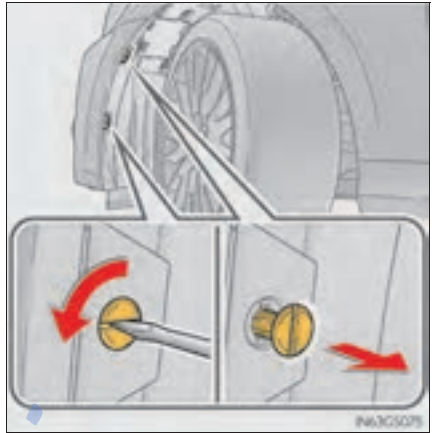

- 2 While holding the clamp open, pull and remove the tabs and open the fender liner.



- 3 Unplug the connector while pressing the lock release.

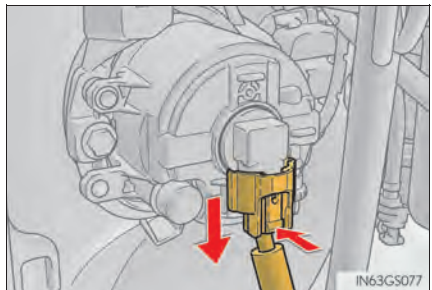

- 4** Turn the bulb base counter-clockwise.

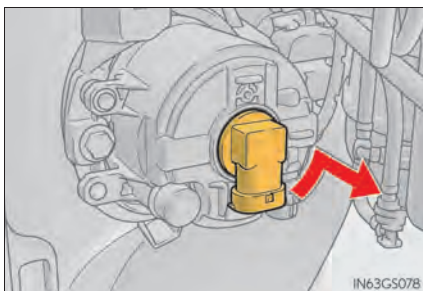

- 5** Set the new light bulb.

Align the 3 tabs on the light bulb with the mounting, and insert. Turn it clockwise to set.

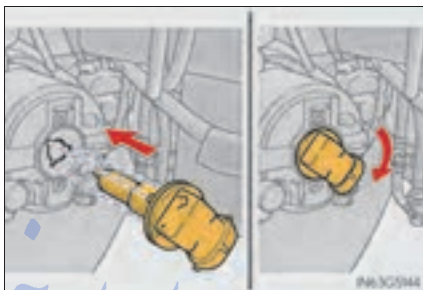

- 6** Set the connector.

After installing the connector, shake the bulb base gently to check that it is not loose, turn the fog lights on once and visually confirm that no light is leaking through the mounting.

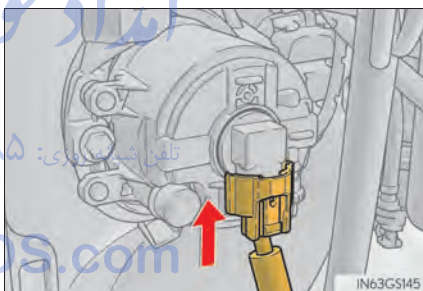

- 7** Reinstall the fender liner and install the clips.

Insert the clips and turn to lock.

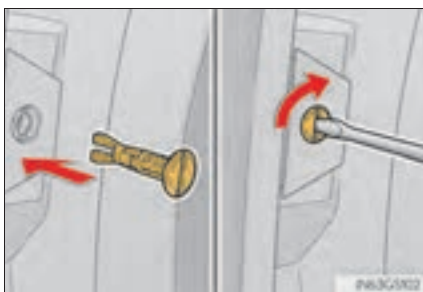



## ■ Front turn signal lights

- 1 For the left side only: To allow enough working space, turn the steering wheel all the way to the right, then remove the bolts and take off the cover.

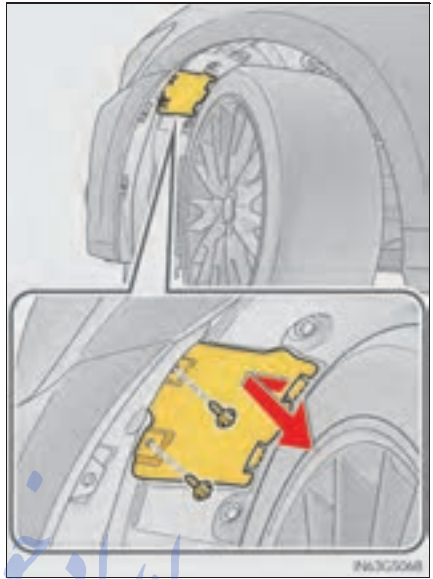

- 2 Turn the bulb base counterclockwise.

### ► Right side

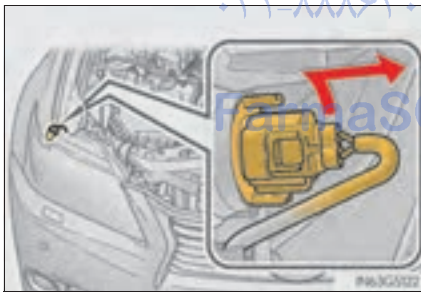

### ► Left side



- 3** Remove the light bulb.

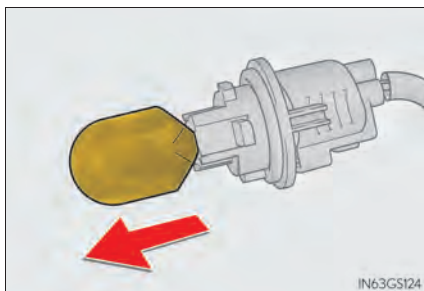

- 4** When installing, reverse the steps listed.

After installing the bulb base, secure the cord with the clips and install the cover\* in its original position.

\*: For the left side only



امداد خودرو فارما

تلفن شبانه روزی: ۰۲۱-۸۸۸۶۲۰۸۵

FarmaSOS.com

## ■ Rear turn signal lights

- 1 Open the trunk lid and remove the cover.

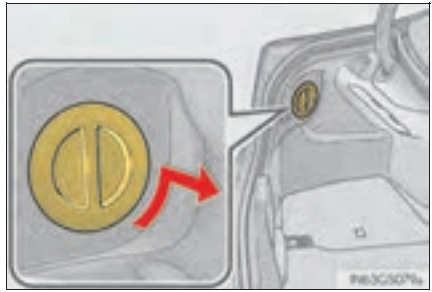

- 2 Turn the bulb base counter-clockwise.

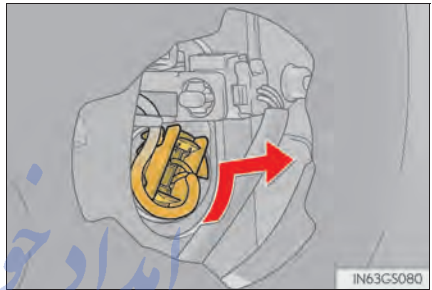

- 3 Remove the light bulb.

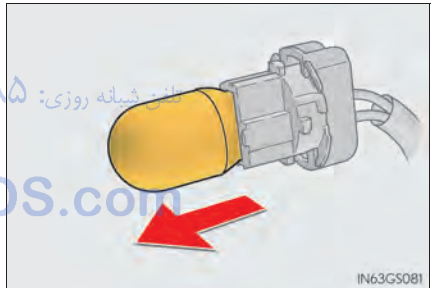

- 4 When installing, reverse the steps listed.

After installing the bulb base, secure the cord with the clips and install the cover in its original position.



## ■ Back-up lights

- 1 Open the trunk lid.
- 2 For the left side (vehicles with power trunk opener and closer only): Pry out each side of the trunk closer switch in turn by inserting a screwdriver into the base.

To prevent damage, cover the tip of the screwdriver with a rag.



- 3 Remove the clips on whichever side you are replacing and open the cover of the trunk lid.

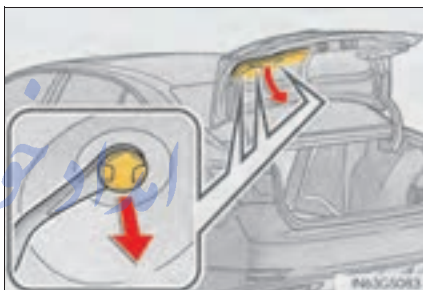

- 4 Turn the bulb base counter-clockwise.

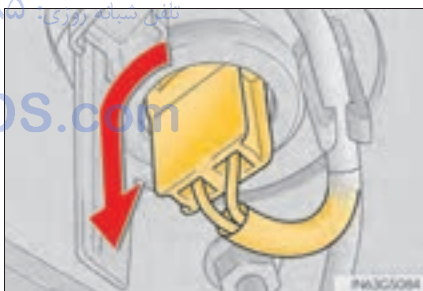

- 5 Remove the light bulb.

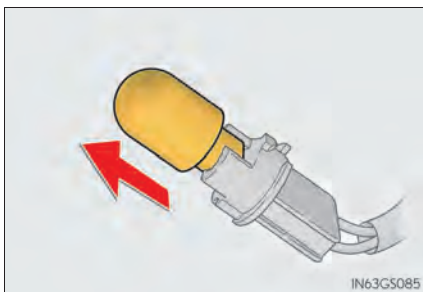

- 6 When installing, reverse the steps listed.

### ■ Replacing the following bulbs

If any of the lights listed below has burnt out, have it replaced by your Lexus dealer.

- Headlights
- Parking lights and daytime running lights
- Front side marker lights
- Side turn signal lights
- Stop/tail lights
- Tail lights
- Rear side marker lights
- High mounted stoplight
- License plate lights
- Outer foot lights

### ■ Discharge headlights

If voltage to the discharge bulbs is insufficient, the bulbs may not come on, or may go out temporarily. The discharge bulbs will come on when normal power is restored.

### ■ LED light bulbs

The lights other than the headlights, fog lights (if equipped), front turn signal lights, rear turn signal lights, back-up lights and outer foot lights each consist of a number of LEDs. If any of the LEDs burn out, take your vehicle to your Lexus dealer to have the light replaced.

### ■ Condensation build-up on the inside of the lens

Contact your Lexus dealer for more information in the following situations. Temporary condensation build-up on the inside of the headlight lens does not indicate a malfunction.

- Large drops of water have built up on the inside of the lens.
- Water has built up inside the headlight.

### ■ When replacing light bulbs

→P. 660

**⚠ CAUTION****■ Replacing light bulbs**

- Turn off the lights. Do not attempt to replace the bulb immediately after turning off the lights.  
The bulbs become very hot and may cause burns.
- Do not touch the glass portion of the light bulb with bare hands. Hold the bulb by the plastic or metal portion.  
If the bulb is scratched or dropped, it may blow out or crack.
- Fully install light bulbs and any parts used to secure them. Failure to do so may result in heat damage, fire, or water entering the headlight unit. This may damage the headlights or cause condensation to build up on the lens.
- While the headlights are turned on, and for a short time after they have been turned off, metal components at the rear of the headlight assembly will be extremely hot. To prevent burns, do not touch these metal components until you are certain they have cooled down.

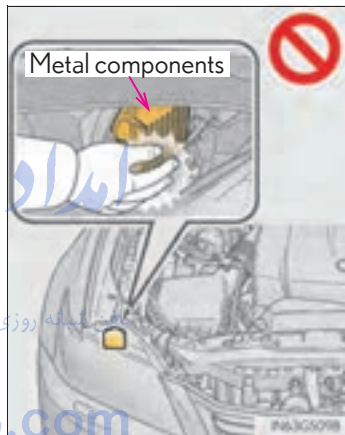

۰۲۱-۸۸۶۲۰۸۵ :تلفن شبانه روزی

FarmaSOS.com

**⚠ CAUTION****■ Discharge headlights**

- Contact your Lexus dealer before replacing the discharge headlights (including light bulbs).
- Do not touch the discharge headlight's high voltage socket when the headlights are turned on.  
An extremely high voltage of 30000 V will be discharged and could result in death or serious injury by electric shock.
- Do not attempt to take apart or repair the headlight bulbs, connectors, power supply circuits, or related components.  
Doing so could result in electric shock and death or serious injury.

**■ To prevent damage or fire**

- Make sure bulbs are fully seated and locked.
- Check the wattage of the bulb before installing to prevent heat damage.

امداد خودرو فارما

تلفن شبانه روزی: ۰۲۱-۸۸۶۲۰۸۵

FarmaSOS.com

# امداد خودرو فارما

تلفن شبانه روزی: ۰۲۱-۸۸۸۶۲۰۸۵

**FarmaSOS.com**



## When trouble arises

## 7

## 7-1. Essential information

Emergency flashers.....	676
If your vehicle has to be stopped in an emergency ....	677

## 7-2. Steps to take in an emergency

If your vehicle needs to be towed.....	678
If you think something is wrong.....	684
Fuel pump shut off system.....	685
If a warning light turns on or a warning buzzer sounds.....	686
If a warning message is displayed .....	697
If you have a flat tire.....	722
If the engine will not start.....	735
If the shift lever cannot be shifted from P .....	737
If the parking brake cannot be released.....	738
If the electronic key does not operate properly .....	740
If the vehicle battery is discharged .....	743
If your vehicle overheats .....	747
If the vehicle becomes stuck .....	749

ایران خودرو فارما

تلفن شماره ۰۲۱-۸۸۶۲۰۸۵

FarmaSOS.com

## Emergency flashers

The emergency flashers are used to warn other drivers when the vehicle has to be stopped in the road to a breakdown, etc.

Press the switch.

All the turn signals will flash.

To turn them off, press the switch once again.

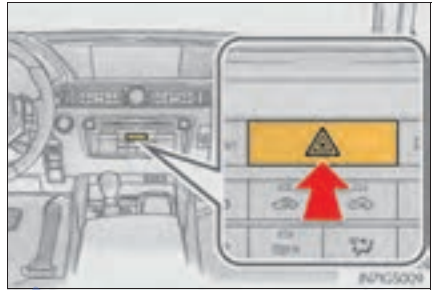

### ■ Emergency flashers

If the emergency flashers are used for a long time while the engine is not operating, the battery may discharge.

تلفن شبانه روزی: ۰۲۱-۸۸۶۲۰۸۵

FarmaSOS.com

## If your vehicle has to be stopped in an emergency

Only in an emergency, such as if it becomes impossible to stop the vehicle in the normal way, stop the vehicle using the following procedure:

- 1** Steadily step on the brake pedal with both feet and firmly depress it.
 

Do not pump the brake pedal repeatedly as this will increase the effort required to slow the vehicle.
- 2** Shift the shift lever to N.
  - ▶ If the shift lever is shifted to N
- 3** After slowing down, stop the vehicle in a safe place by the road.
- 4** Stop the engine.
  - ▶ If the shift lever cannot be shifted to N
- 3** Keep depressing the brake pedal with both feet to reduce vehicle speed as much as possible.
- 4** To stop the engine, press and hold the engine switch for 2 consecutive seconds or more, or press it briefly 3 times or more in succession.

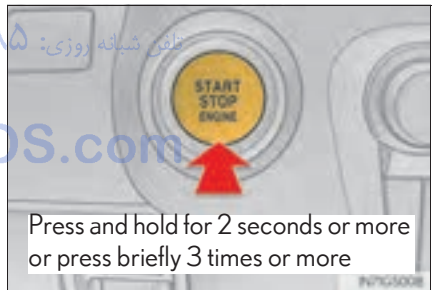

- 5** Stop the vehicle in a safe place by the road.

### **⚠ CAUTION**

#### **■ If the engine has to be turned off while driving**

Power assist for the brakes and steering wheel will be lost, making the brake pedal harder to depress and the steering wheel heavier to turn. Decelerate as much as possible before turning off the engine.

## If your vehicle needs to be towed

If towing is necessary, we recommend having your vehicle towed by your Lexus dealer or a commercial towing service, using a lift-type truck or flat bed truck.

Use a safety chain system for all towing, and abide by all state/provincial and local laws.

### Before towing

The following may indicate a problem with your transmission. Contact your Lexus dealer before towing.

- The engine is running but the vehicle will not move.
- The vehicle makes an abnormal sound.

### Emergency towing

If a tow truck is not available in an emergency, your vehicle may be temporarily towed using a cable or chain secured to the emergency towing eyelet. This should only be attempted on hard surfaced roads for short distances at low speeds.

A driver must be in the vehicle to steer and operate the brakes. The vehicle's wheels, drive train, axles, steering and brakes must be in good condition.

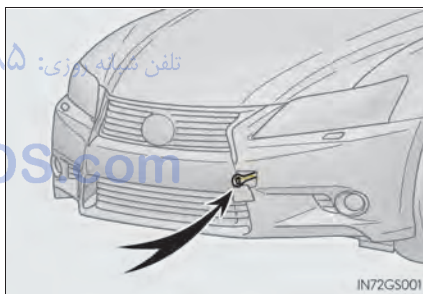

## Installing towing eyelet

- 1 Take out the towing eyelet (→P. 723)
- 2 Remove the eyelet cover using a flathead screwdriver.  
To protect the bodywork, place a rag between the screwdriver and the vehicle body as shown in the illustration.
- 3 Insert the towing eyelet into the hole and tighten partially by hand.

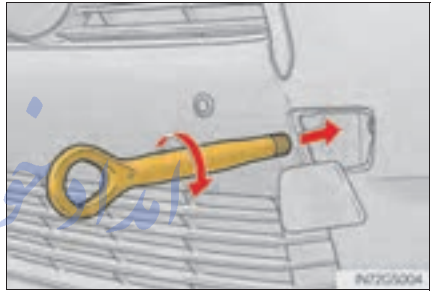
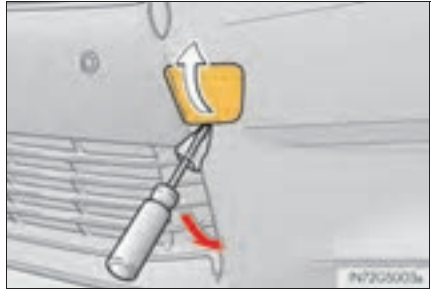

- 4 Tighten down the towing eyelet securely using a wheel nut wrench.

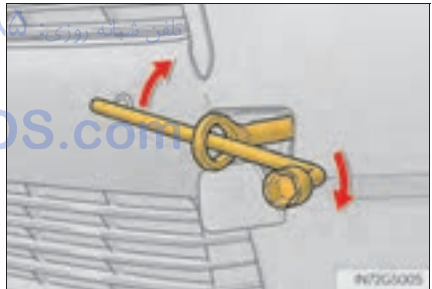

### Towing with a sling-type truck

Do not tow with a sling-type truck to prevent body damage.



### Towing with a wheel-lift type truck

- ▶ From the front

Use a towing dolly under the rear wheels.

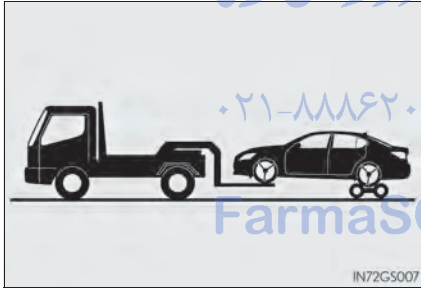

- ▶ From the rear (2WD models)

Turn the engine switch to ACCESSORY mode so that the steering wheel is unlocked.



- ▶ From the rear (AWD models)

Use a towing dolly under the front wheels.

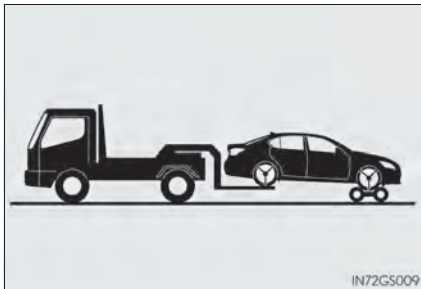

## Using a flat bed truck

If your Lexus is transported by a flat bed truck, it should be tied down at the locations shown in the illustration.

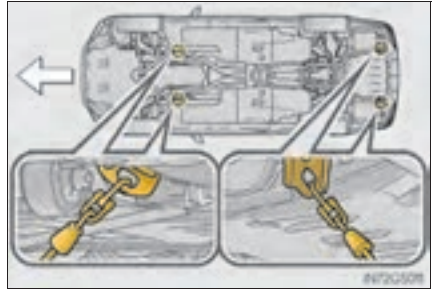

If you use chains or cables to tie down your vehicle, the angles shaded in black must be  $45^{\circ}$ .

Do not overly tighten the tie downs or the vehicle may be damaged.

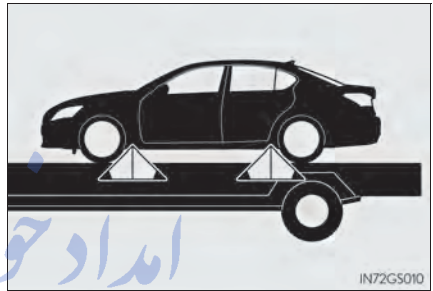

امداد خودرو فارما

تلفن شبانه روزی: ۰۲۱-۸۸۶۲۰۸۵

FarmaSOS.com

**■ Before emergency towing**

- 1** Release the parking brake.
- 2** Shift the shift lever to N.
- 3** Turn the engine switch to ACCESSORY (engine off) or IGNITION ON (engine running) mode.

**⚠ CAUTION**

Observe the following precautions.  
Failure to do so may result in death or serious injury.

**■ Caution while towing**

- Use extreme caution when towing the vehicle.  
Avoid sudden starts or erratic driving maneuvers which place excessive stress on the emergency towing eyelets and the cables or chains. Always be cautious of the surroundings and other vehicles while towing.
- If the engine is not running, the power assist for the brakes and steering will not function, making steering and braking more difficult.

**■ Installing towing eyelets to the vehicle**

Make sure that towing eyelets are installed securely.  
If not securely installed, towing eyelets may come loose during towing.



 NOTICE

■ **To prevent causing serious damage to the transmission and transfer (AWD models) when towing using a wheel-lift type truck**

2WD models:

Never tow this vehicle from the front with the rear wheels on the ground.

AWD models:

Never tow this vehicle with any of the wheels in contact with the ground.

■ **To prevent damage to the vehicle when towing using a wheel-lift type truck**

2WD models:

- Do not tow the vehicle from the rear with the engine switch off. The steering lock mechanism is not strong enough to hold the front wheels straight.

- When raising the vehicle from the rear, ensure adequate ground clearance for towing at the opposite end of the raised vehicle. Without adequate clearance, the vehicle could be damaged while being towed from the rear.

AWD models:

When raising the vehicle, ensure adequate ground clearance for towing at the opposite end of the raised vehicle. Without adequate clearance, the vehicle could be damaged while being towed.

■ **To prevent body damage when towing with a sling-type truck**

Do not tow with a sling-type truck, either from the front or rear.

■ **To prevent causing serious damage to the transmission and transfer (AWD models) in emergency towing**

Never tow a vehicle from the rear with four wheels on the ground. This may cause serious damage to the transmission and transfer.

## If you think something is wrong

If you notice any of the following symptoms, your vehicle probably needs adjustment or repair. Contact your Lexus dealer as soon as possible.

### Visible symptoms

- Fluid leaks under the vehicle.  
(Water dripping from the air conditioning after use is normal.)
- Flat-looking tires or uneven tire wear
- Engine coolant temperature gauge needle continually points higher than normal.

### Audible symptoms

- Changes in exhaust sound
- Excessive tire squeal when cornering
- Strange noises related to the suspension system
- Pinging or other noises related to the engine

### Operational symptoms

- Engine missing, stumbling or running roughly
- Appreciable loss of power
- Vehicle pulls heavily to one side when braking
- Vehicle pulls heavily to one side when driving on a level road
- Loss of brake effectiveness, spongy feeling, pedal almost touches the floor

## Fuel pump shut off system

To minimize the risk of fuel leakage when the engine stalls or when an airbag inflates upon collision, the fuel pump shut off system stops the supply of fuel to the engine.

Follow the procedure below to restart the engine after the system is activated.

- 1 Turn the engine switch to ACCESSORY mode or turn it off.
- 2 Restart the engine.



### NOTICE

#### ■ Before starting the engine

Inspect the ground under the vehicle.

If you find that fuel has leaked onto the ground, the fuel system has been damaged and is in need of repair. Do not restart the engine.

تلفن شبانه روزی: +۲۱-۸۸۶۲۰۸۵



FarmaSOS.com

## If a warning light turns on or a warning buzzer sounds

Calmly perform the following actions if any of the warning lights comes on or flashes. If a light comes on or flashes, but then goes off, this does not necessarily indicate a malfunction in the system. However, if this continues to occur, have the vehicle inspected by your Lexus dealer.

**Stop the vehicle immediately. Continuing to drive the vehicle may be dangerous.**

The following warning indicates a possible problem in the brake system. Immediately stop the vehicle in a safe place and contact your Lexus dealer.

Warning light	Warning light/Details
 <p>(U.S.A.)</p>  <p>(Canada)</p>	<p><b>Brake system warning light (warning buzzer)</b></p> <ul style="list-style-type: none"> <li>• Low brake fluid</li> <li>• Malfunction in the brake booster system</li> </ul> <p>FarmaSOS.com</p>







## Stop the vehicle immediately.





The following warning indicates the possibility of damage to the vehicle that may lead to an accident. Immediately stop the vehicle in a safe place and contact your Lexus dealer.

Warning light	Warning light/Details
	<b>Charging system warning light</b> Indicates a malfunction in the vehicle's charging system

## Have the vehicle inspected by your Lexus dealer immediately.

Failure to investigate the cause of the following warnings may lead to the system operating abnormally and possibly cause an accident. Have the vehicle inspected by your Lexus dealer immediately.





Warning light	Warning light/Details
 (U.S.A.)  (Canada)	<b>Malfunction indicator lamp</b> Indicates a malfunction in: <ul style="list-style-type: none"> <li>• The electronic engine control system;</li> <li>• The electronic throttle control system; or</li> <li>• The electronic automatic transmission control system</li> </ul>
	<b>SRS warning light</b> Indicates a malfunction in: <ul style="list-style-type: none"> <li>• The SRS airbag system;</li> <li>• The front passenger occupant classification system; or</li> <li>• The seat belt pretensioner system</li> </ul>
 (U.S.A.)  (Canada)	<b>ABS warning light</b> Indicates a malfunction in: <ul style="list-style-type: none"> <li>• The ABS; or</li> <li>• The brake assist system</li> </ul>
	<b>Electric power steering system warning light</b> Indicates a malfunction in the EPS (Electric Power Steering) system

Warning light	Warning light/Details
 <p><b>PCS</b> (Flashes) (If equipped)</p>	<p><b>Pre-collision system warning light</b> Indicates a malfunction in the pre-collision system The warning light will operate as follows, even when the system is not malfunctioning:</p> <ul style="list-style-type: none"> <li>• The light will flash quickly when the system is operating. (→P. 278)</li> <li>• The light will turn on when the pre-collision system is disabled. (→P. 280)</li> <li>• The light will flash when the system cannot temporarily be used. (→P. 708)</li> </ul>
	<p><b>Slip indicator</b> Indicates a malfunction in:</p> <ul style="list-style-type: none"> <li>• The VSC system;</li> <li>• The TRAC system; or</li> <li>• The hill-start assist control system</li> </ul> <p>The light will flash when the VSC, the TRAC or the hill-start assist control system is operating.</p>
 <p><b>AFS OFF</b> (Flashes) (If equipped)</p>	<p><b>“AFS OFF” indicator</b> Indicates a malfunction in the adaptive front-lighting system</p> <p>تلفن شبانه روزی: ۰۲۱-۸۸۶۲۰۸۵</p>
 <p><b>PARK</b> (Flashes) (U.S.A.)</p>  <p>(Flashes) (Canada)</p>	<p><b>FarmaSOS.com</b></p> <p><b>Parking brake indicator</b> Indicates a malfunction in the parking brake system</p>

Warning light	Warning light/Details
	<b>Brake system warning light</b> Indicates a malfunction in the parking brake system

### Follow the correction procedures.

After taking the specified steps to correct the suspected problem, check that the warning light goes off.

Warning light	Warning light/Details	Correction procedure
	<b>Open door warning light (warning buzzer)*<sup>1</sup></b> Indicates that a door or the trunk is not fully closed	Check that all the doors and the trunk are closed.
	<b>Low fuel level warning light</b> Indicates remaining fuel is approximately 2.8 gal. (10.5 L, 2.3 Imp.gal.) or less	Refuel the vehicle.
	<b>Seat belt reminder light (warning buzzer)*<sup>2</sup></b> Warns the driver and/or front passenger to fasten their seat belts	Fasten the seat belt. If the front passenger's seat is occupied, the front passenger's seat belt also needs to be fastened to make the warning light (warning buzzer) off.
	<b>Master warning light</b> A buzzer sounds and the warning light comes on and flashes to indicate that the master warning system has detected a malfunction.	→P. 697

Warning light	Warning light/Details	Correction procedure
	<b>Tire pressure warning light</b>	
	When the light comes on: Low tire inflation pressure such as <ul style="list-style-type: none"> <li>• Natural causes (→P. 693)</li> <li>• Flat tire (→P. 722)</li> </ul>	Adjust the tire inflation pressure to the specified level. The light will turn off after a few minutes. In case the light does not turn off even if the tire inflation pressure is adjusted, have the system checked by your Lexus dealer.
	When the light comes on after blinking for 1 minute: Malfunction in the tire pressure warning system	Have the system checked by your Lexus dealer.

امداد خودرو فارما

تلفن شبانه روزی: ۰۲۱-۸۸۶۲۰۸۵

FarmaSOS.com



\*1: Open door warning buzzer:

→P. 704

\*2: Driver's seat belt buzzer:

The driver's seat belt buzzer sounds to alert the driver that his or her seat belt is not fastened. Once the engine switch is turned to IGNITION ON mode, the buzzer sounds for 6 seconds. If the vehicle reaches a speed of 12 mph (20 km/h), the buzzer sounds once. If the seat belt is still unfastened after 30 seconds, the buzzer will sound intermittently for 10 seconds. Then, if the seat belt is still unfastened, the buzzer will sound in a different tone for 20 more seconds.

Front passenger's seat belt buzzer:

The front passenger's seat belt buzzer sounds to alert the front passenger that his or her seat belt is not fastened. The buzzer sounds once if the vehicle reaches a speed of 12 mph (20 km/h). If the seat belt is still unfastened after 30 seconds, the buzzer will sound intermittently for 10 seconds. Then, if the seat belt is still unfastened, the buzzer will sound in a different tone for 20 more seconds.

امداد خودرو فارما

تلفن شبانه روزی: ۰۲۱-۸۸۶۲۰۸۵

FarmaSOS.com

### ■ SRS warning light

This warning light system monitors the airbag sensor assembly, front impact sensors, side impact sensors (front door), side impact sensors (front), side impact sensors (rear), driver's seat position sensor, driver's seat belt buckle switch, front passenger occupant classification system, "AIR BAG ON" indicator light, "AIR BAG OFF" indicator light, front passenger's seat belt buckle switch, seat belt pretensioner assemblies, inflators, interconnecting wiring and power sources. (→P. 38)

### ■ Front passenger detection sensor, seat belt reminder and warning buzzer

If luggage is placed on the front passenger seat, the front passenger detection sensor may cause the warning light to flash and the warning buzzer to sound even if a passenger is not sitting in the seat.

### ■ If the malfunction indicator lamp comes on while driving

First check the following:

- Is the fuel tank empty?  
If it is, fill the fuel tank immediately.
- Is the fuel tank cap loose?  
If it is, tighten it securely.

The light will go off after several driving trips.

If the light does not go off even after several trips, contact your Lexus dealer as soon as possible.

### ■ Changing the engine oil (U.S.A. only)

Make sure to reset the oil change system. (→P. 602)

### ■ When the tire pressure warning light comes on

Check the tire inflation pressure and adjust to the appropriate level. Pushing the tire pressure warning reset switch will not turn off the tire pressure warning light.

**■ The tire pressure warning light may come on due to natural causes**

The tire pressure warning light may come on due to natural causes such as natural air leaks and tire inflation pressure changes caused by temperature. In this case, adjusting the tire inflation pressure will turn off the warning light (after a few minutes).

**■ When a tire is replaced with a spare tire**

The compact spare tire is not equipped with a tire pressure warning valve and transmitter. If a tire goes flat, the tire pressure warning light will not turn off even though the flat tire has been replaced with the spare tire.

**■ Conditions that the tire pressure warning system may not function properly**

→P. 635

**■ If the tire pressure warning light frequently comes on after blinking for 1 minute**

If the tire pressure warning light frequently comes on after blinking for 1 minute when the engine switch is turned to IGNITION ON mode, have it checked by your Lexus dealer.

**■ Warning buzzer**

In some cases, the buzzer may not be heard because of noisy place or an audio sound.

امداد خودرو فارما

تلفن شبانه روزی: ۰۲۱-۸۸۶۲۰۸۵

FarmaSOS.com

**⚠ CAUTION****■ If both the ABS and the brake system warning lights remain on**

Stop your vehicle in a safe place immediately and contact your Lexus dealer. The vehicle will become extremely unstable during braking, and the ABS system may fail, which could cause an accident resulting in death or serious injury.

**■ When the electric power steering system warning light comes on**

The steering wheel may become extremely heavy.  
If the steering wheel becomes heavier than usual when operating, hold firmly and operate using more force than usual.

**■ If the tire pressure warning light comes on**

Be sure to observe the following precautions. Failure to do so could cause a loss of vehicle control and result in death or serious injury.

- Stop your vehicle in a safe place as soon as possible. Adjust the tire inflation pressure immediately.
- If the tire pressure warning light comes on even after tire inflation pressure adjustment, it is probable that you have a flat tire. Check the tires. If a tire is flat, change it with the spare tire and have the flat tire repaired by the nearest Lexus dealer.
- Avoid abrupt maneuvering and braking. If the vehicle tires deteriorate, you could lose control of the steering wheel or the brakes.

**■ If a blowout or sudden air leakage should occur** تلفن شبانه روز

The tire pressure warning system may not activate immediately.

 CAUTION**■ Maintenance of the tires**

Each tire, including the spare (if provided), should be checked monthly when cold and inflated to the inflation pressure recommended by the vehicle manufacturer on the vehicle placard or tire inflation pressure label (tire and load information label). (If your vehicle has tires of a different size than the size indicated on the vehicle placard or tire inflation pressure label [tire and load information label], you should determine the proper tire inflation pressure for those tires.)

As an added safety feature, your vehicle has been equipped with a tire pressure monitoring system (TPMS-tire pressure warning system) that illuminates a low tire pressure telltale (tire pressure warning light) when one or more of your tires is significantly under-inflated. Accordingly, when the low tire pressure telltale (tire pressure warning light) illuminates, you should stop and check your tires as soon as possible, and inflate them to the proper pressure. Driving on a significantly under-inflated tire causes the tire to overheat and can lead to tire failure. Under-inflation also reduces fuel efficiency and tire tread life, and may affect the vehicle's handling and stopping ability.

Please note that the TPMS (tire pressure warning system) is not a substitute for proper tire maintenance, and it is the driver's responsibility to maintain correct tire pressure, even if under-inflation has not reached the level to trigger illumination of the TPMS low tire pressure telltale (tire pressure warning light).

Your vehicle has also been equipped with a TPMS (tire pressure warning system) malfunction indicator to indicate when the system is not operating properly. The TPMS (tire pressure warning system) malfunction indicator is combined with the low tire pressure telltale (tire pressure warning light). When the system detects a malfunction, the telltale will flash for approximately one minute and then remain continuously illuminated. This sequence will continue upon subsequent vehicle start-ups as long as the malfunction exists. When the malfunction indicator is illuminated, the system may not be able to detect or signal low tire pressure as intended.

 CAUTION

TPMS (tire pressure warning system) malfunctions may occur for a variety of reasons, including the installation of replacement or alternate tires or wheels on the vehicle that prevent the TPMS (tire pressure warning system) from functioning properly. Always check the TPMS (tire pressure warning system) malfunction tell-tale after replacing one or more tires or wheels on your vehicle to ensure that the replacement or alternate tires and wheels allow the TPMS (tire pressure warning system) to continue to function properly.

 NOTICE**■ Precaution when installing a different tire**

When differently constructed tires or tires of different makers, models or tread patterns are installed, the tire pressure warning system may not operate properly.

امداد خودرو فارما

تلفن شبانه روزی: ۰۲۱-۸۸۶۲۰۸۵

FarmaSOS.com

## If a warning message is displayed

If a warning is shown on the multi-information display, stay calm and perform the following actions:

① Master warning light

The master warning light also comes on or flashes in order to indicate that a message is currently being displayed on the multi-information display.

② Multi-information display



If any of the warning light comes on again after the following actions have been performed, contact your Lexus dealer.

**Stop the vehicle immediately. Continuing to drive the vehicle may be dangerous.**

The following warning indicates a possible problem in the brake system. Immediately stop the vehicle in a safe place and contact your Lexus dealer.

Warning message	Details
<div style="background-color: black; color: white; padding: 5px; text-align: center; margin-bottom: 5px;">Brake Malfunction</div> <div style="display: flex; flex-direction: column; gap: 5px;"> <div style="display: flex; align-items: center;"> <div style="background-color: black; color: red; padding: 2px 5px; font-weight: bold; margin-right: 5px;">BRAKE</div> <span>(U.S.A.)</span> </div> <div style="display: flex; align-items: center;"> <div style="background-color: black; color: red; padding: 2px 5px; font-size: 1.5em; margin-right: 5px;">(!)</div> <span>(Canada)</span> </div> <div style="display: flex; align-items: center;"> <div style="background-color: black; color: yellow; padding: 2px 5px; font-size: 1.5em; margin-right: 5px;">!</div> </div> </div>	<p>Indicates the following:</p> <ul style="list-style-type: none"> <li>The brake fluid level is low; or,</li> <li>The brake booster system is malfunctioning.</li> </ul> <p>A buzzer also sounds.</p>

### Stop the vehicle immediately.

A buzzer sounds and a warning message is shown on the multi-information display. The following warning indicates the possibility of damage to the vehicle that may lead to an accident. Immediately stop the vehicle in a safe place and contact your Lexus dealer.

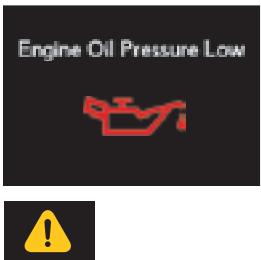
Warning message	Details
	<p>Indicates abnormal engine oil pressure The warning light may come on if the engine oil pressure is too low.</p>

امداد خودرو فارما







تلفن شبانه روزی: ۰۲۱-۸۸۶۲۰۸۵









FarmaSOS.com

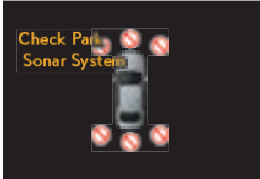

## Have the vehicle inspected immediately.



A buzzer sounds and a warning message is shown on the multi-information display. Failure to investigate the cause of the following warnings may lead to the system operating abnormally and possibly cause an accident. Have the vehicle inspected by your Lexus dealer.

Warning message	Details
  (AWD models)	Indicates a malfunction in the AWD system
 	Indicates that the automatic transmission fluid temperature is too high
  (If equipped)	Indicates a malfunction in the pre-collision system

Warning message	Details
  <p>(If equipped)</p>	<p>Indicates a malfunction in the intuitive parking assist The malfunctioning assist-sensor is flashing.</p>
 	<p>Indicates a malfunction in the dynamic radar cruise control system (if equipped) or the cruise control system Press the "ON-OFF" button once to deactivate the system, and then press the button again to reactivate the system.</p>
  <p>(If equipped)</p>	<p>Indicates a malfunction in the LKA (Lane-Keeping Assist)</p>
  <p>(If equipped)</p>	<p>Indicates a malfunction in the automatic headlight leveling system</p>

Warning message	Details
<p data-bbox="128 164 388 289"><b>Check AFS</b></p>  <p data-bbox="189 375 327 407">(If equipped)</p>	<p data-bbox="412 253 969 315">Indicates a malfunction in the adaptive front-lighting system</p>
<p data-bbox="128 446 388 571"><b>Check SRS Airbag System</b></p> 	<p data-bbox="412 467 678 493">Indicates a malfunction in:</p> <ul data-bbox="412 500 969 623" style="list-style-type: none"> <li data-bbox="412 500 678 526">• The SRS airbag system;</li> <li data-bbox="412 532 969 591">• The front passenger occupant classification system; or,</li> <li data-bbox="412 597 780 623">• The seat belt pretensioner system</li> </ul>
<p data-bbox="128 686 388 812"><b>Check ABS</b></p> <p data-bbox="128 828 388 886"><b>ABS</b> (U.S.A.)</p> <p data-bbox="128 902 388 961"><b>(ABS)</b> (Canada)</p>	<p data-bbox="412 776 678 802">Indicates a malfunction in:</p> <ul data-bbox="412 808 732 867" style="list-style-type: none"> <li data-bbox="412 808 564 834">• The ABS; or,</li> <li data-bbox="412 841 732 867">• The brake assist system</li> </ul>
<p data-bbox="128 1003 388 1128"><b>Parking Brake Inoperable</b></p> <p data-bbox="128 1144 388 1203"><b>PARK</b> (Flashes) (U.S.A.)</p> <p data-bbox="128 1219 388 1278"><b>(P)</b> (Flashes) (Canada)</p> 	<p data-bbox="412 1162 940 1188">Indicates a malfunction in the parking brake system</p>

Warning message	Details
<p data-bbox="130 167 389 289">Check Parking Brake System</p> 	<p data-bbox="410 248 942 280">Indicates a malfunction in the parking brake system</p>
<p data-bbox="130 410 389 532">Check Power Steering System</p>  	<p data-bbox="410 508 969 573">Indicates a malfunction in the EPS (Electric Power Steering) system</p>
<p data-bbox="130 727 389 849">Check VGRS System</p>  <p data-bbox="189 930 327 963">(If equipped)</p>	<p data-bbox="410 824 788 857">Indicates a malfunction in the VGRS</p>
<p data-bbox="130 1011 389 1133">Check DRS System</p>  <p data-bbox="189 1214 327 1247">(If equipped)</p>	<p data-bbox="410 1109 767 1141">Indicates a malfunction in the DRS</p>

Warning message	Details
<p data-bbox="129 165 387 289">Check BSM System</p> <p data-bbox="129 305 221 367"> (Flashes)</p> <p data-bbox="193 376 327 409">(If equipped)</p>	<p data-bbox="412 269 917 302">Indicates a malfunction in the Blind Spot Monitor</p>
<p data-bbox="129 449 387 573">Check Access System with Elec. Key</p> <p data-bbox="129 589 221 651"> (Flashes)</p>	<p data-bbox="412 514 970 576">Indicates a malfunction in the smart access system with push-button start</p>





امداد خودرو فارما



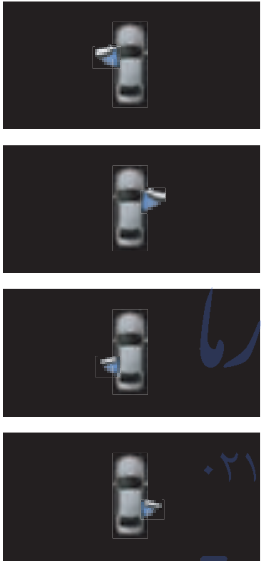

تلفن شبانه روزی: ۰۲۱-۸۸۶۲۰۸۵

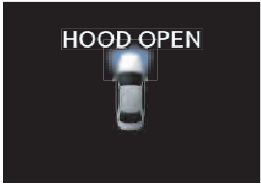







FarmaSOS.com

### Follow the correction procedures.

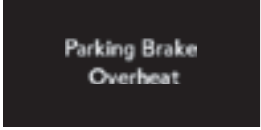







A buzzer sounds and a warning message is shown on the multi-information display. After taking the specified steps to correct the suspected problem, check that the warning message goes off.



Warning message	Details	Correction procedure
	<p>Indicates that one or more of the doors is not fully closed</p> <p>The system also indicates which doors are not fully closed.</p> <p>If the vehicle reaches a speed of 3 mph (5 km/h),  flashes and a buzzer sounds to indicate that the door(s) are not yet fully closed.</p>	<p>Make sure that all the doors are closed.</p>
	<p>Indicates that the hood is not fully closed</p> <p>If the vehicle reaches a speed of 3 mph (5 km/h),  flashes and a buzzer sounds to indicate that the hood is not yet fully closed.</p>	<p>Close the hood.</p>

Warning message	Details	Correction procedure
 <p>TRUNK OPEN</p>	<p>Indicates that the trunk is not fully closed</p> <p>If the vehicle reaches a speed of 3 mph (5 km/h),  flashes and a buzzer sounds to indicate that the trunk is not yet fully closed.</p>	<p>Close the trunk.</p>
<p>Window opened</p>  (Flashes)	<p>Indicates that the windows are not fully closed (with the engine switch off, and the driver's door open)</p>	<p>Close all the windows.</p>
<p>Moon Roof opened</p>  (Flashes)	<p>Indicates that the moon roof is not fully closed (with the engine switch off, and the driver's door open)</p>	<p>Close the moon roof.</p>
<p>Window/ Moon Roof opened</p>  (Flashes)	<p>Indicates that the windows and the moon roof are not fully closed (with the engine switch off, and the driver's door open)</p>	<p>Close all the windows and the moon roof.</p>

Warning message	Details	Correction procedure
	<p>Indicates that the parking brake is still engaged</p> <p>If the vehicle reaches a speed of 3 mph (5 km/h),  flashes and a buzzer sounds to indicate that the parking brake is still engaged.</p>	<p>Release the parking brake.</p>
 <p> (Flashes) (U.S.A.)</p> <p> (Flashes) (Canada)</p> <p> (Flashes)</p>	<p>Indicates that the parking brake system has overheated</p>	<p>Wait until the system cools down.</p>
<p>1st Gear not available due to slippery road surface</p> 	<p>Indicates that shift range 1 has been selected with the shift lever in M when driving on slippery road surfaces.</p> <p>The range will not be downshifted and remain 2.</p>	<p>Drive with the shift range higher than 2.</p>
 	<p>Indicates that engine oil level is low</p>	<p>Check the level of engine oil, and add if necessary.</p>









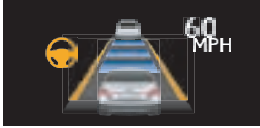

Warning message	Details	Correction procedure
  <p>(If equipped)</p>	<p>Indicates that intuitive parking assist sensor is dirty or covered with ice</p>	<p>Clean the sensor.</p>
  <p>(If equipped)</p>	<p>Indicates that the radar sensor is dirty or covered with ice</p>	<p>Clean the sensor.</p>
  <p>(If equipped)</p>	<p>Indicates that the radar cruise control system is unable to judge vehicle-to-vehicle distance</p>	<ul style="list-style-type: none"> <li>• Turn off the snow mode.</li> <li>• If the windshield wipers are on, turn them off or set them to a mode other than AUTO or high speed wiper operation.</li> </ul>
 <p>(If equipped)</p>	<p>Indicates that your vehicle is nearing the vehicle ahead (in vehicle-to-vehicle distance mode)</p> <p>At the same time,  will appear on the head-up display (the image flashes).</p>	<p>Slow the vehicle by applying the brakes.</p>

Warning message	Details	Correction procedure
 <p><b>PCS</b> (Flashes) (If equipped)</p>	<p>Indicates that there is a high possibility of a frontal collision, or that the pre-collision braking function is operating</p> <p>At the same time, <b>BRAKE!</b> will appear on the head-up display too (the image flashes).</p>	<p>Slow the vehicle by applying the brakes.</p>
  <p>(If equipped)</p>	<p>Indicates that the LKA (Lane-Keeping Assist) is suspended</p> <ul style="list-style-type: none"> <li>• The camera sensor temperature is higher than the operation temperature range.</li> <li>• The power steering system operation is restricted.</li> </ul>	<p>Restart the LKA after driving for a while.</p>

تلفن شبانه روزی: ۰۲۱-۸۸۶۲۰۸۵

FarmaSOS.com

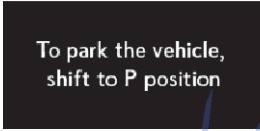
Warning message	Details	Correction procedure
 <p>(If equipped)</p>	<p>Alerts the driver that the vehicle is out of the lanes (while the LKA [Lane-Keeping Assist] system is operating)</p> <p>The warning buzzer sounds continuously. The lane markings and/or the steering wheel marking flash. At the same time,  will appear on the head-up display (part of the image flashes).</p>	<p>Check around the vehicle and back to inside of the lane markings.</p>
<p>LKA canceled Keep hands on steering wheel</p>  <p>(If equipped)</p>	<p>Indicates that the LKA (Lane-Keeping Assist) system detects no-handed driving (while the lane keeping assist function is operating). The warning buzzer sounds twice.</p>	<p>Grip the steering wheel firmly.</p>
<p>BSM not available</p>  <p>(If equipped)</p>	<p>Indicates that the Blind Spot Monitor sensors or the surrounding area on the bumper is dirty or covered with ice</p>	<p>Clean the sensor and its surrounding area on the bumper.</p>

Warning message	Details	Correction procedure
	Indicates that remaining fuel is approximately 2.8 gal. (10.5 L, 2.3 Imp.gal.) or less	Refuel the vehicle.
  (Flashes)	Indicates that the engine switch is turned off or turned to ACCESSORY mode and the driver's door is opened while the lights are turned on	Turn the lights off.
  (Flashes)	Indicates that the driver's door was opened with the shift position in any position other than P	Shift the shift position to P.

تلفن شبانه روزی: ۰۲۱ ۸۸۸۶۲۰۸۵

FarmaSOS.com

**■ Warning message in radar cruise mode (if equipped)**

In the following cases, the warning message may not be displayed even if vehicle-to-vehicle distance decreases:

- When your vehicle and the vehicle ahead are traveling at the same speed or the vehicle ahead is traveling more quickly than your vehicle
- When the vehicle ahead is traveling at a very low speed
- Immediately after cruise control speed is set
- At the instant the accelerator pedal is depressed

**■ The LKA (Lane-Keeping Assist) lane departure warning function**

In the following cases, the warning message will not be displayed even if a lane line is crossed.



- When the vehicle speed deviates from the operating range of the LKA system functions
- When the lane lines cannot be recognized
- When the steering wheel is turned as far as necessary to cause the vehicle to change lanes





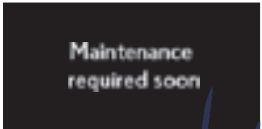

تلفن شبانه روزی: ۰۲۱-۸۸۶۲۰۸۵

FarmaSOS.com

### Follow the correction procedures.

A warning message is shown on the multi-information display. After taking the specified steps to correct the suspected problem, check that the warning message goes off.

Warning message	Details	Correction procedure
	Indicates that the washer fluid level is low	Add washer fluid.
  (U.S.A. only)	Indicates that all maintenance according to the driven distance on the maintenance schedule* should be performed soon. Comes on approximately 4500 miles (7200 km) after the maintenance data has been reset.	If necessary, perform maintenance.

Warning message	Details	Correction procedure
 <p>Maintenance required</p>  <p>(U.S.A. only)</p>	<p>Indicates that all maintenance is required to correspond to the driven distance on the maintenance schedule*.</p> <p>Comes on approximately 5000 miles (8000 km) after the maintenance data has been reset. (The indicator will not work properly unless the maintenance data has been reset.)</p>	<p>Perform the necessary maintenance. Please reset the maintenance data after the maintenance is performed (→P.602)</p>
 <p>TIRE PRESSURE [psi] 33.0 33.0</p>  <p>(If equipped)</p>	<p>Indicates that the tire inflation pressure is low</p>	<p>Check the tire inflation pressure, and adjust to the appropriate level.</p>
 <p>TIRE PRESSURE [psi] --- --- --- ---</p>  <p>(If equipped)</p>	<p>Indicates a malfunction in the tire pressure warning system</p>	<p>Stop the vehicle in a safe place and turn the engine switch off then on again. If the tire pressure warning indicator flashes for 1 minute then illuminates, there is a malfunction in the system. Have the vehicle inspected at your Lexus dealer.</p>

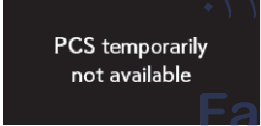



Warning message	Details	Correction procedure
 <p>(If equipped)</p>	<p>Indicates that the tire position information cannot be recognized</p>	<p>Drive for a short while and check if the display updates.</p> <p>If the radio wave conditions improve, the display may return to normal. If the tire pressure is still not displayed after driving for several minutes, stop the vehicle in a safe place, turn the engine switch off then on again, and start driving.</p> <p>If the tire pressure is still not displayed even after repeating this several times, have the vehicle inspected at your Lexus dealer.</p>
 <p><b>PCS</b> (Flashes) (If equipped)</p>	<p>Indicates that the pre-collision system is not currently functional because the grille cover or the sensor is dirty</p> <p>This message also appears when the pre-collision system is not functional due to overheating.</p>	<p>Check the grille cover and the sensor and clean them if they are dirty.</p> <p>In case of overheating, the system will become functional once the system cools down.</p>







\*: Refer to the separate "Scheduled Maintenance" or "Owner's Manual Supplement" for the maintenance interval applicable to your vehicle.



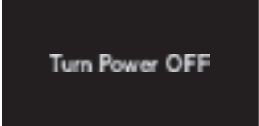







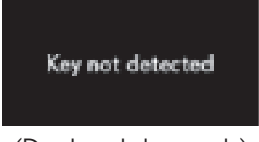

## Have the malfunction repaired immediately.



After taking the specified steps to correct the suspected problem, check that the warning message and light go off.

Interior buzzer	Exterior buzzer	Warning message	Details	Correction procedure
Once	—	  (Flashes)	The electronic key is not detected when an attempt is made to start the engine.	Start the engine with the electronic key present.
Once	3 times	  (Flashes)	<p>The electronic key was carried outside the vehicle and a door other than the driver's door was opened and closed while the engine switch was in a mode other than off.</p> <p>The driver's door was opened and closed while the electronic key was not in the vehicle, the shift lever was in P and the engine switch was not turned off.</p>	<p>Bring the electronic key back into the vehicle.</p> <p>Turn the engine switch off or bring the electronic key back into the vehicle.</p>







Interior buzzer	Exterior buzzer	Warning message	Details	Correction procedure
Once	Continuous	  (Displayed alternately)  (Flashes)	An attempt was made to exit the vehicle with the electronic key and lock the doors without first turning the engine switch off when the shift lever was in P.	Turn the engine switch off and lock the doors again.
9 times	—	  (Flashes)	An attempt was made to drive when the regular key was not inside the vehicle.	Confirm that the electronic key is inside the vehicle.
Continuous	—	  (Flashes)	The driver's door was opened when the shift lever was not in P and the engine switch was not turned off.	Shift the shift lever to P.

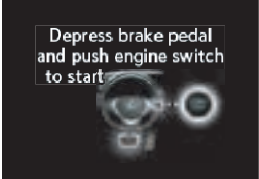

Interior buzzer	Exterior buzzer	Warning message	Details	Correction procedure
Continuous	Continuous	  (Displayed alternately)  (Flashes)	The driver's door was opened and closed while the electronic key was not in the vehicle, the shift lever was not in P and the engine switch was not turned off.	<ul style="list-style-type: none"> <li>• Shift the shift lever to P.</li> <li>• Bring the electronic key back into the vehicle.</li> </ul>
—	Continuous	  (Flashes)	An attempt was made to lock the doors using the smart access system with push-button start while the electronic key was still inside the vehicle.	Retrieve the electronic key from the vehicle and lock the doors again.
Once	Continuous	  (Flashes)	An attempt was made to lock either front door by opening a door and putting the inside lock button into the lock position, then closing the door with the electronic key still inside the vehicle.	Retrieve the electronic key from the vehicle and lock the doors again.

Interior buzzer	Exterior buzzer	Warning message	Details	Correction procedure
Once	—	  (Flashes)	<ul style="list-style-type: none"> <li>• When the doors were unlocked with the mechanical key and then the engine switch was pressed, the electronic key could not be detected in the vehicle.</li> <li>• The electronic key could not be detected in the vehicle even after the engine switch was pressed two consecutive times.</li> </ul>	Touch the electronic key to the engine switch while depressing the brake pedal.
Once	—	  (Flashes)	An attempt was made to start the engine with the shift lever in an incorrect position.	Shift the shift lever to P and start the engine.

Interior buzzer	Exterior buzzer	Warning message	Details	Correction procedure
—	—		Power was turned off due to the automatic power off function.	Next time when starting the engine, increase the engine speed slightly and maintain that level for approximately 5 minutes to recharge the battery.
Once	—		The electronic key has a low battery.	Replace the electronic key battery. (→P.646)

FarmaSOS.com

Interior buzzer	Exterior buzzer	Warning message	Details	Correction procedure
Once	—	  (Flashes)	<p>The driver's door was opened and closed with the engine switch turned off and then the engine switch was put in ACCESSORY mode twice without the engine being started.</p>	<p>Press the engine switch while depressing the brake pedal.</p>
			<p>During an engine starting procedure in the event that the electronic key was not functioning properly (→P. 741), the engine switch was touched with the electronic key.</p>	<p>Press the engine switch within 10 seconds of the buzzer sounding.</p>
Once	—	<p>تلفن شبانه روزی: ۰۲۱-۸۸۶۲۰۸۵</p>   (Flashes)	<p>The steering lock could not be released within 3 seconds of the engine switch being pressed.</p>	<p>Press the engine switch while depressing the brake pedal and moving the steering wheel left and right.</p>
Once	—	  (Flashes)	<p>The engine switch has been turned off with the shift lever in a position other than P or N.</p>	<p>Shift the shift lever to P.</p>

Interior buzzer	Exterior buzzer	Warning message	Details	Correction procedure
Once	—	  (Flashes)	After the engine switch has been turned off with the shift lever in a position other than P, the shift lever has been shifted to P.	Turn the engine switch off.

### ■ Warning buzzer

In some cases, the buzzer may not be heard because of noisy place or an audio sound.

امداد خودرو فارما

تلفن شبانه روزی: ۰۲۱-۸۸۶۲۰۸۵

FarmaSOS.com

## If you have a flat tire

Remove the flat tire and replace it with the spare tire provided.

For details about tires: →P. 629

### CAUTION

#### ■ If you have a flat tire

Do not continue driving with a flat tire.

Driving even a short distance with a flat tire can damage the tire and the wheel beyond repair, which could result in an accident.

### Before jacking up the vehicle

- Stop the vehicle on a hard, flat surface.
- Set the parking brake.
- Shift the shift lever to P.
- Stop the engine. • ۲۱-۸۸۶۲۰۸۵: تلفن شبانه روزی
- Turn on the emergency flashers. (→P. 676)

FarmaSOS.com



## Location of the spare tire, jack and tools

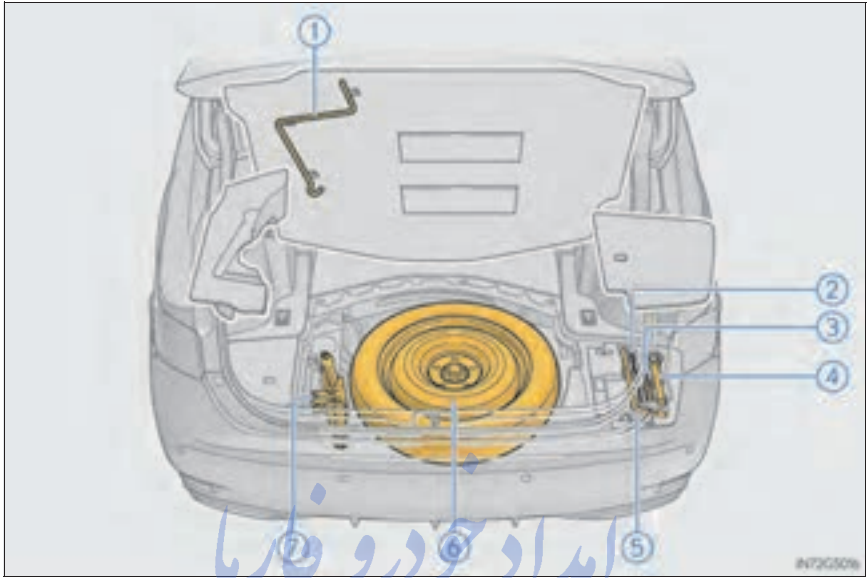

- |                              |                    |
|------------------------------|--------------------|
| ① Jack handle                | ⑤ Wheel nut wrench |
| ② Parking brake release tool | ⑥ Spare tire       |
| ③ Screwdriver                | ⑦ Jack             |
| ④ Towing eyelet              |                    |

FarmaSOS.com

**⚠ CAUTION****■ Using the tire jack**

Observe the following precautions.

Improper use of the tire jack may cause the vehicle to suddenly fall off the jack, leading to death or serious injury.

- Do not use the tire jack for any purpose other than replacing tires or installing and removing tire chains.
- Only use the tire jack that comes with this vehicle for replacing a flat tire. Do not use it on other vehicles, and do not use other tire jacks for replacing tires on this vehicle.
- Put the jack properly in its jack point.
- Do not put any part of your body under the vehicle while it is supported by the jack.
- Do not start the engine or drive the vehicle while the vehicle is supported by the jack.
- Do not raise the vehicle while someone is inside.
- When raising the vehicle, do not put an object on or under the jack.
- Do not raise the vehicle to a height greater than that required to replace the tire.
- Use a jack stand if it is necessary to get under the vehicle.
- When lowering the vehicle, make sure that there is no-one near the vehicle. If there are people nearby, warn them vocally before lowering.

### Taking out the jack and jack handle

- 1 Remove the center luggage mat. (→P. 559)
- 2 Remove the spacer and take out the jack handle from the reverse side of the center luggage mat.

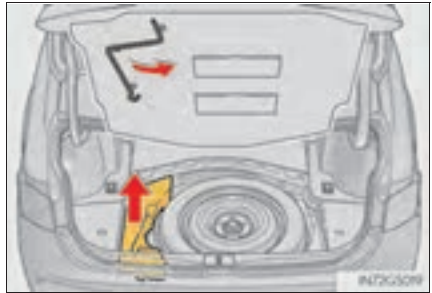

- 3 Take out the jack.
  - 1 For tightening
  - 2 For loosening



تلفن شبانه روزی: ۰۲۱-۸۸۶۲۰۸۵

FarmaSOS.com

### Taking out the spare tire

- 1 Remove the center luggage mat. (→P. 559)
- 2 Loosen the center fastener that secures the spare tire.



### ⚠ CAUTION

#### ■ When storing the spare tire

Be careful not to catch fingers or other body parts between the spare tire and the body of the vehicle.

تلفن شبانه روزی: ۰۲۱-۸۸۶۲۰۸۵

FarmaSOS.com

## Replacing a flat tire

- 1 Check the tires.

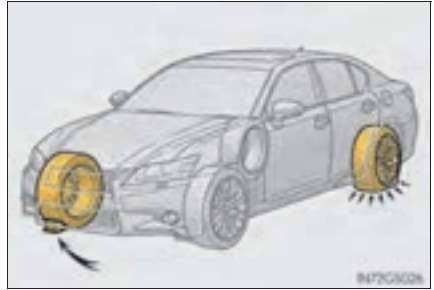

Flat tire		Wheel chock positions
Front	Left-hand side	Behind the rear right-hand side tire
	Right-hand side	Behind the rear left-hand side tire
Rear	Left-hand side	In front of the front right-hand side tire
	Right-hand side	In front of the front left-hand side tire

- 2 Slightly loosen the wheel nuts (one turn).

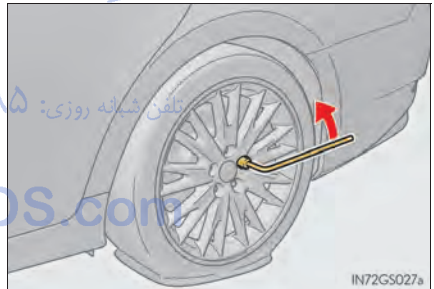

- 3 Turn the tire jack portion "A" by hand until the notch of the jack is in contact with the jack point.

The jack point guides are located under the rocker panel. They indicate the jack point positions.

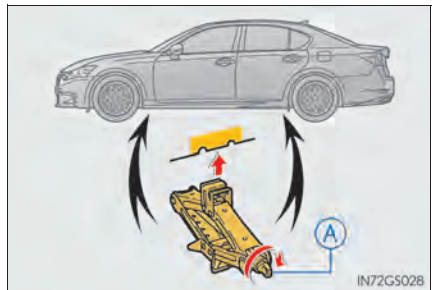

- 4 Raise the vehicle until the tire is slightly raised off the ground.



- 5 Remove all the wheel nuts and the tire.

When resting the tire on the ground, place the tire so that the wheel design faces up to avoid scratching the wheel surface.

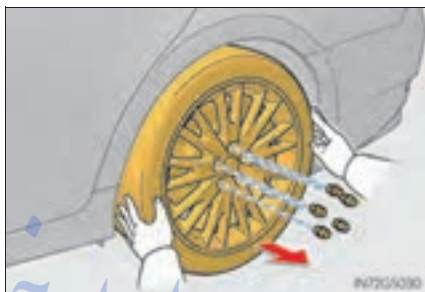

امداد خودرو فارما

تلفن شبانه روزی: ۰۲۱-۸۸۶۲۰۸۵

FarmaSOS.com

 CAUTION**■ Replacing a flat tire**

- Do not touch the disc wheels or the area around the brakes immediately after the vehicle has been driven.  
After the vehicle has been driven the disc wheels and the area around the brakes will be extremely hot. Touching these areas with hands, feet or other body parts while changing a tire, etc. may result in burns.
- Failure to follow these precautions could cause the wheel nuts to loosen and the tire to fall off, resulting in death or serious injury.
  - Never use oil or grease on the wheel bolts or wheel nuts.  
Oil and grease may cause the wheel nuts to be excessively tightened, leading to bolt or disc wheel damage. In addition, the oil or grease can cause the wheel nuts to loosen and the wheel may fall off, causing a serious accident. Remove any oil or grease from the wheel bolts or wheel nuts.
  - Have the wheel nuts tightened with a torque wrench to 76 ft•lbf (103 N•m, 10.5 kgf•m) as soon as possible after changing wheels.
  - When installing a tire, only use wheel nuts that have been specifically designed for that wheel.
  - If there are any cracks or deformations in the bolt screws, nut threads or bolt holes of the wheel, have the vehicle inspected by your Lexus dealer.

تلفن شبانه روزی: ۰۲۱-۸۸۶۲۰۸۵

FarmaSOS.com

## Installing the spare tire

- 1 Remove any dirt or foreign matter from the wheel contact surface.

If foreign matter is on the wheel contact surface, the wheel nuts may loosen while the vehicle is in motion, causing the tire to come off.



- 2 Install the spare tire and loosely tighten each wheel nut by hand by approximately the same amount.

When replacing an aluminum wheel with a steel wheel, tighten the wheel nuts until the tapered portion comes into loose contact with the disc wheel seat.

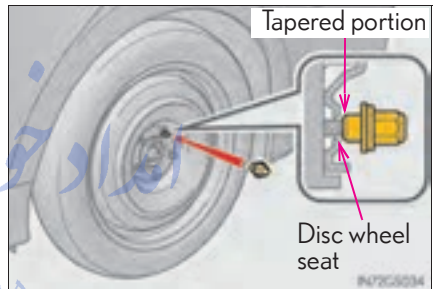

When replacing an aluminum wheel with an aluminum wheel, turn the wheel nuts until the washers come into contact with the disc wheel.

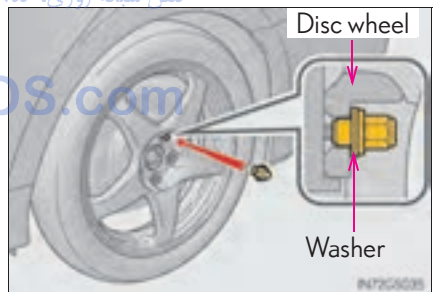



- 3 Lower the vehicle.



- 4 Firmly tighten each wheel nut two or three times in the order shown in the illustration.

**Tightening torque:**

76 ft•lbf (103 N•m, 10.5 kgf•m)



- 5 Stow the flat tire, tire jack and all tools.

تلفن شبانه روزی: ۰۲۱-۸۸۶۲۰۸۵

FarmaSOS.com

### ■ The compact spare tire

- The compact spare tire is identified by the label "TEMPORARY USE ONLY" on the tire sidewall.  
Use the compact spare tire temporarily, and only in an emergency.
- Make sure to check the tire inflation pressure of the compact spare tire.  
(→P. 759)

### ■ When using the compact spare tire

As the compact spare tire is not equipped with a tire pressure warning valve and transmitter, low inflation pressure of the spare tire will not be indicated by the tire pressure warning system. Also, if you replace the compact spare tire after the tire pressure warning light comes on, the light remains on.

### ■ When the compact spare tire is equipped

The vehicle becomes lower when driving with the compact spare tire compared to when driving with standard tires.

### ■ If you have a flat rear tire on a road covered with snow or ice (vehicles with front and rear tires of the same size)

Install the compact spare tire on one of the front wheels of the vehicle. Perform the following steps and fit tire chains to the rear tires:

- 1 Replace a front tire with the compact spare tire.
- 2 Replace the flat rear tire with the tire removed from the front of the vehicle.
- 3 Fit tire chains to the rear tires.

## ⚠ CAUTION

### ■ When using the compact spare tire

- Remember that the compact spare tire provided is specifically designed for use with your vehicle. Do not use your compact spare tire on another vehicle.
- Do not use more than one compact spare tires simultaneously.
- Replace the compact spare tire with a standard tire as soon as possible.
- Avoid sudden acceleration, abrupt steering, as well as sudden braking and shifting operation to engine braking.

### ■ When the compact spare tire is attached

The vehicle speed may not be correctly detected, and the following systems may not operate correctly:

- |   |  |
|---|--|
| • ABS & Brake assist                            | • DRS (if equipped)                          |
| • VSC   | • AVS (if equipped)                          |
| • TRAC  | • LKA (Lane-Keeping Assist)<br>(if equipped) |
| • Cruise control                                | • VGRS (if equipped)                         |
| • Dynamic radar cruise control<br>(if equipped) | • Rear view monitor system                   |
| • PCS (if equipped)                             | • Intuitive parking assist (if equipped)     |
| • EPS   | • Navigation system (if equipped)            |
| • AFS (if equipped)                             |  |
| • LDH (if equipped)                             |  |

Also, not only can the following system not be utilized fully, but it may even negatively affect the drive-train components:

- AWD system

 CAUTION**■ Speed limit when using the compact spare tire**

Do not drive at speeds in excess of 50 mph (80 km/h) when a compact spare tire is installed on the vehicle.

The compact spare tire is not designed for driving at high speeds. Failure to observe this precaution may lead to an accident causing death or serious injury.

**■ After using the tools and jack**

Before driving, make sure all the tools and jack are securely in place in their storage location to reduce the possibility of personal injury during a collision or sudden braking.

 NOTICE**■ Driving with tire chains and the compact spare tire**

Do not fit tire chains to the compact spare tire.

Tire chains may damage the vehicle body and adversely affect driving performance.

**■ When replacing the tires**

When removing or fitting the wheels, tires or the tire pressure warning valve and transmitter, contact your Lexus dealer as the tire pressure warning valve and transmitter may be damaged if not handled correctly.

## If the engine will not start

If the engine will not start even though correct starting procedures are being followed (→P. 154), consider each of the following points:

### The engine will not start even though the starter motor operates normally.

One of the following may be the cause of the problem:

- There may not be sufficient fuel in the vehicle's tank.  
Refuel the vehicle.
- The engine may be flooded.  
Try to restart the engine again following correct starting procedures.  
(→P. 154)
- There may be a malfunction in the engine immobilizer system.  
(→P. 68)

### The starter motor turns over slowly, the interior lights and headlights are dim, or the horn does not sound or sounds at a low volume.

One of the following may be the cause of the problem:

- The battery may be discharged. (→P. 743)
- The battery terminal connections may be loose or corroded.

### The starter motor does not turn over

The engine starting system may be malfunctioning due to an electrical problem such as electronic key battery depletion or a blown fuse. However, an interim measure is available to start the engine. (→P. 736)

**The starter motor does not turn over, the interior lights and headlights do not turn on, or the horn does not sound.**

One of the following may be the cause of the problem:

- One or both of the battery terminals may be disconnected.
- The battery may be discharged. (→P. 743)
- There may be a malfunction in the steering lock system.

Contact your Lexus dealer if the problem cannot be repaired, or if repair procedures are unknown.

### Emergency start function

When the engine does not start, the following steps can be used as an interim measure to start the engine if the engine switch is functioning normally:

- 1** Set the parking brake.
- 2** Shift the shift lever to P.
- 3** Turn the engine switch to ACCESSORY mode.
- 4** Press and hold the engine switch for about 15 seconds while depressing the brake pedal firmly.

Even if the engine can be started using the above steps, the system may be malfunctioning. Have the vehicle inspected by your Lexus dealer.

## If the shift lever cannot be shifted from P

If the shift lever cannot be shifted with your foot on the brake pedal, there may be a problem with the shift lock system (a system to prevent accidental operation of the shift lever). Have the vehicle inspected by your Lexus dealer immediately.

The following steps may be used as an emergency measure to ensure that the shift lever can be shifted:

- 1 Set the parking brake.
- 2 Turn the engine switch to ACCESSORY mode.
- 3 Depress the brake pedal.
- 4 Pry the cover up with a flathead screwdriver or equivalent tool.

To prevent damage to the cover, cover the tip of the screwdriver with a rag.

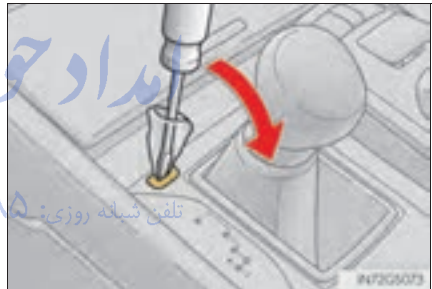

- 5 Press the shift lock override button.

The shift lever can be shifted while the button is pressed.

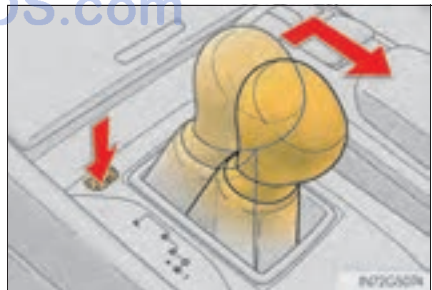

## If the parking brake cannot be released

In the event that the battery is discharged or switch operation does not release the parking brake, the parking brake can be released manually using the procedure below. This procedure should be performed only if necessary, such as in an emergency.

If the switch cannot be operated even when the battery is normal, the parking brake system may be malfunctioning. Have the vehicle inspected by your Lexus dealer immediately.

### Before releasing the parking brake manually

- Shift the shift lever to P.
- Turn the engine switch off.
- Check that the parking brake indicator is off.
- Check the tires.

### Releasing the parking brake manually

- 1** Take out the parking brake release tool and the screwdriver from the trunk. (→P. 723)

Fit the parking brake release tool into the screwdriver handle.



- 2** Take out the spare tire. (→P. 722)



- 3 Remove the plug.



- 4 Insert the tool and press it down firmly while turning it counter-clockwise until it stops.

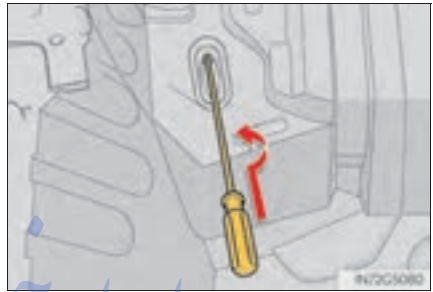

امداد خودرو فارما

#### Manual operation of the parking brake

The parking brake cannot be set manually.

تلفن شماره بوزنت: ۰۲۱-۸۸۶۲۰۸۵

#### CAUTION

##### When releasing the parking brake manually

- Shift the shift lever to P, turn the engine switch off and chock the tires. Failure to do so may cause the vehicle to move, resulting in an accident.
- Turn the engine switch off and check that the parking brake indicator is off. Failure to do so may cause the system to operate and turn the inserted parking brake release tool, resulting in an injury.

## If the electronic key does not operate properly

If communication between the electronic key and vehicle is interrupted (→P. 108) or the electronic key cannot be used because the battery is depleted, the smart access system with push-button start and wireless remote control cannot be used. In such cases, the doors and trunk can be opened and the engine can be started by following the procedure below.

### Locking and unlocking the doors, unlocking the trunk and key linked functions

#### ■ Doors

Use the mechanical key (→P. 98) in order to perform the following operations:

- ① Locks all the doors
- ② Closes the windows and moon roof\* (turn and hold)
- ③ Unlocks the door  
Turning the key rearward unlocks the driver's door. Turning the key once again within 5 seconds unlocks the other doors.
- ④ Opens the windows and moon roof\* (turn and hold)

\*: This setting must be customized at your Lexus dealer.



## ■ Trunk

Turn the mechanical key clockwise to open.

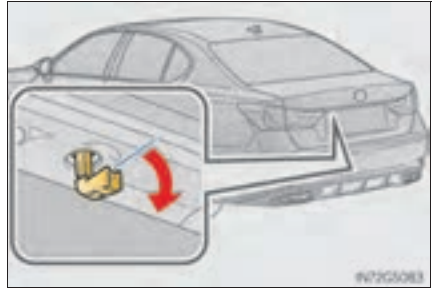



## Starting the engine

- 1 Ensure that the shift lever is in P and depress the brake pedal.
- 2 Touch the Lexus emblem side of the electronic key to the engine switch.

The engine switch will turn to IGNITION ON mode.

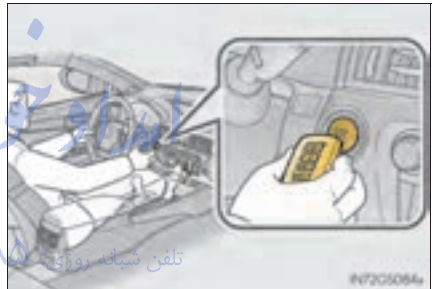
When the smart access system with push-button start is deactivated in customization setting, the engine switch will turn to ACCESSORY mode.



- 3 Firmly depress the brake pedal and check that  is shown on the multi-information display.
- 4 Press the engine switch.

In the event that the engine still cannot be started, contact your Lexus dealer.

**■ Stopping the engine**

Shift the shift lever to P and press the engine switch as you normally do when stopping the engine.

**■ Replacing the key battery**

As the above procedure is a temporary measure, it is recommended that the electronic key battery be replaced immediately when the battery is depleted. (→P. 646)

**■ Changing engine switch modes**

Release the brake pedal and press the engine switch in step **3** above.

The engine does not start and modes will be changed each time the switch is pressed.(→P. 172)

**■ When the electronic key does not work properly**

- Make sure that the smart access system with push-button start has not been deactivated in the customization setting. If it is off, turn the function on. (Customizable features →P. 777)
- Check if battery-saving mode is set. If it is set, cancel the function. (→P. 107)

امداد خودرو فارما

تلفن شبانه روزی: ۰۲۱-۸۸۶۲۰۸۵

FarmaSOS.com

## If the vehicle battery is discharged

The following procedures may be used to start the engine if the vehicle's battery is discharged.

You can also call your Lexus dealer or a qualified repair shop.

If you have a set of jumper (or booster) cables and a second vehicle with a 12-volt battery, you can jump start your vehicle by following the steps below.

- 1 Open the hood (→P. 612)
- 2 Connect the jumper cables according to the following procedure:

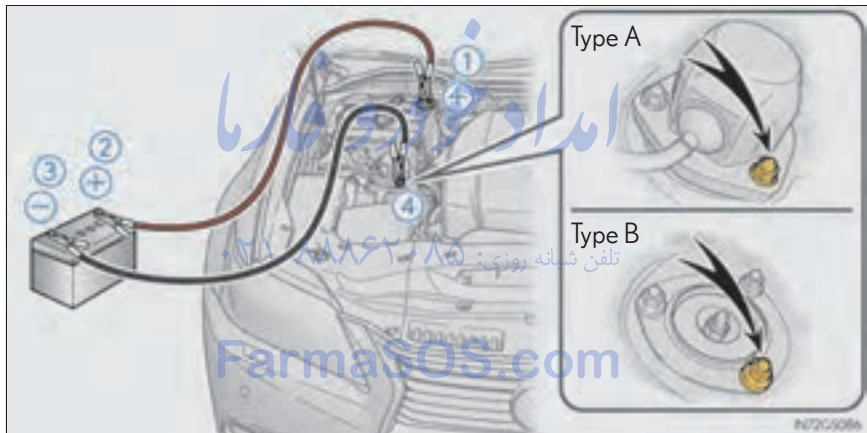

- 1 Connect a positive jumper cable clamp to the positive (+) battery terminal on your vehicle.
- 2 Connect the clamp on the other end of the positive cable to the positive (+) battery terminal on the second vehicle.
- 3 Connect a negative cable clamp to the negative (-) battery terminal on the second vehicle.
- 4 Connect the clamp at the other end of the negative cable to a solid, stationary, unpainted metallic point away from the battery and any moving parts, as shown in the illustration.

- 3 Start the engine of the second vehicle. Increase the engine speed slightly and maintain at that level for approximately 5 minutes to recharge the battery of your vehicle.
- 4 Open and close any of the doors of your vehicle with the engine switch off.
- 5 Maintain the engine speed of the second vehicle and start the engine of your vehicle by turning the engine switch to IGNITION ON mode.
- 6 Once the vehicle's engine has started, remove the jumper cables in the exact reverse order from which they were connected.

Once the engine starts, have the vehicle inspected at your Lexus dealer as soon as possible.

امداد خودرو فارما

تلفن شبانه روزی: ۰۲۱-۸۸۸۶۲۰۸۵

FarmaSOS.com

**■ Starting the engine when the battery is discharged**

The engine cannot be started by push-starting.

**■ To prevent battery discharge**

- Turn off the headlights and the audio system while the engine is off.
- Turn off any unnecessary electrical components when the vehicle is running at a low speed for an extended period, such as in heavy traffic.

**■ Charging the battery**

The electricity stored in the battery will discharge gradually even when the vehicle is not in use, due to natural discharge and the draining effects of certain electrical appliances. If the vehicle is left for a long time, the battery may discharge, and the engine may be unable to start. (The battery recharges automatically during driving.)

**■ When recharging or replacing the battery**

- Make sure the key is not inside the vehicle when recharging or replacing the battery to prevent the doors from being locked with the key left inside the vehicle when the alarm operates.
- In some cases, it may not be possible to unlock the doors using the smart access system with push-button start when the battery is discharged. Use the wireless remote control or the mechanical key to lock or unlock the doors.
- The engine may not start on the first attempt after the battery has recharged but will start normally after the second attempt. This is not a malfunction.
- The engine switch mode is memorized by the vehicle. When the battery is reconnected, the system will return to the mode it was in before the battery was discharged. Before disconnecting the battery, turn the engine switch off. If you are unsure what mode the engine switch was in before the battery discharged, be especially careful when reconnecting the battery.

 CAUTION**■ Avoiding battery fires or explosions**

Observe the following precautions to prevent accidentally igniting the flammable gas that may be emitted from the battery:

- Make sure each jumper cable is connected to the correct terminal and that it is not unintentionally in contact with any other than the intended terminal.
- Do not allow the other end of the jumper cable connected to the “+” terminal to come into contact with any other parts or metal surfaces in the area, such as brackets or unpainted metal.
- Do not allow the + and - clamps of the jumper cables to come into contact with each other.
- Do not smoke, use matches, cigarette lighters or allow open flame near the battery.

**■ Battery precautions**

The battery contains poisonous and corrosive acidic electrolyte, while related parts contain lead and lead compounds. Observe the following precautions when handling the battery:

- When working with the battery, always wear safety glasses and take care not to allow any battery fluids (acid) to come into contact with skin, clothing or the vehicle body.
- Do not lean over the battery.
- In the event that battery fluid comes into contact with the skin or eyes, immediately wash the affected area with water and seek medical attention. Place a wet sponge or cloth over the affected area until medical attention can be received.
- Always wash your hands after handling the battery support, terminals, and other battery-related parts.
- Do not allow children near the battery.

 NOTICE**■ When handling jumper cables**

When connecting the jumper cables, ensure that they do not become entangled in the cooling fans or engine drive belt.



## If your vehicle overheats

- 1 Stop the vehicle in a safe place and turn off the air conditioning system.
- 2 Check to see if steam is coming out from under the hood.

If you see steam:

Stop the engine. Carefully lift the hood after the steam subsides and then restart the engine.

If you do not see steam:

Leave the engine running and carefully lift the hood.

- 3 Check to see if the cooling fan is operating.

If the fan is operating:

Wait until the temperature of the engine (shown on the instrument panel) begins to fall and then stop the engine.

If the fan is not operating:

Stop the engine immediately and call your Lexus dealer.

- 4 After the engine has cooled down sufficiently, check the engine coolant level and inspect the radiator core (radiator) for any leaks.

If the engine compartment cover needs to be removed: →P. 616

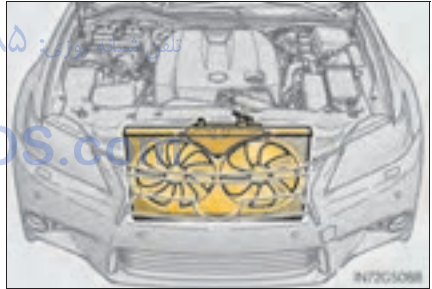

- 5 Add engine coolant if necessary.

Water can be used in an emergency if engine coolant is unavailable.  
(→P. 756)



Have the vehicle inspected at the nearest Lexus dealer as soon as possible.

### ■ Overheating

If you observe the following, your vehicle may be overheating:

- The engine coolant temperature gauge enters the red zone or a loss of power is experienced.
- Steam comes out from under the hood.

### ⚠ CAUTION

#### ■ When inspecting under the hood of your vehicle

Observe the following precautions.

Failure to do so may result in serious injury such as burns.

- If steam is seen coming from under the hood, do not open the hood until the steam has subsided. The engine compartment may be very hot.
- Keep hands and clothing away from the fans, etc. while the engine is operating.
- Do not loosen the radiator cap while the engine and radiator are hot. High temperature steam or coolant could spray out.



تلفن شماره روزی: ۰۲۱-۸۸۶۲۰۸۵

FarmaSOS.com

### ⚠ NOTICE

#### ■ When adding engine coolant

Add coolant slowly after the engine has cooled down sufficiently. Adding cool coolant to a hot engine too quickly can cause damage to the engine.

#### ■ To prevent damage to the cooling system

Observe the following precautions:

- Avoid contaminating the coolant with foreign matter (such as sand or dust etc.).
- Do not use commercially available coolant additives.

## If the vehicle becomes stuck

Carry out the following procedures if the tires spin or the vehicle becomes stuck in mud, dirt or snow:

- 1 Stop the engine. Set the parking brake and shift the shift lever to P.
- 2 Remove the mud, snow or sand from around the rear wheels.
- 3 Place wood, stones or some other material under the rear wheels to help provide traction.
- 4 Restart the engine.
- 5 Shift the shift lever to D or R and release the parking brake. Then, while exercising caution, depress the accelerator pedal.

### ■ When it is difficult to free the vehicle

Press  to turn off TRAC.

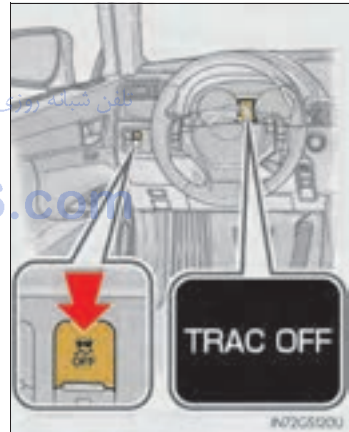

 CAUTION**■ When attempting to free a stuck vehicle**

If you choose to push the vehicle back and forth to free it, make sure the surrounding area is clear to avoid striking other vehicles, objects or people. The vehicle may also lunge forward or lunge back suddenly as it becomes free. Use extreme caution.

**■ When shifting the shift lever**

Be careful not to shift the shift lever with the accelerator pedal depressed. This may lead to unexpected rapid acceleration of the vehicle that may cause an accident resulting in death or serious injury.

 NOTICE**■ To avoid damaging the transmission and other components**

- Avoid spinning the rear wheels and depressing the accelerator pedal more than necessary.
- If the vehicle remains stuck even after these procedures are performed, the vehicle may require towing to be freed.

تلفن شبانه روزی: ۰۲۱-۸۸۶۲۰۸۵

FarmaSOS.com

**8-1. Specifications**

Maintenance data (fuel, oil level, etc.).....	752
Fuel information.....	762
Tire information.....	765

**8-2. Customization**

Customizable features .....	777
-----------------------------	-----

**8-3. Items to initialize**

Items to initialize .....	788
---------------------------	-----

امداد خودرو فارما

تلفن شبانه روزی: ۰۲۱-۸۸۸۶۲۰۸۵

[FarmaSOS.com](http://FarmaSOS.com)

## Maintenance data (fuel, oil level, etc.)

### Dimensions and weight

Overall length		190.7 in. (4845mm)
Overall width		72.4 in. (1840 mm)
Overall height* <sup>1</sup>	2WD	57.3 in. (1455 mm)
	AWD	57.9 in. (1470 mm)
Wheelbase		112.2 in. (2850 mm)
Tread* <sup>1</sup>	Front	62.0 in. (1575 mm)
	Rear	62.6 in. (1590 mm) 61.4 in. (1560 mm)* <sup>2</sup>
Vehicle capacity weight (Occupants + luggage)		825 lb. (370 kg)

\*<sup>1</sup>: Unladen vehicle

\*<sup>2</sup>: Vehicles with 265/35R19 tires

تلفن شبانه روزی: ۰۲۱-۸۸۶۲۰۸۵

FarmaSOS.com

## Vehicle identification

### ■ Vehicle identification number

The vehicle identification number (VIN) is the legal identifier for your vehicle. This is the primary identification number for your Lexus. It is used in registering the ownership of your vehicle.

This number is stamped on the top left of the instrument panel and in the engine compartment.

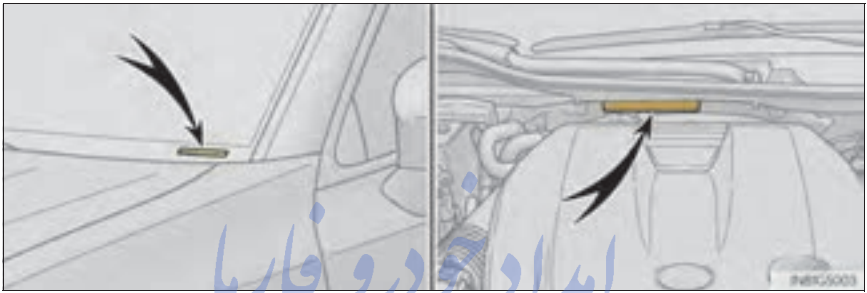

This number is also on the Certification Label.



### ■ Engine number

The engine number is stamped on the engine block as shown.

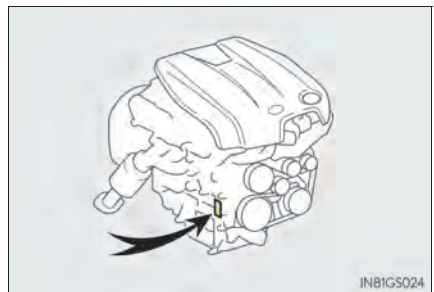

## Engine

Model	3.5L 6-cylinder (2GR-FSE)
Type	6-cylinder V type, 4-cycle, gasoline
Bore and stroke	3.70 × 3.27 in. (94.0 × 83.0 mm)
Displacement	210.9 cu.in. (3456 cm <sup>3</sup> )
Valve clearance (engine cold)	Automatic adjustment
Drive belt tension	Automatic adjustment

## Fuel

Fuel type	Premium unleaded gasoline only
Octane Rating	91 (Research Octane Number 96) or higher
Fuel tank capacity (Reference)	17.5 gal. (66.3 L, 14.6 Imp.gal.)

## Lubrication system

	2WD	AWD
Oil capacity Drain and refill (Reference*)		
With filter	6.7 qt. (6.3 L, 5.5 Imp.qt.)	6.8 qt. (6.4 L, 5.6 Imp.qt.)
Without filter	6.2 qt. (5.9 L, 5.2 Imp.qt.)	6.3 qt. (6.0 L, 5.3 Imp.qt.)

\*: The engine oil capacity is a reference quantity to be used when changing the engine oil. Warm up and turn off the engine, wait more than 5 minutes, and check the oil level on the dipstick.



## ■ Engine oil selection

“Toyota Genuine Motor Oil” is used in your Lexus vehicle. Use Lexus approved “Toyota Genuine Motor Oil” or equivalent to satisfy the following grade and viscosity.

Oil grade: ILSAC GF-5 multigrade engine oil

Recommended viscosity: SAE 0W-20

SAE 0W-20 is the best choice for good fuel economy and good starting in cold weather.

If SAE 0W-20 is not available, SAE 5W-20 oil may be used. However, it must be replaced with SAE 0W-20 at the next oil change.

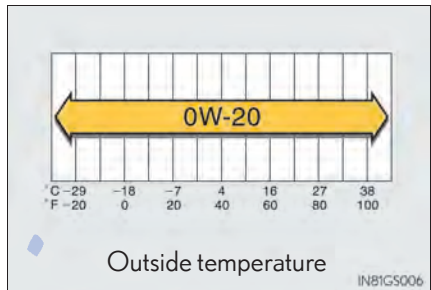

Oil viscosity (0W-20 is explained here as an example):

- The 0W in 0W-20 indicates the characteristic of the oil which allows cold startability. Oils with a lower value before the W allow for easier starting of the engine in cold weather.
- The 20 in 0W-20 indicates the viscosity characteristic of the oil when the oil is at high temperature. An oil with a higher viscosity (one with a higher value) may be better suited if the vehicle is operated at high speeds, or under extreme load conditions.

How to read oil container label:

The ILSAC (International Lubricant Standardization and Approval Committee) Certification Mark is added to some oil containers to help you select the oil you should use.



## Cooling system

Capacity	10.3 qt. (9.7 L, 8.5 Imp.qt.)
Coolant type	<p>Use either of the following:</p> <ul style="list-style-type: none"> <li>• “Toyota Super Long Life Coolant”</li> <li>• Similar high-quality ethylene glycol-based non-silicate, non-amine, non-nitrite, and non-borate coolant with long-life hybrid organic acid technology</li> </ul> <p>Do not use plain water alone.</p>

## Ignition system

Spark plug	
Make	DENSO FK20HBR11
Gap	0.043 in. (1.1 mm)

### NOTICE

#### ■ Iridium-tipped spark plugs

Use only iridium-tipped spark plugs. Do not adjust the spark plug gap.

## Electrical system

Battery	
Open voltage at 68 °F (20 °C):	12.6 — 12.8 V Fully charged 12.2 — 12.4 V Half charged 11.8 — 12.0 V Discharged (Voltage is checked 20 minutes after the engine and all lights are turned off.)
Specific gravity reading at 68 °F (20 °C):	1.250 — 1.290 Fully charged 1.160 — 1.200 Half charged 1.060 — 1.100 Discharged
Charging rates	
Quick charge	15 A max.
Slow charge	5 A max.

## Automatic transmission

Fluid capacity *	2WD	8.3 qt. (7.9 L, 7.0 Imp.qt.)
	AWD	10.6 qt. (10.0 L, 8.8 Imp.qt.)
Fluid type	Toyota Genuine ATF WS تلفن ش ۰۲۱-۸۸۳۰۸۸	

\*: The fluid capacity is the quantity of reference.

If replacement is necessary, contact your Lexus dealer.

### NOTICE

#### ■ Automatic transmission fluid type

Using transmission fluid other than “Toyota Genuine ATF WS” may cause deterioration in shift quality, locking up of your transmission accompanied by vibration, and ultimately damage the transmission of your vehicle.

## Front differential (AWD models)

Oil capacity	0.74 qt. (0.70 L, 0.62 Imp.qt.)
Oil type and viscosity	Hypoid gear oil API GL-5 Above 0°F (-18°C): SAE90 Below 0°F (-18°C): SAE80W or SAE80W-90

## Rear differential

Oil capacity	1.43 qt. (1.35 L, 1.19 Imp.qt.)
Oil type and viscosity	Toyota Genuine Differential gear oil LT 75W-85 GL-5 or equivalent

Your Lexus vehicle is filled with “Toyota Genuine Differential Oil” at the factory. Use Lexus approved “Toyota Genuine Differential Gear Oil” or an equivalent of matching quality to satisfy the above specification. Please contact your Lexus dealer for further details.

## Brakes

Pedal clearance*	2WD	4.5 in. (115 mm) Min.
	AWD	5.0 in. (126 mm) Min.
Pedal free play	0.04 – 0.08 in. (1.0 – 2.0 mm)	
Brake pad wear limit	0.04 in. (1.0 mm)	
Parking brake lining wear limit	0.04 in. (1.0 mm)	
Fluid type	SAE J1703 or FMVSS No. 116 DOT 3	

\*: Minimum pedal clearance when depressed with a force of 112.4 lbf (500 N, 51.0 kgf) while the engine is operating.

## Steering

Free play	Less than 1.2 in. (30 mm)
-----------	---------------------------

## Tires and wheels

### ► Type A

Tire size	225/50R17 94W
Tire inflation pressure (Recommended cold tire inflation pressure)	Front tire 33 psi (230 kPa, 2.3 kgf/cm <sup>2</sup> or bar) Rear tire 33 psi (230 kPa, 2.3 kgf/cm <sup>2</sup> or bar)
Wheel size	17 × 7 1/2J
Wheel nut torque	76 ft•lbf (103 N•m, 10.5 kgf•m)

### ► Type B

Tire size	235/45R18 94Y, P235/45R18 94V
Tire inflation pressure (Recommended cold tire inflation pressure)	Front tire 33 psi (230 kPa, 2.3 kgf/cm <sup>2</sup> or bar) Rear tire 33 psi (230 kPa, 2.3 kgf/cm <sup>2</sup> or bar)
Wheel size	18 × 8J
Wheel nut torque	76 ft•lbf (103 N•m, 10.5 kgf•m)

FarmaSOS.com

## ► Type C

Tire size	235/40R19 96Y XL, 265/35R19 94Y, 235/40R19 96V XL
Tire inflation pressure (Recommended cold tire inflation pressure)	Front tire 35 psi (240 kPa, 2.4 kgf/cm <sup>2</sup> or bar) Rear tire 36 psi (250 kPa, 2.5 kgf/cm <sup>2</sup> or bar)
Wheel size	19 × 8J (235/40R19), 19 × 9J (265/35R19)
Wheel nut torque	76 ft•lbf (103 N•m, 10.5 kgf•m)

## ► Compact spare tire

Tire size	T155/70D17 110M, T145/70D18 107M
Tire inflation pressure (Recommended cold tire inflation pressure)	60 psi (420 kPa, 4.2 kgf/cm <sup>2</sup> or bar)
Wheel size	17 × 4T (T155/70D17), 18 × 4T (T145/70D18)
Wheel nut torque	76 ft•lbf (103 N•m, 10.5 kgf•m)

تلفن شبانه روزی: ۰۲۱-۸۸۶۲۰۸۵

FarmaSOS.com

## Light bulbs

	Light Bulbs	Bulb No.	W	Type
Exterior	Headlights	—	35	A
	Fog lights*	—	55	B
	Front turn signal lights	7444NA	28/8	C
	Rear turn signal lights	W21W	21	D
	Back-up lights	W16W	16	D
	Outer foot lights	W5W	5	D
Interior	Door courtesy lights	—	5	D
	Vanity lights	—	8	D
	Trunk light	—	3.8	C

A: D4S discharge bulbs

B: H11 halogen bulbs

C: Wedge base bulbs (amber)

D: Wedge base bulbs (clear)

\*: If equipped

امداد خودرو فارما  
تلفن شبانه روزی: ۰۲۱-۸۸۶۲۰۸۵  
FarmaSOS.com

## Fuel information

You must only use unleaded gasoline in your vehicle.

Select premium unleaded gasoline with an octane rating of 91 (Research Octane Number 96) or higher required for optimum engine performance. If 91 octane cannot be obtained, you may use unleaded gasoline with an octane rating as low as 87 (Research Octane Number 91). Use of unleaded gasoline with an octane rating lower than 91 may result in engine knocking and significantly reduced performance. Persistent knocking can lead to engine damage and should be corrected by refueling with higher octane unleaded gasoline.

At minimum, the gasoline you use should meet the specifications of ASTM D4814 in the U.S.A. and CGSB3.5-M93 in Canada.

---

### ■ Fuel tank opening for unleaded gasoline

To help prevent incorrect fueling, your vehicle has a fuel tank opening that only accommodates the special nozzle on unleaded fuel pumps.

### ■ Gasoline quality

In very few cases, driveability problems may be caused by the brand of gasoline you are using. If driveability problems persist, try changing the brand of gasoline. If this does not correct the problem, consult your Lexus dealer.

### ■ Gasoline quality standards

- Automotive manufacturers in the U.S.A., Europe and Japan have developed a specification for fuel quality called the World-Wide Fuel Charter (WWFC), which is expected to be applied worldwide.
- The WWFC consists of four categories that are based on required emission levels. In the U.S., category 4 has been adopted.
- The WWFC improves air quality by lowering emissions in vehicle fleets, and improves customer satisfaction through better performance.



### ■ Recommendation of the use of gasoline containing detergent additives

- Lexus recommends the use of gasoline that contains detergent additives to avoid the build-up of engine deposits.
- All gasoline sold in the U.S.A. contains detergent additives to clean and/or keep clean intake systems.

### ■ Recommendation of the use of cleaner burning gasoline

Cleaner burning gasoline, including reformulated gasoline that contains oxygenates such as ethanol or MTBE (Methyl Tertiary Butyl Ether) is available in many areas.

Lexus recommends the use of cleaner burning gasoline and appropriately blended reformulated gasoline. These types of gasoline provide excellent vehicle performance, reduce vehicle emissions and improve air quality.

### ■ Non-recommendation of the use of blended gasoline

- Use only gasoline containing a maximum of 10% ethanol.  
DO NOT use any flex-fuel or gasoline that could contain more than 10% ethanol, including from any pump labeled E15, E30, E50, E85 (which are only some examples of fuel containing more than 10% ethanol).

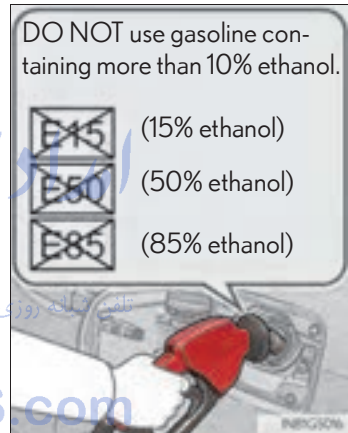

تلف نموده روزی: ۰۲۱-۸۸۶۲۰۸۵

FarmaSOS.com

- If you use gasohol in your vehicle, be sure that it has an octane rating no lower than 87.
- Lexus does not recommend the use of gasoline containing methanol.

### ■ Non-recommendation of the use of gasoline containing MMT

Some gasoline contains an octane enhancing additive called MMT (Methylcyclopentadienyl Manganese Tricarbonyl).

Lexus does not recommend the use of gasoline that contains MMT. If fuel containing MMT is used, your emission control system may be adversely affected.

The malfunction indicator lamp on the instrument cluster may come on. If this happens, contact your Lexus dealer for service.

### ■ If your engine knocks

- Consult your Lexus dealer.
- You may occasionally notice light knocking for a short time while accelerating or driving uphill. This is normal and there is no need for concern.

 NOTICE**■ Notice on fuel quality**

- Do not use improper fuels. If improper fuels are used, the engine will be damaged.
- Do not use leaded gasoline.  
Leaded gasoline can cause damage to your vehicle's three-way catalytic converters causing the emission control system to malfunction.
- Do not use gasohol other than the type previously stated.  
Other gasohol may cause fuel system damage or vehicle performance problems.
- Using unleaded gasoline with an octane number or rating lower than the level previously stated will cause persistent heavy knocking.  
At worst, this will lead to engine damage.

**■ Fuel-related poor driveability**

If poor driveability is encountered after using a different type of fuel (poor hot starting, vaporization, engine knocking, etc.), discontinue the use of that type of fuel.

**■ When refueling with gasohol**

Take care not to spill gasohol. It can damage your vehicle's paint.

تلفن شبانه روزی: ۰۲۱-۸۸۶۲۰۸۵

FarmaSOS.com

## Tire information

### Typical tire symbols

#### ► Full-size tire



#### ► Compact spare tire



- ① Tire size (→P. 768)
- ② DOT and Tire Identification Number (TIN) (→P. 767)
- ③ Location of treadwear indicators (→P. 629)
- ④ Tire ply composition and materials

Plies are layers of rubber-coated parallel cords. Cords are the strands which form the plies in a tire.

- ⑤ Radial tires or bias-ply tires

A radial tire has "RADIAL" on the sidewall. A tire not marked "RADIAL" is a bias-ply tire.

- ⑥ TUBELESS or TUBE TYPE

A tubeless tire does not have a tube and air is directly put into the tire. A tube type tire has a tube inside the tire and the tube maintains the air pressure.

- ⑦ Load limit at maximum cold tire inflation pressure (→P. 772)
- ⑧ Maximum cold tire inflation pressure (→P. 772)

This means the pressure to which a tire may be inflated.

- ⑨ Uniform tire quality grading

For details, see "Uniform Tire Quality Grading" that follows.

- ⑩ Summer tires or all season tires (→P. 634)

An all season tire has "M+S" on the sidewall. A tire not marked "M+S" is a summer tire.

- ⑪ "TEMPORARY USE ONLY"

A compact spare tire is identified by the phrase "TEMPORARY USE ONLY" molded on its sidewall. This tire is designed for temporary emergency use only.

## Typical DOT and Tire Identification Number (TIN)

- ① DOT symbol\*
- ② Tire Identification Number (TIN)
- ③ Tire manufacturer's identification mark
- ④ Tire size code
- ⑤ Manufacturer's optional tire type code (3 or 4 letters)
- ⑥ Manufacturing week
- ⑦ Manufacturing year

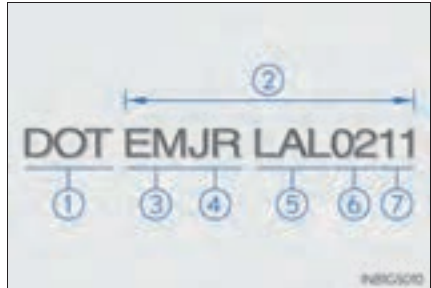

\*: The DOT symbol certifies that the tire conforms to applicable Federal Motor Vehicle Safety Standards.

امداد خودرو فارما

تلفن شبانه روزی: ۰۲۱-۸۸۶۲۰۸۵

FarmaSOS.com

## Tire size

### ■ Typical tire size information

The illustration indicates typical tire size.

- ① Tire use (P = Passenger car, T = Temporary use)
- ② Section width (millimeters)
- ③ Aspect ratio (tire height to section width)
- ④ Tire construction code (R = Radial, D = Diagonal)
- ⑤ Wheel diameter (inches)
- ⑥ Load index (2 digits or 3 digits)
- ⑦ Speed symbol (alphabet with one letter)



### ■ Tire dimensions

- ① Section width
- ② Tire height
- ③ Wheel diameter



امداد خودرو فارما

تلفن شبانه روزی: ۰۸۵-۶۲۰۸۸۶۲-۱

FarmaSOS.com

## Tire section names

- ① Bead
- ② Sidewall
- ③ Shoulder
- ④ Tread
- ⑤ Belt
- ⑥ Inner liner
- ⑦ Reinforcing rubber
- ⑧ Carcass
- ⑨ Rim lines
- ⑩ Bead wires
- ⑪ Chafer

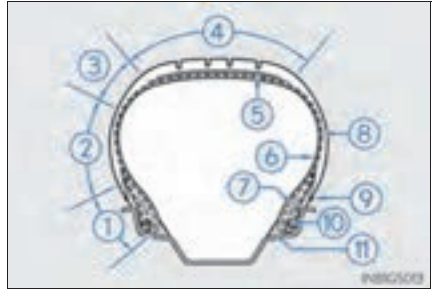

امداد خودرو فارما

تلفن شبانه روزی: ۰۲۱-۸۸۸۶۲۰۸۵

FarmaSOS.com

## Uniform Tire Quality Grading

This information has been prepared in accordance with regulations issued by the National Highway Traffic Safety Administration of the U.S. Department of Transportation.

It provides the purchasers and/or prospective purchasers of Lexus vehicles with information on uniform tire quality grading.

Your Lexus dealer will help answer any questions you may have as you read this information.

### ■ DOT quality grades

All passenger vehicle tires must conform to Federal Safety Requirements in addition to these grades. Quality grades can be found where applicable on the tire sidewall between tread shoulder and maximum section width.

For example: Treadwear 200 Traction AA Temperature A

### ■ Treadwear

The treadwear grade is a comparative rating based on the wear rate of the tire when tested under controlled conditions on a specified government test course.

For example, a tire graded 150 would wear one and a half (1 - 1/2) times as well on the government course as a tire graded 100.

The relative performance of tires depends upon the actual conditions of their use. Performance may differ significantly from the norm due to variations in driving habits, service practices and differences in road characteristics and climate.

### ■ Traction AA, A, B, C

The traction grades, from highest to lowest, are AA, A, B and C, and they represent the tire's ability to stop on wet pavement as measured under controlled conditions on specified government test surfaces of asphalt and concrete.

A tire marked C may have poor traction performance.

Warning: The traction grade assigned to this tire is based on braking (straight ahead) traction tests and does not include cornering (turning) traction.



## ■ Temperature A, B, C

The temperature grades are A (the highest), B, and C, representing the tire's resistance to the generation of heat and its ability to dissipate heat when tested under controlled conditions on a specified indoor laboratory test wheel.

Sustained high temperature can cause the material of the tire to degenerate and reduce tire life, and excessive temperature can lead to sudden tire failure.

Grade C corresponds to a level of performance which all passenger car tires must meet under the Federal Motor Vehicle Safety Standard No. 109.

Grades B and A represent higher levels of performance on the laboratory test wheel than the minimum required by law.

Warning: The temperature grades of a tire assume that it is properly inflated and not overloaded.

Excessive speed, underinflation, or excessive loading, either separately or in combination, can cause heat buildup and possible tire failure.

تلفن شبانه روزی: ۰۲۱-۸۸۶۲۰۸۵

FarmaSOS.com

## Glossary of tire terminology

Tire related term	Meaning
Cold tire inflation pressure	Tire pressure when the vehicle has been parked for three hours or more, or has not been driven more than 1 mile or 1.5 km under that condition
Maximum inflation pressure	The maximum cold inflated pressure to which a tire may be inflated, shown on the sidewall of the tire
Recommended inflation pressure	Cold tire inflation pressure recommended by a manufacturer
Accessory weight	The combined weight (in excess of those standard items which may be replaced) of automatic transmission, power steering, power brakes, power windows, power seats, radio and heater, to the extent that these items are available as factory-installed equipment (whether installed or not)
Curb weight	The weight of a motor vehicle with standard equipment, including the maximum capacity of fuel, oil and coolant, and if so equipped, air conditioning and additional weight optional engine
Maximum loaded vehicle weight	The sum of: (a) Curb weight (b) Accessory weight (c) Vehicle capacity weight (d) Production options weight
Normal occupant weight	150 lb. (68 kg) times the number of occupants specified in the second column of Table 1* that follows
Occupant distribution	Distribution of occupants in a vehicle as specified in the third column of Table 1* below
Production options weight	The combined weight of installed regular production options weighing over 5 lb. (2.3 kg) in excess of the standard items which they replace, not previously considered in curb weight or accessory weight, including heavy duty brakes, ride levelers, roof rack, heavy duty battery, and special trim
Rim	A metal support for a tire or a tire and tube assembly upon which the tire beads are seated

Tire related term	Meaning
Rim diameter (Wheel diameter)	Nominal diameter of the bead seat
Rim size designation	Rim diameter and width
Rim type designation	The industry manufacturer's designation for a rim by style or code
Rim width	Nominal distance between rim flanges
Vehicle capacity weight (Total load capacity)	The rated cargo and luggage load plus 150 lb. (68 kg) times the vehicle's designated seating capacity
Vehicle maximum load on the tire	The load on an individual tire that is determined by distributing to each axle its share of the maximum loaded vehicle weight, and dividing by two
Vehicle normal load on the tire	The load on an individual tire that is determined by distributing to each axle its share of curb weight, accessory weight, and normal occupant weight (distributed in accordance with Table 1* below), and dividing by two
Weather side	The surface area of the rim not covered by the inflated tire
Bead	The part of the tire that is made of steel wires, wrapped or reinforced by ply cords and that is shaped to fit the rim
Bead separation	A breakdown of the bond between components in the bead
Bias ply tire	A pneumatic tire in which the ply cords that extend to the beads are laid at alternate angles substantially less than 90 degrees to the centerline of the tread
Carcass	The tire structure, except tread and sidewall rubber which, when inflated, bears the load
Chunking	The breaking away of pieces of the tread or sidewall
Cord	The strands forming the plies in the tire
Cord separation	The parting of cords from adjacent rubber compounds
Cracking	Any parting within the tread, sidewall, or innerliner of the tire extending to cord material

Tire related term	Meaning
CT	A pneumatic tire with an inverted flange tire and rim system in which the rim is designed with rim flanges pointed radially inward and the tire is designed to fit on the underside of the rim in a manner that encloses the rim flanges inside the air cavity of the tire
Extra load tire	A tire designed to operate at higher loads and at higher inflation pressures than the corresponding standard tire
Groove	The space between two adjacent tread ribs
Innerliner	The layer(s) forming the inside surface of a tubeless tire that contains the inflating medium within the tire
Innerliner separation	The parting of the innerliner from cord material in the carcass
Intended outboard sidewall	<p>(a) The sidewall that contains a whitewall, bears white lettering, or bears manufacturer, brand, and/or model name molding that is higher or deeper than the same molding on the other sidewall of the tire, or</p> <p>(b) The outward facing sidewall of an asymmetrical tire that has a particular side that must always face outward when mounted on a vehicle</p>
Light truck (LT) tire	A tire designated by its manufacturer as primarily intended for use on lightweight trucks or multipurpose passenger vehicles
Load rating	The maximum load that a tire is rated to carry for a given inflation pressure
Maximum load rating	The load rating for a tire at the maximum permissible inflation pressure for that tire
Maximum permissible inflation pressure	The maximum cold inflation pressure to which a tire may be inflated
Measuring rim	The rim on which a tire is fitted for physical dimension requirements
Open splice	Any parting at any junction of tread, sidewall, or innerliner that extends to cord material
Outer diameter	The overall diameter of an inflated new tire

Tire related term	Meaning
Overall width	The linear distance between the exteriors of the sidewalls of an inflated tire, including elevations due to labeling, decorations, or protective bands or ribs
Passenger car tire	A tire intended for use on passenger cars, multipurpose passenger vehicles, and trucks, that have a gross vehicle weight rating (GVWR) of 10,000 lb. or less.
Ply	A layer of rubber-coated parallel cords
Ply separation	A parting of rubber compound between adjacent plies
Pneumatic tire	A mechanical device made of rubber, chemicals, fabric and steel or other materials, that, when mounted on an automotive wheel, provides the traction and contains the gas or fluid that sustains the load
Radial ply tire	A pneumatic tire in which the ply cords that extend to the beads are laid at substantially 90 degrees to the centerline of the tread
Reinforced tire	A tire designed to operate at higher loads and at higher inflation pressures than the corresponding standard tire
Section width	The linear distance between the exteriors of the sidewalls of an inflated tire, excluding elevations due to labeling, decoration, or protective bands
Sidewall	That portion of a tire between the tread and bead
Sidewall separation	The parting of the rubber compound from the cord material in the sidewall
Snow tire	A tire that attains a traction index equal to or greater than 110, compared to the ASTM E-1136 Standard Reference Test Tire, when using the snow traction test as described in ASTM F-1805-00, Standard Test Method for Single Wheel Driving Traction in a Straight Line on Snow-and Ice-Covered Surfaces, and which is marked with an Alpine Symbol (  ) on at least one sidewall
Test rim	The rim on which a tire is fitted for testing, and may be any rim listed as appropriate for use with that tire

Tire related term	Meaning
Tread	That portion of a tire that comes into contact with the road
Tread rib	A tread section running circumferentially around a tire
Tread separation	Pulling away of the tread from the tire carcass
Treadwear indicators (TWI)	The projections within the principal grooves designed to give a visual indication of the degrees of wear of the tread
Wheel-holding fixture	The fixture used to hold the wheel and tire assembly securely during testing

\*: Table 1— Occupant loading and distribution for vehicle normal load for various designated seating capacities

Designated seating capacity, Number of occupants	Vehicle normal load, Number of occupants	Occupant distribution in a normally loaded vehicle
2 through 4	2	2 in front
5 through 10	3	2 in front, 1 in second seat
11 through 15	5	2 in front, 1 in second seat, 1 in third seat, 1 in fourth seat
16 through 20	7	2 in front, 2 in second seat, 2 in third seat, 1 in fourth seat

## Customizable features

Your vehicle includes a variety of electronic features that can be personalized to your preferences. These preferences can be changed by using the “DISP” button, by using the Remote Touch, or at your Lexus dealer.

### Customizing vehicle features

#### ■ Changing by using the Remote Touch

- ▶ Vehicles without a navigation system

**1** “Vehicle Settings” screen displayed on the Remote Touch screen.  
(→P. 317)

**2** Select “Vehicle Customization” on the “Vehicle Settings” screen.

“Vehicle Customization” screen will appear.

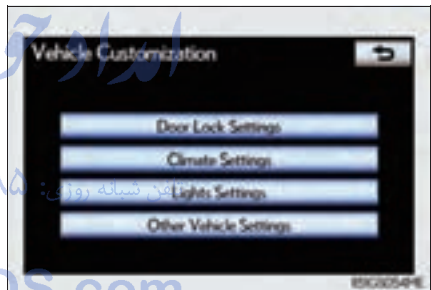

**3** Choose a category displayed on the screen to display the settings.

**4** Select the setting to be changed. Change each setting.

For items that can be enabled/disabled, and for items with an operating time that can be changed, select “On” or “Off”, or select the desired operating time.

For items with sensor sensitivity that can be changed, select “+” or “-” to choose the desired level, then select “OK”.

**5** A message indicating that the settings are being saved will appear. Do not perform any other operations while this message is displayed.

▶ Vehicles with a navigation system  
→Refer to “Navigation System Owner’s Manual”.

■ Changing by using the “DISP” button

→P. 86

امداد خودرو فارما

تلفن شبانه روزی: ۰۲۱-۸۸۸۶۲۰۸۵

FarmaSOS.com



## Customizable features

Some function settings are changed simultaneously with other functions being customized. Contact your Lexus dealer for further details.

- ① Settings that can be changed using the Remote Touch
- ② Settings that can be changed using the “DISP” button
- ③ Settings that can be changed by your Lexus dealer

Definition of symbols: ○ = Available, – = Not available

Item	Function	Default setting	Customized setting	①	②	③
Multi-information display (→P. 82)	“Language”*1	“American English”	“Français” (French)	–	○	–
			“Español” (Spanish)	–	○	–
	“Units”*1	“miles (MPG)”	“km (km/L)”	–	○	–
			“km (L/100km)”	–	○	–
	“ECO lamp”	“ON (Self-lighting)”	“OFF”	–	○	–
			“ON (Always)”	–	○	–
	“Drive monitor”	“Outside”	“Fuel consumption”	–	○	–
			“Cruising range”	–	○	–
	“Lamp brightness”	“Standard”	“Bright”	–	○	–
	“SPORT lamp”	“ON”	“OFF”	–	○	–
“Default settings”	“OFF”	“ON”	–	○	–	

Item	Function	Default setting	Customized setting	①	②	③
Door lock (→P. 117, 740)	"Unlock on Second Key Turn" (Allows all doors to be unlocked by turning the mechanical key once in the driver's door)	On (Driver's door unlocked in one step, all doors unlocked in two steps)	Off (All doors unlocked in one step)	<input type="radio"/>	-	<input type="radio"/>
	"Auto Lock by Speed" (All doors are automatically locked when vehicle speed is approximately 12 mph [20 km/h] or higher)	Off	On	<input type="radio"/>	-	<input type="radio"/>
	"Auto Lock by Shift from P" (All doors are automatically locked when shifting the shift lever to position other than P)	On	Off	<input type="radio"/>	-	<input type="radio"/>
	"Auto Unlock by Shift to P" (All doors are automatically unlocked when shifting the shift lever to P)	On	Off	<input type="radio"/>	-	<input type="radio"/>
	"Auto Unlock by Driver Door" (All doors are automatically unlocked when driver's door is opened)	Off	On	<input type="radio"/>	-	<input type="radio"/>

Item	Function	Default setting	Customized setting	①	②	③
Smart access system with push-button start (→P.101) and wireless remote control (→P.114)	"Lock/Unlock Feedback-Tone" (Adjust the volume of buzzer sounds)	5	Off	○	-	○
			1 to 7			
	"Lock/Unlock Feedback-Lights" (Enable/disable the operation of the emergency flashers when the vehicle is locked or unlocked)	On	Off	○	-	○
	"Auto Relock Timer" (Adjust the time elapsed before the automatic door lock function is activated if a door is not opened after being unlocked)	60 seconds	Off	○	-	○
			30 seconds			
		120 seconds				
Open door reminder buzzer (When locking the vehicle)	On	Off	-	-	○	
Smart access system with push-button start (→P.101)	"Access System with Elec. Key" (Smart access system with push-button start can be disabled)	On	Off	○	-	○
	"Select Doors to Unlock" (The doors that are unlocked using the smart access system with push-button start can be selected)	Driver's door	All the doors	○	-	○
	Number of consecutive door lock operations	2 times	As many as desired	-	-	○

Item	Function	Default setting	Customized setting	①	②	③
Wireless remote control (→P.114)	Wireless remote control	On	Off	-	-	○
	"Remote 2-Press Unlock" (Allows all doors to be unlocked by pressing  on the electronic key once)	On (Driver's door unlocked in one step, all doors unlocked in two steps)	Off (All doors unlocked in one step)	○	-	○
	Trunk unlocking operation	Press and hold (short)	One short press	-	-	○
			Push twice			
			Press and hold (long)			
Off						
Alarm (panic mode)	On	Off	-	-	○	
Front seats (→P.128)	"Driver's Seat Easy Exit" (Driver's seat movement when exiting the vehicle)	Standard	Off	○	-	○
			Partial			
	Selecting the door linking driving position memory with door unlock operation	Driver's door	All doors	-	-	○

Item	Function	Default setting	Customized setting	①	②	③
Power windows (→P.145) and moon roof (→P.148)	Mechanical key linked operation	Off	On	-	-	○
	Wireless remote control linked operation	Off	On (Open only)	-	-	○
	Buzzer sounds if operated using wireless remote control	On	Off	-	-	○
Turn signal lever (→P.184)	The number of times the turn signal lights flash automatically when the turn signal lever is moved to the first position during a lane change (After flashing the turn signal lights when turning left or right while this function is off and the turn signal lever is moved to the first position in direction of the flashing light, the turn signal lights can be selected to be flashing or off.)	3	5	-	-	○
			7			
			Off (the turn signal lights keep flashing if the turn signal lever is moved to the first position in direction of flashing light)			
			Off (the turn signal lights will be off if the turn signal lever is moved to the first position in direction of flashing light)			

Item	Function	Default setting	Customized setting	①	②	③
Automatic light control system (→P.190)	"Headlamps-On Sensitivity" (Adjust the sensitivity of the ambient light sensor)	Standard	-2 to 2	○	-	○
	"Headlamps Auto-Off Timer" (Adjust the time elapsed before the headlights automatically turn off)	30 seconds	Off	○	-	○
			60 seconds			
			90 seconds			
Welcome light illumination control	On	Off	-	-	○	
Lights (→P.190)	"Daytime Running Lights" (Daytime running lights can be disabled)*3	On	Off	○	-	○
Intuitive parking assist*2 (→P.238)	"Detection (Front)" (Detection distance of the front center sensor)	Far	Near	○	-	○
	"Detection (Rear)" (Detection distance of the rear center sensor)	Far	Near	○	-	○
	"Alert Volume" (Alert volume can be adjusted)	3	1 to 5	○	-	○
	"Display" (when intuitive parking assist is operating)	All sensors displayed	Display off	○	-	○
Automatic air conditioning system (→P.345)	"Efficient Ventilation Mode" (Switching between outside air and recirculated air mode linked to "AUTO" switch operation)	On	Off	○	-	○
	"Auto A/C Mode" (A/C Auto switch operation)	On	Off	○	-	○
	"Smog Sensor Sensitivity" (Exhaust gas sensor sensitivity)	Standard	-3 to 3	○	-	○

Item	Function	Default setting	Customized setting	①	②	③
Illumination (→P. 548)	Interior lights illumination control	On	Off	-	-	○
	“Interior Lights Off Timer” (Time elapsed before the interior lights turn off)	15 seconds	7.5 seconds	○	-	○
			30 seconds			
	Operation after the engine switch is turned off	On	Off	-	-	○
	Operation when the doors are unlocked	On	Off	-	-	○
	Operation when you approach the vehicle with the electronic key on your person	On	Off	-	-	○
	Footwell lighting	On	Off	-	-	○
	Outer foot lights	On	Off	-	-	○
“Exterior Lights Off Timer” (Time elapsed before the outer foot lights turn off)	15 seconds	Off	○	-	○	
		7.5 seconds				
		30 seconds				

Item	Function	Default setting	Customized setting	①	②	③
Illumination (→P. 548)	Enable/disable operation of the outer foot lights when you approach the vehicle with the electronic key on your person	On	Off	-	-	○
	Enable/disable operation of the outer foot lights when the doors are unlocked with the power door lock switch	On	Off	-	-	○
Rear sunshade*2 (→P. 572)	Reverse operation	On	Off	-	-	○
	Time elapsed before the reverse operation feature activates	0.7 seconds	0 second	-	-	○
			0.9 seconds			
		1.2 seconds				

\*1: The default setting varies according to countries.

\*2: If equipped

\*3: U.S.A. only

تلفن شبانه روزی: ۰۲۱-۸۸۶۲۰۸۵

FarmaSOS.com



### ■ Vehicle customization

- When the “Auto Lock by Speed” and “Auto Lock by Shift from P” are both on, the door lock operates as follows.
  - When shifting the shift lever to any position other than P, all the doors will be locked.
  - If the vehicle is started with all the doors locked, the “Auto Lock by Speed” would not operate.
  - If the vehicle is started with any door unlocked, the “Auto Lock by Speed” will operate.
- When the smart access system with push-button start is off, the “Select Doors to Unlock” cannot be customized.
- When the doors remain closed after unlocking the doors and the “Auto Relock Timer” activates, the signals will be generated in accordance with the “Lock/Unlock Feedback-Tone” and the “Lock/Unlock Feedback-Lights” settings.

### ■ When customizing using the Remote Touch

Stop the vehicle in a safe place, apply the parking brake, and shift the shift lever to P. Also, to prevent battery discharge, leave the engine running while customizing the features.

#### CAUTION

##### ■ During customization ۲۱-۸۸۶۲۰۸۵ تلفن شبانه روزی:

As the engine needs to be running during customization, ensure that the vehicle is parked in a place with adequate ventilation. In a closed area such as a garage, exhaust gases including harmful carbon monoxide (CO) may collect and enter the vehicle. This may lead to death or a serious health hazard.

#### NOTICE

##### ■ During customization

To prevent battery discharge, ensure that the engine is running while customizing features.

## Items to initialize

The following items must be initialized for normal system operation after such cases as the battery being reconnected, or maintenance being performed on the vehicle:

Item	When to initialize	Reference
Maintenance data	<ul style="list-style-type: none"> <li>After the maintenance is performed</li> </ul>	P. 602
Tire pressure warning system	<ul style="list-style-type: none"> <li>When rotating the tires</li> <li>When changing the tire inflation pressure by changing traveling speed or load weight, etc.</li> </ul>	P. 632

امداد خودرو فارما

تلفن شبانه روزی: ۰۲۱-۸۸۶۲۰۸۵

FarmaSOS.com

Reporting safety defects for U.S. owners.....	790
Seat belt instructions for Canadian owners (in French).....	791
SRS airbag instructions for Canadian owners (in French).....	793

امداد خودرو فارما

تلفن شبانه روزی: ۰۲۱-۸۸۸۶۲۰۸۵

[FarmaSOS.com](http://FarmaSOS.com)

## Reporting safety defects for U.S. owners

If you believe that your vehicle has a defect which could cause a crash or could cause injury or death, you should immediately inform the National Highway Traffic Safety Administration (NHTSA) in addition to notifying the Lexus Division of Toyota Motor Sales, U.S.A., Inc. (Toll-free: 1-800-25-LEXUS).

If NHTSA receives similar complaints, it may open an investigation, and if it finds that a safety defect exists in a group of vehicles, it may order a recall and remedy campaign. However, NHTSA cannot become involved in individual problems between you, your dealer, or Lexus Division of Toyota Motor Sales, U.S.A., Inc.

To contact NHTSA, you may call the Vehicle Safety Hotline toll-free at 1-888-327-4236 (TTY: 1-800-424-9153); go to <http://www.safercar.gov>; or write to: Administrator, NHTSA, 1200 New Jersey Ave, S.E., Washington, DC 20590. You can also obtain other information about motor vehicle safety from <http://www.safercar.gov>.

تلفن شبانه روزی: +۸۵ ۲۰۶۶۲-۲۱

FarmaSOS.com

## Seat belt instructions for Canadian owners (in French)

The following is a French explanation of seat belt instructions extracted from the seat belt section in this manual.

See the seat belt section for more detailed seat belt instructions in English.

### Utilisation adéquate des ceintures de sécurité

- Tirez sur la ceinture épaulière jusqu'à ce qu'elle recouvre entièrement l'épaule; elle ne doit cependant pas toucher le cou ni glisser de l'épaule.
- Placez la ceinture abdominale le plus bas possible sur les hanches.
- Réglez la position du dossier. Tenez-vous assis bien au fond du siège, le dos droit.
- Ne vrillez pas la ceinture de sécurité.



INTIGS050a

### Guide des ceintures de sécurité (sièges latéraux arrière)

Pour les enfants ou les personnes de taille inférieure à la moyenne, faites glisser le guide de la ceinture de sécurité vers l'avant, de sorte que la ceinture épaulière ne repose pas près du cou de cette personne.

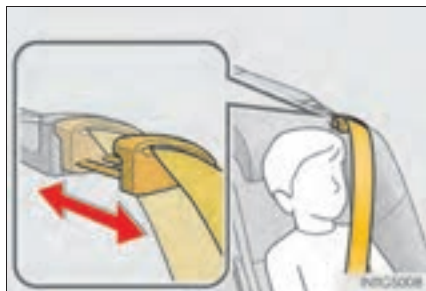

INTIG008

## Entretien et soin

### ■ Ceintures de sécurité

Avec un chiffon ou une éponge, nettoyez à l'aide d'un savon doux et de l'eau tiède. Vérifiez aussi les ceintures régulièrement pour vous assurer qu'elles ne présentent pas d'usure excessive, d'effilochage ou de coupures.

### ATTENTION

#### ■ Dommages et usure de la ceinture de sécurité

Vérifiez périodiquement le système de ceintures de sécurité. Assurez-vous qu'il n'y a pas de coupures, d'effilochures ni de pièces desserrées. N'utilisez pas une ceinture de sécurité endommagée avant qu'elle ne soit remplacée. Les ceintures de sécurité endommagées ne peuvent pas protéger les occupants contre les blessures graves, voire mortelles.

امداد خودرو فارما

تلفن شبانه روزی: ۰۲۱-۸۸۶۲۰۸۵

FarmaSOS.com

## SRS airbag instructions for Canadian owners (in French)

The following is a French explanation of SRS airbag instructions extracted from the SRS airbag section in this manual.

See the SRS airbag section for more detailed SRS airbag instructions in English.

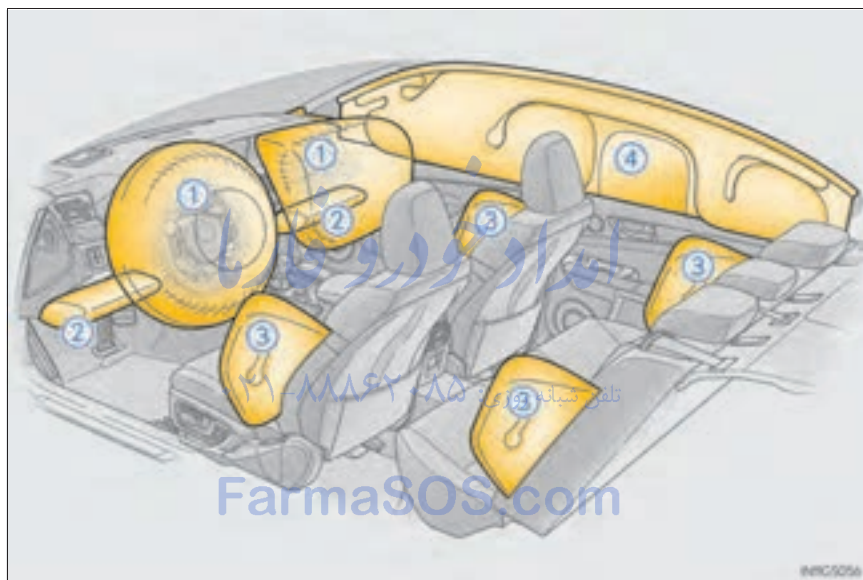

### ◆ Coussins gonflables SRS avant

- ① Coussin gonflable SRS du conducteur/du passager avant  
Peuvent aider à protéger la tête et la poitrine du conducteur et du passager avant contre les impacts avec des composants intérieurs
- ② Coussins gonflables SRS de protection des genoux  
Peuvent aider à protéger le conducteur et le passager avant  
Un coussin gonflable SRS de protection des genoux pour le siège du passager avant est intégré dans la porte de la boîte à gants.

### ◆ Coussins gonflables SRS latéraux et en rideau

---

- ③ Coussins gonflables SRS latéraux avant  
Peuvent aider à protéger le torse des occupants des sièges avant  
Coussins gonflables SRS latéraux arrière  
Peuvent aider à protéger le torse des occupants des sièges latéraux arrière
- ④ Coussins gonflables SRS en rideau  
Peuvent aider à protéger principalement la tête des occupants des sièges latéraux

امداد خودرو فارما

تلفن شبانه روزی: ۰۲۱-۸۸۸۶۲۰۸۵

FarmaSOS.com



## Composants du système de coussins gonflables SRS

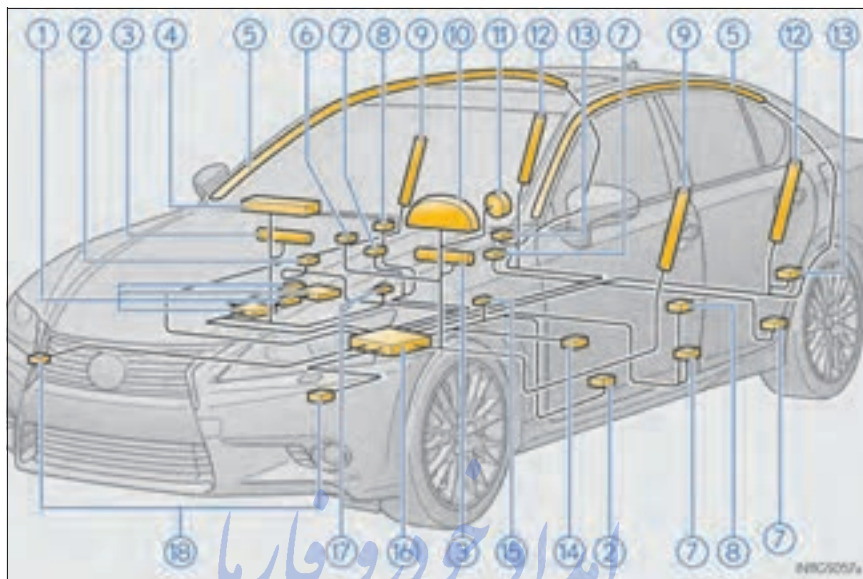

- |  |  |
|--|--|
| ① Système de classification de l'occupant du siège du passager avant (ECU et capteurs) | ⑩ Lampe témoin SRS   |
| ② Capteurs de choc latéral (portières avant)   | ⑪ Coussin gonflable du conducteur                                |
| ③ Coussins gonflables de protection des genoux   | ⑫ Coussins gonflables latéraux arrière                           |
| ④ Coussin gonflable du passager avant  | ⑬ Capteurs de choc latéral (arrière)                             |
| ⑤ Coussins gonflables en rideau  | ⑭ Capteur de position de siège du conducteur                     |
| ⑥ Lampes témoins "AIR BAG ON" et "AIR BAG OFF"   | ⑮ Contacteur de boucle de ceinture de sécurité du conducteur     |
| ⑦ Dispositifs de tension et limiteurs de force des ceintures de sécurité               | ⑯ Module de capteur de coussin gonflable                         |
| ⑧ Capteurs de choc latéral (avant)   | ⑰ Contacteur de boucle de ceinture de sécurité du passager avant |
| ⑨ Coussins gonflables latéraux avant   | ⑱ Capteurs de choc avant   |

Votre véhicule est doté de COUSSINS GONFLABLES ÉVOLUÉS dont la conception s'appuie sur les normes de sécurité des véhicules à moteur américains (FMVSS208). Le module de capteur de coussin gonflable (ECU) contrôle le déploiement des coussins gonflables en fonction des informations obtenues des capteurs et d'autres éléments affichés dans le diagramme des composants du système ci-dessus. Ces informations comprennent des données relatives à la gravité de l'impact et aux passagers. Au moment du déploiement des coussins gonflables, une réaction chimique se produit dans les gonfleurs et les coussins gonflables se remplissent rapidement d'un gaz non toxique pour limiter le mouvement des occupants.

امداد خودرو فارما

تلفن شبانه روزی: ۰۲۱-۸۸۸۶۲۰۸۵

FarmaSOS.com

## ATTENTION

### ■ Précautions relatives aux coussins gonflables SRS

Observez les précautions suivantes en ce qui concerne les coussins gonflables SRS.

Les négliger pourrait occasionner des blessures graves, voire mortelles.

- Le conducteur et tous les passagers du véhicule doivent porter leur ceinture de sécurité de la manière appropriée.

Les coussins gonflables SRS sont des dispositifs supplémentaires qui doivent être utilisés de concert avec les ceintures de sécurité.

- Le coussin gonflable SRS du conducteur se déploie avec une force considérable et peut occasionner des blessures graves, voire mortelles, notamment lorsque le conducteur se trouve très près du coussin gonflable. La National Highway Traffic Safety Administration (NHTSA), aux États-Unis, donne les recommandations suivantes :

La zone à risque d'un coussin gonflable côté conducteur couvre 2 à 3 in. (50 à 75 mm) de la zone de déploiement du coussin gonflable. Pour assurer une marge de sécurité suffisante, restez à 10 in. (250 mm) du coussin gonflable. Cette distance est mesurée depuis le centre du volant jusqu'à votre sternum. Si vous vous tenez à moins de 10 in. (250 mm), vous pouvez changer votre position de conduite de plusieurs manières :

- Reculez votre siège à la position maximale vous permettant d'atteindre encore aisément les pédales.
- Inclinez légèrement le dossier du siège.  
Même si les véhicules sont conçus différemment, la plupart des conducteurs peuvent maintenir une distance de 10 in. (250 mm), même si le siège se trouve complètement vers l'avant, simplement en inclinant un peu le dossier du siège vers l'arrière. Si la visibilité avant est moindre après avoir incliné le dossier du siège, utilisez un coussin ferme et non glissant pour être assis plus haut ou relevez le siège si cette option est disponible sur votre véhicule.
- Si votre volant est réglable en hauteur, inclinez-le vers le bas. Cela vous permet d'orienter le coussin gonflable vers votre buste plutôt que vers la tête et vers le cou.

Le siège doit être réglé de la manière recommandée ci-dessus par la NHTSA, tout en gardant le contrôle des pédales et du volant, et la vue sur les commandes du bloc d'instrumentation.

## ⚠ ATTENTION

### ■ Précautions relatives aux coussins gonflables SRS

- Si la rallonge de ceinture de sécurité a été reliée à la boucle des ceintures de sécurité des sièges avant sans avoir été attachée à la plaque de blocage des ceintures de sécurité, les coussins gonflables SRS avant considéreront que le conducteur et le passager avant portent tout de même leur ceinture même si elles ne sont pas attachées. Les coussins gonflables SRS avant peuvent alors ne pas s'activer correctement lors d'une collision, ce qui représente un risque de blessures graves, voire mortelles. Bouclez toujours votre ceinture de sécurité lorsque vous utilisez la rallonge.



- Le coussin gonflable SRS du passager avant se déploie également avec une force considérable et peut occasionner des blessures graves, voire mortelles, notamment lorsque le passager avant se trouve très près du coussin gonflable. Le siège du passager avant doit se trouver le plus loin possible du coussin gonflable et le dossier doit être réglé de manière à ce que le passager avant soit assis bien droit.   
تلفن شبانه روزی: ۰۲۱-۸۸۶۲۰۸۵
- Le déploiement d'un coussin gonflable risque d'infliger des blessures graves, voire mortelles, aux bébés et aux enfants mal assis ou mal attachés. Un bébé ou un enfant trop petit pour utiliser une ceinture de sécurité doit être correctement retenu à l'aide d'un dispositif de retenue pour enfants. Lexus recommande vivement de placer et d'attacher correctement tous les bébés et tous les enfants sur les sièges arrière du véhicule à l'aide de dispositifs de retenue adaptés. Les sièges arrière sont plus sécuritaires pour les bébés et les enfants que le siège du passager avant. (→P. 56)

## ⚠ ATTENTION

### ■ Précautions relatives aux coussins gonflables SRS

- Ne vous asseyez pas sur le bord du siège et ne vous appuyez pas sur le tableau de bord.

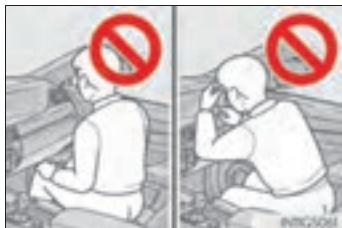

- Ne laissez pas un enfant se tenir face au coussin gonflable SRS du passager avant ni s'asseoir sur les genoux d'un passager avant.



- Ne laissez pas les occupants du siège avant tenir des objets sur leurs genoux.

- Ne vous appuyez pas sur la portière ou sur le longeron du toit, ni sur les montants avant, latéraux ou arrière.



- Ne laissez personne s'agenouiller face à la portière sur le siège du passager ni sortir la tête ou les mains à l'extérieur du véhicule.



## ⚠ ATTENTION

### ■ Précautions relatives aux coussins gonflables SRS

- Ne fixez et n'appuyez rien sur des zones telles que le tableau de bord, le tampon de volant, la partie inférieure du bloc d'instrumentation et la porte de la boîte à gants. Ces objets peuvent se transformer en projectiles lorsque les coussins gonflables SRS du conducteur, du passager avant ou de protection des genoux se déploient.

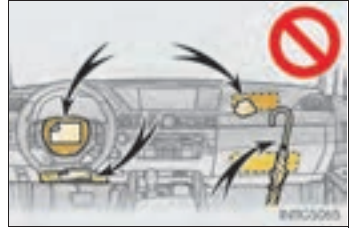

- Ne fixez rien sur les portières, le pare-brise, les glaces latérales, les montants avant ou arrière, le longeron du toit et la poignée d'appui.



- N'accrochez pas de cintres ni d'objets rigides sur les crochets porte-vêtements. Tous ces objets pourraient se transformer en projectiles et vous occasionner des blessures graves, voire mortelles, en cas de déploiement des coussins gonflables SRS en rideau.

- Si un recouvrement de vinyle est placé sur la zone de déploiement du coussin SRS de protection des genoux, veillez à le retirer.

- N'utilisez pas d'accessoires recouvrant les parties du siège où les coussins gonflables SRS latéraux se déploient, car ceux-ci pourraient nuire au déploiement de ces coussins. De tels accessoires peuvent empêcher les coussins gonflables latéraux de se déployer correctement, rendre le système inopérant ou provoquer accidentellement le déploiement des coussins gonflables latéraux, occasionnant des blessures graves, voire mortelles.

- Ne frappez pas et n'appliquez pas une pression importante à l'emplacement des composants de coussins gonflables SRS. Vous risqueriez de provoquer un mauvais fonctionnement des coussins gonflables SRS.

امداد خودرو فارما  
تلفن شبانه روزی: ۰۲۱-۸۸۶۲۰۸۵  
FarmaSOS.com

## ATTENTION

### ■ Précautions relatives aux coussins gonflables SRS

- Ne touchez à aucun composant des coussins gonflables SRS immédiatement après leur déploiement (gonflage), car ils pourraient être chauds.
- Si vous avez de la difficulté à respirer après le déploiement des coussins gonflables SRS, ouvrez une portière ou une glace pour laisser entrer l'air, ou quittez le véhicule si vous pouvez le faire en toute sécurité. Dès que possible, nettoyez tous les résidus afin d'éviter les irritations cutanées.
- Si les emplacements de stockage des coussins gonflables SRS, notamment le tampon de volant, la porte de la boîte à gants et les garnitures des montants avant et arrière, sont endommagés ou fissurés, faites-les remplacer par votre concessionnaire Lexus.

### ■ Modification et mise au rebut des composants du système de coussins gonflables SRS

Ne mettez pas le véhicule au rebut et n'effectuez aucune des modifications suivantes sans d'abord consulter votre concessionnaire Lexus. Les coussins gonflables SRS pourraient fonctionner de manière incorrecte ou se déployer (gonfler) accidentellement, ce qui serait susceptible d'occasionner des blessures graves, voire mortelles.

- Installation, retrait, démontage et réparation des coussins gonflables SRS
- Réparations, modifications, retrait ou remplacement du volant, du bloc d'instrumentation, du tableau de bord, des sièges ou du capitonnage des sièges, des montants avant, latéraux ou arrière et des longerons du toit
- Réparations ou modifications de l'aile ou du pare-chocs avant, ou du côté de l'habitacle
- Installation de lames de déneigement, de treuils, etc. sur la calandre avant (barre safari, barre kangourou, etc.)
- Modifications du système de suspension du véhicule
- Installation d'appareils électroniques tels qu'un émetteur-récepteur radio ou un lecteur de CD
- Modifications à votre véhicule pour une personne aux capacités physiques réduites

# امداد خودرو فارما

تلفن شبانه روزی: ۰۲۱-۸۸۸۶۲۰۸۵

[FarmaSOS.com](http://FarmaSOS.com)



What to do if... (Troubleshooting).....	804
Alphabetical index.....	810

# امداد خودرو فارما

تلفن شبانه روزی: ۰۲۱-۸۸۸۶۲۰۸۵

[FarmaSOS.com](http://FarmaSOS.com)

For vehicles with a navigation system, refer to the “Navigation System Owner’s Manual” for information regarding the navigation system.

## What to do if... (Troubleshooting)

If you have a problem, check the following before contacting your Lexus dealer.

### The doors cannot be locked, unlocked, opened or closed



#### You lose your keys

- If you lose your mechanical keys, new genuine mechanical keys can be made by your Lexus dealer. (→P. 99)
- If you lose your electronic keys, the risk of vehicle theft increases significantly. Contact your Lexus dealer immediately. (→P.100)



#### The doors cannot be locked or unlocked

- Is the electronic key battery weak or depleted? (→P. 646)
- Is the engine switch in IGNITION ON mode?  
When locking the doors, turn the engine switch off. (→P. 172)
- Is the electronic key left inside the vehicle?  
When locking the doors, make sure that you have the electronic key on your person.
- The function may not operate properly due to the condition of the radio wave. (→P. 108)



### The rear door cannot be opened

- Is the child-protector lock set?

The rear door cannot be opened from inside the vehicle when the lock is set. Open the rear door from outside and then unlock the child-protector lock. (→P. 118)

---



### The trunk lid is closed with the electronic key left inside

- The function to prevent the electronic key from being left inside the trunk will operate and you can open the trunk as usual. Take the key out from the trunk. (→P. 102)

تلفن شبانه روزی: ۰۲۱-۸۸۶۲۰۸۵

FarmaSOS.com

## If you think something is wrong



### The engine does not start

- Did you press the engine switch while firmly depressing the brake pedal? (→P. 171)
- Is the shift lever in P? (→P. 174)
- Is the electronic key anywhere detectable inside the vehicle? (→P. 104)
- Is the steering wheel unlocked? (→P. 175)
- Is the electronic key battery weak or depleted?  
In this case, the engine can be started in a temporary way.  
(→P. 741)
- Is the battery discharged? (→P. 743)



### The shift lever cannot be shifted from P even if you depress the brake pedal

- Is the engine switch in IGNITION ON mode?  
If you cannot release the shift lever by depressing the brake pedal with the engine switch in IGNITION ON mode  
(→P. 737)



### The steering wheel cannot be turned after the engine is stopped

- It is locked automatically to prevent theft of the vehicle.  
(→P. 174)



### The windows do not open or close by operating the power window switches

- Is the window lock switch pressed?  
The power window except for the one at the driver's seat cannot be operated if the window lock switch is pressed. (→P. 145)
- 



### The engine switch is turned off automatically

- The auto power off function will be operated if the vehicle is left in ACCESSORY or IGNITION ON mode (the engine is not running) for a period of time. (→P. 174)
- 



### A warning buzzer sounds during driving

- The seat belt reminder light is flashing  
Are the driver and the front passenger wearing the seat belts? (→P. 689)

- The parking brake indicator is on  
Is the parking brake released? (→P. 186)

Depending on the situation, other types of warning buzzer may also sound. (→P. 686, 697)



### An alarm is activated and the horn sounds

- Did anyone inside the vehicle open a door during setting the alarm?

The sensor detects it and the alarm sounds. (→P. 70)

To stop the alarm, turn the engine switch to IGNITION ON mode or start the engine.

---



### A warning buzzer sounds when leaving the vehicle

- Is the electronic key left inside the vehicle or the moon roof opened?

Check the message on the multi-information display.

(→P. 704) اردو خودرو فارما تلفن شبانه روزی: ۰۸۵۰۶۲۰۸۱-۲۱

---



### A warning light turns on or a warning message is displayed

- When a warning light turns on or a warning message is displayed, refer to P. 686, 697.

## When a problem has occurred



### If you have a flat tire

- Stop the vehicle in a safe place and replace the flat tire with the spare tire. (→P. 722)
- 



### The vehicle becomes stuck

- Try the procedure for when the vehicle becomes stuck in mud, dirt, or snow. (→P. 749)

تلفن شبانه روزی: ۰۲۱-۸۸۶۲۰۸۵

FarmaSOS.com

# Alphabetical index

## A

- A/C.....345
- Air conditioning filter.....644
- Front automatic air conditioning system.....345
- Rear air conditioning system.....360
- S-FLOW mode.....355
- ABS (Anti-lock Brake System).....268
- Function.....268
- Warning light.....687
- Warning message.....701
- Adaptive Front-lighting system (AFS).....192
- Adaptive Variable Suspension system (AVS).....269
- AFS (Adaptive Front-lighting System).....192
- Air conditioning filter.....644
- Air conditioning system.....345
- Air conditioning filter.....644
- Front automatic air conditioning system.....345
- Rear air conditioning system.....360
- S-FLOW mode.....355
- Airbags.....36
- Airbag operating conditions.....44
- Airbag precautions for your child.....39
- Airbag warning light.....687
- Correct driving posture.....28
- Curtain shield airbag operating conditions.....44
- Curtain shield airbag precautions.....41
- Front passenger occupant classification system.....47
- General airbag precautions.....39
- Locations of airbags.....36
- Modification and disposal of airbags.....43
- Side airbag operating conditions.....44
- Side airbag precautions.....39
- Side and curtain shield airbags operating conditions.....44
- Side and curtain shield airbags precautions.....39
- SRS airbags.....36
- Alarm.....70
- Alarm.....70
- Warning buzzer.....686, 697
- Anchor brackets.....60
- Antennas (smart access system with push-button start).....103
- Anti-lock Brake System (ABS).....268
- Function.....268
- Warning light.....687
- Warning message.....701
- Approach warning (dynamic radar cruise control).....219
- Armrest.....571



Armrest door .....	575
Ashtrays.....	563
Assist grip .....	577
Audio input.....	476
Audio system.....	367
Audio input.....	476
AUX port/ USB port.....	476, 456, 466
Bluetooth® audio.....	444
CD/DVD player .....	412
CD/DVD player information .....	432
DVD video.....	420
iPod.....	464
MP3/WMA disc .....	414
Optimal use .....	474
Portable music player.....	476
Radio .....	390
Rear seat audio controls .....	477
Steering wheel audio switch .....	482
USB memory .....	454
Automatic headlight leveling system .....	193
Automatic light control system.....	190
Automatic transmission .....	178
If the shift lever cannot be shifted from P .....	737
M mode .....	181
Paddle shift switches .....	180
AUX port.....	476
Auxiliary boxes.....	557
AVS (Adaptive Variable Suspension system).....	269

## B

Back-up lights	
Replacing light bulbs .....	670
Wattage .....	761
Battery .....	624
Battery checking.....	624
If the vehicle battery is discharged .....	743
Preparing and checking before winter.....	298
Warning light.....	687
Bluetooth®	
Audio system .....	444
Hands-free system (for cellular phone) .....	485
Brake	
Fluid .....	623
Parking brake .....	186
Warning light.....	686, 689
Warning message.....	697
Brake assist.....	268
Break-in tips .....	156
Brightness control	
Instrument panel light control .....	80
BSM (Blind Spot Monitor).....	287

## C

- Care.....594, 598
- Aluminum wheels .....595
  - Exterior.....594
  - Interior .....598
  - Seat belts .....599
- Cargo capacity.....168
- Cargo hooks .....558
- CD player .....412
- Chairs .....300
- Child restraint system.....53
- Booster seats, definition .....53
  - Booster seats, installation.....63
  - Convertible seats, definition.....53
  - Convertible seats, installation.....60
  - Front passenger occupant
    - classification system.....47
  - Infant seats, definition .....53
  - Infant seats, installation .....60
  - Installing CRS
    - with LATCH anchors .....58
  - Installing CRS with seat belts.....60
  - Installing CRS
    - with top tether strap.....64
- Child safety .....52
- Airbag precautions.....39
  - Battery precautions.....626, 746
  - Child restraint system.....53
  - How your child should wear
    - the seat belt .....31, 32
  - Installing child restraints .....57
  - Moon roof precautions .....151
  - Power window lock switch.....145
  - Power window precautions.....147
  - Rear door child-protectors .....118
  - Removed electronic
    - key battery precautions .....647
  - Seat belt comfort guide.....31
  - Seat belt extender
    - precautions .....35
  - Seat belt precautions .....56
  - Seat heater precautions.....570
  - Trunk precautions .....124
- Child-protectors .....118
- Cleaning.....594, 598
- Aluminum wheels.....595
  - Exterior .....594
  - Interior .....598
  - Seat belts.....599
- Clock.....562
- Coat hooks .....576
- Condenser .....622
- Console box.....554
- Console box light.....554
- Cooling system
  - Engine overheating .....747
- Cruise control
  - Cruise control .....209
  - Dynamic radar cruise control .....213

Cup holders.....	555
Curtain shield airbags .....	37
Customizable features.....	777

## D

Daytime running light system.....	193
Defogger	
Front windshield.....	352
Outside rear view mirrors.....	365
Rear window .....	365
Differential	
Front differential.....	758
Rear differential.....	758
Dimension .....	752
Dinghy towing.....	170
Display	
Dynamic radar cruise control.....	213
LKA (Lane-Keeping Assist).....	232
Multi-information display.....	82
Remote Touch screen.....	308
Trip information.....	83
Warning message.....	697
Do-it-yourself maintenance.....	609
Door courtesy lights	
Location.....	548
Wattage.....	761
Doors.....	117
Automatic door locking and unlocking system.....	119
Door glasses .....	145
Door lock.....	117
Open door warning buzzer.....	105
Open door warning light.....	689
Outside rear view mirrors.....	142
Rear door child-protector.....	118

Driver's seat position memory.....	130
Driving .....	154
Break-in tips.....	156
Correct driving posture.....	28
Driving mode select switch.....	263
Procedures.....	154
Winter drive tips .....	298
DRS (Dynamic Rear Steering).....	269
Function.....	269
Warning message.....	702
DVD player .....	412, 420
Dynamic radar cruise control.....	213
Function.....	213
Warning message.....	700, 707
Dynamic Rear Steering (DRS).....	269
Function.....	269
Warning message.....	702

## E

Eco drive mode.....	263
Eco Driving Indicator .....	88, 92
EDR (Event data recorder).....	10
Electric Power Steering (EPS).....	269
Function.....	269
Warning light.....	687
Warning message.....	702
Electronic key.....	98
Battery-saving function .....	107
If the electronic key does not operate properly .....	740
Replacing the battery .....	646

- Emergency, in case of**
- If the electronic key
    - does not operate properly .....740
  - If the engine will not start.....735
  - If the parking brake
    - cannot be released.....738
  - If the shift lever
    - cannot be shifted from P ..... 737
  - If the vehicle battery is
    - discharged.....743
  - If the warning buzzer
    - sounds.....686
  - If the warning light turns on.....686
  - If the warning message
    - is displayed.....697
  - If you have a flat tire .....722
  - If you think something
    - is wrong.....684
  - If your vehicle becomes
    - stuck .....749
  - If your vehicle needs
    - to be towed .....678
  - If your vehicle overheats .....747
- Emergency flashers.....676**
- Engine**
- Accessory mode.....172
  - Compartment.....615
  - Engine switch.....171
  - Hood.....612
  - How to start the engine .....171
  - Identification number .....753
  - If the engine will not start.....735
  - Ignition switch
    - (engine switch).....171
  - Overheating.....747
- Engine compartment cover.....616**
- Engine coolant .....620**
- Capacity.....756
  - Checking.....620
  - Preparing and checking
    - before winter .....298
- Engine coolant temperature**
- gauge.....79
- Engine immobilizer system.....68**
- Engine oil.....617**
- Capacity.....754
  - Checking.....617
  - Oil level warning message.....706
  - Oil pressure
    - warning message.....698
  - Preparing and checking
    - before winter .....298
- Engine oil maintenance data.....602**
- Engine switch.....171**
- Enhanced VSC.....268**
- EPS**
- (Electronic Power Steering).....269
  - Function.....269
  - Warning light.....687
  - Warning message.....702
- Event data recorder (EDR).....10**

## F

First-aid kit storage net .....	558
Flat tire .....	722
Floor mats .....	26
Fluid	
Automatic transmission .....	757
Brake .....	758
Washer .....	628
Fog lights .....	195
Replacing light bulbs .....	665
Switch .....	195
Wattage .....	761
Footwell light .....	548
Front passenger occupant classification system .....	47
Front personal lights .....	549
Front seats .....	128
Adjustment .....	128
Cleaning .....	598
Correct driving posture .....	28
Driving position memory .....	130
Head restraints .....	136
Power easy access system .....	133
Seat heaters .....	568
Seat position memory .....	130
Seat ventilators .....	569
Front side marker lights .....	190
Light switch .....	190
Replacing light bulbs .....	671
Welcome light illumination control .....	101

Front turn signal lights .....	184
Replacing light bulbs .....	667
Turn signal lever .....	184
Wattage .....	761
Fuel .....	754
Capacity .....	754
Fuel gauge .....	79
Fuel pump shut off system .....	685
Information .....	762
Refueling .....	204
Type .....	204, 754
Warning light .....	689
Warning messages .....	710
Fuel filler door .....	204
If the fuel filler door cannot be opened .....	207
Refueling .....	204
Fuel pump shut off system .....	685
Fuses .....	648

## G

Garage door opener .....	579
Gauges .....	79
Glove box .....	553
Glove box light .....	553

## H

Hands-free system (for cellular phone).....	485
HD Radio® system.....	394
Head restraints.....	136
Headlights.....	190
Adaptive Front-lighting System (AFS).....	192
Discharge headlights precautions.....	673
Headlight leveling warning message.....	700
Light switch.....	190
Replacing light bulbs.....	671
Wattage.....	761
Headlights aim.....	661
Headlights cleaner.....	203
Head-up display.....	90
Heaters	
Air conditioning system.....	345
Heated steering wheel.....	566
Seat heaters.....	568
Outside rear view mirrors.....	365
Hill-start assist control.....	276
Horn.....	189
Hood.....	612
Open.....	612
Warning message.....	704
Hooks	
Cargo hooks.....	558
Coat hooks.....	576
Retaining hooks (floor mat).....	26
Luggage hook.....	558
Utility hook.....	578

## I

I/M test.....	608
Identification	
Engine.....	753
Vehicle.....	753
Ignition switch (engine switch).....	171
Illuminated entry system.....	550
Immobilizer system.....	68
Indicators.....	77
Initialization	
Maintenance.....	602
Moon roof.....	150
Power windows.....	146
Tire pressure warning system.....	631
Initiators (tire pressure warning system).....	637
Inside door handle lights.....	548
Inside rear view mirror.....	140
Instrument panel light control.....	80
Interior lights.....	548
Intuitive parking assist.....	238
Function.....	238
Warning message.....	700, 707

## J

Jack	
Positioning a floor jack.....	613
Vehicle-equipped jack.....	723
Jack handle.....	723
Jam protection function	
Moon roof.....	149
Power trunk opener and closer.....	123
Power windows.....	146

## K

Keyless entry .....	101
Smart access system	
with push-button start .....	101
Wireless remote control .....	114
Keys.....	98
Battery-saving function.....	107
Electronic key .....	98
Engine switch.....	171
If the electronic key	
does not operate properly .....	740
Key number plate .....	98
Keyless entry .....	101, 114
Mechanical key.....	98
Replacing the battery .....	646
Warning buzzer .....	105
Wireless remote control key .....	114
Knee airbags .....	36

## L

Language	
(multi-information display) .....	86
LATCH anchors .....	58
LDH (Lexus Dynamic	
Handling system) .....	269
Lever	
Auxiliary catch lever .....	612
Hood lock release lever .....	612
Internal trunk release lever .....	124
Shift lever .....	178
Turn signal lever .....	184
Wiper lever .....	196
Lexus Dynamic Handling	
system (LDH).....	269

## Lexus Enform \*

Lexus night view .....	293
License plate lights .....	190
Light switch.....	190
Replacing light bulbs .....	671
Welcome light	
illumination control.....	101
Lights	
Fog light switch.....	195
Headlight switch .....	190
Illuminated entry system.....	550
Interior light.....	549
Interior lights list.....	548
Personal lights .....	549
Replacing light bulbs .....	665
Trunk light.....	122
Turn signal lever .....	184
Vanity lights .....	561
Wattage.....	761
Welcome light illumination	
control.....	101

## Light bulbs

Replacing.....	665
Wattage .....	761
LKA (Lane-Keeping Assist) .....	228
Operation.....	229
Warning	
messages .....	700, 707, 708, 709
Lock steering column.....	174
Low profile tire .....	634
Luggage hook .....	558
Luggage security system .....	122

\*: For vehicles with a navigation system, refer to the "Navigation System Owner's Manual".

## M

<b>Maintenance</b>	
Do-it-yourself maintenance.....	609
General maintenance .....	604
Maintenance data.....	752
Maintenance requirements.....	601
<b>Malfunction indicator lamp .....</b>	<b>687</b>
<b>Master warning light .....</b>	<b>689</b>
<b>Meter.....</b>	<b>79</b>
Head-up display.....	90
Indicators.....	77
Instrument panel light control.....	80
Meters.....	79
Multi-information display .....	82
Warning lights .....	75
<b>Micro dust and pollen filter .....</b>	<b>355</b>
<b>Mirrors</b>	
Inside rear view mirror .....	140
Outside rear view mirror	
defoggers .....	365
Outside rear view mirrors.....	142
Vanity mirrors.....	561
<b>Moon roof.....</b>	<b>148</b>
Door lock linked	
moon roof operation.....	149
Jam protection function.....	149
Operation.....	148
Warning message.....	705
<b>MP3 disc.....</b>	<b>414</b>

<b>Multi-information display.....</b>	<b>82</b>
Dynamic radar cruise control.....	213
Lane-Keeping Assist .....	232
Language.....	86
Switching the display .....	83
Trip information.....	83
Warning message.....	697

## N

<b>Navigation system*</b>	
<b>Noise from under vehicle .....</b>	<b>8</b>

## O

<b>Odometer.....</b>	<b>79</b>
<b>Oil</b>	
Engine oil.....	754
Front differential oil .....	758
Rear differential oil .....	758
<b>Opener</b>	
Hood.....	612
Trunk.....	121
<b>Outer foot lights</b>	
Outer foot lights.....	548
Wattage .....	761
<b>Outside rear view mirrors.....</b>	<b>142</b>
Adjusting and folding .....	142
Blind spot monitor .....	287
Linked mirror function	
when reversing.....	143
Mirror position memory .....	130
Outside rear view	
mirror defoggers.....	365
<b>Outside temperature display .....</b>	<b>83</b>
<b>Overheating, Engine.....</b>	<b>747</b>



## P

Paddle shift switches.....	180
Parking assist sensors (intuitive parking assist).....	238
Parking brake.....	186
If the parking brake cannot be released.....	738
Operation.....	186
Parking brake engaged warning buzzer.....	706
Parking brake engaged warning message.....	706
Parking lights.....	190
Light switch.....	190
Replacing light bulbs.....	671
Welcome light illumination control.....	101
PCS (Pre-Collision System).....	278
Function.....	278
PCS OFF switch.....	280
Warning light.....	688
Warning message.....	699, 708, 714
Personal lights.....	549
Power easy access system.....	133
Power outlets.....	564
Power steering (Electric Power Steering system).....	269
Warning light.....	687
Warning message.....	702
Power trunk opener and closer.....	121

Power windows.....	145
Door lock linked window operation.....	147
Jam protection function.....	146
Operation.....	145
Window lock switch.....	145
Pre-Collision System (PCS).....	278
Function.....	278
PCS OFF switch.....	280
Warning light.....	688
Warning message.....	699, 708, 714

## R

Radar cruise control (dynamic radar cruise control).....	213
Radiator.....	622
Radio.....	390
RBDS (Radio Broadcast Data Systems).....	393
Rear air conditioning system.....	360
Rear personal lights.....	549
Rear side marker lights.....	190
Light switch.....	190
Replacing light bulbs.....	671
Welcome light illumination control.....	101
Rear door sunshades.....	573
Rear seat heaters.....	568
Rear sunshade.....	572
Operation.....	572
Reverse operation feature.....	573

\*: For vehicles with a navigation system, refer to the  
"Navigation System Owner's Manual".

Rear turn signal lights .....	184
Replacing light bulbs .....	669
Turn signal lever .....	184
Wattage .....	761
<b>Rear view mirror</b>	
Inside rear view mirror .....	140
Outside rear view mirrors .....	142
<b>Rear view monitor system .....</b>	<b>251</b>
<b>Rear window defoggers .....</b>	<b>365</b>
<b>Refueling .....</b>	<b>204</b>
Capacity .....	754
Fuel types .....	754
If the fuel filler door	
cannot be opened .....	207
Opening the fuel tank cap .....	206
<b>Remote Touch .....</b>	<b>306</b>
<b>Remote Touch screen .....</b>	<b>308</b>
<b>Replacing</b>	
Electronic key battery .....	646
Fuses .....	648
Light bulbs .....	663
Tires .....	722
<b>Reporting safety defects</b>	
for U.S. owners .....	790
<b>Reset the maintenance data .....</b>	<b>602</b>

## S

<b>Safety Connect .....</b>	<b>586</b>
<b>Seat belts .....</b>	<b>30</b>
Adjusting the seat belt .....	31
Automatic Locking Retractor .....	32
Child restraint system	
installation .....	60
Cleaning and maintaining	
the seat belt .....	599
Emergency Locking	
Retractor .....	32
How to wear your seat belt .....	30
How your child should wear	
the seat belt .....	32
Pre-collision seat belts .....	32
Pregnant women, proper	
seat belt use .....	33
Reminder light and buzzer .....	689
Seat belt extender .....	32
Seat belt pretensioners .....	31
SRS warning light .....	687
<b>Seat heaters .....</b>	<b>568</b>
<b>Seat position memory .....</b>	<b>130</b>
<b>Seat ventilators .....</b>	<b>569</b>
<b>Seating capacity .....</b>	<b>168</b>

- Seats**..... 128  
     Adjustment.....128  
     Adjustment precautions..... 129  
     Child seats/child restraint  
         system installation.....57  
     Cleaning.....598  
     Driving position memory..... 130  
     Head restraints..... 136  
     Power easy access system..... 133  
     Properly sitting in the seat.....28  
     Seat heaters.....568  
     Seat position memory.....130  
     Seat ventilators.....569
- Sensor**  
     Automatic headlight system.....193  
     Humidity sensor.....357  
     Inside rear view mirror.....141  
     Intuitive parking assist.....238  
     Lexus night view.....297  
     LKA (Lane-Keeping Assist).....236  
     Radar sensor.....222, 280, 292  
     Rain-sensing windshield  
         wipers.....201
- Service reminder indicators**.....74
- S-FLOW mode**.....355
- Shift lever**.....178  
     Automatic transmission.....178  
     If the shift lever  
         cannot be shifted from P.....737
- Shift lever light**.....548
- Shift lock system**.....737
- Side airbags**.....37
- Side marker lights**.....190  
     Light switch.....190  
     Replacing light bulbs.....671  
     Welcome light illumination  
         control.....101
- Side mirrors**.....142  
     Adjusting and folding.....142  
     Blind Spot Monitor.....287  
     Linked mirror function  
         when reversing.....143  
     Mirror position memory.....130
- Side turn signal lights**.....184  
     Replacing light bulbs.....671  
     Turn signal lever.....184
- Smart access system**  
     **with push-button start**.....101  
         Antenna location.....103  
         Entry functions.....101  
         Starting the engine.....171  
         Warning message.....703
- Snow tires**.....302
- Spare tire**.....722  
     Inflation pressure.....760  
     Storage location.....723
- Spark plug**.....756
- Specifications**.....752
- Speedometer**.....79
- Steering lock**.....174  
     Column lock release.....175  
     Steering lock system  
         warning message.....720
- Steering wheel**.....139  
     Adjustment.....139  
     Audio switches.....482  
     Heated steering wheel.....566  
     Power easy access system.....133  
     Steering wheel  
         position memory.....130
- Stop lights**  
     Replacing light bulbs.....671
- Storage feature**.....551

- Stuck**  
 If the vehicle becomes stuck .....749
- Sun visors**.....561
- Sun shade**  
 Rear.....572  
 Rear door.....573  
 Roof.....149
- Switches**  
 AFS OFF switch.....192  
 Audio remote control  
 switches.....482  
 BSM (Blind spot monitor)  
 switch.....287  
 Cruise control switch.....209  
 "DISP" button.....83  
 Door lock switches.....117  
 Driving mode select switch.....263  
 Driving position memory  
 switches.....130  
 Dynamic radar cruise  
 control switch.....213  
 Emergency flashers switch.....676  
 Engine switch.....171  
 Fog light switch.....195  
 Garage door opener  
 switches.....579  
 Headlight cleaner switch.....203  
 Heated steering wheel  
 switch.....566  
 HUD (Head-up display)  
 switches.....90  
 Ignition switch.....171  
 Intuitive parking assist.....238  
 Lexus night view switch.....293  
 Light switches.....190  
 LKA (Lane-Keeping Assist)  
 switch.....230  
 Moon roof switches.....148  
 Outside rear view mirror  
 switches.....142  
 Paddle shift switches.....180  
 PCS OFF switch.....280  
 Power door lock switch.....117  
 Power window switches.....145  
 Rear sunshade switch.....572  
 Rear window and outside  
 rear view mirror defoggers  
 switch.....365  
 Seat heater switches.....568  
 Seat ventilator switches.....569  
 Snow mode switch.....179  
 "SOS" button.....586  
 Talk switch.....334  
 Telephone switches.....486  
 Tilt and telescopic  
 steering control switch.....139  
 Tire pressure warning reset  
 switch.....632  
 Trunk closer switch.....122  
 Trunk opener switch.....121  
 Trunk opener main switch.....122  
 Vehicle-to-vehicle distance  
 button.....216  
 VSC OFF switch.....270  
 Window lock switch.....145  
 Windshield wipers  
 and washer switch.....196

## T

Tachometer .....	79, 92	Tires .....	629
Tail lights .....	190	Chains .....	300
Light switch .....	190	Checking .....	629
Replacing light bulbs .....	671	If you have a flat tire .....	722
Welcome light illumination control .....	101	Inflation pressure .....	759
Talk switch* .....	334	Information .....	765
Telephone switches* .....	486	Replacing .....	722
Theft deterrent system		Rotating tires .....	630
Alarm .....	70	Size .....	759
Engine immobilizer system .....	68	Snow tires .....	302
Tire inflation pressure .....	759	Spare tire .....	722
Maintenance data .....	759	Tire inflation pressure display function .....	85
Tire inflation pressure display function .....	85	Tire pressure warning system .....	631
Warning light .....	690	Warning light .....	690
Warning message .....	713	Warning message .....	713
Tire information .....	765	Tools .....	723
Glossary .....	772	Top tether strap .....	64
Size .....	768	Total load capacity .....	168
Tire identification number .....	767	Towing	
Uniform Tire Quality Grading .....	770	Dinghy towing .....	170
Tire pressure warning system .....	631	Emergency towing .....	678
Function .....	631	Towing eyelet .....	679
Initializing .....	631	Trailer towing .....	169
Installing tire pressure warning valves and transmitters .....	631	TRAC (Traction Control) .....	268
Registering ID codes .....	633	Transmission .....	178
Tire pressure warning reset switch .....	632	Automatic transmission .....	178
Warning light .....	690	Driving mode select switch .....	263
Warning message .....	713, 714	If the shift lever cannot be shifted from P .....	737
		M mode .....	181
		Paddle shift switches .....	180
		Trip information .....	83
		Trip meters .....	79

\*: For vehicles with a navigation system, refer to the "Navigation System Owner's Manual".

Trunk.....	121
Internal trunk release lever.....	124
Jam protection function.....	123
Luggage security system.....	122
Open trunk warning message... ..	705
Power trunk opener and closer ...	121
Smart access system	
with push-button start.....	102
Trunk closer switch.....	122
Trunk easy closer.....	123
Trunk features.....	558
Trunk handle.....	122
Trunk light.....	122
Trunk opener main switch.....	122
Trunk opener switch.....	121
Trunk storage extension.....	575
Wireless remote control.....	114
Trunk light	
Trunk light.....	122
Wattage.....	761
Turn signal lights.....	184
Replacing light bulbs.....	667, 669
Turn signal lever.....	184
Wattage.....	761

## U

USB port.....	456, 466
Utility hook.....	578

## V

Vanity lights	
Vanity lights.....	561
Wattage.....	761
Vanity mirrors.....	561
Variable Gear Ratio Steering (VGRS).....	268
Function.....	268
Warning message.....	702
VDIM (Vehicle Dynamics Integrated Management).....	269
Vehicle control and operation data recording.....	9
Vehicle Dynamics Integrated Management (VDIM).....	269
Vehicle identification number .....	753
Vehicle Stability Control (VSC).....	268
Ventilators (seat ventilators).....	569
VGRS (Variable Gear Ratio Steering)..	268
Function.....	268
Warning message.....	702
Voice command system.....	334
VSC (Vehicle Stability Control).....	268

## W

<b>Warning buzzers</b>	
Brake system.....	686
Downshifting .....	182
Key reminder .....	717
Open door.....	704
Open moon roof .....	705
Open hood.....	704
Open trunk .....	705
Open window .....	705
Seat belt reminder.....	689
<b>Warning lights .....</b>	<b>75</b>
ABS.....	687
AFS OFF indicator .....	688
Brake system.....	686, 689
Charging system.....	687
Electric power steering.....	687
Low fuel level .....	689
Malfunction indicator lamp.....	687
Master warning light.....	689
Open door .....	689
Parking brake indicator.....	688
Pre-collision system.....	688
Seat belt reminder light.....	689
Slip indicator.....	688
SRS.....	687
Tire pressure .....	690
<b>Warning messages.....</b>	<b>697</b>
<b>Warning reflector storage belt.....</b>	<b>560</b>
<b>Washer .....</b>	<b>196</b>
Checking.....	628
Low washer fluid	
warning message .....	712
Preparing and checking	
before winter .....	298
Switch.....	196
<b>Washing and waxing.....</b>	<b>594</b>

## Weight

Cargo capacity.....	168
Load limits .....	168
Weight.....	752
<b>Welcome light illumination</b>	
control .....	101
<b>Wheels .....</b>	<b>642</b>
Replacing wheels .....	642
Size .....	759
<b>Window glasses.....</b>	<b>145</b>
<b>Window lock switch.....</b>	<b>145</b>
<b>Windows.....</b>	<b>145</b>
Power windows.....	145
Rear window defogger .....	365
<b>Windshield wiper de-icer .....</b>	<b>366</b>
<b>Windshield wipers .....</b>	<b>196</b>
Intermittent windshield	
wipers with interval adjuster.....	196
Position.....	301
Rain-sensing windshield	
wipers.....	198
<b>Winter driving tips .....</b>	<b>298</b>
<b>Wireless remote control key.....</b>	<b>114</b>
Battery-Saving Function .....	107
Locking/Unlocking .....	114
Replacing the battery .....	646
<b>WMA disc.....</b>	<b>414</b>

## X

<b>XM® Satellite Radio.....</b>	<b>398</b>
---------------------------------	------------

# امداد خودرو فارما

تلفن شبانه روزی: ۰۲۱-۸۸۸۶۲۰۸۵

[FarmaSOS.com](http://FarmaSOS.com)



# امداد خودرو فارما

تلفن شبانه روزی: ۰۲۱-۸۸۸۶۲۰۸۵

**FarmaSOS.com**

## GAS STATION INFORMATION

Auxiliary catch lever

P. 612

Trunk opener

P. 121

Fuel filler door

P. 206

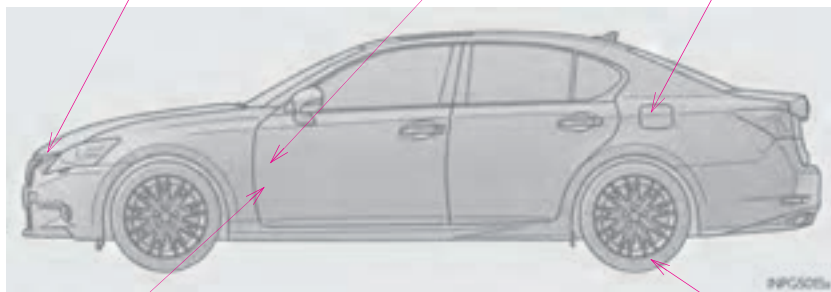

Hood lock release lever

P. 612

Tire inflation pressure

P. 759

Fuel tank capacity  
(Reference)

17.5 gal. (66.3 L, 14.6 Imp.gal.)

Fuel type

Premium unleaded gasoline only

P. 204, 754

Cold tire inflation  
pressure

P. 759

Engine oil capacity  
(Drain and refill –  
reference)

	2WD	AWD
With filter	6.7 (6.3, 5.5)	6.8 (6.4, 5.6)
Without filter	6.2 (5.9, 5.2)	6.3 (6.0, 5.3)

Engine oil type

“Toyota Genuine Motor Oil” or equivalent  
Oil grade: ILSAC GF-5 multigrade engine oil  
Recommended viscosity: SAE 0W-20

P. 754

# امداد خودرو فارما

تلفن شبانه روزی: ۰۲۱-۸۸۸۶۲۰۸۵

[FarmaSOS.com](http://FarmaSOS.com)



Owner's Manual:  
Publication No. OM30C34U  
Part No. 01999-30C34  
Printed in Japan 01-1112-00 [Z]  
GS 350 (北米U)