

TABLE OF CONTENTS

1	Before driving	Adjusting and operating features such as door locks, mirrors, and steering column
2	When driving	Driving, stopping and safe-driving information
3	Interior features	Air conditioning and audio systems, as well as other interior features for a comfortable driving experience
4	Maintenance and care	Cleaning and protecting your vehicle, performing do-it-yourself maintenance, and maintenance information
5	When trouble arises	What to do if the vehicle needs to be towed, gets a flat tire, or is involved in an accident
6	Vehicle specifications	Detailed vehicle information
7	For owners	Reporting safety defects for US owners and seat belt instructions for Canadian owners
	Index	Alphabetical listing of information contained in this manual

1 Before driving

- 1-1. **Key information** 20
 Keys 20
- 1-2. **Opening, closing and locking the doors and trunk** 22
 Smart access system with push-button start 22
 Wireless remote control 34
 Doors 37
 Trunk 42
- 1-3. **Adjustable components (seats, mirrors, steering wheel)** 45
 Front seats 45
 Driving position memory system 47
 Head restraints 51
 Seat belts 53
 Steering wheel 60
 Inside rear view mirror 61
 Outside rear view mirrors 62
- 1-4. **Opening and closing the windows and moon roof** 64
 Power windows 64
 Moon roof 67
- 1-5. **Refueling** 70
 Opening the fuel tank cap 70
- 1-6. **Theft deterrent system** 73
 Immobilizer system 73
 Alarm 75
 Theft prevention labels (U.S.A.) 77
- 1-7. **Safety information** 78
 Correct driving posture 78
 SRS airbags 80
 Front passenger occupant classification system 92
 Child restraint systems 98
 Installing child restraints 102

2 When driving

- 2-1. **Driving procedures** 112
 Driving the vehicle 112
 Engine (ignition) switch 121
 Automatic transmission 125
 Turn signal lever 130
 Parking brake 131
- 2-2. **Instrument cluster** 132
 Gauges and meters 132
 Indicators and warning lights 136
 Multi-information display 139

2-3. Operating the lights and windshield wipers	142
Headlight switch.....	142
Fog light switch.....	145
Windshield wipers and washer.....	146
Headlight cleaner switch.....	149

2-4. Using other driving systems	150
Cruise control.....	150
Dynamic radar cruise control.....	153
Intuitive parking assist.....	164
Rear view monitor system.....	179
AVS (Adaptive Variable Suspension System).....	183
Driving assist systems.....	184
PCS (Pre-Collision System).....	190

2-5. Driving information	194
Cargo and luggage.....	194
Vehicle load limits.....	198
Winter driving tips.....	199
Trailer towing.....	204
Dinghy towing.....	205

3 Interior features

3-1. Using the touch screen	208
Touch screen.....	208
Setting the touch screen.....	212

3-2. Using the air conditioning system and defogger	217
Automatic air conditioning system.....	217
Rear window and outside rear view mirror defoggers.....	225

3-3. Using the audio system	226
Audio system type.....	226
Using the radio.....	229
Using the cassette player.....	238
Using the CD player.....	242
Playing MP3 and WMA discs.....	247
Using the DVD player.....	251
Playing DVD video/audio.....	254
Playing video CD.....	266
DVD player and DVD video disc information.....	270
Optimal use of the audio/video system.....	282
Using the AUX adapter.....	287
Using the steering switches....	288

1

2

3

4

5

6

7

3-4. Using the hands-free system (for cellular phone)..... 291

Hands-free system (for cellular phone)..... 291

Using the Bluetooth® phone 296

Setting the hands-free system 311

3-5. Using the interior lights 337

Interior lights list..... 337

3-6. Using the storage features 340

List of storage features..... 340

3-7. Other interior features..... 347

Sun visors..... 347

Vanity mirror..... 348

Clock..... 349

Outside temperature display 350

Ashtrays 351

Cigarette lighter 352

Power outlet..... 353

Seat heaters/ventilators 354

Armrest 356

Rear sunshade..... 357

Floor mats..... 359

Trunk features..... 360

Garage door opener..... 363

Compass..... 369

Lexus Link System 373

4 Maintenance and care

4-1. Maintenance and care..... 388

Cleaning and protecting the vehicle exterior..... 388

Cleaning and protecting the vehicle interior 391

4-2. Maintenance..... 394

Maintenance requirements 394

General maintenance..... 396

Emission inspection and maintenance (I/M) programs 399

4-3. Do-it-yourself maintenance..... 400

Do-it-yourself service precautions 400

Hood..... 403

Positioning a floor jack..... 404

Engine compartment..... 406

Tires 421

Tire inflation pressure..... 431

Wheels..... 435

Air conditioning filter..... 437

Electronic key battery 440

Checking and replacing fuses..... 442

Headlight aim..... 467

Light bulbs..... 470

5 When trouble arises

5-1. Essential information	478
If your vehicle needs to be towed.....	478
If you think something is wrong	484
Fuel pump shut off system	485
Event data recorder	486
5-2. Steps to take in an emergency	488
If a warning light turns on or a warning buzzer sounds... ..	488
If a warning message is displayed.....	497
If you have a flat tire (Vehicles with standard tires).....	512
If you have a flat tire (Vehicles with run-flat tires)	522
If the engine will not start	523
If the shift lever cannot be shifted from "P"	524
If you lose your keys	525
If the electronic key does not operate properly	526
If the 12 volt battery is discharged	529
If your vehicle overheats	533
If the vehicle becomes stuck.....	536

6 Vehicle specifications

6-1. Specifications	540
Maintenance data (fuel, oil level, etc.).....	540
Fuel information.....	553
Tire information	556
6-2. Customization	569
Customizable features	569
6-3. Initialization	575
Items to initialize	575

7 For owners

Reporting safety defects for U.S. owners.....	578
Seat belt instructions for Canadian owners (in French).....	579

Index

Abbreviation list	582
Alphabetical index.....	584
What to do if.....	594

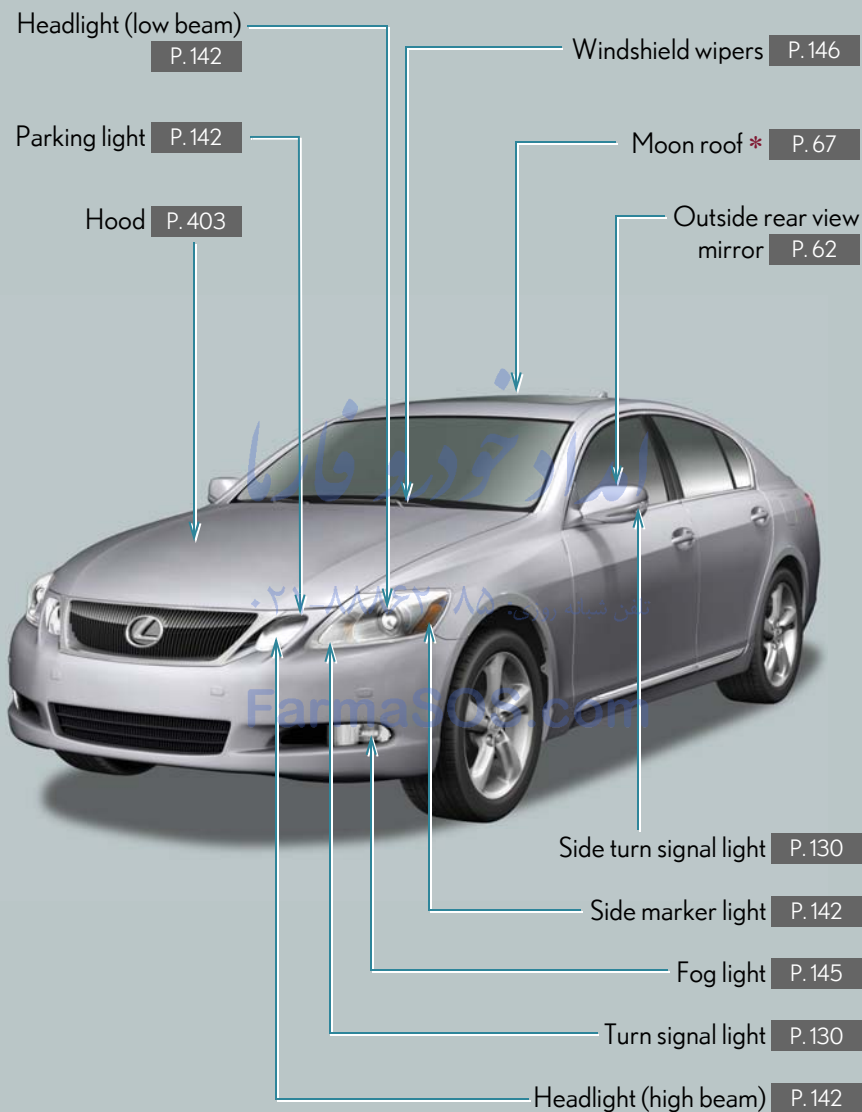

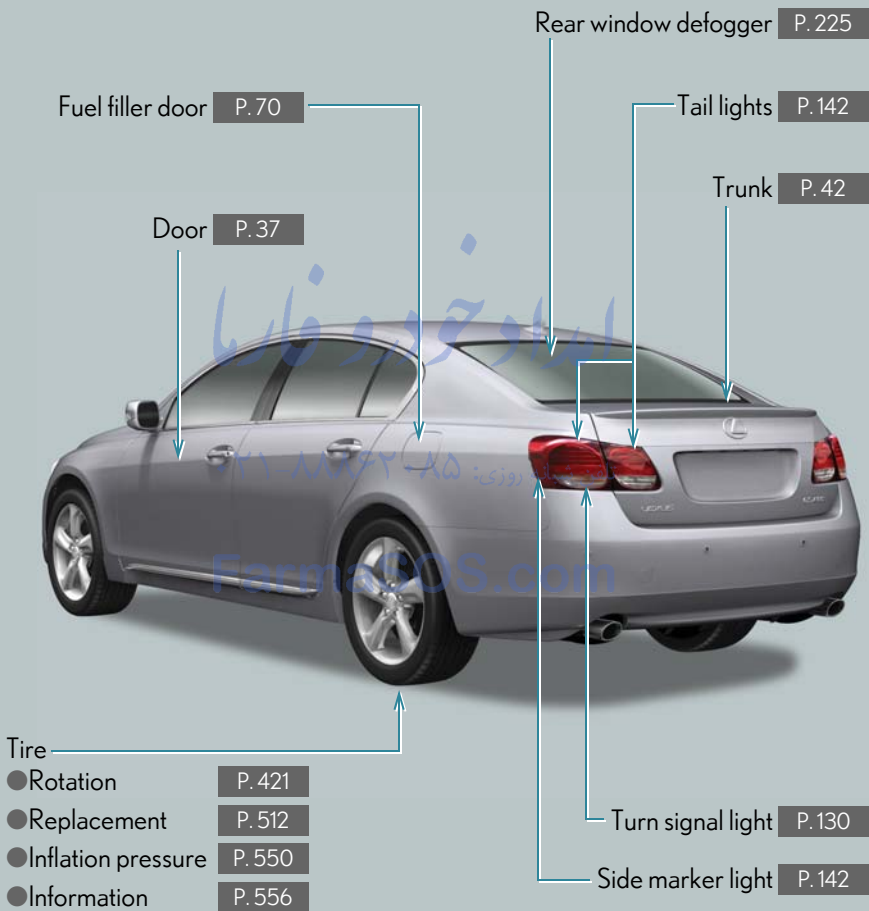

*: If equipped

Pictorial index

Interior

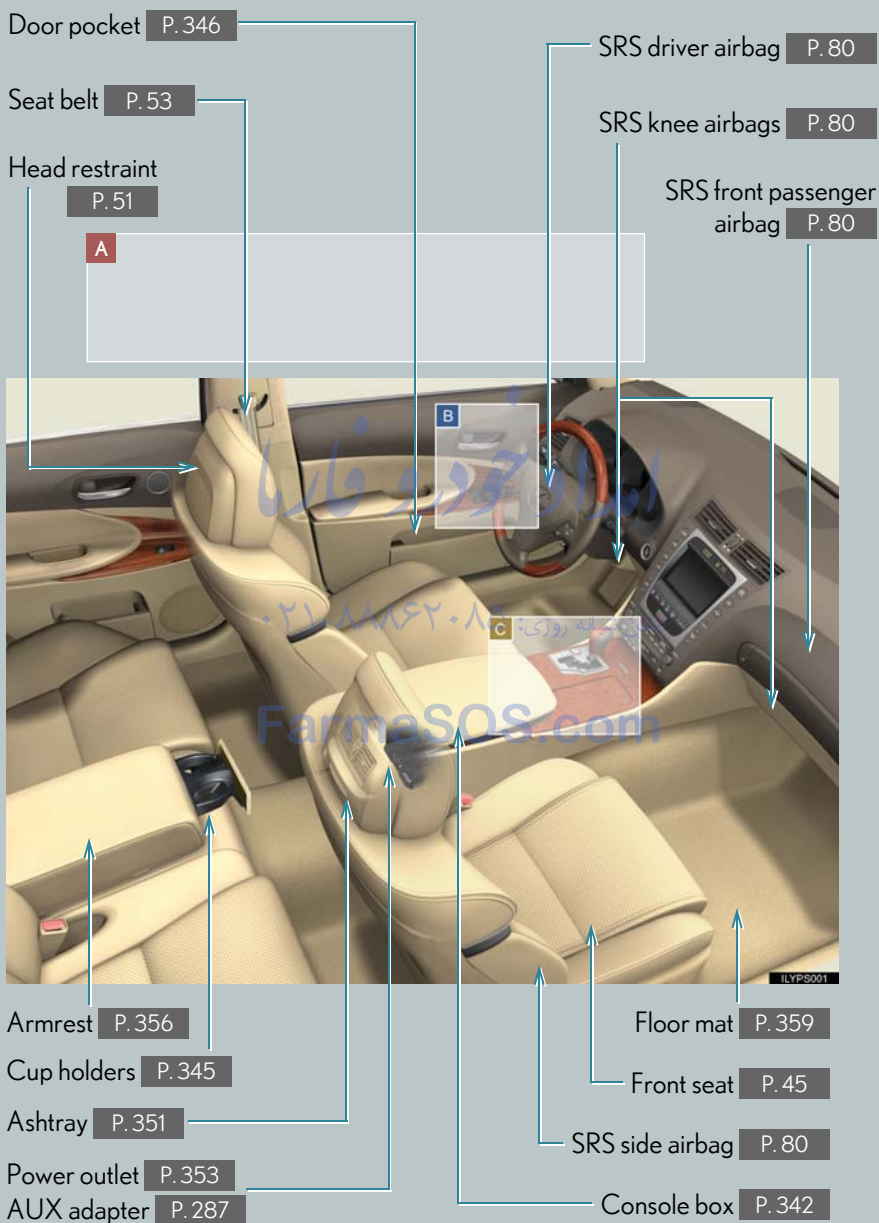

A

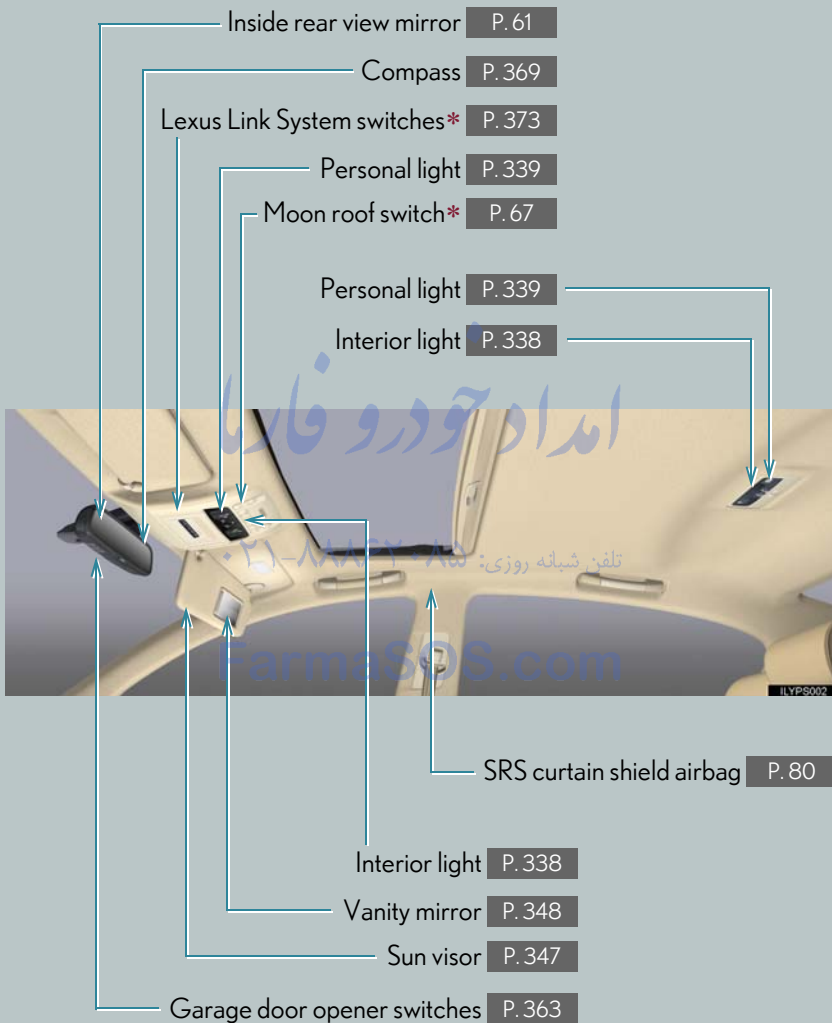

*: If equipped

B

Inside lock button P. 37

Driving position memory switches* P. 47

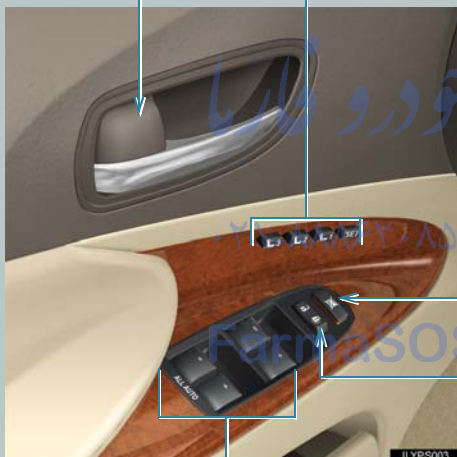

Window lock switch P. 64

Door lock switch P. 37

Power window switches P. 64

C

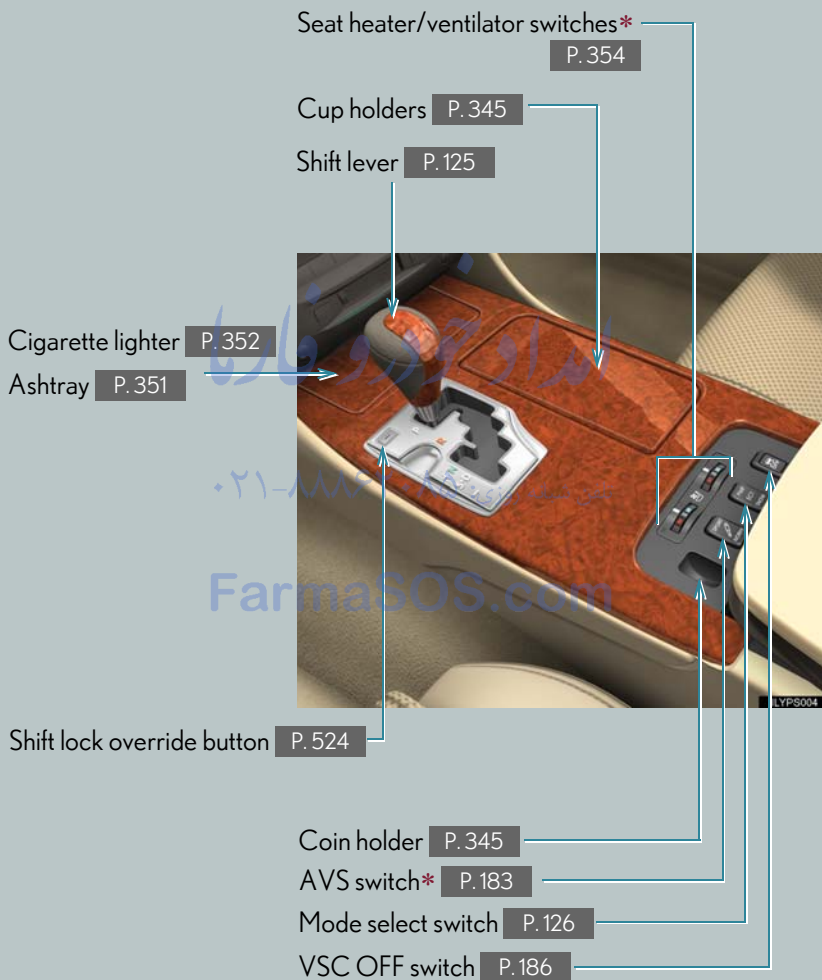

*: If equipped

Pictorial index

Instrument panel

Multi-information display P.139

Gauges and meters P.132

Headlight switch P.142

Turn signal lever P.130

Fog light switch P.145

Windshield wipers and washer switch P.146

Trunk opener main switch P.42

Glove box P.341



"ENGINE START STOP" switch P.121

Trunk opener P.42

Parking brake pedal P.131

Hood lock release lever P.403

Fuel filler door opener P.70

A



*: If equipped

*: Refer to "Navigation System Owner's Manual".

B

Clock P. 349

Outside temperature display

P. 350

Touch screen

P. 208

Navigation system*

Air conditioning system P. 217

Security indicator

P. 73, 75

Audio system

P. 226

Emergency flashers

Rear window and outside rear view mirror defoggers

P. 225

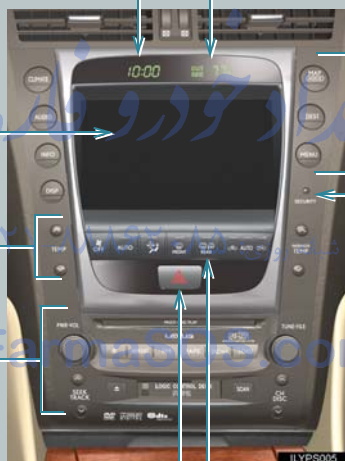

C

Headlight cleaner switch* P.149

Rear sunshade switch* P.357

Intuitive parking assist switch* P.164

"AFS OFF" switch* P.143



Instrument panel light control P.133

Odometer/trip meter and
trip meter reset buttons

P.133

Outside rear view mirror switches P.62

*: If equipped

*: Refer to "Navigation System Owner's Manual".

For your information

Main Owner's Manual

Please note that this manual applies to all models and explains all equipment, including options. Therefore, you may find some explanations for equipment not installed on your vehicle.

All specifications provided in this manual are current at the time of printing. However, because of the Lexus policy of continual product improvement, we reserve the right to make changes at any time without notice.

Depending on specifications, the vehicle shown in the illustration may differ from your vehicle in terms of color and equipment.

Accessories, spare parts and modification of your Lexus

A wide variety of non-genuine spare parts and accessories for Lexus vehicles are currently available in the market. You should know that Toyota does not warrant these products and is not responsible for their performance, repair, or replacement, or for any damage they may cause to, or adverse effect they may have on, your Lexus vehicle.

This vehicle should not be modified with non-genuine Lexus products. Modification with non-genuine Lexus products could affect its performance, safety or durability, and may even violate governmental regulations. In addition, damage or performance problems resulting from the modification may not be covered under warranty.

Installation of a mobile two-way radio system

As the installation of a mobile two-way radio system in your vehicle could affect electronic systems such as the multiport fuel injection system/sequential multiport fuel injection system, cruise control system, vehicle dynamics integrated management, SRS airbag system and seat belt pretensioner system, be sure to check with your Lexus dealer for precautionary measures or special instructions regarding installation.

Scrapping of your Lexus

The SRS airbag and seat belt pretensioner devices in your Lexus contain explosive chemicals. If the vehicle is scrapped with the airbags and seat belt pretensioners left as they are, this may cause an accident such as fire. Be sure to have the systems of the SRS airbag and seat belt pretensioner removed and disposed of by a qualified service shop or by your Lexus dealer before you scrap your vehicle.

Perchlorate Material

Special handling may apply, See www.dtsc.ca.gov/hazardouswaste/perchlorate.

Your vehicle has components that may contain perchlorate. These components may include airbag, seat belt pretensioners, and wireless remote control batteries.

CAUTION

■ General precautions while driving

Driving under the influence: Never drive your vehicle when under the influence of alcohol or drugs that have impaired your ability to operate your vehicle. Alcohol and certain drugs delay reaction time, impair judgment and reduce coordination, which could lead to an accident that will hurt or kill you, your occupants or others.

Defensive driving: Always drive defensively. Anticipate mistakes that other drivers or pedestrians might make and be ready to avoid accidents.

Driver distraction: Always give your full attention to driving. Anything that distracts the driver, such as adjusting controls, talking on a cellular phone or reading can result in a collision with resulting death or serious injury to you, your occupants or others.

■ General precautions regarding children's safety

Never leave children unattended in the vehicle, and never allow children to have or use the key.

Children may be able to start the vehicle or shift the vehicle into neutral. There is also a danger that children may injure themselves by playing with the cigarette lighter, the windows, the moon roof, or other features of the vehicle. In addition, heat build-up or extremely cold temperatures inside the vehicle can be fatal to children.

Symbols used throughout this manual

Cautions & Notices

⚠ CAUTION

This is a warning against anything which may cause injury to people if the warning is ignored. You are informed about what you must or must not do in order to reduce the risk of injury to yourself and others.

⚠ NOTICE

This is a warning against anything which may cause damage to the vehicle or its equipment if the warning is ignored. You are informed about what you must or must not do in order to avoid or reduce the risk of damage to your Lexus and its equipment.

Symbols used in illustrations





Safety symbol

The symbol of a circle with a slash through it means “Do not”, “Do not do this”, or “Do not let this happen”.



Arrows indicating operations

-  Indicates the action (pushing, turning, etc.) used to operate switches and other devices.
-  Indicates the outcome of an operation (e.g. a lid opens).

1-1. Key information	20	1-4. Opening and closing the windows and moon roof	64
Keys	20	Power windows	64
1-2. Opening, closing and locking the doors and trunk	22	Moon roof	67
Smart access system with push-button start	22	1-5. Refueling	70
Wireless remote control	34	Opening the fuel tank cap	70
Doors	37	1-6. Theft deterrent system ...	73
Trunk	42	Immobilizer system	73
1-3. Adjustable components (seats, mirrors, steering wheel)	45	Alarm	75
Front seats	45	Theft prevention labels (U.S.A.)	77
Driving position memory system	47	1-7. Safety information	78
Head restraints	51	Correct driving posture	78
Seat belts	53	SRS airbags	80
Steering wheel	60	Front passenger occupant classification system	92
Inside rear view mirror	61	Child restraint systems	98
Outside rear view mirrors	62	Installing child restraints	102

1-1. Key information

Keys

The following keys are provided with the vehicle.

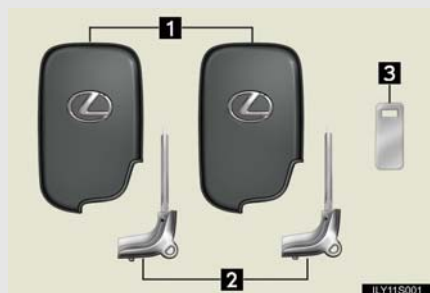

1 Electronic keys

- Operating the smart access system with push-button start (→P. 22)
- Operating the wireless remote control function (→P. 34)

2 Mechanical keys

3 Key number plate

Using the mechanical key



Take out the mechanical key.

After using the mechanical key, store it in the electronic key. Carry the mechanical key together with the electronic key. If the electronic key battery is depleted or the smart access system with push-button start does not operate properly, you will need the mechanical key.

■ When required to leave a key to the vehicle with a parking attendant

Turn the trunk opener main switch OFF and lock the glove box as circumstances demand. (→P. 42, 341)

Remove the mechanical key for your own use and provide the attendant with the electronic key only.

■ Key number plate

Keep the plate in a safe place such as your wallet, not in the vehicle. In the event that a mechanical key is lost, a new key can be made at your Lexus dealer using the key number plate. (→P. 525)

NOTICE

■ To prevent key damage

- Do not disassemble the electronic key.
- Do not subject the keys to strong shocks, expose them to high temperatures by placing them in direct sunlight, or get them wet.
- Do not expose the keys to electromagnetic materials or attach any material that blocks electromagnetic waves to the key surface.

تلفن شبانه روزی: ۰۲۱-۸۸۶۲۰۸۵

FarmaSOS.com

1-2. Opening, closing and locking the doors and trunk Smart access system with push-button start

The following operations can be performed simply by carrying the electronic key on your person, for example in your pocket.

(The driver should always carry the electronic key.)

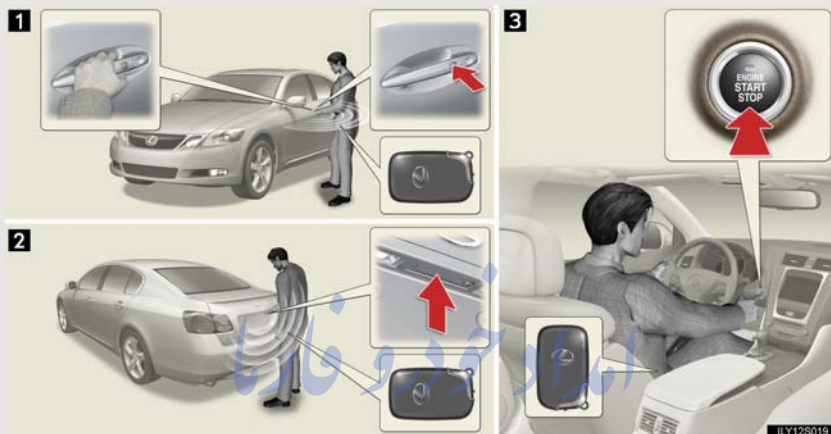

1 Locks and unlocks the doors (→P. 23)

2 Unlocks the trunk (→P. 23) تلفن شبانه روزی: ۰۸۵ ۲۰۸۲۰۲۰۲۰

3 Starts and stops the engine (→P. 121)

FarmaSOS.com

Locking and unlocking the doors



Press the lock button to lock the door.

Press the lock button to lock the door.

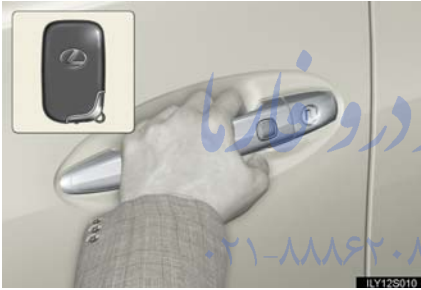

Grip the handle to unlock the door.

Make sure to touch the sensor on the back of the handle.

The door cannot be unlocked for 3 seconds after the door is locked.

تلفن شبانه روزی: ۰۲۱-۸۸۶۲۰۸۵

Unlocking the trunk



Press the button to unlock the trunk.

FarmaSOS.com

Antenna location and effective range

■ Antenna location

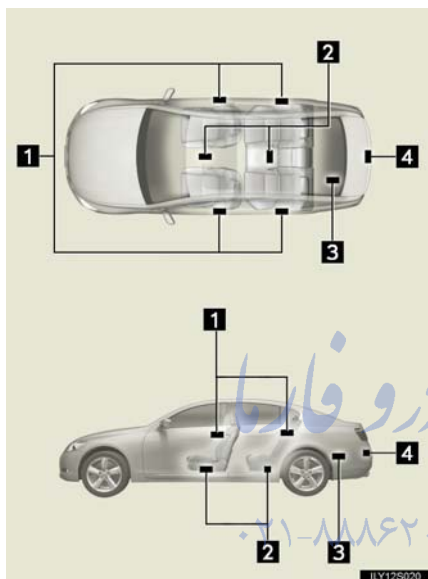

- 1 Antennas outside cabin
- 2 Antennas inside cabin
- 3 Antenna inside trunk
- 4 Antenna outside trunk

امداد خودرو فارما
تلفن شبانه روزی: ۰۸۵-۱۸۸۶۲۰۷۱
FarmaSOS.com

■ Effective range (areas within which the electronic key is detected)

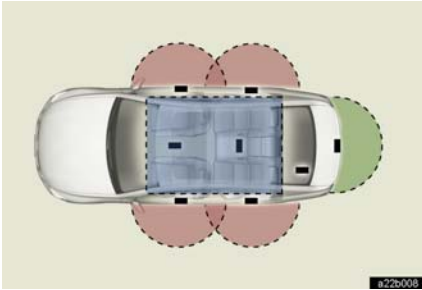

- When locking or unlocking the doors

The system can be operated when the electronic key is within about 2.3 ft. (70 cm) of an outside door handle. (Only the doors detecting the key can be operated.)

- When unlocking the trunk

The system can be operated when the electronic key is within about 2.3 ft. (70 cm) of the trunk release button.

- When starting the engine or changing modes

The system can be operated when the electronic key is inside the vehicle.

ایراد خودرو فارما

تلفن شماره روزی: ۰۲۱-۸۸۶۲۰۸۵

FarmaSOS.com

■ Operation signals

- Doors: A buzzer sounds and the emergency flashers flash to indicate that the doors have been locked/unlocked. (Locked: Once; Unlocked: Twice)
- Windows and moon roof: A buzzer sounds when the windows and moon roof begin to close.

■ Door lock buzzer

If a door is not fully closed, a buzzer sounds continuously if an attempt to lock the door is made. Fully close the door to stop the buzzer, and lock the vehicle once more.

■ Conditions affecting operation





The smart access system with push-button start uses weak radio waves. In the following situations, the communication between key and vehicle may be affected, preventing the smart access system with push-button start and wireless remote control from operating properly. (Way of coping:→P. 526)

- When the electronic key battery is depleted
- Near a TV tower, electric power plant, gas station, radio station, large display, airport or other facility that generates strong radio waves or electrical noise
- When carrying a portable radio, cellular phone, cordless phone or other wireless communication devices
- When the electronic key has come into contact with, or is covered by a metallic object
- When multiple electronic keys are in the vicinity
- When carrying or using the electronic key together with the following devices that emit radio waves
 - Another vehicle's electronic key
 - A wireless key that emits radio waves
 - Personal computer
- If window tint with a metallic content or metallic objects are attached to the rear window





■ Switching the door unlock function

It is possible to set which doors the entry function unlocks using the wireless remote control.

STEP 1 Turn the “ENGINE START STOP” switch OFF.

STEP 2 When the indicator light on the key surface is not on, press and hold , , or  for approximately 5 seconds while pressing and holding .

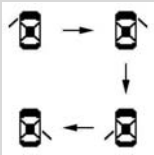
The setting changes each time an operation is performed, as shown below. (When changing the setting continuously, release the buttons, wait for at least 5 seconds, and repeat step 2.)

Multi-information display	Unlocking doors	Beep
	Hold the driver's door handle to unlock only the driver's door	Exterior: Beeps 3 times Interior: Rings once
	Hold a passenger's door handle to unlock all the doors	
	Hold the door handle to unlock the front and rear doors on your side	Exterior: Beeps 4 times Interior: Rings once
	Hold the door handle to unlock the door	Exterior: Beeps once Interior: Rings once
	Hold a door handle to unlock all doors	Exterior: Beeps twice Interior: Rings once

STEP 3 Unlock the doors using the wireless remote control and open one of the doors.

If a door is not opened within 60 seconds after  is pressed, the doors will be locked again and the alarm will automatically be set.

In case that the alarm is triggered, immediately stop the alarm. (→P. 75)

■ Battery-saving function

In the following circumstances, the entry function is disabled in order to prevent the vehicle and electronic key batteries from discharging.

- When the entry function has not been used for 2 months or more
- When the electronic key has been left within approximately 3 ft. (1 m) of the vehicle for 10 minutes or more

The system will resume operation when...

- The vehicle is locked using the door handle lock switch
- The vehicle is locked/unlocked using the wireless remote control function (→P. 34) or the mechanical key (→P. 526)

■ Electronic key battery depletion

- The standard battery life is 1 to 2 years. (The battery becomes depleted even if the electronic key is not used.) If the smart access system with push-button start or the wireless remote control function does not operate, or the detection area becomes smaller, the battery may be depleted. Replace the battery when necessary. (→ P. 440)
- To avoid serious deterioration, do not leave the electronic key within 3 ft. (1 m) of the following electrical appliances that produce a magnetic field:
 - TVs
 - Personal computers
 - Recharging cellular phones or cordless phones
 - Table lamps

■ To operate the system properly

Make sure to carry the electronic key when operating the system. Do not get the electronic key too close to the vehicle when operating the system from the outside of the vehicle.

Depending on the position and holding condition of the electronic key, the key may not be detected correctly and the system may not operate properly. (The alarm may go off accidentally, or the door lock prevention may not function.)

■ Note for the smart access system with push-button start

- Even when the electronic key is within the effective range (detection areas), the system may not operate properly in the following cases.
 - The electronic key is too close to the window or outside door handle, near the ground, or in a high place when the doors are locked or unlocked.
 - The electronic key is near the ground or in a high place, or too close to the rear bumper center when the trunk is unlocked.
 - The electronic key is on the instrument panel, rear package tray or floor, or in the glove box when the engine is started or "ENGINE START STOP" switch modes are changed.
- As long as the electronic key is within the effective range, the doors may be locked or unlocked by anyone.
- Even if the electronic key is not inside the vehicle, it may be possible to start the engine if the electronic key is near the window.
- The doors may unlock if a large amount of water splashes on the door handle, such as in the rain or in a car wash when the electronic key is within the effective range. (The doors will automatically be locked after approximately 60 seconds if the doors are not opened and closed.)

1-2. Opening, closing and locking the doors and trunk

- Gripping the door handle when wearing a glove may not unlock the door.
- If the wireless remote control is used to lock the doors when the electronic key is near the vehicle, there is a possibility that the door may not be unlocked by the smart access system with push-button start. (Use the wireless remote control to unlock the doors.)
- A sudden approach to the effective range or door handle operation may prevent the doors from being unlocked. In this case, return the door handle to the original position and check that the doors unlock before pulling the door handle again.

■ When the vehicle is not driven for extended periods

To prevent theft of the vehicle, do not leave the electronic key within 6 ft. (2 m) of the vehicle.

■ Security feature

If a door is not opened within approximately 60 seconds after the vehicle is unlocked, the theft deterrent system automatically locks the vehicle again.

■ Alarms and warning indicators

A combination of exterior and interior alarms as well as warnings displayed on the multi-information display are used to prevent theft of the vehicle and unforeseeable accidents resulting from erroneous operation. Take appropriate measures in response to any warning indications on the multi-information display. (→P. 508)

The following table describes circumstances and correction procedures when only alarms are sounded.

Alarm	Situation	Correction procedure
Exterior alarm sounds once for 2 seconds	Tried to lock the doors using the entry function while the electronic key is still inside the passenger compartment	Retrieve the electronic key from the passenger compartment and lock the doors again.
	Closed the trunk while the electronic key is still inside and all doors are locked	Retrieve the electronic key from the trunk and close the trunk lid.
Exterior alarm sounds once for 60 seconds	Tried to exit the vehicle with the electronic key and lock the doors without first turning the "ENGINE START STOP" switch OFF	Turn the "ENGINE START STOP" switch OFF and lock the doors again.
Exterior alarm sounds once for 10 seconds	Tried to lock the vehicle using the entry function while a door is open	Close all of the doors and lock the doors again.
Interior alarm sounds continuously	Tried to open the door and exit the vehicle without shifting the shift lever to "P"	Shift the shift lever to "P".
Interior alarm rings continuously	Switched to ACCESSORY mode while the driver's door is open (Opened the driver's door when the "ENGINE START STOP" switch is in ACCESSORY mode.)	Turn the "ENGINE START STOP" switch OFF and close the driver's door.
	Turned the "ENGINE START STOP" switch OFF while the driver's door is open	Close the driver's door.

■ If the smart access system with push-button start does not operate properly

- Locking and unlocking the doors and trunk: Use the mechanical key.
(→P. 526)
- Starting the engine: →P. 527

■ When the electronic key battery is fully depleted

→P. 440

■ Customization that can be configured at Lexus dealer

Settings (e.g. smart access system with push-button start) can be changed.
(Customizable features →P. 569)

■ Certification for the smart access system with push-button start

- ▶ For vehicles sold in the U.S.A.

FCC ID: NI4TMLF-1

NOTE:

This device complies with Part 15 of the FCC Rules. Operation is subject to the following two conditions: (1) this device may not cause harmful interference, and (2) this device must accept any interference received, including interference that may cause undesired operation. تلفن شبانه روزی: ۰۸۵+۲۰۸۸۶۲-۳۳۳۳

FCC WARNING:

Changes or modifications not expressly approved by the party responsible for compliance could void the user's authority to operate the equipment.

- ▶ For vehicles sold in Canada

NOTE:

This device complies with RSS-210 of Industry Canada.

Operation is subject to the following two conditions: (1) this device may not cause interference, and (2) this device must accept any interference, including interference that may cause undesired operation of the device.

⚠ CAUTION**■ Caution regarding interference with electronic devices**

- People with implanted pacemakers or cardiac defibrillators should keep away from the smart access system with push-button start antennas. (→P. 24) The radio waves may affect the operation of such devices. If necessary, the smart access system with push-button start can be disabled. Ask your Lexus dealer for details, such as the frequency of radio waves and timing of emitting the radio waves. Then, consult your doctor to see if you should disable the smart access system with push-button start.
- Users of any electrical medical device other than implanted pacemakers and implanted cardiac defibrillators should consult the manufacturer of the device for information about its operation under the influence of radio waves. Radio waves could have unexpected effects on the operation of such medical devices.

Ask your Lexus dealer for details for disabling the smart access system with push-button start.

تلفن شبانه روزی: ۰۲۱-۸۸۶۲۰۸۵

FarmaSOS.com

1-2. Opening, closing and locking the doors and trunk Wireless remote control

The wireless remote control can be used to lock and unlock the vehicle and the trunk from outside the vehicle.



- 1 Locks all doors
- 2 Unlocks all doors
- 3 Opens the windows and moon roof (push and hold)
- 4 Unlocks the trunk (push and hold)
- 5 Sounds alarm (push and hold) (→P. 76)

■ 2-step unlocking function

When you push the  button, the driver's door is unlocked. Pushing the button again within 3 seconds unlocks the other doors.

■ Operation signals

- Doors: A buzzer sounds and the emergency flashers flash to indicate that the doors have been locked/unlocked. (Locked: Once; Unlocked: Twice)
- Trunk: A buzzer sounds to indicate that the trunk has been unlocked.
- Windows and moon roof: A buzzer sounds to indicate that the windows and moon roof are opening.

■ **Door lock buzzer**

→P. 26

■ **Security feature**

→P. 30

■ **If the wireless remote control does not operate properly**

- Locking and unlocking the doors and trunk: Use the mechanical key. (→P. 526)
- Starting the engine. (→P. 527)

■ **Electronic key battery depletion**

→P. 28

■ **When the electronic key battery is fully depleted**

→P. 440

■ **Conditions affecting operation**

→P. 26

■ **Customization that can be configured at Lexus dealer**

Settings (e.g. 2-step unlocking function, trunk unlocking function) can be changed. (Customizable features →P. 569)

FarmaSOS.com

■ Certification for wireless remote control

- For vehicles sold in the U.S.A

NOTE:

This device complies with Part 15 of the FCC Rules. Operation is subject to the following two conditions: (1) this device may not cause harmful interference, and (2) this device must accept any interference received, including interference that may cause undesired operation.

NOTICE:

This equipment has been tested and found to comply with the limits for a Class B digital device, pursuant to Part 15 of the FCC Rules. These limits are designed to provide reasonable protection against harmful interference in a residential installation. This equipment generates, uses and can radiate radio frequency energy and, if not installed and used in accordance with the instructions, may cause harmful interference to radio communications. However, there is no guarantee that interference will not occur in a particular installation. If this equipment does cause harmful interference to radio or television reception, which can be determined by turning the equipment off and on, the user is encouraged to try to correct the interference by one or more of the following measures:

- Reorient or relocate the receiving antenna.
- Increase the separation between the equipment and receiver.
- Connect the equipment into an outlet on a circuit different from that to which the receiver is connected.
- Consult the dealer or an experienced radio/TV technician for help.

FCC WARNING:

Changes or modifications not expressly approved by the party responsible for compliance could void the user's authority to operate the equipment.

- For vehicles sold in Canada

NOTE:

Operation is subject to the following two conditions: (1) this device may not cause interference, and (2) this device must accept any interference, including interference that may cause undesired operation of the device.

1-2. Opening, closing and locking the doors and trunk

Doors

The vehicle can be locked and unlocked using the smart access system with push-button start, wireless remote control or door lock switch.

■ Smart access system with push-button start

→P. 23

■ Wireless remote control

→P. 34

■ Door lock switch

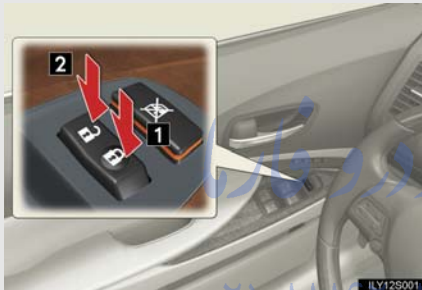

1 Locks all doors

2 Unlocks all doors

■ Inside lock button



1 Locks the door

2 Unlocks the door

The front doors can be opened by pulling the inside handles even if the lock buttons are in the lock position.

Locking the driver's door from the outside without a key

STEP 1 Move the lock button to the lock position.

STEP 2 Close the door.

The door cannot be locked if the "ENGINE START STOP" switch is in the ACCESSORY or IGNITION ON mode, or the electronic key is left inside the vehicle.

The key may not be detected correctly and the door may be locked.

Rear door child-protector lock

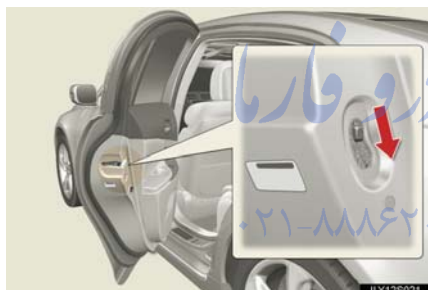

The door cannot be opened from inside the vehicle when the locks are set.

These locks can be set to prevent children from opening the rear doors. Push down rear door switches to lock the rear doors.

FarmaSOS.com

Automatic door locking and unlocking systems

The following functions can be set or canceled:

Function	Operation
Shift position linked door locking function	Shifting the shift lever out of "P" locks all doors.
Shift position linked door unlocking function	Shifting the shift lever to "P" unlocks all doors.
Speed linked door locking function	All doors are locked when the vehicle speed is approximately 12 mph (20 km/h) or higher.
Driver's door linked door unlocking function	All doors are unlocked when the driver's door is opened within 10 seconds after turning the "ENGINE START STOP" switch OFF.

Setting and canceling the functions

To switch between setting and canceling, follow the procedure below:

STEP 1 Close all the doors and switch the "ENGINE START STOP" switch to IGNITION ON mode. (Perform step 2 within 10 seconds.)

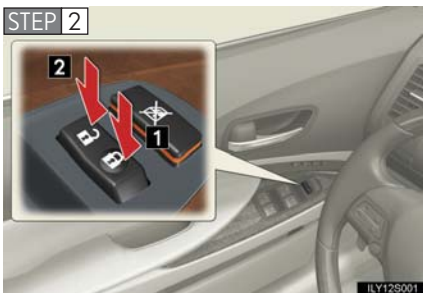

Shift the shift lever to "P" or "N", press and hold the driver's door lock switch (1 or 2) for approximately 5 seconds then release.

The shift lever and switch positions corresponding to the desired function to be set or canceled are shown as follows.

1-2. Opening, closing and locking the doors and trunk

Function	Shift lever position	Switch position
Shift position linked door locking function	"P"	1
Shift position linked door unlocking function		2
Speed linked door locking function	"N"	1
Driver's door linked door unlocking function		2

When the setting or canceling operation is complete, all doors are locked and then unlocked.

■ Closing the front doors from outside with the inside lock button set in the locked position

The door cannot be locked if the "ENGINE START STOP" switch is in ACCESSORY or IGNITION ON mode, or the electronic key is left in the vehicle. (However, depending on the key's location, the system may not be able to detect it. In these instances the door lock protection function will not operate properly.)

■ Using the mechanical key

The doors can also be locked and unlocked with the mechanical key. (→P. 526)

■ Customization that can be configured at Lexus dealer

Settings (e.g. unlocking function using a key) can be changed. (Customizable features →P. 571)

 CAUTION**■ To prevent an accident**

Observe the following precautions while driving the vehicle.

Failing to do so may result in a door opening and an occupant falling out, resulting in death or serious injury.

- Always use a seat belt.
- Always lock all doors.
- Ensure that all doors are properly closed.
- Do not pull the inside handle of the front door while driving.
The doors will open even if it is locked.
- Set the rear door child protector locks when children are seated in the rear seat.

امداد خودرو فارما

تلفن شبانه روزی: ۰۲۱-۸۸۶۲۰۸۵

FarmaSOS.com

1-2. Opening, closing and locking the doors and trunk

Trunk

The trunk can be opened using the trunk opener, smart access system with push-button start or wireless remote control.

■ Trunk opener



Press the opener switch.

■ Smart access system with push-button start

→P. 23

■ Wireless remote control

→P. 34

تلفن شبانه روزی: ۰۲۱-۸۸۶۲۰۸۵

Canceling the trunk opener feature

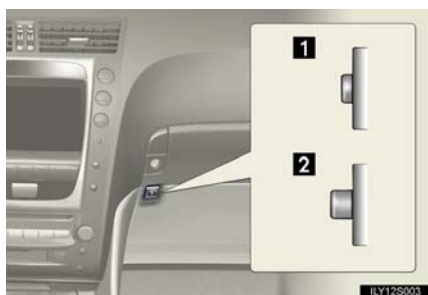

Turn the main switch in the glove box OFF to disable the trunk opener.

1 ON

2 OFF

The trunk lid cannot be opened even with the wireless remote control or the smart access system with push-button start.

■ Trunk easy closer

In the event that the trunk lid is left slightly open (not latched properly), the trunk easy closer will automatically close it to the fully closed position.

■ Trunk light

When the trunk light switch is set to ON, the trunk light turns on when the trunk is opened.

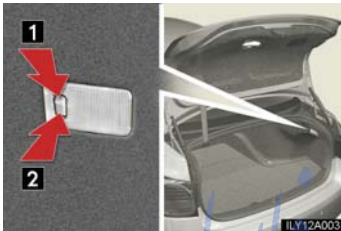

- 1 ON
- 2 OFF

■ Trunk handle



Use the trunk handle when closing the trunk.

■ Internal trunk release lever



The trunk lid can be opened by pulling down on the glow-in-the-dark lever located on the inside of trunk lid.

The lever will continue to glow for some time after the trunk lid is closed.

■ Using the mechanical key

The trunk can be also opened using the mechanical key. (→P. 526)

امداد خودرو فارما
تلفن شبانه روزی: ۰۸۵۰۱۶۲۰۸۵
FarmaSOS.com

CAUTION

■ While driving

Keep the trunk lid closed.

This not only keeps personal belongings from being thrown out, but also prevents exhaust gases from entering the vehicle.

■ When children are in the vehicle

- Never leave children unattended in the vehicle as they may lock themselves in the vehicle or trunk, which could cause the child to overheat or suffocate, resulting in death or serious injury.

- Do not allow a child to open or close the trunk lid. Doing so may cause the trunk lid to operate unexpectedly and part of the child's body may become caught.

■ Trunk easy closer

When the trunk lid is not completely closed, the trunk easy closer will automatically close it. Be careful not to catch fingers or anything else in the trunk lid. Failure to do so may result in serious injury.

NOTICE

تلفن شبانه روزی: ۰۲۱-۸۸۶۲۰۸۵

■ To avoid damage to the trunk easy closer

Do not apply force when the closer is operating.

1-3. Adjustable components (seats, mirrors, steering wheel)

Front seats

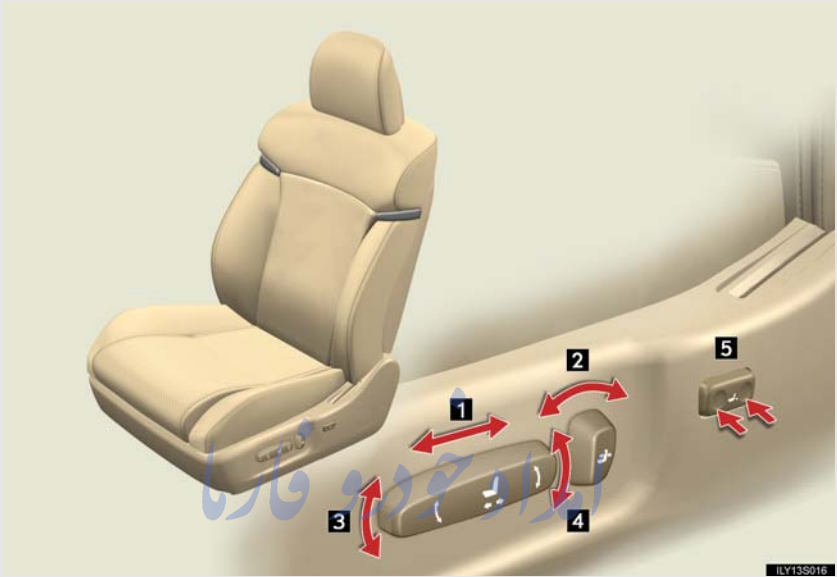

1 Seat position fore/aft control switch

For driver's seat only: Height of the head restraint also moves upward or downward with the seat movement.

2 Seatback angle control switch

3 Seat cushion (front) angle control switch

4 Vertical height control switch

5 Lumbar support control switch

 CAUTION

■ Reclining adjustment

Do not recline the seat more than necessary when the vehicle is in motion, to reduce the risk of sliding under the lap belt.

If the seat is too reclined, during an accident the lap belt may slide past the hips and apply restraint forces directly to the abdomen or your neck may contact the shoulder belt, increasing the risk of death or serious injury.

امداد خودرو فارما

تلفن شبانه روزی: ۰۲۱-۸۸۶۲۰۸۵

FarmaSOS.com

1-3. Adjustable components (seats, mirrors, steering wheel)

Driving position memory system (if equipped)

Your preferred driving position (the position of the driver's seat, steering wheel and outside rear view mirrors) can be entered into the computer's memory and recalled with the touch of a button. It is also possible to set this function to activate automatically when the doors are unlocked.

Three different driving positions can be entered into memory.

The same buttons are found on the front passenger's side, allowing the position of the front passenger's seat to be memorized.

■ Entering a position to memory

Check that the shift lever is set in "P".

STEP 1 Turn the "ENGINE START STOP" switch to IGNITION ON mode.

STEP 2 Adjust the driver's seat, steering wheel, and outside rear view mirrors to the desired positions.

STEP 3



While pushing the "SET" button, push button "1", "2" or "3" until the signal beeps.

If the selected button has already been preset, the previously recorded position will be overwritten.

■ Recalling the memorized position

Check that the shift lever is set in "P".

STEP 1 Turn the "ENGINE START STOP" switch to IGNITION ON mode.

STEP 2



Push button "1", "2" or "3" to recall the memorized position.

■ Linking driving position memory with door unlock operation (driver side only)

Memorized driving positions can be recalled when you unlock the driver's door using the entry function or wireless remote control and open the driver's door. Steering wheel position is recalled when the "ENGINE START STOP" switch is set to the IGNITION ON mode.

■ Setting the linked door unlock operation

STEP 1 Set the driving positions into the memory system using the "1", "2" or "3" buttons on the driver's side. (→P. 47)

STEP 2 Turn the "ENGINE START STOP" switch to the OFF, then close the driver's door.

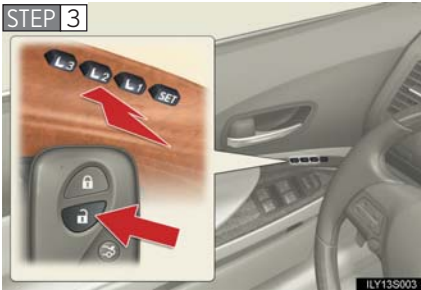

Push the “1”, “2” or “3” button on the driver’s side and the  button on the wireless remote control at the same time for about 1 second until you hear a beep.

STEP 4 Open one of the doors.

If a door is not opened within 60 seconds after  is pressed, the doors will be locked again and the alarm will automatically be set. In case that the alarm is triggered, immediately stop the alarm. (→P. 75)

■ Canceling the linked door unlock operation

STEP 1 Close the driver’s door with the “ENGINE START STOP” switch set to the OFF. *تلفن شبانه روزی: ۰۲۱-۸۸۶۲۰۸۵*

STEP 2 Push the “SET” button and the  button on the wireless remote control at the same time for about 1 second until you hear 2 beeps.

■ Retained accessory power

Each memorized position (except for the tilt and telescopic steering column) can be activated within 30 seconds after the corresponding side door is opened, even if the “ENGINE START STOP” switch is in the OFF.

■ If any position memory button is pushed while the adjustments are being made

The operation will stop. To reactivate the system, push the desired button (“1” or “2”) again.

■ If the 12 volt battery is disconnected

The memorized positions must be reset because the computer’s memory is erased when the 12 volt battery is disconnected.

 CAUTION

■ **Seat adjustment caution**

Take care during seat adjustment that the seat does not strike the rear passenger or squeeze your body against the steering wheel.

If this happens, you can stop the movement by pressing another driving position memory button.

امداد خودرو فارما

تلفن شبانه روزی: ۰۲۱-۸۸۸۶۲۰۸۵

FarmaSOS.com

Head restraints

■ Vertical adjustment

▶ Driver's seat

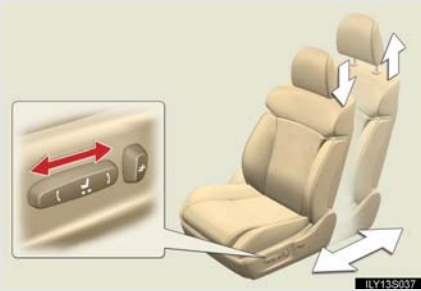

Head restraint height can be adjusted automatically along with the seat position adjustment. (→P. 45)

▶ Front passenger's and rear seats

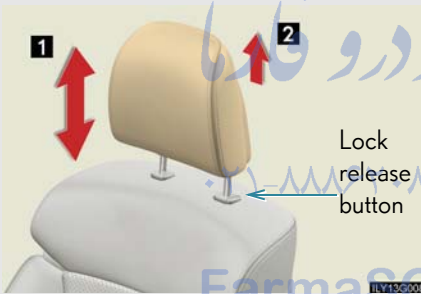

1 Grip head restraint and move it up or down.

Push and hold the lock release button when lowering the head restraint.

2 Grip head restraint and remove while holding the lock release button.

■ Horizontal adjustment

▶ Front and outboard rear seats

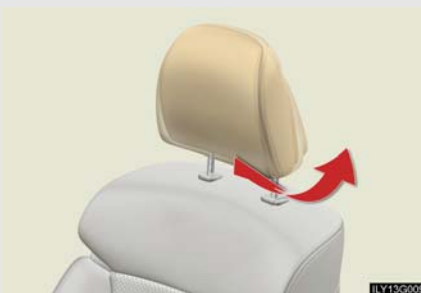

Grip head restraint and twist to tilt forward or backward.

■ Adjusting the height of the driver's head restraint manually

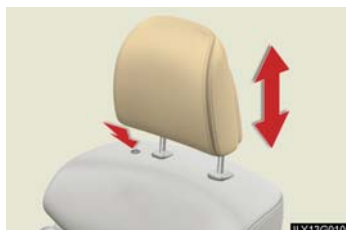

Push and hold the lock release button when lowering or raising the head restraint.

■ Removing the driver's seat head restraint

For removal and installation, ask your Lexus dealer.

■ Adjusting the height of the head restraints

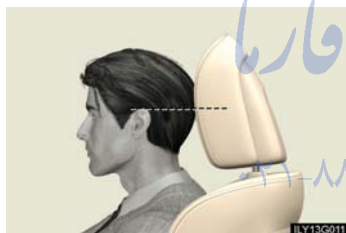

Make sure that the head restraints are adjusted so that the center of the head restraint is closest to the top of your ears.

■ Adjusting the center rear seat head restraint

Always raise the head restraint one level from the stowed position when using.

⚠ CAUTION

■ Head restraint precautions

Observe the following precautions regarding the head restraints. Failure to do so may result in death or serious injury.

- Use the head restraint designed for each respective seat.
- Adjust the head restraints to the correct position at all times.
- Do not drive with the head restraints removed.

Seat belts

Make sure that all occupants are wearing their seat belts before driving the vehicle.

■ Correct use of the seat belts



- 1 Extend the shoulder belt so that it comes fully over the shoulder, but does not come into contact with the neck or slide off the shoulder.
- 2 Position the lap belt as low as possible over the hips.
- 3 Adjust the position of the seatback. Sit up straight and well back in the seat.
- 4 Do not twist the seat belt.

■ Fastening and releasing the seat belt

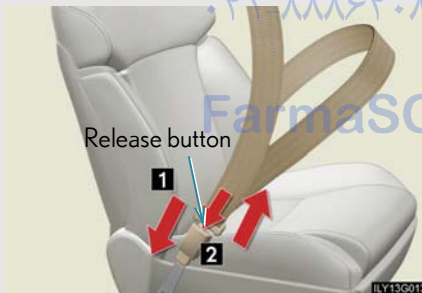

- 1 Fastening the belt
Push the tab into the buckle until a clicking sound is heard.
- 2 Releasing the belt
Press the release button.

Pre-collision seat belts (front seats of vehicles with pre-collision system)

When the pre-collision sensor detects an obstacle and determines that a collision is unavoidable, the seat belts lessen collision injury by retracting the slack in the front seat belts before the collision, thus restraining the driver and passenger at an earlier stage.

The seat belts will also operate in the event of sudden braking. (→P. 190)

■ Emergency locking retractor (ELR)

The retractor will lock the belt during a sudden stop or on impact. It may also lock if you lean forward too quickly. A slow, easy motion will allow the belt to extend, and you can move around fully.

■ Automatic locking retractor (ALR)

When a passenger's shoulder belt is completely extended and then retracted even slightly, the belt is locked in that position and cannot be extended. This feature is used to hold the child restraint system (CRS) firmly. To free the belt again, fully retract the belt and then pull the belt out once more. (→P. 102)

■ Pregnant women



Obtain medical advice and wear the seat belt in the proper way. (→P. 53)

Women who are pregnant should position the lap belt as low as possible over the hips in the same manner as other occupants. Extend the shoulder belt completely over the shoulder and position the belt across the chest. Avoid belt contact over the rounding of the abdominal area.

If the seat belt is not worn properly, not only a pregnant woman, but also the fetus could suffer death or serious injury as a result of sudden braking or a collision.

■ People suffering illness

Obtain medical advice and wear the seat belt in the proper way. (→P. 53)

■ Child seat belt usage

The seat belts of your vehicle were principally designed for persons of adult size.

- Use a child restraint system appropriately for the child, until the child become large enough to properly wear the vehicle's seat belt. (→P. 98)
- When the child becomes large enough to properly wear the vehicle's seat belt, follow the instructions on P. 53 regarding seat belt usage.

■ Replacing the belt after the pretensioner has been activated

If the vehicle is involved in multiple collisions, the pretensioner will activate for the first collision, but will not activate for the second or subsequent collisions.

■ Seat belt extender



If your seat belts cannot be fastened securely because they are not long enough, a personalized seat belt extender is available from your Lexus dealer free of charge.

تلفن شبانه روزی: ۰۲۱-۸۸۶۲۰۸۵

FarmaSOS.com

! CAUTION

Observe the following precautions to reduce the risk of injury in the event of sudden braking or an accident. Failing to do so may cause death or serious injury.

■ Wearing a seat belt

- Ensure that all passengers wear a seat belt.
- Always wear a seat belt properly.
- Each seat belt should be used by one person only. Do not use a seat belt for more than one person at the same time, including children.
- Lexus recommends that children should be seated in the rear seat and always use a seat belt and/or an appropriate child restraint system.
- Do not recline the seat any more than necessary to achieve a proper seating position. The seat belt is most effective when the occupants are sitting up straight and well back in the seats.
- Do not wear the shoulder belt under your arm.
- Always wear your seat belt low and snug across your hips.

■ Adjustable shoulder anchor

Always make sure the shoulder belt is positioned across the center of your shoulder. The belt should be kept away from your neck, but not falling off your shoulder. Failure to do so could reduce the amount of protection in an accident and cause death or serious injuries in a collision. (→P. 54)

■ Seat belt pretensioners

- Do not place anything, such as a cushion, on the front passenger's seat. Doing so will disperse the passenger's weight, which prevents the sensor from detecting the passenger's weight properly. As a result, the seat belt pretensioner for the front passenger's seat may not activate in the event of a collision.
- If the pretensioner has activated, the seat belt becomes locked: it cannot be further extended, nor will it return to the stowed position. The seat belt cannot be used again and must be replaced at your Lexus dealer.

CAUTION

■ Seat belt damage and wear

- Do not damage the seat belts by allowing the belt, plate or buckle to be jammed in the door.
- Inspect the seat belt system periodically. Check for cuts, fraying, and loose parts. Do not use a damaged seat belt until it is replaced. Damaged seat belts cannot protect an occupant from injury.
- Ensure that the belt and tab are locked and the belt is not twisted. If the seat belt does not function correctly, immediately contact your Lexus dealer.
- Replace the seat assembly, including the belts, if your vehicle has been involved in a serious accident, even if there is no obvious damage.
- Do not attempt to install, remove, modify, disassemble or dispose of a seat belt. Have any necessary repairs carried out by your Lexus dealer. Inappropriate handling of the pretensioner may cause it to activate or operate improperly and may cause death or serious injury.

■ Using a seat belt extender

- Do not wear the seat belt extender, if you can fasten the seat belt without the extender.
- Do not use the seat belt extender when installing a child restraint system, because the belt will not securely hold the child restraint system, increasing the risk of death or injury in the event of a collision.
- The personalized extender may not be safe on another vehicle, when used by another person, or at a different seating position other than the one originally intended.

■ Precaution for pre-collision seat belts

Do not rely solely on the pre-collision system to avoid accidents. Always pay attention to the surrounding conditions, and drive safely and responsibly.

 NOTICE

■ **When using a seat belt extender**

When releasing the seat belt, press on the buckle release button on the extender, not on the seat belt.

This helps prevent damage to the vehicle interior and the extender itself.

1

Before driving

امداد خودرو فارما

تلفن شبانه روزی: ۰۲۱-۸۸۸۶۲۰۸۵

FarmaSOS.com

1-3. Adjustable components (seats, mirrors, steering wheel)

Steering wheel

The steering wheel can be adjusted to a comfortable position while the “ENGINE START STOP” switch is in ACCESSORY or IGNITION ON mode.

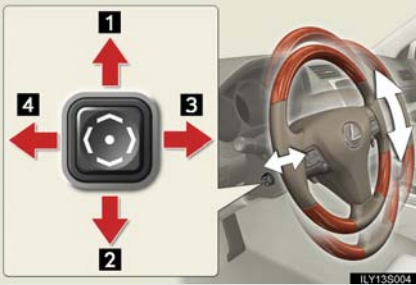

- 1 Up
- 2 Down
- 3 Toward the driver
- 4 Away from the driver

Auto tilt away and auto return



When the “ENGINE START STOP” switch is turned OFF, the steering wheel returns to its stowed position by moving up and away to enable easier driver entry and exit.

Switching to ACCESSORY or IGNITION ON mode will return the steering wheel to the original position.

⚠ CAUTION

■ While driving

Do not adjust the steering wheel.

Doing so may cause the driver to mishandle the vehicle and an accident, resulting in death or serious injury.

1-3. Adjustable components (seats, mirrors, steering wheel)

Inside rear view mirror

In the auto mode, sensors are used to detect the headlights of vehicles behind and automatically reduces the reflected light.

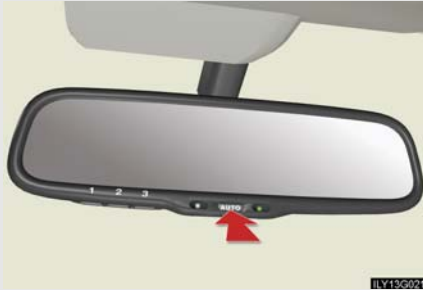

Turns auto mode on/off

The indicator comes on when auto mode is turned on.

The mirror is automatically set to auto whenever the "ENGINE START STOP" switch is turned IGNITION ON mode.

■ To prevent sensor error



To ensure correct functioning of the sensors, do not touch or cover the sensors.

⚠ CAUTION

■ While driving

Do not adjust the position of the mirror.

Doing so may lead to mishandling of the vehicle and an accident, or resulting in death or serious injury.

1-3. Adjustable components (seats, mirrors, steering wheel)

Outside rear view mirrors

Mirror angle can be adjusted using the switch when the “ENGINE START STOP” switch is in ACCESSORY or IGNITION ON mode.

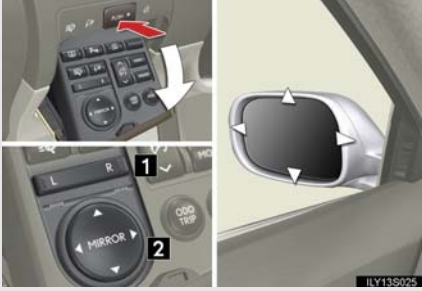

- 1 Select the mirror to adjust (“L”: left or “R”: right)
- 2 Adjust the mirror up, down, in, or out using the switch

Folding the mirrors

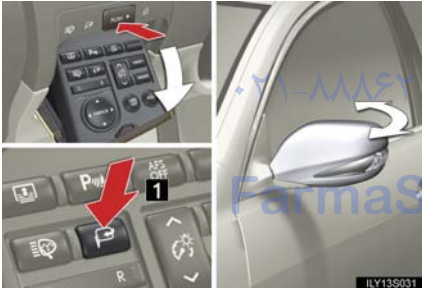

- 1 Press the switch

Pressing again will extend the mirrors.
تلفن شبانه ۰۲۱-۸۸۶۲۰۸۵

■ When the mirrors are fogged up

Turn on the mirror heaters to defog the mirrors. (→P. 225)

■ Auto anti-glare function

When the inside rear view mirror is set to auto mode, the outside rear view mirrors will activate in conjunction with the inside rear view mirror to reduce reflected light. (→P. 61)

■ Linked mirror function when reversing

The outside rear view mirrors will automatically angle downwards when the vehicle is reversing in order to give a better view of the ground. However, this function will not operate when the mirror select switch is in the neutral position (neither "L" nor "R" selected).

■ One-touch adjustment of the mirror angle (vehicles with driving position memory)

A desired mirror face angle can be entered to memory and adjusted with the touch of a button. (→P. 47)

⚠ CAUTION

■ While driving

Observe the following precautions.

Failing to do so may result in losing control of the vehicle and cause an accident, resulting in death or serious injury.

- Do not adjust the mirrors.
- Do not drive with the mirrors folded back.
- Before driving, be sure to extend mirrors and make an adjustment properly.

■ When a mirror is moving

To avoid injury and mirror malfunction, be careful not to get your hand caught by the moving mirror.

■ When the mirror heaters are operating

Do not touch the mirror surface as the mirror surface becomes hot.

1-4. Opening and closing the windows and moon roof

Power windows

The power windows can be opened and closed using the following switches.



- 1 Closing
- 2 One-touch closing*
- 3 Opening
- 4 One-touch opening*

*: Pushing the switch in the opposite direction will stop window travel partway.

Lock switch



Press the switch down to lock passenger window switches.

Use this switch to prevent children from accidentally opening or closing a passenger window.

■ The power windows can be operated when

The “ENGINE START STOP” switch is in IGNITION ON mode.

■ Linked door lock window operation

● The power windows can be opened and closed using the mechanical key.
(→P. 526)

● The power windows can be opened using the wireless remote control.
(→P. 34)

● The power windows can be closed using the smart access system with push-button start. (→P. 22)

■ Operating the power windows after turning the “ENGINE START STOP” switch OFF

The power windows can be operated for approximately 45 seconds even after the “ENGINE START STOP” switch is switched to ACCESSORY mode or turned OFF. They cannot, however, be operated once the driver’s or front passenger’s door is opened.

■ Jam protection function

If an object becomes caught between the window and the window frame, window travel is stopped and the window is opened slightly.

■ Customization that can be configured at Lexus dealer

Settings (e.g. linked door lock operation) can be changed.
(Customizable features →P. 571)

 CAUTION

■ **When closing the windows**

Observe the following precautions.

Failing to do so may result in death or serious injury.

- Check to make sure that all passengers do not have any part of their body in a position where it could be caught when a window is being operated.
- Do not allow children to operate the power windows.
Closing a power window on someone can cause death or serious injury.

■ **Jam protection function**

- Never try jamming any part of your body to activate the jam protection function intentionally.
- The jam protection function may not work if something gets caught just before the window fully closes.

تلفن شبانه روزی: ۰۲۱-۸۸۶۲۰۸۵

FarmaSOS.com

1-4. Opening and closing the windows and moon roof Moon roof (if equipped)

Use the overhead switches to open, close, and tilt the moon roof up and down.

■ Opening and closing

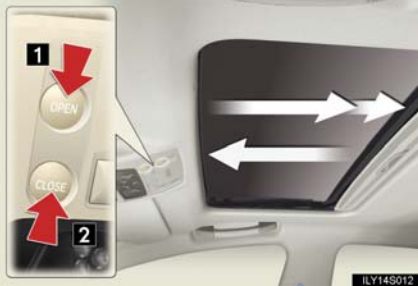

1 Open

Stops just before it is opened fully. Press the switch again to fully open.

2 Close

To stop partway, press the switch lightly.

■ Tilt up and down



1 Tilt up

2 Tilt down

To stop partway, press the switch lightly.

امداد خودرو فارما
تلفن شماره رزرو: ۰۲۱-۸۸۸۶۰۵۵
FarmaSOS.com

■ The moon roof can be operated when

The “ENGINE START STOP” switch is in IGNITION ON mode.

■ Linked door lock moon roof operation

- The moon roof can be opened and closed using the mechanical key. (→P. 526)
- The moon roof can be opened using the wireless remote control. (→P. 34)
- The moon roof can be closed using the smart access system with push-button start. (→P. 22)

■ Operating the moon roof after turning the “ENGINE START STOP” switch OFF

The moon roof can be operated for approximately 45 seconds even after the “ENGINE START STOP” switch is switched to ACCESSORY mode or turned OFF. It cannot, however, be operated once the driver’s door is opened.

■ Jam protection function

If an object is detected between the moon roof and the frame while closing or tilting down, travel is stopped and the moon roof opens slightly.

■ If the moon roof cannot be closed automatically

Keep the close switch depressed. تلفن شبانه روزی: ۰۸۵ ۰۸۸۶۲ ۰۲۲

■ To reduce moon roof wind noise

Drive with the moon roof opened automatically (just before fully opened position).

■ Sunshade

The sunshade can be opened and closed manually. However, the sunshade will open automatically when the moon roof is opened.

■ Customization that can be configured at Lexus dealer

Settings (e.g. linked door lock operation) can be changed.
(Customizable features →P. 571)

⚠ CAUTION**■ When opening the moon roof**

Observe the following precautions.

Failing to do so may cause death or serious injury.

- Do not allow any passengers to put their hands or heads outside the vehicle while it is moving.
- Do not sit on top of the moon roof.

■ When closing the moon roof

Observe the following precautions.

Failing to do so may result in death or serious injury.

- Check to make sure that all passengers do not have any part of their bodies in a position where they could be caught when the moon roof is being operated.
- Do not allow children to operate the moon roof.
Closing the moon roof on someone can cause death or serious injury.

■ Jam protection function

- Never try jamming any part of your body to activate the jam protection function intentionally.
- The jam protection function may not work if something gets caught just before the moon roof fully closes.

1-5. Refueling

Opening the fuel tank cap

Perform the following steps to open the fuel tank cap.

■ Before refueling the vehicle

Turn the “ENGINE START STOP” switch OFF and ensure that all the doors and windows are closed.

■ Opening the fuel tank cap



Press the fuel filler door opener switch.



Turn the fuel tank cap slowly to open.



Hang the fuel tank cap on the back of the fuel filler door.

Closing the fuel tank cap



After refueling, turn the fuel tank cap clockwise until you hear a click. The cap will revolve slightly in the opposite direction once released.

1

Before driving

■ Fuel types

Use premium unleaded gasoline. (91 Octane Rating [Research Octane Number 96] or higher)

■ Fuel tank capacity

Approximately 18.7 gal. (71 L, 15.6 Imp.gal.)

■ When the fuel filler door opener switch is inoperable



The lever can be used to open the fuel filler door if the fuel filler door cannot be opened using the inside switch because the 12 volt battery is discharged or for any other reason.

CAUTION

■ When refueling the vehicle

Observe the following precautions while refueling the vehicle. Failure to do so, may result in death or serious injury.

- Touch the vehicle or some other metal surface to discharge any static electricity. Sparks resulting from discharging static electricity may cause the fuel vapors to ignite.
- Always hold the grips on the fuel tank cap and turn it slowly to remove it. A whooshing sound may be heard when the fuel tank cap is loosened. Wait until the sound cannot be heard before fully removing the cap. In hot weather, pressurized fuel may spray out of the filler neck and cause injury.
- Do not allow anyone that has not discharged static electricity from their bodies to come close to an open fuel tank.
- Do not inhale vaporized fuel. Fuel contains substances that are harmful if inhaled.
- Do not smoke while refueling the vehicle. Doing so may cause the fuel to ignite and cause a fire.
- Do not return to the vehicle or touch any person or object that is statically charged. This may cause static electricity to build up, resulting in a possible ignition hazard.

■ When replacing the fuel tank cap

Do not use anything but a genuine Lexus fuel tank cap designed for your vehicle. Failure to do so may cause a fire or other incident which may result in death or serious injury.

NOTICE

■ Refueling

Do not spill fuel during refueling.

Failing to do so may damage the vehicle, such as causing the exhaust systems to operate abnormally or damaging fuel system components or the vehicle's painted surface.

1-6. Theft deterrent system Immobilizer system

The vehicle's keys have built-in transponder chips that prevent the engine from starting if the key has not been previously registered in the vehicle's on-board computer.

Never leave the keys inside the vehicle when you leave the vehicle.



The indicator light flashes after the "ENGINE START STOP" switch has been turned OFF to indicate that the system is operating.

1

Before driving

امداد خودرو فارما

■ System maintenance

The vehicle has a maintenance-free type of immobilizer system.

■ Conditions that may cause the system to malfunction

- If the grip portion of the key is in contact with a metallic object.
- If the key is in close proximity to or touching a key to the security system (key with a built-in transponder chip) of another vehicle.

■ Certifications for the immobilizer system

- ▶ For vehicles sold in the U.S.A.

FCC ID: NI4TMIMB-1

This device complies with Part 15 of the FCC Rules. Operation is subject to the following two conditions: (1) this device may not cause harmful interference, and (2) this device must accept any interference received, including interference that may cause undesired operation.

► For vehicles sold in Canada

Operation is subject to the following two conditions: (1) this device may not cause interference, and (2) this device must accept any interference, including interference that may cause undesired operation of the device.

CAUTION

■ Certifications for the immobilizer system

Changes or modifications not expressly approved by the party responsible for compliance could void the user's authority to operate the equipment.

NOTICE

■ For proper system operation

Do not modify, remove or disable the immobilizer system. If any unauthorized changes or modifications are made, the proper operation of the system cannot be guaranteed.

تلفن شبانه روزی: ۰۲۱ ۸۸۶۲۰۸۵

FarmaSOS.com

Alarm

The system sounds the alarm and flashes lights when forcible entry is detected.

■ Triggering of the alarm

The alarm is triggered in the following situations.

- A locked door or trunk is unlocked or opened in any way other than using the smart access system with push-button start, wireless remote control or mechanical key. (The doors will lock again automatically.)
- The hood is opened while the vehicle is locked.

■ Setting the alarm system



Close the doors, trunk and hood, and lock all doors.

The system will be set automatically after 30 seconds.

The indicator light changes from being on to flashing when the system is set.

■ Deactivating or stopping the alarm

Do one of the following to deactivate or stop the alarm.

- Unlock the doors or trunk.
- Turn the “ENGINE START STOP” switch to the ACCESSORY or IGNITION ON mode. (The alarm will be deactivated or stopped after a few seconds.)

■ Items to check before locking the vehicle

To prevent unintended triggering of the alarm and vehicle theft, make sure of the following.

- Nobody is in the vehicle.
- The windows and moon roof (if equipped) are closed before the alarm is set.
- No valuables or other personal items are left in the vehicle.

■ Triggering of the alarm

The alarm may be triggered in the following situations.
(Stopping the alarm deactivates the alarm system.)

- A person inside the vehicle opens a door, the trunk or hood.
- The 12 volt battery is recharged or replaced when the vehicle is locked.

■ When the 12 volt battery is disconnected

Be sure to cancel the alarm system.

If the 12 volt battery is disconnected before canceling the alarm, the system may be triggered when the battery is reconnected.

■ Panic mode

تلفن شبانه روزی: ۰۲۱-۸۸۶۲۰۸۵



When  is pushed for longer than about one second, the headlights/tail lights/emergency flashers will flash, the front and rear interior lights will come on, and an alarm will sound for about 60 seconds to deter any person from trying to break into or damage your vehicle.

To stop the alarm, push any button on the wireless remote control.

1-6. Theft deterrent system

Theft prevention labels (U.S.A.)

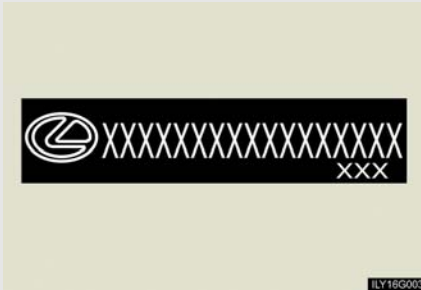

These labels are attached to the vehicle to reduce vehicle theft by facilitating the tracing and recovery of parts from stolen vehicles. Do not remove under penalty of law.

1

Before driving

امداد خودرو فارما

تلفن شبانه روزی: ۰۲۱-۸۸۸۶۲۰۸۵

FarmaSOS.com

Correct driving posture

Drive with a good posture as follows:



- 1 Sit upright and well back in the seat. (→P. 45)
- 2 Adjust the position of the seat forward or backward to ensure the pedals can be reached and easily depressed to the extent required. (→P. 45)
- 3 Adjust the seatback so that the controls are easily operable.
- 4 Adjust the tilt and telescopic positions of the steering wheel downward so the air-bag is facing your chest. (→P. 60)
- 5 Lock the head restraint in place with the center of the head restraint closest to the top of your ears. (→P. 51)
- 6 Wear the seat belt correctly. (→P. 53)

اراد خودرو فارما
تلفن: ۰۲۱-۸۸۶۲۰۸۵
FarmaSOS.com

⚠ CAUTION**■ While driving**

- Do not adjust the position of the driver's seat.
Doing so could cause the driver to lose control of the vehicle.
- Do not place a cushion between the driver or passenger and the seatback.
A cushion may prevent correct posture from being achieved, and reduce the effectiveness of the seat belt and head restraint, increasing the risk of death or serious injury to the driver or passenger.
- Do not place anything under the front seats.
Objects placed under the front seats may become jammed in the seat tracks and stop the seat from locking in place. This may lead to an accident. The adjustment mechanism may also be damaged.

■ Adjusting the seat position

- Take care when adjusting the seat position to ensure that other passengers are not injured by the moving seat.
- Do not put your hands under the seat or near the moving parts to avoid injury.
Fingers or hands may become jammed in the seat mechanism.

FarmaSOS.com

1-7. Safety information

SRS airbags

The SRS airbags inflate when the vehicle is subjected to certain types of severe impacts that may cause significant injury to the occupants. They work together with the seat belts to help reduce the risk of death or serious injury.

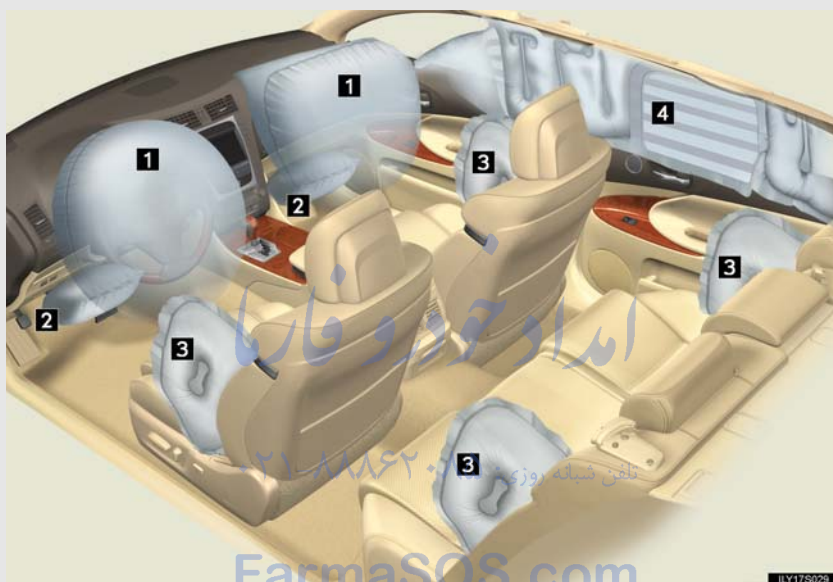

► Front airbags

1 Driver airbag/front passenger airbag

Can help protect the head and chest of the driver and front passenger from impact with interior components.

2 Knee airbag

Can help provide driver and front passenger protection.

► Side and curtain shield airbags

3 Front side airbag/rear side airbag (rear side airbags are optional)

Can help protect the torso of the front occupants and rear outboard occupants.

4 Curtain shield airbag

Can help protect primarily the head of front occupants and rear out-board occupants.

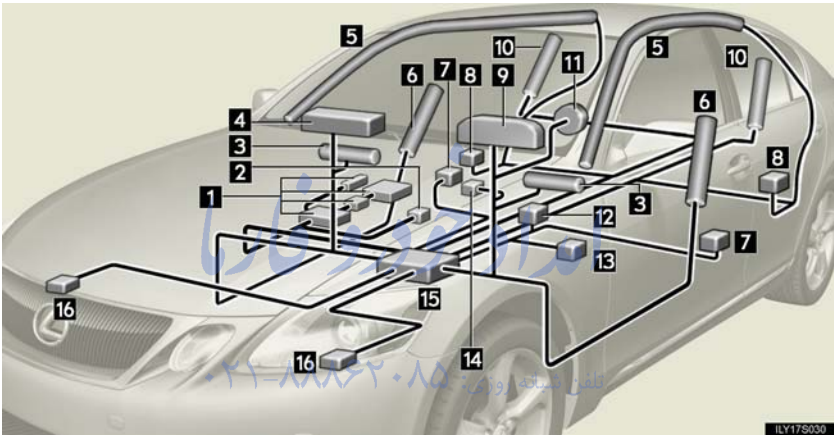
Airbag system components

- | | |
|--|---|
| 1 Occupant detection system (ECU and sensors) | 8 Curtain shield and rear side airbag sensor |
| 2 Front passenger's seat belt buckle switch | 9 SRS warning light |
| 3 Knee airbag | 10 Rear side airbag (if equipped) |
| 4 Front passenger airbag | 11 Driver airbag |
| 5 Curtain shield airbag | 12 Driver's seat belt buckle switch |
| 6 Front side airbag | 13 Driver's seat position sensor |
| 7 Side and curtain shield airbag sensor | 14 "AIR BAG ON" and "AIR BAG OFF" indicator lights |
| | 15 Airbag sensor assembly |
| | 16 Front airbag sensor |

Your vehicle is equipped with “ADVANCED AIRBAGS” designed based on US motor vehicle safety standards (FMVSS208). The airbag system controls airbag deployment power for the driver and front passenger. The driver airbag system consists of the driver’s seat position sensor etc. The front passenger’s airbag system consists of the front passenger occupant classification sensor etc.

The main SRS airbag system components are shown above. The SRS airbag system is controlled by the airbag sensor assembly. The airbag sensor assembly consists of a safing sensor and an airbag sensor.

In certain types of severe frontal or side impacts, the SRS airbag system triggers the airbag inflators. A chemical reaction in the inflators quickly fills the airbags with non-toxic gas to help restrain the motion of the occupants.

■ If the SRS airbags deploy (inflate)

- Bruising and slight abrasions may result from contact with a deploying (inflating) SRS airbag.
- A loud noise and white powder will be emitted.
- Parts of the airbag module (steering wheel hub, airbag cover and inflator) as well as the seats, and parts of the front pillar and roof side rail, may be hot for several minutes. The airbag itself may also be hot.
- The windshield may crack.

■ Operating conditions (front airbags)

- The SRS front airbags will deploy if the severity of the frontal impact is above the designed threshold level, comparable to an approximate 15 mph (25 km/h) collision when the vehicle impacts straight into a fixed barrier that does not move or deform.

However, this threshold velocity will be considerably higher if the vehicle strikes an object, such as a parked vehicle or sign pole, which can move or deform on impact, or if the vehicle is involved in an underride collision (e.g. a collision in which the front of the vehicle “underrides”, or goes under, the bed of a truck, etc.).

- It is possible that in some collisions where the forward deceleration of the vehicle is very close to the designed threshold level, the SRS front airbags and the seat belt pretensioners may not activate together.
- The SRS front passenger airbags will not activate, if there is no passenger sitting in the front passenger seat. However, the front passenger airbag may deploy, if the heavy luggage is put in the seat, even if the seat is unoccupied.

■ Operating conditions (side and curtain shield airbags)

- The SRS side airbags and curtain shield airbags are designed to inflate when the passenger compartment is subjected to a severe impact from the side.
- The SRS front side airbag on the passenger seat will not activate if there is no passenger sitting in the front passenger seat. However, the front side airbag on the passenger seat may deploy if the heavy luggage is put in the seat, even if the seat is unoccupied. (→P. 92)

■ **Conditions under which the SRS airbags may deploy (inflate), other than a collision**

The SRS front airbags may also deploy if a serious impact occurs to the underside of your vehicle. Some examples are shown in the illustration.

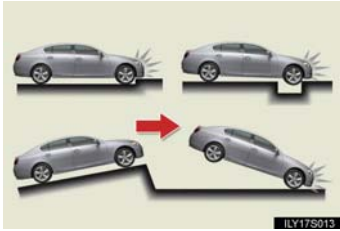

- Hitting a curb, edge of pavement or hard surface
- Falling into or jumping over a deep hole
- Landing hard or vehicle falling

■ **Types of collisions that may not deploy the SRS airbag (front airbags)**

The SRS front airbags are generally not designed to inflate if the vehicle is involved in a side or rear collision, if it rolls over, or if it is involved in a low-speed frontal collision. But, whenever a collision of any type causes sufficient forward deceleration of the vehicle, deployment of the SRS front airbags may occur.

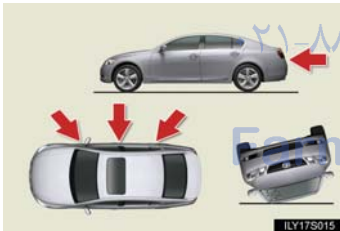

- Collision from the side
- Collision from the rear
- Vehicle rollover

■ Types of collisions that may not deploy the SRS airbag (side and curtain shield airbags)

The SRS side airbag and curtain shield airbag system may not activate if the vehicle is subjected to a collision from the side at certain angles, or a collision to the side of the vehicle body other than the passenger compartment.

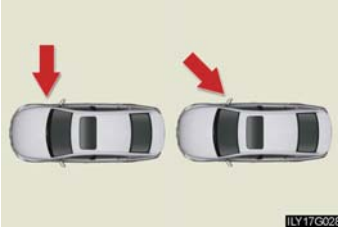

- Collision from the side to the vehicle body other than the passenger compartment
- Collision from the side at an angle

The SRS side airbags and curtain shield airbags are generally not designed to inflate if the vehicle is involved in a frontal or rear collision, if it rolls over, or if it is involved in a low-speed side collision.



- Collision from the front
- Collision from the rear
- Vehicle rollover

■ When to contact your Lexus dealer

In the following cases, contact your Lexus dealer as soon as possible. Do not disconnect the 12 volt battery cables before contacting your Lexus dealer.

- Any of the SRS airbags have been inflated.

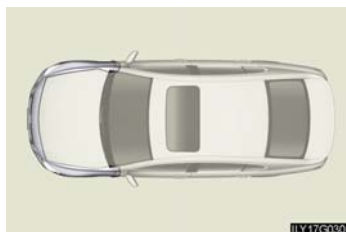

- The front of the vehicle is damaged or deformed, or was involved in an accident that was not severe enough to cause the SRS airbags to inflate.

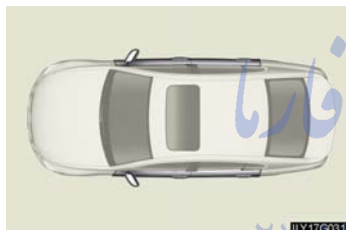

- A portion of the doors is damaged or deformed, or the vehicle was involved in an accident that was not severe enough to cause the SRS side airbags and curtain shield airbags to inflate.



- The pad section of the steering wheel, front passenger airbag cover or lower portion of the instrument panel is scratched, cracked, or otherwise damaged.



- The surface of the seats with the side airbag is scratched, cracked, or otherwise damaged.
- The portion of the front pillars, rear pillars or roof side rail garnishes (padding) containing the curtain shield airbags inside is scratched, cracked, or otherwise damaged.

 **CAUTION**
■ SRS airbag precautions

Observe the following precautions regarding the airbags. Failure to do so may cause death or serious injury.

- The driver and all passengers in the vehicle must wear their seat belts properly. The SRS airbags are supplemental devices to be used with the seat belts.
- The SRS driver airbag deploys with considerable force, and can cause death or serious injury especially if the driver is very close to the airbag. The National Highway Traffic Safety Administration (“NHTSA”) advises:

Since the risk zone for driver airbag is the first 2 - 3 in. (50 - 75 mm) of inflation, placing yourself 10 in. (250 mm) from your driver airbag provides you with a clear margin of safety. This distance is measured from the center of the steering wheel to your breastbone. If you sit less than 10 in. (250 mm) away now, you can change your driving position in several ways:

- Move your seat to the rear as far as you can while still reaching the pedals comfortably.
- Slightly recline the back of the seat. Although vehicle designs vary, many drivers can achieve the 10 in. (250 mm) distance, even with the driver seat all the way forward, simply by reclining the back of the seat somewhat. If reclining the back of your seat makes it hard to see the road, raise yourself by using a firm, non-slippery cushion, or raise the seat if your vehicle has that feature.
- If your steering wheel is adjustable, tilt it downward. This points the airbag toward your chest instead of your head and neck.

The seat should be adjusted as recommended by NHTSA above, while still maintaining control of the foot pedals, steering wheel, and your view of the instrument panel controls.

CAUTION

SRS airbag precautions



- If the seat belt extender has been connected to the driver's seat belt buckle but the seat belt extender has not also been fastened to the latch plate of the driver's seat belt, the SRS driver's airbag system will judge that the driver is wearing the seat belt even though the seat belt has not been connected. In this case, the driver's airbag may not activate correctly in a collision, resulting in death or serious injury in the event of collision. Be sure to wear the seat belt with the seat belt extender.
- The SRS front passenger airbag also deploys with considerable force, and can cause death or serious injury especially if the front passenger is very close to the airbag. The front passenger seat should be as far from the airbag as possible with the seatback adjusted, so the front passenger sits upright.
- Improperly seated and/or restrained infants and children can be killed or seriously injured by a deploying airbag. An infant or child who is too small to use a seat belt should be properly secured using a child restraint system. Lexus strongly recommends that all infants and children be placed in the rear seats of the vehicle and properly restrained. The rear seats are the safest for infants and children. (→P. 98)

 CAUTION

■ SRS airbag precautions

- Do not sit on the edge of the seat or lean against the dashboard.

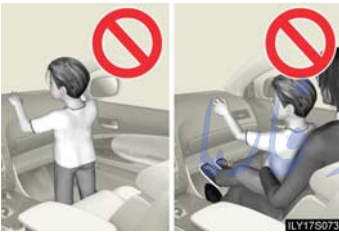

- Do not allow a child to stand in front of the SRS front passenger airbag unit or sit on the knees of a front passenger.
- Do not drive the vehicle while the driver or passenger have items resting on their knees.



- Do not lean against the door, the roof side rail or the front, side and rear pillars.



- Do not allow anyone to kneel on the passenger seat toward the door or put their head or hands outside the vehicle.

CAUTION

SRS airbag precautions



● Do not attach anything to or lean anything against areas such as the dashboard, steering wheel pad or lower portion of the instrument panel. These items can become projectiles when SRS driver, front passenger and knee airbags deploy.



● Do not attach anything to areas such as the door, windshield glass, side door glass, front and rear pillars, roof side rail or assist grip.

● Do not hang coat hangers or other hard objects on the coat hooks. All of these items could become projectiles and seriously injure or kill you, should the SRS curtain shield airbag deploy.

- If the vinyl cover is put on the area where the SRS knee airbag will deploy, be sure to remove it.
- Do not use seat accessories which cover the parts where the SRS side airbags inflate as they may interfere with inflation of the airbags.
- Do not strike or apply significant levels of force to the area of the SRS airbag components shown on P. 81. Doing so can cause the SRS airbags to malfunction.
- Do not touch any of the component parts immediately after the SRS airbags have deployed (inflated) as they may be hot.

 **CAUTION**
■ SRS airbag precautions

- If breathing becomes difficult after the SRS airbag has deployed, open a door or window to allow fresh air in, or leave the vehicle if it is safe to do so. Wash off any residue as soon as possible to prevent skin irritation.
- If the areas where the SRS airbags are stored, such as the steering wheel pad and front pillar garnish, are damaged or cracked, have them replaced by your Lexus dealer.
- Do not place anything, such as a cushion, on the front passenger's seat. Doing so will disperse the passenger's weight, which prevents the sensor from detecting the passenger's weight properly. As a result, the SRS front passenger airbag may not deploy in the event of a collision.

■ Modification and disposal of SRS airbag system components

Do not dispose of your vehicle or perform any of the following modifications without consulting your Lexus dealer. The SRS airbags may malfunction or deploy (inflate) accidentally, causing death or serious injury.

- Installation, removal, disassembly and repair of the SRS airbags
- Repairs, modifications, removal or replacement of the steering wheel, instrument panel, dashboard, seats or seat upholstery, front, side and rear pillars or roof side rail
- Repairs or modifications of the front fender, front bumper, or side of the occupant compartment
- Installation of snow plows, winches, etc. to the front grille (bull bars, kangaroo bar etc.)
- Modifications to the vehicle's suspension system
- Installation of electronic devices such as mobile two-way radios or CD players
- Modifications to your vehicle for a person with a physical disability

1-7. Safety information

Front passenger occupant classification system

Your vehicle is equipped with a front passenger occupant classification system. This system detects the conditions of the front passenger seat and activates or deactivates the devices for front passenger.



1 SRS warning light

2 "AIR BAG OFF" indicator light

3 "AIR BAG ON" indicator light

4 Front passenger's seat belt reminder light

Condition and operation in the front passenger occupant classification system

■ Adult*1

Indicator/ warning light	"AIR BAG ON" and "AIR BAG OFF" indicator lights	"AIR BAG ON"
	SRS warning light	Off
	Front passenger's seat belt reminder light	Flashing*2
Devices	Front passenger airbag and knee airbag	Activated
	Side airbag in the front passenger seat	
	Curtain shield airbag on the front passenger side	
	Front passenger's seat belt pretensioner	

■ Child*3 or child restraint system*4

Indicator/ warning light	"AIR BAG ON" and "AIR BAG OFF" indicator lights	"AIR BAG OFF"*5
	SRS warning light	Off
	Front passenger's seat belt reminder light	Flashing*2
Devices	Front passenger airbag and knee airbag	Deactivated
	Side airbag in the front passenger seat	
	Curtain shield airbag on the front passenger side	Activated
	Front passenger's seat belt pretensioner	

1

Before driving

■ Unoccupied

Indicator/ warning light	"AIR BAG ON" and "AIR BAG OFF" indicator lights	Not illuminated
	SRS warning light	Off
	Front passenger's seat belt reminder light	
Devices	Front passenger airbag and knee airbag	Deactivated
	Side airbag in the front passenger seat	
	Curtain shield airbag on the front passenger side	Activated
	Front passenger's seat belt pretensioner	Deactivated

■ System malfunction

Indicator/ warning light	"AIR BAG ON" and "AIR BAG OFF" indicator lights	"AIR BAG OFF"
	SRS warning light	On
	Front passenger's seat belt reminder light	Off
Devices	Front passenger airbag and knee airbag	Deactivated
	Side airbag in the front passenger seat	
	Curtain shield airbag on the front passenger side	Activated
	Front passenger's seat belt pretensioner	

- *1: The system judges a person of adult size as an adult. When a smaller adult sits in the front passenger seat, the system may recognize him/her as a child depending on his/her physique and posture.
- *2: In the event the front passenger does not wear a seat belt.
- *3: When a large child who has outgrown a child restraint system sits in the front passenger seat, the system may recognize him/her as an adult depending on his/her physique and posture.
- *4: Never install a rear-facing child restraint system on the front passenger seat. A forward-facing child restraint system should only be installed on the front passenger seat when it is unavoidable. (→P. 98)
- *5: In case the indicator is not illuminated, consult this manual as for installing the child restraint system properly. (→P. 102)

CAUTION

■ Front passenger occupant classification system precautions

Observe the following precautions regarding the front passenger occupant classification system.

Failure to do so may cause death or serious injury.

- Wear the seat belt properly.
- Make sure the front passenger's seat belt tab has not been left inserted into the buckle before someone sits in the front passenger seat.

 CAUTION

■ Front passenger occupant classification system precautions

- Make sure the “AIR BAG OFF” indicator light is not illuminated when using the seat belt extender for the front passenger seat. If the “AIR BAG OFF” indicator light is illuminated, disconnect the extender tongue from the seat belt buckle, then reconnect the seat belt. Reconnect the seat belt extender after making sure the “AIR BAG ON” indicator light is illuminated. If you use the seat belt extender while the “AIR BAG OFF” indicator light is illuminated, the front passenger airbag, side airbag on the front passenger side and front passenger knee airbag may not activate correctly, which could cause death or serious injury in the event of a collision.
- Do not apply a heavy load to the front passenger seat or equipment.
- Do not put weight on the front passenger seat by putting your hands or feet on the front passenger seat seatback from the rear seat.
- Do not let a rear seat passenger lift the front passenger seat with their feet or press on the seatback with their legs.
- Do not put objects under the front passenger seat.
- Do not recline the front passenger seatback so far that it touches a rear seat. This may cause the “AIR BAG OFF” indicator light to be illuminated, which indicates that the passenger’s airbags will not deploy in the event of a severe accident. If the seatback touches the rear seat, return the seatback to a position where it does not touch the rear seat. Keep the front passenger seatback as upright as possible when the vehicle is moving. Reclining the seatback excessively may lessen the effectiveness of the seat belt system.

 CAUTION**■ Front passenger occupant classification system precautions**

- If an adult sits in the front passenger seat, the "AIR BAG ON" indicator light is illuminated. If the "AIR BAG OFF" indicator is illuminated, ask the passenger to sit up straight, well back in the seat, feet on the floor, and with the seat belt worn correctly. If the "AIR BAG OFF" indicator still remain illuminated, either ask the passenger to move to the rear seat, or if that is not possible, move the front passenger seat fully rearward.
- When it is unavoidable to install a forward-facing child restraint system on the front passenger seat, install the child restraint system on the front passenger seat in the proper order. (→P. 102)
- Do not modify or remove the front seat.
- Do not kick the front passenger seat or subject it to severe impact. Otherwise, the SRS warning light may come on to indicate a malfunction in the detection system. In this case, contact your Lexus dealer immediately.
- Do not use a seat accessory, such as a cushion or seat cover, that covers the seat cushion surface.
- Child restraint systems installed on the rear seat should not contact the front seat-backs.

1-7. Safety information

Child restraint systems

A child restraint system for a small child or baby must itself be properly restrained on the seat with the lap portion of the lap/shoulder belt.

The laws of all 50 states of the U.S.A. and Canada now require the use of child restraint systems.

Points to remember

Studies have shown that installing a child restraint on a rear seat is much safer than installing one to the front passenger seat.

- Choose a child restraint system appropriate to the age and size of the child.
- For installation details, follow the instructions provided with the child restraint system.
General installation instructions are provided in this manual. (→P.102)

Types of child restraints

Child restraint systems are classified into the following 3 types according to the age and size of the child.

► Infant seat



► Convertible seat



► Booster seat

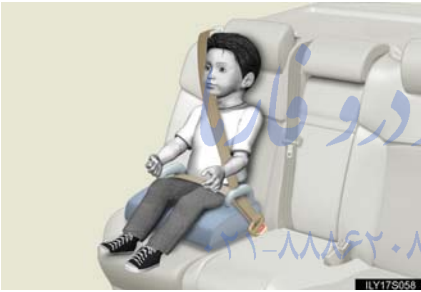

FarmaSOS.com

■ Selecting an appropriate child restraint system

Get an appropriate child restraint system for the child. If a child is too large for a child restraint system, sit the child on a rear seat and use the vehicle's seat belt. (→P.53)

 CAUTION

■ Child restraint precautions

- For effective protection in automobile accidents and sudden stops, a child must be properly restrained, using a seat belt or child restraint system depending on the age and size of the child. Holding a child in your arms is not a substitute for a child restraint system. In an accident, the child can be crushed against the windshield, or between you and the vehicle's interior.
- Lexus strongly urges the use of a proper child restraint system that conforms to the size of the child, installed on the rear seat. According to accident statistics, the child is safer when properly restrained in the rear seat than in the front seat.
- Never install a rear-facing child restraint system on the front passenger seat even if the "AIR BAG OFF" indicator light is illuminated. In the event of an accident, the force of the rapid inflation of the front passenger airbag can cause death or serious injury to the child if the rear-facing child restraint system is installed on the front passenger seat.
- A forward-facing child restraint system should allowed to be installed on the front passenger seat only when it is unavoidable. Always move the seat as far back as possible even if the "AIR BAG OFF" indicator light is illuminated, because the front passenger airbag could inflate with considerable speed and force. Otherwise, the child may be killed or seriously injured.
- Do not use the seat belt extender when installing a child restraint system on the front or rear passenger seat. If installing a child restraint system with the seat belt extender connected to the seat belt, the seat belt will not securely hold the child restraint system, which could cause death or serious injury to the child or other passengers in the event of collision.

! CAUTION**■ Child restraint precautions**

- Do not allow the child to lean his/her head or any part of his/her body against the door or the area of the seat, front pillar or roof side rail from which the side airbags or curtain shield airbags deploy even if the child is seated in the child restraint system. It is dangerous if the side airbags and curtain shield airbags inflate, and the impact could cause death or serious injury to the child.
- Make sure you have complied with all installation instructions provided by the child restraint manufacturer and that the system is properly secured. If it is not secured properly, it may cause death or serious injury to the child in the event of a sudden stop or accident.

■ When the child restraint system is not in use

- Keep the child restraint system properly secured on the seat even if it is not in use. Do not store the restraint unsecured in the passenger compartment.
- If it is necessary to detach the child restraint system, remove it from the vehicle or store it securely in the trunk. This will prevent it from injuring passengers in the event of a sudden stop or accident.

تلفن شماره روزی: ۰۲۱-۸۸۶۲۰۸۵

FarmaSOS.com

1-7. Safety information

Installing child restraints

Follow the child restraint system manufacturer's instructions. Firmly secure child restraints to the outboard rear seats using a seat belt or a child restraint lower anchors belt. Attach the top strap when installing a child restraint.

1



1 Seat belts equipped with a child restraint locking mechanism (ALR/ELR belts except driver's seat belt)

2



2 Child restraint lower anchors
Lower anchors are provided for the outboard rear seats. (Buttons displaying the location of the anchors are attached to the seats.)

3



3 Anchor bracket
(for top strap)

Anchor brackets are provided for all rear seats.

Installing child restraints using a seat belt (child restraint lock function belt)

■ Rear-facing — Infant seat/convertible seat

STEP 1

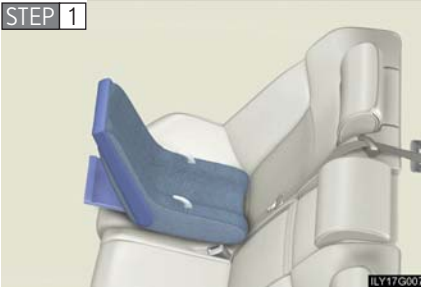

Place the child restraint system on the rear seat facing the rear of the vehicle.

STEP 2

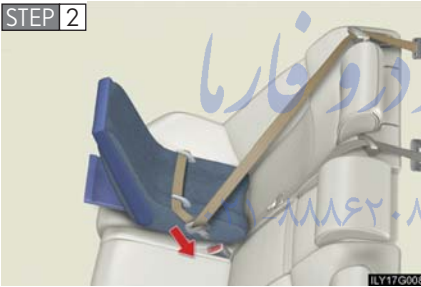

Run the seat belt through the child restraint system and insert the plate into the buckle. Make sure that the belt is not twisted.

STEP 3



Fully extend the shoulder belt and then allow it to retract slightly in order to activate the ALR lock mode.

Lock mode allows the seat belt to retract only.

1

Before driving

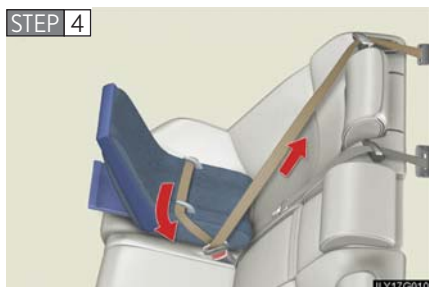

While pushing the child restraint system down into the rear seat, allow the shoulder belt to retract until the child restraint system is securely in place.

After the shoulder belt has retracted to a point where there is no slack in the belt, pull the belt to check that it cannot be extended.

■ Forward-facing — Convertible seat



Place the child restraint system on the seat facing the front of the vehicle.



Run the seat belt through the child restraint system and insert the plate into the buckle. Make sure that the belt is not twisted.



Fully extend the shoulder strap and then allow it to retract slightly into the ALR lock mode.

Lock mode allows the seat belt to retract only.



While pushing the child restraint system into the rear seat, allow the shoulder belt to retract until the child restraint system is securely in place.

After the shoulder belt has retracted to a point where there is no slack in the belt, pull the belt to check that it cannot be extended.

■ Booster seat



Place the child restraint system on the seat facing the front of the vehicle.



Sit the child in the child restraint system. Fit the seat belt to the child restraint system according to the manufacturer's instructions and insert the plate into the buckle. Make sure that the belt is not twisted.

Check that the shoulder belt is correctly positioned over the child's shoulder, and that the lap belt is as low as possible. (→P. 53)

امداد خودرو فارس
تلفن شبانه روزی: ۰۵۲۰۸۸۴۶-۲۱

maSOS.com

Removing a child restraint installed with a seat belt

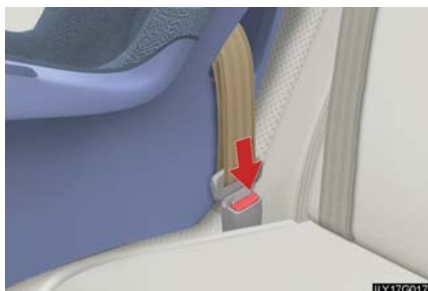

Push the buckle release button and fully retract the seat belt.

Installation with child restraint lower anchors

► Type A

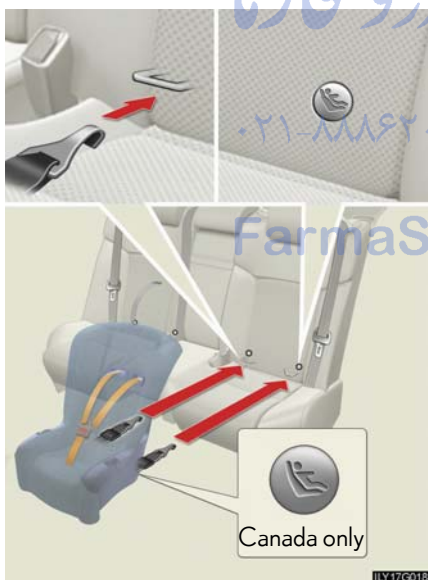

STEP 1 Widen the gap between the seat cushion and seat-back slightly.

STEP 2 Latch the hooks of the lower straps onto the anchors.

If the child restraint has a top strap, the top strap should be latched onto the anchors.

For owners in Canada:
The symbol on a child restraint system indicates the presence of a lower connector system.

► Type B

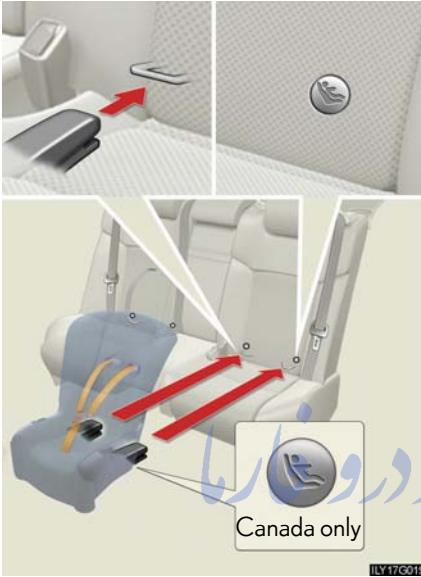

STEP 1 Widen the gap between the seat cushion and seatback slightly.

STEP 2 Latch the buckles onto the anchors.

If the child restraint has a top strap, the top strap should be latched onto the anchors.

For owners in Canada:
The symbol on a child restraint system indicates the presence of a lower connector system.

1

Before driving

Child restraint systems with a top strap



STEP 1

Secure the child restraint system using a seat belt or lower anchors, and move the head restraint in place at the lowest position.

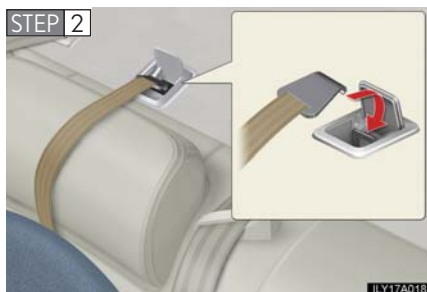

Open the anchor bracket cover, latch the hook onto the anchor bracket and tighten the top strap.

Make sure the top strap is securely latched.

■ Laws and regulations pertaining to anchorages

Anchorage conform to FMVSS225 or CMVSS210.2.

Child restraint systems conforming to FMVSS213 or CMVSS213 specifications can be used.

This vehicle is designed to conform to the SAE J1819.

⚠ CAUTION

■ When installing a booster seat

Do not fully extend the shoulder belt to prevent the belt from going to ALR lock mode: (→P. 55)

- ALR mode causes the belt to tighten only which could cause injury or discomfort to the child.
- Do not allow the child to play with the seat belt or the child could be killed or seriously injured.

⚠ CAUTION

■ When installing a child restraint system

Follow the directions given in the child restraint system installation manual and fix the child restraint system securely in place.

If the child restraint system is not correctly fixed in place, the child or other passengers may be injured or even killed in the event of sudden braking or an accident.



- If the driver's seat interferes with the child restraint system and prevents it from being attached correctly, attach the child restraint system to the right-hand rear seat.



- Only put a forward-facing child restraint system on the front seat when unavoidable. When installing a forward-facing child restraint on the front passenger seat, move the seat as far back as possible even if the "AIR BAG OFF" indicator light is illuminated. Failing to do so may result in death or serious injury if the airbags deploy (inflate).

- When a booster seat is installed, always ensure that the shoulder belt is positioned across the center of the child's shoulder. The belt should be kept away from the child's neck, but not so that it could fall off the child's shoulder. Failing to do so may result in death or serious injury in the event of an accident or sudden braking.

 **CAUTION**

■ **When installing a child restraint system**

- Ensure the belt and tab are securely locked and that the seat belt is not twisted.
- Push and pull the child restraint system in different directions to be sure it is secure.
- Follow all installation instructions provided by the child restraint system manufacturer.

■ **Do not use a seat belt extender**

If a seat belt extender is used when installing a child restraint system, the seat belt will not securely hold the child restraint system, which could cause death or serious injury to the child or other passengers in the event of a collision.

■ **To correctly attach a child restraint system to the anchors**

When using the lower anchors, be sure that there are no foreign objects around the anchors and that the seat belt is not caught behind the child restraint system. Make sure the child restraint system is securely attached, or it may cause death or serious injury to the child or other passengers in the event of a sudden stop or accident.

تلفن شبانه روزی: ۰۲۱-۸۸۶۲۰۸۵

FarmaSOS.com

2-1. Driving procedures	112	2-3. Operating the lights and windshield wipers	142
Driving the vehicle.....	112	Headlight switch	142
Engine (ignition) switch.....	121	Fog light switch	145
Automatic transmission	125	Windshield wipers and washer	146
Turn signal lever	130	Headlight cleaner switch	149
Parking brake	131		
2-2. Instrument cluster	132	2-4. Using other driving systems	150
Gauges and meters.....	132	Cruise control.....	150
Indicators and warning lights	136	Dynamic radar cruise control	153
Multi-information display	139	Intuitive parking assist.....	164
		Rear view monitor system.....	179
		AVS (Adaptive Variable Suspension System)	183
		Driving assist systems	184
		PCS (Pre-Collision System)	190
		2-5. Driving information.....	194
		Cargo and luggage	194
		Vehicle load limits.....	198
		Winter driving tips	199
		Trailer towing	204
		Dinghy towing.....	205

2-1. Driving procedures

Driving the vehicle

The following procedures should be observed to ensure safe driving.

■ Starting the engine (→P. 121)

■ Driving

STEP 1 With the brake pedal depressed, shift the shift lever to “D”.
(→P. 125)

STEP 2 Release the parking brake. (→P. 131)

STEP 3 Gradually release the brake pedal and gently push the accelerator pedal to accelerate the vehicle.

■ Stopping

STEP 1 With the shift lever in “D”, push the brake pedal.

STEP 2 If necessary, set the parking brake.

When the vehicle is stopped for an extended period of time, shift the shift lever to “P”.
(→P.125)

■ Parking the vehicle

STEP 1 With the shift lever in “D”, push the brake pedal.

STEP 2 Set the parking brake. (→P.131)

STEP 3 Shift the shift lever to “P”. (→P.125)

STEP 4 Stop the engine.

STEP 5 Lock the door, making sure that you have the electronic key on your person.

Starting on a steep incline

STEP 1 Firmly set the parking brake and shift the shift lever to “D”.

STEP 2 Gently depress the accelerator pedal.

STEP 3 Release the parking brake.

■ Driving in the rain

- Drive carefully when it is raining, because visibility will be reduced, the windows may become fogged-up, and the road will be slippery.
- Drive carefully when it starts to rain, because the road surface will be especially slippery.
- Refrain from high speeds when driving on an expressway in the rain, because there may be a layer of water between the tires and the road surface, preventing the steering and brakes from operating properly.

■ Breaking in your new Lexus

To extend the life of the vehicle, the following precautions are recommended to observe:

- For the first 186 miles (300 km):
Avoid sudden stops.
- For the first 621 miles (1000 km):
 - Do not drive at extremely high speeds.
 - Avoid sudden acceleration.
 - Do not drive continuously in the low range in the “S” position.
 - Do not drive at a constant speed for extended periods.

■ Operating your vehicle in a foreign country

Comply with the relevant vehicle registration laws and confirm the availability of the correct fuel. (→P. 543)

■ When starting on an incline

The hill-start assist control may operate. (→P. 184)

CAUTION

■ When starting the vehicle

Always keep your foot on the brake pedal while stopped with the engine running. This prevents the vehicle from creeping.

■ When driving the vehicle

- Do not drive if you are unfamiliar with the location of the brake and accelerator pedals to avoid depressing the wrong pedal.
 - Accidentally depressing the accelerator pedal instead of the brake pedal will result in sudden acceleration that may lead to an accident that could result in death or serious injury.
 - When backing up, you may twist your body around, leading to a difficulty in operating the pedals. Make sure to operate the pedals properly.
 - Make sure to keep a correct driving posture even when moving the vehicle only slightly, allowing you to depress the brake and accelerator pedals properly.
 - Depress the brake pedal using your right foot. Depressing the brake pedal using your left foot may delay response in an emergency, resulting in an accident.
- Do not drive the vehicle over or stop the vehicle near flammable materials. The exhaust system and exhaust gases can be extremely hot. This may cause a fire if there is any flammable material nearby.
- Do not let the vehicle roll backwards while the shift lever is in a driving position, or roll forward while the shift lever is in "R".
Doing so may cause the engine not to operate or lead to poor brake and steering performance, resulting in an accident or damage to the vehicle.
- If the smell of exhaust is noticed inside the vehicle, open the windows and check that the trunk is closed.
Large amounts of exhaust in the vehicle can cause driver drowsiness and an accident, resulting in death or a serious health hazard. Have the vehicle inspected by your Lexus dealer immediately.
- Do not under any circumstances shift the shift lever to "P", "R" or "N" while the vehicle is moving.
Doing so can cause significant damage to the automatic transmission and may result in a loss of vehicle control.

 **CAUTION**
■ When driving the vehicle

- Do not shift the shift lever to “N” while the vehicle is moving.
Doing so may cause the engine brake not to operate properly and lead to an accident.
- Do not turn the engine off while driving.
The power steering and brake actuator (GS460) or brake booster (GS350) will not operate properly if the engine is off.
- Use engine braking (downshift) to maintain a safe speed when driving down a steep hill.
Using the brakes continuously may cause the brakes to overheat and lose effectiveness. (→P. 127)
- When stopped on an inclined surface, use the brake pedal and parking brake to prevent the vehicle from rolling backward or forward and causing an accident.
- Be careful when driving on slippery surfaces, as the vehicle may spin or skid when downshifting, rapidly accelerating, braking or turning.
- Do not adjust the position of the steering wheel, the seat, or the inside or outside rear view mirrors while driving.
Doing so may result in a loss of vehicle control that can cause accidents that may result in death or serious injury.
- Always check that all passengers' arms, heads or other parts of their bodies are not outside the vehicle, as this may result in death or serious injury.
- Do not drive in excess of the speed limit. Even if the legal speed limit permits it, do not drive over 85 mph (140 km/h) unless your vehicle has high-speed capability tires. Driving over 85 mph (140 km/h) may result in tire failure, loss of control and possible injury. Be sure to consult a tire dealer to determine whether the tires on your vehicle are high-speed capability tires or not before driving at such speeds.

CAUTION

■ When driving on slippery road surfaces

- Sudden braking, acceleration and steering may cause tire slippage and reduce your ability to control the vehicle, resulting in an accident.
- Sudden changes in engine speed, such as engine braking caused by up-shifting or down-shifting, may cause the vehicle to skid, resulting in an accident.
- After driving through a puddle, lightly depress the brake pedal to make sure that the brakes are functioning properly. Wet brake pads may prevent the brakes from functioning properly. If the brakes on only one side are wet and not functioning properly, steering control may be affected, resulting in an accident.

■ When shifting the shift lever

Be careful not to shift the shift lever with the accelerator pedal depressed. This may lead to unexpected rapid acceleration of the vehicle that may cause an accident and result in death or serious injury.

■ When the vehicle is stopped

- Do not race the engine.
If the vehicle is in any positions other than "P" or "N" the vehicle may accelerate suddenly and unexpectedly, and may cause an accident.
- Do not leave the vehicle with the engine on for a long time.
If such a situation cannot be avoided, park the vehicle in an open space and check that exhaust fumes do not enter the vehicle interior.
- Always keep a foot on the brake pedal while the engine is running to prevent an accident caused by the vehicle moving.

 **CAUTION**
■ When the vehicle is parked

- Do not leave glasses, cigarette lighters, spray cans, or soft drink cans in the vehicle when it is in the sun.

Failure to do so may result in the following:

- Gas may leak from a cigarette lighter or spray can, and may lead to a fire.
 - The temperature inside the vehicle may cause the plastic lenses and plastic material of eye glasses to deform or crack.
 - Soft drink cans may fracture, causing the contents to spray over the interior of the vehicle, and may also cause a short circuit in the vehicle's electrical components.
- Always apply the parking brake, shift the shift lever to "P", stop the engine and lock the vehicle.
Do not leave the vehicle unattended while the engine is running.
 - Do not touch the exhaust pipe while the engine is running or immediately after turning the engine off.
Doing so may cause burns.
 - Do not leave the engine running in an area with snow build-up, or where it is snowing. If snowbanks build up around the vehicle while the engine is running, exhaust gases may collect and enter the vehicle. This may lead to death or a serious health hazard.

■ Exhaust gases

Exhaust gases include harmful carbon monoxide (CO) that is colorless and odorless. Inhaling exhaust gases may lead to death or a serious health hazard.

- If the vehicle is in a poorly ventilated area, stop the engine. In a closed area, such as a garage, exhaust gases may collect and enter the vehicle. This may lead to death or a serious health hazard.
- The exhaust should be checked occasionally. If there is a hole or crack caused by corrosion, damage to a joint or abnormal exhaust noise, be sure to have the vehicle inspected and repaired by your Lexus dealer. Failure to do so may allow exhaust gases to enter the vehicle, resulting in death or a serious health hazard.

CAUTION

■ When taking a nap in the vehicle

Always turn the engine off. Otherwise, you may accidentally move the shift lever or depress the accelerator pedal, which could cause an accident or fire due to engine overheating. Additionally, if the vehicle is parked in a poorly ventilated area, exhaust gases may collect and enter the vehicle, leading to death or a serious health hazard.

■ When braking the vehicle

- When the brakes are wet, drive more cautiously.

Braking distance increases when the brakes are wet, and may cause one side of the vehicle to brake differently than the other side. Also the parking brake may not securely hold the vehicle.

- If the brake actuator (GS460) or brake booster (GS350) does not operate, do not follow other vehicles closely and avoid downhill or sharp turns that require making.

In this case, braking is still possible, but it will require more force on the pedal than usual. Braking distance may also increase.

- Do not pump the brake pedal if turning the engine off.

Each push on the brake pedal uses up the reserve for the power-assisted brakes.

- The brake system consists of 3 (GS460) or 2 (GS350) individual hydraulic systems: If one of the systems fails, the other will still operate. In this case, the brake pedal should be depressed more firmly than usual and braking distance becomes longer.

Do not drive your vehicle with only a single brake system. Have your brakes fixed immediately.

■ If the vehicle becomes stuck or bogged (4WD models)

Do not spin the wheels recklessly when any of the tires is up in the air, or stuck in sand or mud, etc. This may damage the drive system components or propel the vehicle forward (or in another direction) and cause an accident.

 NOTICE

■ **While driving the vehicle**

Do not use the accelerator pedal or depress accelerator and brake pedals together to hold the vehicle on a hill.

■ **When parking the vehicle**

Always put the shift lever in "P". Failure to do so may cause the vehicle to move or the vehicle may accelerate suddenly if the accelerator pedal is accidentally depressed.

■ **Avoiding damage to vehicle parts**

- Do not turn the steering wheel fully in either direction and hold it there for a long time.
Doing so may damage the power steering motor.
- When driving over bumps in the road, drive as slowly as possible to avoid damaging the wheels, underside of the vehicle, etc.

■ **If you hear a squealing or scraping noise (brake pad wear limit indicators)**

Have your Lexus dealer check and replace the brake pads as soon as possible. The rotor damage can result if the pads are not replaced when needed.

Front brake only: Moderate levels of the brake pad and disc wear allow enhanced front braking power. As a result, the discs may wear more quickly than conventional brake discs. Therefore, when replacing the brake pads, Lexus recommends that you also have the thickness of the discs measured.

It is dangerous to drive the vehicle when the wear limits of the brake pads and/or that of the brake discs are exceeded.

NOTICE

■ If you get a flat tire while driving

A flat or damaged tire may cause the following situations. Hold the steering wheel firmly and gradually press the brake pedal to slow down the vehicle.

- It may be difficult to control your vehicle.
- The vehicle will make abnormal sounds.
- The vehicle will behave abnormally.

Replace a flat tire with a new one. (→P. 515)

■ When encountering flooded roads

Do not drive on a road that has flooded after heavy rain etc. Doing so may cause the following serious damage to the vehicle.

- Engine stalling
- Short in electrical components
- Engine damage caused by water immersion

In the event that you drive on a flooded road and the vehicle is flooded, be sure to have your Lexus dealer check the following. تلفن شبانه روزی: ۰۲۱-۸۸۸۸۸۸۸۸

- Brake function
- Changes in quantity and quality of oil and fluid used for the engine, automatic transmission, transfer (4WD models), differentials, etc.
- Lubricant condition for the propeller shaft (4WD models), bearings and suspension joints (where possible) and the function of all joints, bearings, etc.

2-1. Driving procedures

Engine (ignition) switch

■ Starting the engine

STEP 1 Check that the parking brake is set.

STEP 2 Check that the shift lever is set in "P".

STEP 3 Sit in the driver's seat and firmly depress the brake pedal.

The "ENGINE START STOP" switch indicator turns green.

STEP 4



Press the "ENGINE START STOP" switch.

2

When driving

تلفن شبانه روزی: ۰۲۱-۸۸۶۲۰۸۵

FarmaSOS.com

■ Changing “ENGINE START STOP” switch mode

Modes can be switched by pressing the “ENGINE START STOP” switch when carrying the electronic key on your person. (The engine can be started in any mode by operating the switch at the same time as depressing the brake pedal.)

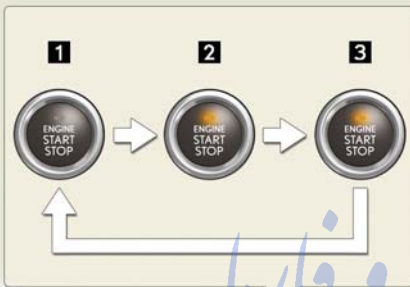

1 OFF*

Emergency flashers can be used.

2 ACCESSORY mode

Some electrical components such as the audio system can be used.

The “ENGINE START STOP” switch indicator turns amber.

3 IGNITION ON mode

All electrical components can be used.

The “ENGINE START STOP” switch indicator turns green.

*: The power cannot be switched to OFF unless the shift lever is in “P”.

■ **If the engine does not start**

The immobilizer system may not have been deactivated. (→P. 73)

■ **When the steering lock cannot be released**



The green indicator light on the “ENGINE START STOP” switch will flash and a message will be shown on the multi-information display. Press the “ENGINE START STOP” switch again while turning the steering wheel left and right.

■ **When the “ENGINE START STOP” switch indicator flashes in amber**

The system may be malfunctioning. Have the vehicle inspected by your Lexus dealer immediately.

■ **Auto power OFF function**

If the vehicle is left in the ACCESSORY mode for more than an hour with the shift lever in “P”, the “ENGINE START STOP” switch will automatically turn OFF.

■ **Electronic key battery depletion**

→P. 28

■ **When the electronic key battery is discharged**

→P. 440

■ **Conditions affecting operation**

→P. 26

■ **Leak detection pump**

Several hours after the engine is turned off, you may hear a sound coming from underneath the luggage compartment for several minutes. This is normal operation and does not indicate a malfunction.

CAUTION

■ When starting the engine

Always start the engine while sitting in the driver's seat. Do not press the accelerator pedal while starting the engine under any circumstances.

Doing so may cause an accident resulting in death or serious injury.

■ Stopping the engine in an emergency

If you want to stop the engine in an emergency while driving the vehicle, push and hold the "ENGINE START STOP" switch for more than 3 seconds.

However, do not touch the "ENGINE START STOP" switch while driving except in an emergency. If the engine stops while the vehicle is being driven, this could lead to an unexpected accident.

NOTICE

■ To prevent 12 volt battery discharge

Do not leave the "ENGINE START STOP" switch in ACCESSORY or IGNITION ON mode for long periods if the engine is not running.

■ When starting the engine

● Do not race the engine.

● If the engine becomes difficult to start or stalls frequently, have the engine checked immediately.

2-1. Driving procedures

Automatic transmission

Select a shift position appropriate for the driving conditions.

■ Shifting the shift lever



← While the “ENGINE START STOP” switch is in IGNITION ON mode, depress the brake pedal and move the shift lever.

■ Shift position uses

Shift position	Function
P	Parking the vehicle or starting the engine
R	Reversing
N	Neutral
D	Normal driving* ¹
S	“S” mode driving* ² (→P. 127)

*¹: To improve fuel consumption and reduce noises, set the shift lever in the “D” position for normal driving.

*²: By selecting shift ranges using “S” mode, you can control engine braking forces.

■ Selecting a driving mode

The following patterns can be selected to suit current driving and operating conditions.



1 Power mode

For powerful acceleration and driving in mountainous regions.

2 Normal mode

3 Snow mode

For accelerating and driving on slippery road surfaces, such as on snow.

Press "SNOW" to return to normal mode.



FarmaSOS.com

Changing shift ranges in "S" mode

Shift the shift lever to the "S" position and operate the shift lever.



- 1 Upshifting
- 2 Downshifting

► GS460

The initial shift range in "S" mode is automatically set to "7", "6", "5" or "4" according to vehicle speed. However, the initial shift range may not be set to "4" if the AI-SHIFT has operated while the shift lever was in the "D" position. (→P. 129)

► GS350

The initial shift range in "S" mode is automatically set to "5" or "4" according to vehicle speed. However, the initial shift range may be set to "3" or "2" if the AI-SHIFT has operated while the shift lever was in the "D" position. (→P. 129)

■ Shift ranges and their functions

- You can choose from 8 levels (GS460) or 6 levels (GS350) of engine braking force.
- A lower shift range will provide greater engine braking force than a higher shift range, and the engine revolutions will also increase.
- If you accelerate while in ranges “1” to “7” (GS460) or “1” to “5” (GS350), the shift range may automatically range up in accordance with the vehicle’s speed.

■ “S” mode

When the shift range is “6” (GS460) or “4” (GS350) or lower, holding the shift lever toward “+” sets the shift range to “8” (GS460) or “6” (GS350).

■ Downshifting restrictions warning buzzer (in the “S” mode)

To help ensure safety and driving performance, downshifting operation may sometimes be restricted. In some circumstances, downshifting may not be possible even when the shift lever is operated. (The warning buzzer will sound twice.)

■ When driving with the cruise control system (or dynamic radar cruise control system)

The engine brake will not operate in the “S” mode, even when downshifting to “7”, “6”, “5” or “4” (GS460) or “5” or “4” (GS350). (→P. 150, 153)

■ Snow mode automatic deactivation

Snow mode is automatically deactivated if the “ENGINE START STOP” switch is turned to ACCESSORY or IGNITION ON mode after driving in snow mode.

■ If the shift lever cannot be shifted from “P”

→P. 524

■ If the **S** indicator does not come on even after shifting the shift lever to “S”

This may indicate a malfunction in the automatic transmission. Have the vehicle inspected by your Lexus dealer immediately.

(In this situation, the vehicle will operate as if the shift lever is in “D”.)

■ **AI-SHIFT**

The AI-SHIFT automatically shifts the gear to the optimal position according to the driver’s input and driving conditions.

GS460: The AI-SHIFT automatically operates when the shift lever is in the “D” or “S” position.

GS350: The AI-SHIFT automatically operates when the shift lever is in the “D” position. (Shifting the shift lever to the “S” position cancels the function.)

امداد خودرو فارما

تلفن شبانه روزی: ۰۲۱-۸۸۶۲۰۸۵

FarmaSOS.com

2-1. Driving procedures

Turn signal lever

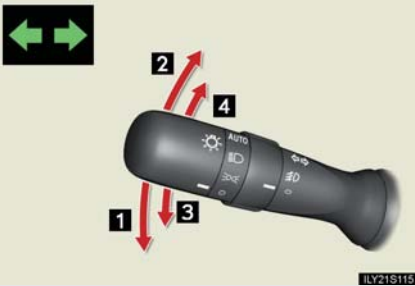

- 1 Left turn
- 2 Right turn
- 3 Move and hold the lever part-way to signal a lane change
The left hand signal will flash until you release the lever.
- 4 Move and hold the lever part-way to signal a lane change
The right hand signal will flash until you release the lever.

■ Turn signals can be operated when

The "ENGINE START STOP" switch is in IGNITION ON mode.

■ If the indicators flash faster than usual

Check that a light bulb in the front or rear turn signal lights has not burned out.

FarmaSOS.com

2-1. Driving procedures

Parking brake



Sets the parking brake*
(Depressing the pedal again releases the parking brake.)

*: Fully depress the parking brake pedal with your left foot while depressing the brake pedal with your right foot.

NOTICE

■ Before driving

Fully release the parking brake.

Driving the vehicle with the parking brake set will lead to brake components overheating, which may affect braking performance and increase brake wear.

تلفن شبانه روزی: ۰۲۱-۸۸۶۲۰۸۵

FarmaSOS.com

2-2. Instrument cluster

Gauges and meters



The units used on the speedometer may differ depending on the target region.

The following gauges, meters and display illuminate when the “ENGINE START STOP” switch is in IGNITION ON mode.

- 1 Tachometer تلفن شبانه روزی: ۰۲۱-۸۸۶۲۰۸۵
Displays the engine speed in revolutions per minute.
- 2 Speedometer FarmaSOS.com
Displays the vehicle speed.
- 3 Fuel gauge
Displays the quantity of fuel remaining in the tank.
- 4 Engine coolant temperature gauge
Displays the engine coolant temperature.
- 5 Multi-information display
→P.139

6 Odometer and trip meter

► Odometer

Displays the total distance the vehicle has been driven.

► Trip meter

Displays the distance the vehicle has been driven since the meter was last reset. Trip meters A and B can be used to record and display different distances independently.

Odometer/trip meter and trip meter reset buttons

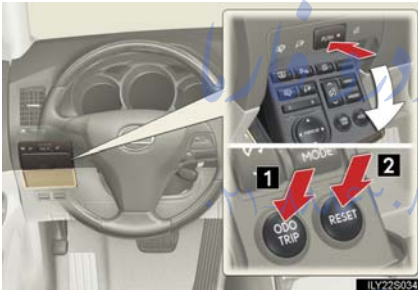

1 Changes the display

2 Resets the trip meter driving range to "0".

تلفن شبانه روزی: ۵۵۵

FarmaSOS.com

Instrument panel light control

The brightness of the instrument panel lights excluding the clock and outside temperature display, can be adjusted.



1 Brighter

2 Darker

3 Maximum brightness

Light sensitive optitron meter

To reduce glare or reflection of the instrument cluster, the cluster glass is tinted automatically or manually. You can select a setting from 7 modes.



- 1 Display the present setting, then change the mode.

To change the mode, press the button once and then again within 6 seconds.

Each time you press the button, the mode changes in the following order;

1. "AUTO - Norm"
2. "AUTO - Lo"
3. "AUTO - Hi"
4. "MANUAL - 1"
5. "MANUAL - 2"
6. "MANUAL - 3"
7. "MANUAL - 4"

Mode 1 to 3: The cluster glass tint will be adjusted automatically depending on the intensity of sunlight in the surrounding.

Mode 4 to 7: The cluster glass tint will be fixed when a certain level of sunlight is reached in the surrounding.

("Norm" to "Hi", "1" to "4" referring to the level of cluster glass tint.)

 NOTICE

■ To prevent damage to the engine and its components

- The engine may be overheating if the engine coolant temperature gauge is in the red zone ("H"). In this case, immediately stop the vehicle in a safe place. Check the engine after it has cooled completely. (→P. 533)
- Do not let the indicator needle of the tachometer enter the red zone, which indicates the maximum engine speed.

■ To activate the light sensitivity function properly

Do not affix a sticker or window tint to the rear window glass, or put an object behind the rear seat.

امداد خودرو فارما

تلفن شبانه روزی: ۰۲۱-۸۸۶۲۰۸۵

FarmaSOS.com

2-2. Instrument cluster

Indicators and warning lights

The indicator and warning lights on the instrument cluster and center panel inform the driver of the status of the vehicle's various systems.

► Instrument cluster



The units used on the speedometer and some indicators may differ depending on the target region. تلفن شبانه روزی: ۰۸۵-۸۸۶۲۰۸۱-۲۱

► Center panel



Indicators

The indicators inform the driver of the operating state of the vehicle's various systems.



Turn signal indicator
(→P. 130)



Damping mode indicator
(→P. 183)

(if equipped)



Headlight high beam indicator (→P. 142)



Shift position and shift range indicators
(→P. 127)



Headlight indicator
(→P. 142)

(U.S.A.)



Cruise control indicator
(→P. 153)



Tail light indicator
(→P. 142)

(Canada)



Intuitive parking assist indicator (→P. 165)

(if equipped)



Fog light indicator
(→P. 145)



Slip indicator (→P. 185)



* "AFS OFF" indicator
(→P. 143)

(if equipped)



"VSC OFF" indicator
(→P. 186)



* "ECT SNOW" indicator
(→P. 126)



* "AIR BAG ON" and "AIR BAG OFF" indicators
(→P. 92)



"ECT PWR" indicator
(→P. 126)

اندروید فارما
تلفن شبانه روزی: ۰۸۵-۸۸۶۲۰۸۵-۲۱
FarmaSO.com

■ Warning lights

Warning lights inform the driver of malfunctions in the indicated vehicle's systems. (→P. 488)



*: These lights turn on when the “ENGINE START STOP” switch is turned to IGNITION ON mode to indicate that a system check is being performed. They will turn off after the engine is on, or after a few seconds. There may be a malfunction in a system if the lights do not come on, or turn off. Have the vehicle inspected by your Lexus dealer.

! CAUTION

FarmaSOS.com

■ If a safety system warning light does not come on

Should a safety system light such as ABS and the SRS airbag warning light not come on when you turn to IGNITION ON mode, this could mean that these systems are not available to help protect you in an accident, which could result in death or serious injury. Have the vehicle inspected by your Lexus dealer immediately if this occurs.

Multi-information display

The multi-information display presents the driver with a variety of driving-related data, including the current driving range.



- Trip information (→P. 140)

Displays driving range, fuel consumption and other cruising related information.

- Intuitive parking assist display (if equipped) (→P. 166)

Automatically displayed when using intuitive parking assist.

- Dynamic radar cruise control display (if equipped) (→P. 153)

Automatically displayed when using dynamic radar cruise control.

- Warning messages (→P. 497)

Automatically displayed when a malfunction occurs in one of the vehicle's systems.

FarmaSOS.com



Display items can be switched by pushing the “DISP” switch.

Trip information

■ Driving range

RANGE APPROX
771 Mi

Displays the estimated maximum distance that can be driven with the quantity of fuel remaining.

- This distance is computed based on your average fuel consumption. As a result, the actual distance that can be driven may differ from that displayed.
- When only a small amount of fuel is added to the tank, the display may not be updated.

■ Average fuel consumption after refueling

TANK AVG
30.0 MPG

Displays the average fuel consumption since the vehicle was last refueled.

■ Current fuel consumption

CURRENT MPG
0 30 60 90

Displays the current rate of fuel consumption.

■ Outside temperature

OUTSIDE
77 °F

Displays the outside air temperature.

The temperature range that can be displayed is from -40°F (-40°C) to 122°F (50°C).

■ System check display

After switching the “ENGINE START STOP” switch to IGNITION ON mode, “CHECK” is displayed while system operation is checked. When the system check is complete, “COMPLETED” is displayed before returning to the normal screen.

NOTICE

■ The multi-information display at low temperatures

Allow the interior of the vehicle to warm up before using the liquid crystal information display. At extremely low temperatures, the information display monitor may respond slowly, and display changes may be delayed.

امداد خودرو فارما

تلفن شبانه روزی: ۰۲۱-۸۸۶۲۰۸۵

FarmaSOS.com

2-3. Operating the lights and windshield wipers

Headlight switch

The headlights can be operated manually or automatically.

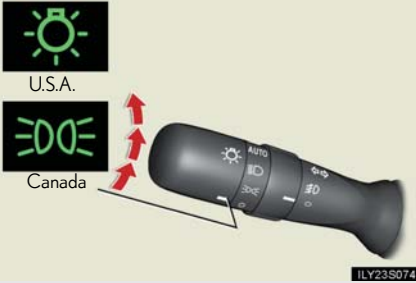

 The side marker, parking, tail, license plate and instrument panel lights turn on.

 The headlights and all lights listed above turn on.

AUTO The headlights and all the lights listed above turn on and off automatically. (When the "ENGINE START STOP" switch is in IGNITION ON mode.)

ایجاد خودرو فارما
تلفن شبانه روزی: ۰۲۱-۸۸۶۲۰۸۵

Turning on the high beam headlights

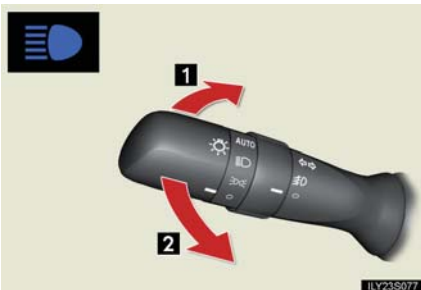

1 With the headlights on, push the lever forward to turn on the high beams.

Pull the lever back to the center position to turn the high beams off.

2 Pull the lever toward you to turn on the high beams.

Release to turn them off. You can flash the high beams with the headlights on or off.

AFS (Adaptive Front lighting System) (if equipped)

AFS improves visibility at intersections and on curves by automatically adjusting the level of the headlights according to vehicle speed and the degree of the tire angle that are controlled by steering input.

Operates at speeds of 6 mph (10 km/h) or higher.

■ Deactivating AFS



- 1 Press the switch to turn it off.

The **AFS OFF** indicator turns on when the AFS is deactivated.

2

When driving

■ Daytime running light system

To make your vehicle more visible to other drivers, the headlights turn on automatically (at a reduced intensity) whenever the engine is started and the parking brake is released. Daytime running lights are not designed for use at night.

■ Headlight control sensor

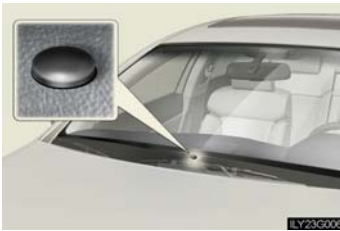

The sensor may not function properly if an object is placed on the sensor, or anything that blocks the sensor is affixed to the windshield.

Doing so interferes with the sensor detecting the level of ambient light and may cause the automatic headlight system to malfunction.

تلفن شبانه روزی: ۰۲۱-۸۸۶۲۰۸۵

Family303.com

■ Automatic light off system

The headlights and tail lights turn off 30 seconds after all doors are closed if the “ENGINE START STOP” switch has been switched to ACCESSORY mode or turned OFF while the headlights are turned on. (The lights turn off immediately if the  button on the key is pressed after all doors are locked.)

To turn the lights on again, switch to IGNITION ON mode, or turn the light switch off once and then back to the  or  position.

■ Automatic headlight leveling system

The level of the headlights is automatically adjusted according to the number of passengers and the loading condition of the vehicle to ensure that the headlights do not interfere with other road users.

■ If the indicator flashes...

It may indicate a malfunction in the system. Contact your Lexus dealer.

■ Customization that can be configured at Lexus dealer

Settings (e.g. light sensor sensitivity) can be changed.
(Customizable features →P. 572)



NOTICE

تلفن شبانه روزی: ۰۲۱-۸۸۶۲۰۸۵

■ To prevent 12 volt battery discharge

Do not leave the lights on longer than necessary when the engine is off.

FarmaSOS.com

2-3. Operating the lights and windshield wipers

Fog light switch

The fog lights improve visibility in difficult driving conditions, such as in rain or fog. They can be turned on only when the headlights are on low beam.

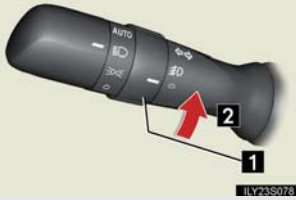

- 1 OFF
- 2 ON

امداد خودرو فارما

تلفن شبانه روزی: ۰۲۱-۸۸۸۶۲۰۸۵

FarmaSOS.com

2-3. Operating the lights and windshield wipers

Windshield wipers and washer

■ Intermittent wiper with interval adjuster

Wiper intervals can be adjusted for intermittent operation (when  is selected).



- 1 Decreases the intermittent windshield wiper frequency
- 2 Increases the intermittent windshield wiper frequency
- 3 Intermittent wiper operation
- 4 Low speed wiper operation
- 5 High speed wiper operation
- 6 Temporary operation
- 7 Wash/wipe operation

■ Rain-sensing windshield wipers

With "AUTO" selected, the wipers will operate automatically when the sensor detects falling rain. The system automatically adjusts wiper timing in accordance with rain volume and vehicle speed.

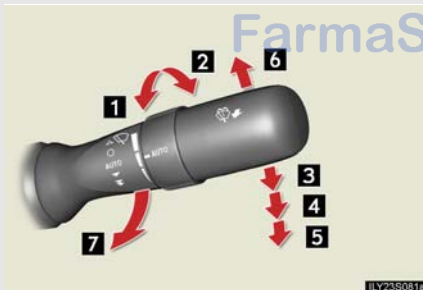

- 1 Sensor sensitivity (low)
- 2 Sensor sensitivity (high)
- 3 Rain-sensing wiper operation
- 4 Low speed wiper operation
- 5 High speed wiper operation
- 6 Temporary operation
- 7 Wash/wipe operation

■ The windshield wiper and washer can be operated when

The "ENGINE START STOP" switch is in IGNITION ON mode.

■ Dripping prevention wiper sweep

After washing and wiping operation several times, the wipers operate one more time after a short delay to prevent dripping.

However, the last sweep will not happen if the vehicle is traveling above 106 mph (170 km/h).

■ Effects of vehicle speed on wiper operation

Vehicle speed affects the following even when the wipers are not "AUTO" mode.

- Intermittent wiper interval ( mode)
- Wiper operation when the washer is being used (delay until drip prevention wiper sweep occurs)

With  selected, wiper operation will be switched from low speed to intermittent wiper operation only when the vehicle is stationary.

■ Rain drop sensor (vehicles equipped with rain-sensing windshield wipers)



The sensor judges the amount of raindrops.

2-3. Operating the lights and windshield wipers

■ If no windshield washer fluid sprays

Check that the washer nozzles are not blocked if there is washer fluid in the windshield washer fluid reservoir.

■ In extremely hot or cold weather

The system will turn off if the windshield gets extremely hot (at more than 176°F [80°C]) or cold (at less than 14°F [-10°C]).

■ Customization that can be configured at Lexus dealer

Settings (e.g. drip prevention function) can be changed.
(Customizable features →P. 573)

⚠ CAUTION

■ Caution regarding the use of windshield wipers in "AUTO" mode

The windshield wipers may operate unexpectedly if the sensor is touched or the windshield is subject to vibration in "AUTO" mode. Take care that your fingers or anything else do not become caught in the windshield wipers.

⚠ NOTICE

■ When the windshield is dry

Do not use the wipers, as they may damage the windshield.

■ When there is no washer fluid spray from the nozzle

Damage to the washer fluid pump may be caused if the lever is pulled toward you and held continually.

2-3. Operating the lights and windshield wipers Headlight cleaner switch (if equipped)

Washer fluid can be sprayed on the headlights.



1 Press the switch to clean the headlights.

■ The headlight cleaner can be operated when

The "ENGINE START STOP" switch is in IGNITION ON mode and the headlight switch is turned ON.

⚠ NOTICE

تلفن شبانه روزی: ۰۲۱-۸۸۶۲۰۸۵

■ When the washer fluid tank is empty

Do not use this function, as the washer fluid pump may overheat.

2-4. Using other driving systems

Cruise control

Use the cruise control to maintain a set speed without using the accelerator.

■ Set the vehicle speed



Press the "ON-OFF" button to activate the cruise control.

Press the button once more to deactivate the cruise control.



Accelerate or decelerate to the desired speed and press the lever down to set the cruise control speed.

■ Adjusting the speed setting



1 Increase speed

2 Decrease speed

Hold the lever until the desired speed setting is obtained.

Fine adjustment of the set speed (approximately 1.0 mph [1.6 km/h]) can be made by lightly pressing the lever up or down and releasing it.

■ Canceling and resuming regular acceleration



1 Cancel

Pull the lever towards you to cancel cruise control.

The setting is also canceled when the brake pedal is depressed.

2 Resume

To resume cruise control and return to the set speed, push the lever up.

2

When driving

■ Cruise control can be set when

- The shift lever is in the "D" or "4", "5", "6", "7" or "8" (GS460) or "4", "5", or "6" (GS350) range of "S", *تلفن شبانه روزی: ۰۸۵-۸۸۶۲۰۸۵*
- Vehicle speed is between approximately 25 mph (40 km/h) and 125 mph (200 km/h).

■ Accelerating

FarmaSOS.com

The vehicle can be accelerated normally. After acceleration, the set speed resumes.

■ Automatic cruise control cancelation

The set speed is automatically canceled in any of the following situations.

- Actual vehicle speed falls more than 10 mph (16 km/h) below the preset vehicle speed
At this time, the memorized set speed is not retained.
- Actual vehicle speed is below 25 mph (40 km/h)
- VSC is activated

■ If the cruise control indicator light flashes

Turn the "ON-OFF" button off once, and then reactivate the system.

If the cruise control speed cannot be set or if the cruise control cancels immediately after being activated, there may be a malfunction in the cruise control system. Have the vehicle inspected by your Lexus dealer.

CAUTION

■ To avoid operating the cruise control by mistake

Keep the "ON-OFF" button off when not in use.

■ Situations unsuitable for cruise control

Do not use cruise control in any of the following situations.

Doing so may result in control of the vehicle being lost and could cause serious or fatal accident.

- In heavy traffic
- On roads with sharp bends
- On slippery roads, such as those covered with rain, ice or snow
- On steep hills
Vehicle speed may exceed the set speed when driving down a steep hill.
- On winding roads

FarmaSOS.com

2-4. Using other driving systems

Dynamic radar cruise control (if equipped)

Dynamic radar cruise control supplements conventional cruise control with a vehicle-to-vehicle distance control. In the vehicle-to-vehicle distance control mode, the vehicle automatically accelerates or decelerates in order to maintain a set following distance from vehicles ahead.

■ Set the vehicle speed



Press the "ON-OFF" button to activate the cruise control.

Press the button once more to deactivate.



Accelerate or decelerate to the desired speed and press the lever down to set.

■ Selecting conventional constant speed control mode



1 Press the “ON-OFF” button to activate the cruise control.

Press the button once more to deactivate the cruise control.

2 Switch to constant speed control mode.
(Push the lever away from you and hold for approximately 1 second.)

Vehicle-to-vehicle distance control mode is always reset when the “ENGINE START STOP” switch is switched to IGNITION ON mode.

■ Adjusting the speed setting



1 Increase speed

2 Decrease speed

Hold the lever until the desired speed setting is displayed.

In the constant speed control mode, fine adjustment of the set speed (approximately 1.0 mph [1.6 km/h]) can be made by lightly pressing the lever up or down and releasing it.

■ Canceling and resuming the speed setting

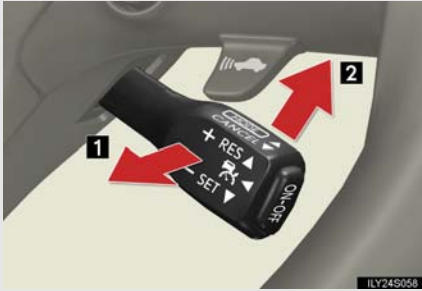

1 Cancel

Pull the lever towards you to cancel cruise control.

The setting is also canceled when the brake pedal is depressed.

2 Resume

To resume cruise control and return to the set speed, push the lever up.

■ Changing the vehicle-to-vehicle distance

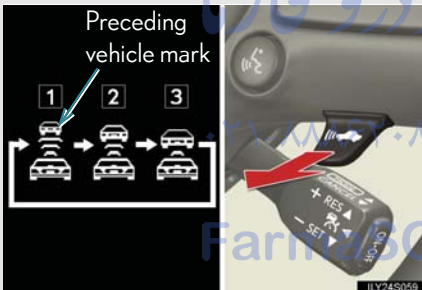

Each pull of the switch changes the vehicle-to-vehicle distance

1 Long

2 Medium

3 Short

The vehicle-to-vehicle distance is automatically set to the long mode when the "ENGINE START STOP" switch is set to the IGNITION ON mode.

A mark will be displayed to indicate the presence of the vehicle if a vehicle is running ahead of you.

Cruising in vehicle-to-vehicle distance control mode

This mode employs a radar sensor to detect the presence of vehicles within 400 ft. (120 m) ahead and to judge the distance between your vehicle and those vehicles.

Note that vehicle-to-vehicle distance will close when traveling on long downhill slopes.

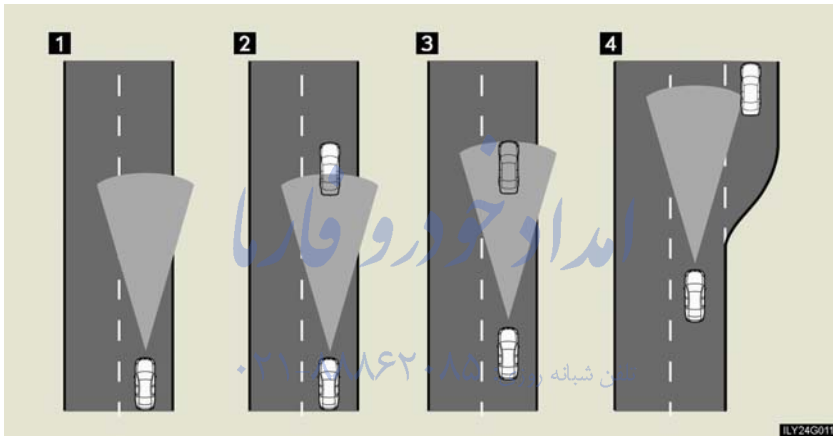

- 1 Example of constant speed cruising
When there are no vehicles ahead

The vehicle travels at the speed set by the driver. The desired vehicle-to-vehicle distance can also be set by operating the vehicle-to-vehicle distance switch.

- 2 Example of deceleration cruising
When the vehicle ahead is driving slower than the set speed

When a vehicle is detected running ahead of you, in the same lane, the system automatically decelerates your vehicle. When a greater reduction in vehicle speed is necessary, the system applies the brakes. A warning tone warns you when the system cannot decelerate sufficiently to prevent your vehicle from closing on the vehicle ahead.

3 Example of follow-up cruising

When following a vehicle driving slower than the set speed

The system continues follow-up cruising while adjusting for changes in the speed of the vehicle ahead in order to maintain the vehicle-to-vehicle distance set by the driver.

4 Example of acceleration

When there are no longer vehicles driving slower than the set speed in the lane ahead

When the vehicle ahead of you executes a lane change, the system slowly accelerates until the set vehicle speed is reached. The system then returns to fixed speed cruising.

Approach warning

When your vehicle is too close to a vehicle ahead, and sufficient automatic deceleration via the cruise control is not possible, the display will flash and buzzer will sound to alert the driver. An example of this would be if another driver cuts in front of you while you are following a vehicle. Apply the brakes to ensure an appropriate vehicle-to-vehicle distance.

Warning lights and messages for dynamic radar cruise control

Warning lights, messages and buzzers are used to indicate a system malfunction or to inform the driver of the need for caution while driving. (→P. 500)

Switching modes

The mode cannot be switched to constant speed control mode if vehicle-to-vehicle distance control mode has been used. The mode also cannot be switched from constant speed control to vehicle-to-vehicle control mode. Turn the system off by pressing the "ON-OFF" button, and turn it on again.

■ The dynamic radar cruise can be set when

- The shift lever is in "D" or the "4", "5", "6", "7" or "8" (GS460) or "4", "5" or "6" (GS350) range of "S".
- Vehicle speed is between approximately 27 mph (43 km/h) and 87 mph (139 km/h).

■ Accelerating

The vehicle can be accelerated normally.

■ Automatically canceling vehicle-to-vehicle distance control

Vehicle-to-vehicle distance control driving is automatically canceled in the following situations.

- Actual vehicle speed falls below 25 mph (40 km/h)
- VSC is activated
- The windshield wipers are operating at high speed
- The mode select switch is set to snow mode
- The sensor cannot operate correctly because it is covered in some way
Vehicle-to-vehicle distance control driving must be reset by turning the "ON-OFF" button on again.

If vehicle-to-vehicle distance control driving is automatically canceled for any other reason, there may be a malfunction in the system. Contact your Lexus dealer.

■ Automatically canceling constant speed control

The set speed is automatically canceled in the following situations.

- Actual vehicle speed is more than 10 mph (16 km/h) below the preset vehicle speed
- Actual vehicle speed falls below 25 mph (40 km/h)
- VSC is activated

■ Vehicle-to-vehicle distance settings

Select a distance from the table below. Note that the distances shown correspond to a vehicle speed of 50 mph (80 km/h). Vehicle-to-vehicle distance increases/decreases in accordance with vehicle speed.

Distance options	Vehicle-to-vehicle distance
Long	Approximately 210 ft. (65 m)
Medium	Approximately 150 ft. (45 m)
Short	Approximately 100 ft. (30 m)

■ Radar sensor and grille cover

Always keep the sensor and grille cover clean to ensure that the vehicle-to-vehicle distance control operates properly. (Some obstructions, such as snow, ice or plastic objects, cannot be detected by the obstruction sensor.)

Dynamic radar cruise control is canceled if an obstruction is detected.



1 Grille cover

2 Radar sensor

تلفن شبانه روزی: ۰۲۱-۸۸۶۲۰۸۵

FarmaSOS.com

■ Certification

- For vehicles sold in the U.S.A.

FCC WARNING

Changes or modifications not expressly approved by the party responsible for compliance could void the user's authority to operate the equipment.

FCC RF exposure information

This device complies with the FCC RF exposure requirements.

- For vehicles sold in Canada

Operation is subject to the following two conditions;

- (1) This device may not cause interference, and
- (2) This device must accept any interference received, including interference that may cause undesired operation of the device.

تلفن شبانه روزی: +۸۵-۸۸۶۲-۰۲۱

FarmaSOS.com

! CAUTION**■ Before using dynamic radar cruise control**

Do not overly rely on vehicle-to-vehicle distance control.

Be aware of the set vehicle speed. If automatic deceleration/acceleration is not appropriate, adjust the vehicle speed, as well as the distance between your vehicle and vehicles ahead by applying the brakes, etc.

■ To avoid operating the dynamic radar cruise control by mistake

Keep the "ON-OFF" button off when not in use.

■ Situations unsuitable for dynamic radar cruise control

Do not use dynamic radar cruise control in any of the following situations.

Doing so may result in inappropriate control of speed and could cause serious or fatal accident.

- In heavy traffic
- On roads with sharp bends
- On winding roads
- On slippery roads, such as those covered with rain, ice or snow
- On steep downhill, where there are sudden changes between sharp up and down gradients
Vehicle speed may exceed the set speed when driving down a steep hill.
- At entrances to expressways
- When weather conditions are bad enough that they may prevent the sensors from functioning correctly (fog, snow, sandstorm, etc.)
- When the approach warning buzzer can be heard often

⚠ CAUTION

■ **When the radar sensor may not be correctly detecting the vehicle ahead**

Apply the brakes as necessary when any of the following types of vehicles are in front of you.

As the sensor may not be able to correctly detect these types of vehicles, the proximity alarm (→P. 506) will not be activated, and an accident may result.

- Vehicles that cut in suddenly
- Vehicles traveling at low speeds
- Vehicles that are not moving
- Vehicles with small rear ends (trailers with no load on board etc.)
- Motorcycles traveling in the same lane

■ **Conditions under which the vehicle-to-vehicle distance control may not function correctly**

Apply the brakes as necessary in the following conditions as the radar sensor may not be able to correctly detect vehicles ahead, and an accident may result.

- When water or snow thrown up by the surrounding vehicles hinders the functioning of the sensor
- When your vehicle is pointing upwards (caused by a heavy load in the trunk, etc.)
- When the road curves or when the lanes are narrow
- When steering wheel operation or your position in the lane is unstable
- When the vehicle ahead of you decelerates suddenly

 **CAUTION**
■ To ensure the radar sensor functions correctly

Do not do the following to the sensor or grille cover as doing so may cause the sensor not to function correctly and could result in an accident.

- Stick or attach anything to them
- Leave them dirty
- Disassemble, subject them to strong shocks
- Modify or paint them
- Replace them with non-genuine parts

■ Handling the radar sensor

Observe the following to ensure the cruise control system can function effectively.

- Keep the sensor and front grille clean at all times.
Clean the sensor and front grille with a soft cloth so you do not mark or damage them.
- Do not subject the sensor or surrounding area to a strong impact.
If the sensor moves even slightly off position, the system may malfunction. If the sensor or surrounding area is subject to a strong impact, always have the area inspected and adjusted by a Lexus dealer.
- Do not disassemble the sensor.
- Do not attach accessories or stickers to the sensor, grille or surrounding area.
- Do not modify or paint the sensor and grille.

2-4. Using other driving systems

Intuitive parking assist (if equipped)

Intuitive parking assist uses sensors in the front and rear of the vehicle to detect the distance between the vehicle and any obstacles, and informs the driver of this distance using the multi-information display, the touch screen, and warning beeps.

The system may be used at speeds less than about 6 mph (10 km/h).

■ Sensor types



1 Dual sensors

There are 4 sensors installed in the front bumper, two in the center section to detect obstacles directly ahead, and one in each corner of the bumper, to detect obstacles in those areas.

The dual sensors detect obstacles ahead of the vehicle, and judge whether avoidance maneuvers are necessary (whether the obstacle will come within 0.8 ft. [25 cm] of the vehicle), according to the distance between the obstacle and the vehicle, and the steering wheel position. The screen display and beeps will change accordingly.

2 Rear corner sensors

These sensors detect obstacles around the rear corners of the vehicle.

3 Back sensors

These sensors detect obstacles behind the vehicle.

■ Intuitive parking assist switch



- 1 Press the switch to turn the system on/off.

If the intuitive parking assist is turned on, the indicator light will come on, and the system will operate under the following conditions:

- The dual sensors will operate if the shift lever is in a position other than "R" or "P".
- All corner sensors and the back sensors will operate if the shift lever is in "R".

تلفن شبانه روزی: ۰۲۱-۸۸۷۷۱۰۵

FarmaSOS.com

Multi-information display and touch screen

If the sensors detect an obstacle, it is displayed on the multi-information display in the instrument cluster.

You can change the conditions under which information is displayed on the touch screen. (→P.173)

► Multi-information display

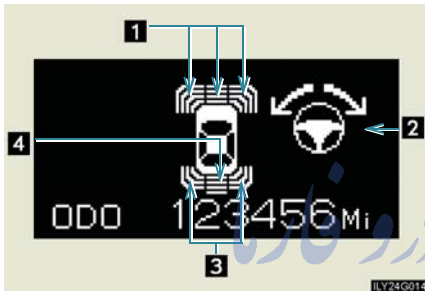

- 1 Dual sensor detection
- 2 Steering guide symbol
- 3 Rear corner sensor detection
- 4 Back sensor detection

► Touch screen













- 1 Dual sensor detection
- 2 Steering guide symbol
- 3 Rear corner sensor detection
- 4 Back sensor detection

If the intuitive parking assist is operated while the rear view monitor is showing, the intuitive parking assist will be shown in the upper right corner of the screen. (→P.169)

Sensor detection display, obstacle distance and beeps







When the intuitive parking assist is activated, the approximate distance to the obstacle is displayed. Also, if an obstacle with which a collision is possible is detected, a warning beep will sound.

Dual sensor









Approximate distance to obstacle	Multi-information display	Touch screen	
		With beeps (danger of collision)	No beeps (no danger of collision)
3.0 ft. (100 cm) to 1.5 ft. (50 cm)	 (continuous)	 (continuous)	 (continuous)
1.5 ft. (50 cm) to 1.1 ft. (37.5 cm)	 (continuous)	 (continuous)	 (continuous)
1.1 ft. (37.5 cm) to 0.8 ft. (25 cm)	 (continuous)	 (continuous)	 (continuous)
Less than 0.8 ft. (25 cm)	 (blinking)	 (continuous)	—

- If the shift lever is in "R", only the corner sensors will detect obstacles.

Rear corner sensor

Approximate distance to obstacle	Multi-information display	Touch screen
1.5 ft. (50 cm) to 11 ft. (37.5 cm)	 (continuous)	 (continuous)
11 ft. (37.5 cm) to 0.8 ft. (25 cm)	 (continuous)	 (continuous)
Less than 0.8 ft. (25 cm)	 (blinking)	 (continuous)

Back sensor

Approximate distance to obstacle	Multi-information display	Touch screen
5.0 ft. (150 cm) to 2.0 ft. (60 cm)	 (continuous)	 (continuous)
2.0 ft. (60 cm) to 1.4 ft. (45 cm)	 (continuous)	 (continuous)
1.4 ft. (45 cm) to 1.1 ft. (35 cm)	 (continuous)	 (continuous)
Less than 1.1 ft. (35 cm)	 (blinking)	 (continuous)



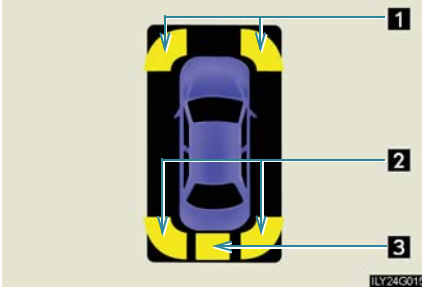



Touch screen (insert display)



- 1** Dual sensor (corner) detection
- 2** Rear corner sensor detection
- 3** Back sensor detection



The tire display and the steering guide symbol will not be displayed.

Dual sensor

Approximate distance to obstacle	With beeps (danger of collision)	No beeps (no danger of collision)
3.0 ft. (100 cm) to 1.5 ft. (50 cm)	 (blinking slowly)	 (continuous)
1.5 ft. (50 cm) to 1.1 ft. (37.5 cm)	 (blinking)	 (continuous)
1.1 ft. (37.5 cm) to 0.8 ft. (25 cm)	 (blinking rapidly)	 (continuous)
Less than 0.8 ft. (25 cm)	 (continuous)	—

2
When driving

Rear corner sensor

Approximate distance to obstacle	Touch screen
1.5 ft. (50 cm) to 11 ft. (37.5 cm)	 (blinking)
11 ft. (37.5 cm) to 0.8 ft. (25 cm)	 (blinking rapidly)
Less than 0.8 ft. (25 cm)	 (continuous)

Back sensor

Approximate distance to obstacle	Touch screen
5.0 ft. (150 cm) to 2.0 ft. (60 cm)	 (blinking slowly)
2.0 ft. (60 cm) to 1.4 ft. (45 cm)	 (blinking)
1.4 ft. (45 cm) to 1.1 ft. (35 cm)	 (blinking rapidly)
Less than 1.1 ft. (35 cm)	 (continuous)

Steering guide symbol

Displays the steering maneuvers required to avoid an obstacle. Move the steering wheel in the direction shown by the arrow.

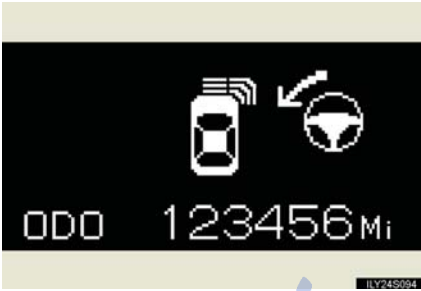

The steering guide symbol only shows the maneuvers necessary to avoid an obstacle.

When using the system, always check your surroundings for safety.

Beeps and obstacle distance

A beep sounds when an obstacle with which there is a danger of collision is detected. As the vehicle moves closer to the obstacle, the interval of the beep becomes shorter.

- When the following obstacle distances are reached, the beep changes from intermittent to continuous:
 - If the distance to the obstacle detected by the dual sensors or rear corner sensors is less than 0.8 ft. (25 cm).
 - If the distance to the obstacle detected by the back sensors is less than 1.1 ft. (35 cm).
- If obstacles are detected by the dual sensors in 2 places at once, or if both rear corner sensors detect obstacles at the same time, the system will sound a warning beep for the closer of the 2 obstacles.

- If multiple obstacles are detected in front and behind the vehicle at the same time, the warning beep will change in the following manner:
 - If an obstacle has been detected within 0.8 ft. (25 cm) of the front or rear of the vehicle (a continuous beep is sounding), and a new obstacle is detected near a different area of the vehicle, the warning beep will sound 6 beeps then one continuous beep.
 - If an obstacle has been detected within 0.8 ft. (25 cm) of the front or rear of the vehicle (a continuous beep is sounding), and a new obstacle is detected within 0.8 ft. (25 cm) of a different area of the vehicle, the warning beeps will sound 2 beeps then one continuous beep.
- You can change the volume of the warning beeps. (→P. 173)

Obstacle detection range

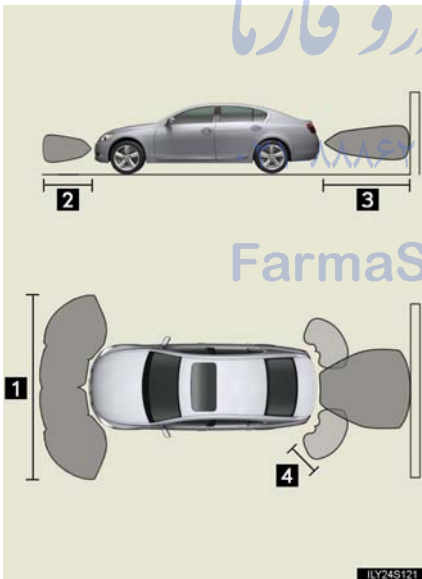

1 About 10.0 ft. (300 cm)

2 About 3.0 ft. (100 cm)

3 About 5.0 ft. (150 cm)

4 About 1.5 ft. (50 cm)

The detection area of the sensors is shown to the left.

If obstacles move too close to the sensors, they will not be detected.

If the malfunction screen is displayed, the dual sensor detection range will be shortened from 3.0 ft. (100 cm) to 1.5 ft. (50 cm).

Warning beep volume and touch screen settings

You can change the warning beep volume and touch screen operating conditions.

Press  to display the "Information" screen. Then touch .

■ Changing the warning beep volume



STEP 1 Touch .

STEP 2 Adjust the beep volume, then touch .

■ Changing the touch screen operating conditions

STEP 1 Touch .

STEP 2 Set one of the following operating condition, then touch .

- : Displays when the sensors detect an obstacle.
- : Displays if maneuvers are required to avoid an obstacle (if an obstacle is likely to come within 0.8 ft. [25 cm] of the vehicle).
- : Does not display the intuitive parking assist detection screen.

When an obstacle is detected while the rear view monitor is in use, the warning indicator will appear in the top right of the screen even  has been selected.

■ The intuitive parking assist can be operated when

The "ENGINE START STOP" switch is in the IGNITION ON mode.

■ When the system malfunctions

- If a malfunction occurs and no obstacles have been detected, a warning is displayed, and a malfunction beep sounds for 7 seconds.
If an obstacle has been detected, or another malfunction occurs in a different sensor, the malfunction beeps will not sound.
- In the following circumstances the displayed warning will disappear:
 - If you switch the screen to a different mode.
 - If you turn off the intuitive parking assist main switch.
 - If the vehicle speed exceeds 6 mph (10 km/h). Once the vehicle speed drops below 6 mph (10 km/h), the warning will be displayed again.
- If the malfunction screen is displayed, the detection range of the dual sensors is shortened. In this case, the necessity for obstacle evasion (whether the obstacle will come within 0.8 ft. [25 cm] of the vehicle or not) will not be calculated.

تلفن شبانه روزی: ۰۲۱-۸۸۶۲۰۸۵

FarmaSOS.com

■ When using the intuitive parking assist

- The sensors' detection areas and reaction times are limited. When moving forward or reversing, check the areas surrounding the vehicle (especially the sides of the vehicle) for safety, and drive slowly, using the brake to control the vehicle's speed.
 - The sensors' detection areas are limited to the areas around the vehicle's front and rear bumpers.
 - Depending on the shape of the obstacle and other factors, the detection distance may shorten, or detection may be impossible.
 - There will be a short delay between obstacle detection and display. Even at slow speeds, there is a possibility that the obstacle will come within 0.8 ft. (25 cm) of the vehicle before the display is shown and the warning beep sounds.
 - Braking distance may differ according to the road conditions (rain, gravel etc.).
 - It might be difficult to hear beeps due to the volume of audio system or air flow noise of air conditioning system.
 - For long obstacles such as walls, the obstacle warning may change as the obstacle gets closer.

تلفن شبانه روزی: ۰۲۱-۸۸۶۲۰۸۵

FarmaSOS.com

- In the following situations, the intuitive parking assist may not function correctly, possibly leading to an accident.
 - There is ice, snow or mud on the sensors. (Wiping the sensors will resolve this problem.)
 - The sensor area is frozen. (Thawing the area will resolve this problem.)
In especially cold weather, if a sensor is frozen the screen may show an abnormal display, or obstacles may not be detected.
 - The vehicle angle is especially wide.
 - In harsh sunlight or intense cold weather.
 - When driving on bumpy, sloped or gravel roads, or over grass.
 - If there is something producing ultrasonic waves nearby, such as another vehicle's horn, motorcycle engine noise, air braking sound from heavy-duty vehicles, or another vehicle using the intuitive parking assist.
 - In heavy rain, or if water is splashed on the sensors.
 - If a commercial fender pole or radio antenna is installed.
 - If towing eyelet is installed on your vehicle.
 - If moving towards a high curb or a curb corner.
 - Objects such as signs may cause the detection distance to shorten.
 - The area directly under the bumpers is not detected.
Objects lower than the sensors or thin stakes etc. may be detected initially, but as they draw closer, they may cease to be detected.
 - If obstacles draw too close to the sensor.

■ Obstacles that may not be detected correctly

The following obstacles may not be detected.

- Thin objects such as wire, fencing or rope.
- Objects that absorb sound waves, such as cotton or snow.
- Objects with sharp corners.
- Objects where the upper section projects out over the lower section.
- Low objects.

■ If the display flashes and a message is displayed

→P. 507

■ Certification

- ▶ For vehicles sold in the U.S.A.

This device complies with Part 15 of the FCC Rules.

Operation is subject to the following two conditions;

- (1) This device may not cause harmful interference, and
- (2) This device must accept any interference received, including interference that may cause undesired operation.

- ▶ For vehicles sold in Canada

This ISM device complies with Canadian ICES-001.

Cet appareil ISM est conforme à la norme NMB-001 du Canada.

⚠ CAUTION

■ While driving

To reduce the chance of injury in the event of an accident or sudden stop, keep the switch box closed.

■ When using the intuitive parking assist

Observe the following precautions.

- The back sensors and rear corner sensors do not judge whether there is danger of a collision, nor whether the obstacle can be avoided using the steering wheel. When reversing, always check your surroundings and behind the vehicle for safety.
- The steering guide symbol (arrow) is an approximate guide regarding obstacles. It is not driving instructions. When moving forward or reversing, always check your surroundings for safety and drive carefully.
- Do not install accessories within the sensors' detection areas, as this may cause the intuitive parking assist to function incorrectly, possibly leading to an accident.

 NOTICE

■ **When using the intuitive parking assist**

In the following situations, the system may not function correctly due to a sensor malfunction etc. Have the vehicle checked by your Lexus dealer.

- A beep does not sound when you turn the main switch on.
- The intuitive parking assist operation display flashes, and a beep sound when no obstacle has been detected.
- If the area around a sensor collides with something, or is subjected to strong impact.
- If the bumper collides with something.
- If the display shows continuously without a beep.

■ **When changing tires**

If you install tires of a size other than that recommended by the manufacturer, the system will be unable to correctly detect steering wheel movement. Always use tire sizes recommended by the manufacturer.

■ **When washing the vehicle**

When washing the vehicle using high pressure cleaning equipment, do not spray water directly on the sensors. Subjecting the sensors to high pressure impact may cause a malfunction.

FarmaSOS.com

2-4. Using other driving systems

Rear view monitor system (if equipped)

The rear view monitor system assists the driver by displaying an image of the view behind the vehicle while reversing. The image is displayed in reverse on the screen. This allows the image to appear in the same manner as that of the rear view mirror.



Rear view image is displayed when the shift lever is in "R".

If you move the lever out of "R", the screen returns to the previous one.



■ Rear view monitor system camera



In the following cases, it may be difficult to see the images on the screen, even when the system is functioning correctly.

- In the dark (e.g. at night).
- If the temperature near the lens is extremely high or low.
- If water droplets get on the camera, or when humidity is high (e.g. when it rains).
- If foreign matter (e.g. snow or mud) get on the camera lens.
- If the sun or headlights are shining directly into the camera lens.

■ Smear effect

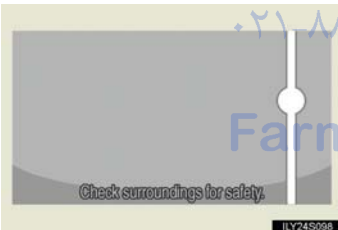

If a bright light (for example, sunlight reflected off the vehicle body) is picked up by the camera, a smear effect* peculiar to the camera may occur.

*: Smear effect—A phenomenon that occurs when a bright light (for example, sunlight reflected off the vehicle body) is picked up by the camera; when transmitted by the camera, the light source appears to have a vertical streak above and below it.

 **CAUTION**
■ When using the rear view monitor system

Observe the following precautions to avoid an accident that could result in death or serious injuries.

- Never depend solely on the monitor system when reversing.
- Always check visually and with the mirrors to confirm your intended path is clear.
- Depicted distances between objects and flat surfaces differ from actual distances.
- Do not use the system if the trunk is open.

■ Conditions which may affect the rear view monitor system

- If the back of the vehicle is hit, the camera's position and mounting angle may change. Contact your Lexus dealer.
- Rapid temperature changes, such as when hot water is poured on the vehicle in cold weather, may cause the system to function abnormally.
- If the camera lens is dirty, it cannot transmit a clear image. Rinse with water and wipe with a soft cloth. If extremely dirty, wash with a mild cleanser and rinse.
- The displayed image may be darker and moving images may be slightly distorted when the system is cold.

 NOTICE

■ Displayed area

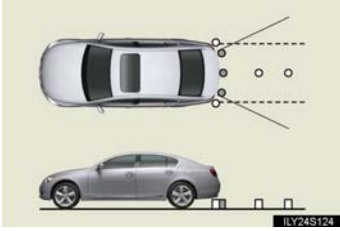

The area covered by the camera is limited. Objects which are close to either corner of the bumper or under the bumper cannot be seen on the screen.

The area displayed on the screen may vary according to vehicle orientation or road conditions.

► Corner of bumper

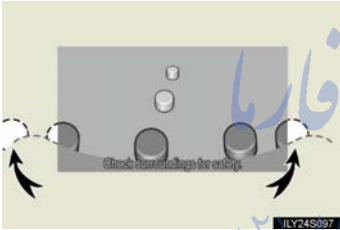

تلفن شبانه روزی: ۰۲۱-۸۸۸۶۲۰۸۵

FarmaSOS.com

2-4. Using other driving systems

AVS (Adaptive Variable Suspension System) (if equipped)

AVS controls the suspension according to the road and driving conditions. Selecting an optimum driving mode allows good vehicle posture and steering wheel operation in conjunction with VGRS, EPS and active stabilizer suspension system (if equipped).



1 Sports mode

For winding mountain road driving or high speed driving.

2 Normal mode

For normal driving.

2-4. Using other driving systems

Driving assist systems

To help enhance driving safety and performance, the following systems operate automatically in response to various driving situations. Be aware, however, that these systems are supplementary and should not be relied upon too heavily when operating the vehicle.

■ ABS (Anti-lock Brake System)

Helps to prevent wheel lock when the brakes are applied suddenly, or if the brakes are applied while driving on a slippery road surface.

■ Brake assist

Generates an increased level of braking force after the brake pedal is depressed, when the system detects a panic stop situation.

■ VSC (Vehicle Stability Control)

Helps the driver to control skidding when swerving suddenly or turning on slippery road surfaces.

■ TRAC (Traction Control)

Maintains drive power and prevents the rear wheels from spinning when starting the vehicle or accelerating on slippery roads.

■ Hill-start assist control

Helps prevent the vehicle from rolling backwards when starting on an incline or slippery slope. It operates for approximately 5 seconds at maximum.

■ EPS (Electric Power Steering)

Employs an electric motor to reduce the amount of effort needed to turn the steering wheel.

■ Active stabilizer suspension system (if equipped)

Turns at smaller angles to maintain the stable vehicle posture.

■ PCS (Pre-Collision System) (if equipped)

→P.190

■ VGRS (Variable Gear Ratio Steering) (GS460)

Adjusts the wheel turning angle in accordance with the vehicle speed and steering wheel movement.

■ VDIM (Vehicle Dynamics Integrated Management)

Provides integrated control of the ABS, VSC, TRAC, hill-start assist control, VGRS (GS460) and EPS systems.

Maintains vehicle stability when swerving on slippery road surfaces by controlling the brakes, engine output, and the movement of the front wheels.

When the VSC/TRAC/hill-start assist control systems are operating



If the vehicle is in danger of slipping, rolling backwards when starting on an incline, or if the rear wheels (2WD models) or all wheels (4WD models) spin, the slip indicator light flashes to indicate that the VSC/TRAC/hill-start assist control systems have been engaged.

A buzzer (intermittent) sounds to indicate that VSC is operating.

The stop lights and high mounted stoplight turn on when the hill-start assist control system is operating.

The slip indicator light flashes as well when ABS is operating.

To disable TRAC and/or VSC

If the vehicle gets stuck in fresh snow or mud, TRAC and VSC may reduce power from the engine to the wheels. You may need to turn the system off to enable you to rock the vehicle in order to free it.

■ Turning off TRAC only



Quickly push and release the button to turn off TRAC.

The slip indicator light should come on.

Push the button again to turn the system back on.

■ Turning off both TRAC and VSC



Push and hold the button for more than 3 seconds while the vehicle is stopped to turn off TRAC and VSC.

The slip and VSC OFF indicator light should come on.

Push the button again to turn the system back on.

■ Automatic reactivation of TRAC and VSC

Turning the “ENGINE START STOP” switch OFF after turning off the TRAC and VSC systems will automatically re-enable them.

■ Automatic TRAC reactivation

If only the TRAC system is turned off, the TRAC system will turn on when the vehicle speed increases.

■ Automatic TRAC and VSC reactivation

If the TRAC and VSC systems are turned off, the systems will not turn on even when the vehicle speed increases.

■ Sounds and vibrations caused by the ABS, brake assist, VSC, TRAC, hill-start assist control and VGRS (GS460) systems

- A sound may be heard from the engine compartment when the engine is started or just after the vehicle begins to move. This sound does not indicate that a malfunction has occurred in any of these systems.
- Any of the following conditions may occur when the above systems are operating. None of these indicates that a malfunction has occurred.
 - Vibrations may be felt through the vehicle body and steering.
 - A motor sound may be heard after the vehicle comes to a stop.
 - The brake pedal may pulsate slightly after the ABS is activated.
 - The brake pedal may move down slightly after the ABS is activated.

■ Hill-start assist control operating conditions

This system comes into operation under the following conditions after the brake pedal has been depressed and the vehicle has come to a stop:

- The shift lever is in the “D” or “S”.
- The system has detected that the vehicle is moving backwards.
- GS350: The brake pedal is not depressed.

■ Reduced effectiveness of EPS

The effectiveness of EPS is reduced to prevent the system from overheating when there is frequent steering input over an extended period of time. The steering wheel may feel heavy as a result. Should this occur, refrain from excessive steering input or stop the vehicle and turn the engine off. The system should return to normal about 10 minutes.

■ GS460: VGRS is disabled in the following situations

- During stopping or the steering wheel has been moved for a long time while driving at lower speeds.
- After the engine is restarted at less than -22°F (-30°C).

⚠ CAUTION

Any of the following conditions may result in an accident which could cause death or serious injury:

■ The ABS does not operate effectively when

- The limits of tire gripping performance have been exceeded.
- The vehicle hydroplanes while driving at high speed on the wet or slick road.

■ Stopping distance when the ABS is operating will exceed that of normal conditions

The ABS is not designed to shorten the vehicle's stopping distance. Always maintain a safe distance from the vehicle in front of you in the following situations.

- When driving on dirt, gravel or snow-covered roads
- When driving with tire chains
- When driving over bumps in the road
- When driving over roads with potholes or roads with uneven roads

■ TRAC may not operate effectively when

Directional control and power may not be achievable while driving on slippery road surfaces, even if the TRAC is operating.

Do not drive the vehicle in conditions where stability and power may be lost.

 **CAUTION**
■ The hill-start assist control may not operate effectively when

- On steep inclines.
- On icy surfaces.

■ When the VSC is activated

The slip indicator light flashes and a warning buzzer sounds. Always drive carefully. Reckless driving may cause an accident. Exercise particular care when the indicator light flashes and a buzzer sounds.

■ When TRAC and VSC are off

Be especially careful and drive at a speed appropriate to the road conditions. As these are systems to ensure vehicle stability and driving force, do not turn off TRAC and VSC unless necessary.

■ Replacing tires

Make sure that all tires are of the same size, brand, tread pattern and total load capacity. In addition, make sure that the tires are inflated to the specified tire pressure level.

The ABS and VSC will not function correctly if different tires are fitted on the vehicle.

Contact your Lexus dealer for further information when replacing tires or wheels.

■ Handling of tires and suspension

Using tires with any kind of problem or modifying the suspension will affect the driving assist systems, and may cause the system to malfunction.

2-4. Using other driving systems

PCS (Pre-Collision System) (if equipped)

Safety systems such as the brakes and seat belts are automatically engaged to lessen impact and injuries to occupants as well as vehicle damage when the radar sensor detects an unavoidable frontal collision.

■ Pre-collision seat belts (front seats only)

The seat belts are immediately retracted as the effect of the pretensioner is increased (→P. 54), to help prepare the driver and passengers. In the event of sudden braking or skidding, the system will operate even if no obstacle has been detected.

■ Pre-collision brake assist

Applies greater braking force in relation to how strongly the brake pedal is depressed.

■ Pre-collision AVS

If the system determines that the collision is unavoidable, the operation of AVS (→P. 183) helps prevent the vehicle front from going down when hard brakes are applied.

Radar sensor

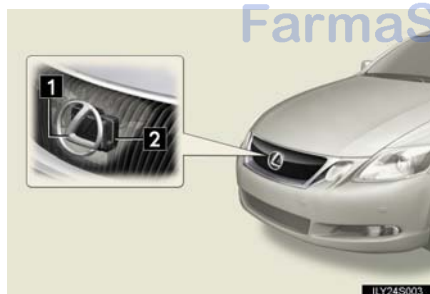

Detects vehicles or other obstacles on or near the road ahead and determines whether a collision is imminent based on the position, speed, and heading of the obstacles.

- 1 Grille cover
- 2 Radar sensor

■ Obstacles not detected

The sensor cannot detect plastic obstacles such as pylons. There may also be occasions when the radar sensor cannot detect pedestrians, animals, bicycles, motorcycles, trees, or snowdrifts.

■ The pre-collision system is operational when

- Seat belts (linked to the radar sensor)
 - Vehicle speed is above 3 mph (5 km/h).
 - The speed at which your vehicle is approaching the obstacle or oncoming vehicle exceeds 18 mph (30 km/h).
 - The front occupants are wearing a seat belt.
- Seat belts (linked to brake operation)
 - Vehicle speed exceeds 18 mph (30 km/h).
 - The system detects sudden braking or skidding.
 - The front occupants are wearing a seat belt.
- Brake assist
 - Vehicle speed is above 18 mph (30 km/h).
 - The speed at which your vehicle is approaching the obstacle or oncoming vehicle exceeds 18 mph (30 km/h).
 - The brake pedal is depressed.
- AVS
 - Vehicle speed is above 3 mph (5 km/h).
 - The speed at which your vehicle is approaching the obstacle or oncoming vehicle exceeds 18 mph (30 km/h).

■ Conditions that may trigger the system even if there is no danger of collision

- When there is an object by the roadside at the entrance to a curve
- When passing an oncoming vehicle on a curve
- When driving over a narrow iron bridge
- When there is a metal object on the road surface
- When driving on an uneven road surface
- When passing an oncoming vehicle on a left-turn
- When your vehicle rapidly closes on the vehicle in front

When the system is activated in the situations described above there is also a possibility that the seat belts will retract quickly and the brakes will be applied with a force greater than normal. When the seat belt is locked in the retracted position, stop the vehicle in a safe place, release the seat belt and refasten.

■ When there is a malfunction in the system

Warning lights and/or warning messages will turn on or flash. (→P. 489, 499)

تلفن شبانه روزی: ۰۲۱-۸۸۶۲۰۸۵

FarmaSOS.com

⚠ CAUTION**■ Handling the radar sensor**

Observe the following to ensure the pre-collision system can function effectively.

- Keep the sensor and front grille clean at all times.
Clean the sensor and front grille with a soft cloth so you do not mark or damage them.
- Do not subject the sensor or surrounding area to a strong impact.
If the sensor moves even slightly off position, the system may malfunction. If the sensor or surrounding area are subject to a strong impact, always have the area inspected and adjusted by a Lexus dealer.
- Do not disassemble the sensor.
- Do not attach accessories or stickers to the sensor, grille cover or surrounding area.
- Do not modify or paint the sensor and grille.

■ Limitations of the pre-collision system

Do not rely on the pre-collision system. Always drive safely, taking care to observe your surroundings and checking for any obstacles or other road hazards.

2-5. Driving information

Cargo and luggage

Take notice of the following information about storage precautions, cargo capacity and load.

- Stow cargo and luggage in the trunk whenever possible. Be sure all items are secured in place.
- Be careful to keep the vehicle level. Placing the weight as far forward as possible helps maintain vehicle balance.
- For better fuel economy, do not carry unnecessary weight.

Capacity and distribution

Cargo capacity depends on the total weight of the occupants.

$(\text{Cargo capacity}) = (\text{Total load capacity}) - (\text{Total weight of occupants})$

Steps for Determining Correct Load Limit—

- (1) Locate the statement “The combined weight of occupants and cargo should never exceed XXX kg or XXX lbs.” on your vehicle’s placard.
- (2) Determine the combined weight of the driver and passengers that will be riding in your vehicle.
- (3) Subtract the combined weight of the driver and passengers from XXX kg or XXX lbs.

- (4) The resulting figure equals the available amount of cargo and luggage load capacity.

For example, if the "XXX" amount equals 1400 lbs. and there will be five 150 lb passengers in your vehicle, the amount of available cargo and luggage load capacity is 650 lbs. ($1400 - 750 (5 \times 150) = 650$ lbs.)

- (5) Determine the combined weight of luggage and cargo being loaded on the vehicle.

That weight may not safely exceed the available cargo and luggage load capacity calculated in Step 4.

- (6) If your vehicle will be towing a trailer, load from your trailer will be transferred to your vehicle. Consult this manual to determine how this reduces the available cargo and luggage load capacity of your vehicle. (→P. 198)

Lexus does not recommend towing a trailer with your vehicle. Your vehicle is not designed for trailer towing.

تلفن شبانه روزی: +۸۵-۸۸۶۲۰۲۶

FarmaSOS.com

Example on your vehicle

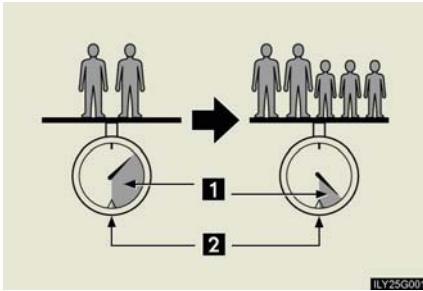

- 1 Cargo capacity
- 2 Total load capacity

When 2 people with the combined weight of 366 lb. (166 kg) are riding in your vehicle, which has a total load capacity of 815 lb. (370 kg), the available amount of cargo and luggage load capacity will be as follows:

$$815 \text{ lb.} - 366 \text{ lb.} = 449 \text{ lb.} \quad (370 \text{ kg} - 166 \text{ kg} = 204 \text{ kg})$$

In this condition, if 3 more passengers with the combined weight of 388 lb. (176 kg) get on, the available cargo and luggage load will be reduced as follows:

$$449 \text{ lb.} - 388 \text{ lb.} = 61 \text{ lb.} \quad (204 \text{ kg} - 176 \text{ kg} = 28 \text{ kg})$$

As shown in the above example, if the number of occupants increases, the cargo and luggage load equaling the combined weight of the occupants who got on later, by an amount. In other words, if an increase in the number of occupants causes an excess of the total load capacity (combined weight of occupants plus cargo and luggage load), you must reduce the cargo and luggage on your vehicle.

 **CAUTION**
■ Things that must not be carried in the trunk

The following things may cause a fire if loaded in the trunk.

- Receptacles containing gasoline
- Aerosol cans

■ Storage precautions

- Do not place anything on the package tray behind the rear seatback. Such items may be thrown about and possibly injure people in the vehicle during sudden braking or in an accident.
- Do not drive with objects on top of the instrument panel. They may interfere with the driver's field of view or move during sharp acceleration or turning, thus impairing the driver's control of the vehicle. In an accident they may injure the vehicle occupants.
- Secure all items in the occupant compartment, as they may shift and injure someone during an accident or sudden braking.

■ Weight of the load

- Improper loading may cause deterioration of steering or braking control resulting in an accident which may cause death or serious injury.
- Do not exceed the maximum axle weight rating or the total vehicle weight rating.
- Even if the total load of occupant's weight and the cargo load is less than the total load capacity, do not apply the load unevenly. Improper loading may cause deterioration of steering or braking control which may cause death or serious injury.

2-5. Driving information

Vehicle load limits

Vehicle load limits include total load capacity, seating capacity, towing capacity and cargo capacity.

■ Total load capacity: 815 lb. (370 kg)

Total load capacity means the combined weight of occupants, cargo and luggage.

■ Seating capacity: 5 occupants (Front 2, Rear 3)

Seating capacity means the maximum number of occupants whose estimated average weight is 150 lb. (68 kg) per person.

Even if the number of occupants are within the seating capacity, do not exceed the total load capacity.

■ Towing capacity

Lexus does not recommend towing a trailer with your vehicle.

■ Cargo capacity

Cargo capacity may increase or decrease depending on the weight and the number of occupants.

■ Total load capacity and seating capacity

These details are also described on the tire and loading information label. (→P. 431)

CAUTION

■ Overloading the vehicle

Do not overload the vehicle.

It may not only cause damage to the tires, but also degrade steering and braking ability, resulting in an accident.

Winter driving tips

Carry out the necessary preparations and inspections before driving the vehicle in winter. Always drive the vehicle in a manner appropriate to the prevailing weather conditions.

■ Pre-winter preparations

- Use fluids that are appropriate to the prevailing outside temperatures.
 - Engine oil
 - Engine coolant
 - Washer fluid
- Have a service technician inspect the level and specific gravity of battery electrolyte.
- Have the vehicle fitted with four snow tires or purchase a set of tire chains for the rear tires.

Ensure that all tires are the same size and brand, and that chains match the size of the tires.

■ Before driving the vehicle

Perform the following according to the driving conditions.

- Do not try to forcibly open a window or move a wiper that is frozen. Pour warm water over the frozen area to melt the ice. Wipe away the water immediately to prevent it from freezing.
- To ensure proper operation of the climate control system fan, remove any snow that has accumulated on the air inlet vents in front of the windshield.
- Remove any ice that has accumulated on the vehicle chassis.
- Periodically check for and remove any excess ice or snow that may have accumulated in the wheel well or on the brakes.

■ **When driving the vehicle**

Accelerate the vehicle slowly and drive at a reduced speed suitable to road conditions.

■ **When parking the vehicle**

Park the vehicle and move the shift lever to "P" without setting the parking brake. The parking brake may freeze up, preventing it from being released.

Regulations on the use of snow chains

- Regulations regarding the use of tire chains vary according to location and type of road. Always check local regulations before installing chains.
- Use SAE Class "S" type radial tire chains, with the exception of radial cable chains or V-bar type chains.
 - Install the chains on the rear tires.
 - Refer to the explanation that comes with the tire chains for installation instructions.
- Retighten the chains after driving 1/4 - 1/2 mile (0.5 - 1.0 km).

Shifting the windshield wiper position

You can shift the wipers to the rest position manually. (In heavy snow or icy condition etc.)

Grip the hook section of the wiper arm firmly when shifting the wiper position.

► To rest position

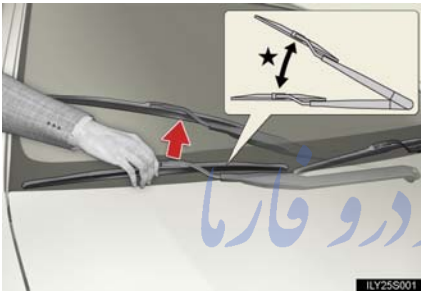

Raise the wiper in line with the windshield.

You can stand the wipers up for the rest position.

*: More than 3.9 in. (10 cm)

► To retract position



Lower the wipers by pressing on the upper part of the hook section.

تلفن شبانه روزی: ۰۲۱-۸۸۶۲۰۸۵

FarmaSOS.com

■ Snow chain installation

Observe the following precautions when installing and removing chains.

- Install and remove tire chains in a safe location.
- Install tire chains on the rear tires only. Do not install tire chains on front tires.
- Install tire chains following the instructions provided in the accompanying instructions.

⚠ CAUTION

■ Driving with snow tires

Observe the following precautions to reduce the risk of accidents.

Failing to do so may result in a loss of vehicle control and cause death or serious injury.

- Use tires of the size specified for your vehicle.
- Maintain the specified level of tire inflation pressure.
- Do not drive in excess of 75 mph (120 km/h), regardless of the type of snow tires being used.
- Use snow tires on all, not just some wheels.

■ Driving with snow chains

Observe the following precautions to reduce the risk of accidents.

Failing to do so may result in the vehicle being unable to be driven safely, and may cause death or serious injury.

- Do not drive in excess of the speed limit specified for the tire chains being used, or 30 mph (50 km/h), whichever is lower.
- Avoid driving on bumpy road surfaces or over potholes.
- Avoid sudden turns and braking, as use of chains may adversely affect vehicle handling.
- Slow down sufficiently before entering a curve to ensure that vehicle control is maintained.

 NOTICE

■ **Repairing or replacing snow tires**

Request repairs of and obtain replacement snow tires from Lexus dealers or legitimate tire retailers.

This is because the removal and attachment of snow tires affects the operation of the tire pressure warning valves and transmitters.

■ **Fitting tire chains**

The tire pressure warning valves and transmitters may not function correctly when tire chains are fitted.

امداد خودرو فارما

تلفن شبانه روزی: ۰۲۱-۸۸۶۲۰۸۵

FarmaSOS.com

2-5. Driving information

Trailer towing

Lexus does not recommend towing a trailer with your vehicle. Lexus also does not recommend the installation of a tow hitch or the use of a tow hitch carrier for a wheelchair, scooter, bicycle, etc. Your Lexus is not designed for trailer towing or for the use of tow hitch mounted carriers.



ILV25G002

امداد خودرو فارما

تلفن شبانه روزی: ۰۲۱-۸۸۶۲۰۸۵

FarmaSOS.com

2-5. Driving information

Dinghy towing

Your vehicle is not designed to be dinghy towed (with 4 wheels on the ground) behind a motor home.

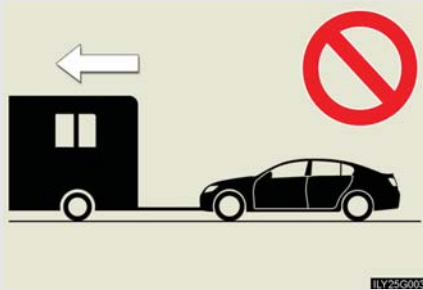

 NOTICE

■ To avoid serious damage to your vehicle

Do not tow your vehicle with 4 wheels on the ground.

تلفن شبانه روزی: ۰۲۱-۸۸۶۲۰۸۵

FarmaSOS.com

3-1. Using the touch screen	208
Touch screen	208
Setting the touch screen	212
3-2. Using the air conditioning system and defogger.....	217
Automatic air conditioning system.....	217
Rear window and outside rear view mirror defoggers.....	225

تلفن شبکه روزی: ۰۲۱-۸۸۶۲۰۸۵

FarmaSOS.com

- 3-3. Using the audio system** 226
- Audio system type..... 226
 - Using the radio..... 229
 - Using the cassette player ... 238
 - Using the CD player 242
 - Playing MP3 and WMA discs..... 247
 - Using the DVD player..... 251
 - Playing DVD video/audio..... 254
 - Playing video CD 266
 - DVD player and DVD video disc information 270
 - Optimal use of the audio/video system..... 282
 - Using the AUX adapter 287
 - Using the steering switches..... 288
- 3-4. Using the hands-free system (for cellular phone)**..... 291
- Hands-free system (for cellular phone) 291
 - Using the Bluetooth[®] phone 296
 - Setting the hands-free system 311
- 3-5. Using the interior lights** 337
- Interior lights list 337
- 3-6. Using the storage features** 340
- List of storage features..... 340
- 3-7. Other interior features** 347
- Sun visors 347
 - Vanity mirror 348
 - Clock..... 349
 - Outside temperature display..... 350
 - Ashtrays..... 351
 - Cigarette lighter 352
 - Power outlet 353
 - Seat heaters/ventilators..... 354
 - Armrest 356
 - Rear sunshade 357
 - Floor mats 359
 - Trunk features..... 360
 - Garage door opener 363
 - Compass 369
 - Lexus Link System 373

3-1. Using the touch screen

Touch screen

By touching the screen with your finger, you can control the audio system and air conditioning, adjust the screen display etc.

► With navigation system



► Without navigation system

تلفن شبانه روزی: ۰۲۱-۸۸۶۲۰۸۵



The "Information" screen shown in the above illustration is displayed when  is pressed.

Switches	Page
"CLIMATE"	P. 217
"AUDIO"	P. 226
"INFO" (Displaying the "Information" screen)	P. 208
"DISP" (Adjusting the display)	P. 213
Trip Information (Displaying the "Trip Information" screen)	P. 210
Maintenance	Navigation System Owner's Manual
Telephone	P. 296
Calendar	Navigation System Owner's Manual
"LEXUS Park Assist"	P. 173
Language	P. 212
Screen Setting	P. 215
Beep Off	P. 212
Adjust Clock	P. 349/ Navigation System Owner's Manual

The initial screen



If the “ENGINE START STOP” switch is set to ACCESSORY or IGNITION ON mode, the initializing screen will be displayed for a few seconds as the system starts up.

Trip information

Trip information such as driving distance, average vehicle speed, fuel consumption, etc. can be displayed on the screen. The displayed figure is for general information and may not always reflect precise and actual conditions.

■ Displaying the screen

STEP 1 Press .

STEP 2 Touch  on the “Information” screen.

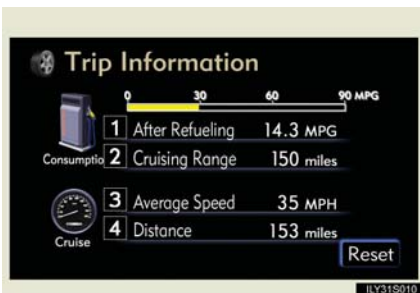

- 1 Average fuel consumption
- 2 Cruising range
- 3 Average vehicle speed
- 4 Total distance

■ Resetting the data

Touching  will reset the "Average Speed" and "Distance".

■ To avoid damaging the touch screen

- Touch the screen lightly with your finger. If there is no response, remove your finger from the screen and try again.
- Remove any dirt on the screen by wiping with a soft cloth. Do not use detergent.

■ When using the touch screen

- If the screen is cold, the display may be dark, or the system may seem to be operating slightly slower than normal.
- The screen may seem dark and hard to see when viewed through sunglasses. Change your angle of viewing, adjust the display on the "Display" screen or remove your sunglasses.

امداد خودرو فارما

تلفن شبانه روزی: ۰۲۱-۸۸۶۲۰۸۵

FarmaSOS.com

3-1. Using the touch screen

Setting the touch screen

You can change the touch screen to your desired settings.

Language settings

The language used for all voice guidance, messages and touch screen switches may be changed.

STEP 1 Press .

STEP 2 Touch  on the "Information" screen.

STEP 3 Select the desired language.



STEP 4 Touch .

Turning off the beep sound

The beep that sounds when a touch screen button is touched can be turned off.

STEP 1 Press .

STEP 2 Touch .



Adjusting the display

STEP 1 Press **DISP.**

STEP 2 Adjust the display as desired using **R / -** and **G / +**.

If you do not touch the screen for 20 seconds, the system will return to the previous screen.

► With CD player



► With DVD player



	R / -	G / +
Color	Red	Green
Tone	Lighter	Darker
Contrast	Weaker	Stronger
Brightness	Darker	Brighter

تلفن شبانه روزی: ۰۲۱-۸۸۶۲۰۸۵

FarmaSOS.com

■ “Day Mode”



When the headlights are turned on, the screen dims. However the screen can be switched to “Day Mode”.

The screen will stay in “Day Mode” when the headlights are turned on until  is touched again.

If the instrument panel light control is set to “MAX”, “Day Mode” is not displayed.

■ To turn off the picture display

If  is touched, the screen display is turned off, and guidance is by voice only.

امداد خودرو فارما

تلفن شبانه روزی: ۰۲۱-۸۸۶۲۰۸۵

FarmaSOS.com

Screen settings

STEP 1 Press .

STEP 2 Touch  on the "Information" screen.

The following screen settings can be changed.

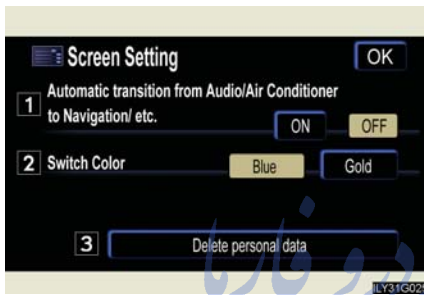

1 Automatic transition

20 seconds after air conditioning or audio system use, the system will return the display to the previous screen.

2 Switch color

You can select the switch color.

3 Delete personal data

The following personal data is deleted:

- User selection settings
- Phone book data
- Dialed numbers and received calls
- Speed dial
- Bluetooth® phone data
- Security code
- Maintenance conditions*
- Maintenance information off setting*
- Memory points*
- Areas to avoid*
- Previous points*
- Route trace*

*: If the navigation system is equipped

تلفن شبانه روزی: ۰۲۱-۸۸۶۲۰۸۵

FarmaSOS.com

■ Setting automatic transition

STEP 1 Touch **ON** or **OFF** .

STEP 2 Press **OK** .

■ Setting the switch color

STEP 1 Touch **Blue** or **Gold** .

STEP 2 Press **OK** .

■ To delete personal data

STEP 1 Touch **Delete personal data** .

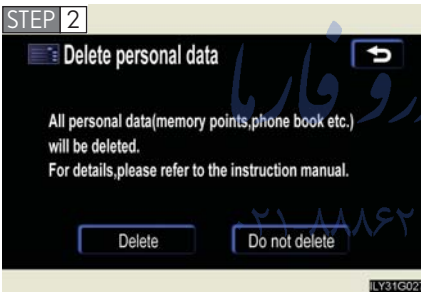

Touch **Delete** .

Check carefully beforehand, as data cannot be retrieved once initialized.

FarmaSOS.com

■ When deleting personal data

Data can only be deleted when the vehicle is stopped.

■ When selling the vehicle

Be sure to initialize both the call history and personal data. (→P. 215)

■ If you touch

The display returns to the previous screen.

3-2. Using the air conditioning system and defogger

Automatic air conditioning system

Airflow and outlets are automatically adjusted according to the temperature setting.

Press  to display the air conditioning operation screen.



The above illustration is for a vehicle equipped with the navigation system. The position of  is slightly different for vehicles not equipped with the navigation system.

Using the automatic mode

STEP 1 Press .

➔ The air conditioning system will begin to operate. Air outlets and fan speed are automatically adjusted according to the temperature setting.

STEP 2 Press  to switch to automatic mode.

➔ Automatically switches between outside air and recirculated air modes.

STEP 3 Press \wedge to increase the temperature and \vee to decrease the temperature on .

The temperature for the driver and passenger seats can be set separately.

Adjusting the settings

■ Adjusting the temperature setting

Press \wedge to increase the temperature and \vee to decrease the temperature on



Press \wedge (increase) or \vee (decrease) on  to separately adjust the temperature for the passenger and driver sides (dual mode). Touch **DUAL** to return the driver and passenger side temperatures to the same setting (simultaneous mode).

The air conditioning system switches between dual and simultaneous modes each time **DUAL** is touched.

■ Adjusting the fan speed

Touch any switch of  (decrease ↔ increase) on the operating screen.

Press  to turn the fan off.

■ Changing the air outlets

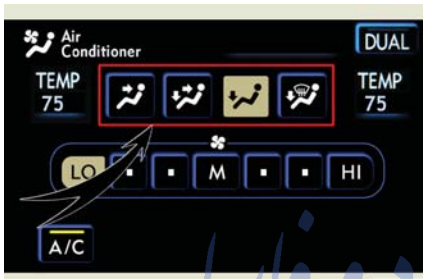

Touch any mode on the operating screen.

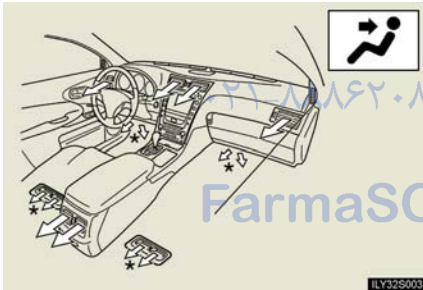

Air flows to the upper body.

*: Only in the automatic mode

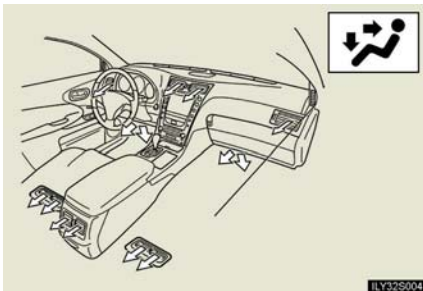

Air flows to the upper body and feet.

3-2. Using the air conditioning system and defogger

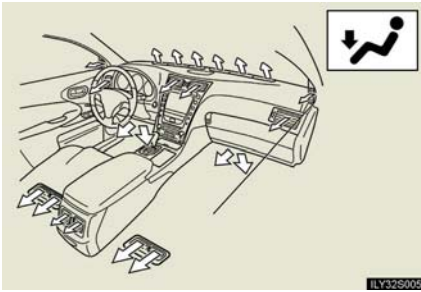

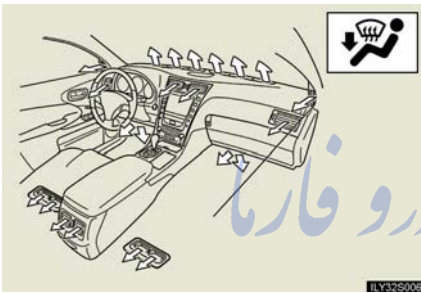

Air flows to the feet.



Air flows to the feet and the windshield defogger operates.

■ Switching between outside air and recirculated air modes

Press  .

The mode switches between  (recycles air inside the vehicle), "AUTO" and  (introduces air from outside the vehicle) modes each time the button is pressed.

When the system is switched to automatic mode, the air conditioning system operates automatically.

Defogging the windshield



Press .

The air conditioning system control operates automatically.

Micro dust and pollen filter



Press .

Outside air mode switches to  (recirculated air) mode. Pollen is removed from the air and the air flows to the upper part of the body.

Usually the system will turn OFF automatically approximately 3 minutes later.

To stop the operation, press  again.

Adjusting the sensitivity of the air intake control in automatic mode

STEP 1 Press  until the smog sensor screen appears while the vehicle is stopped.

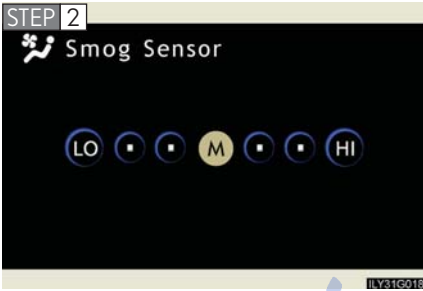

Touch any switch of  (lower sensitivity ↔ higher sensitivity) on the operating screen.

Adjusting the position of and opening and closing the air outlets

► Front outlets

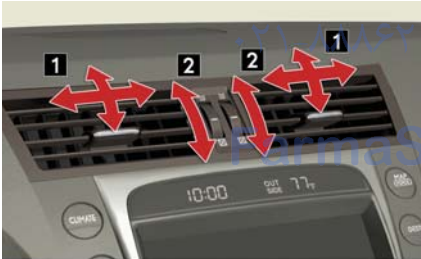

1 Direct air flow to the left or right, up or down

2 Turn the knob to open or close the vent

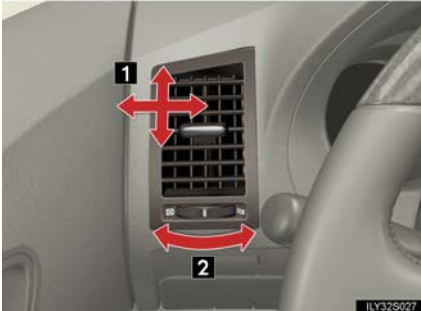

► Rear seat outlets

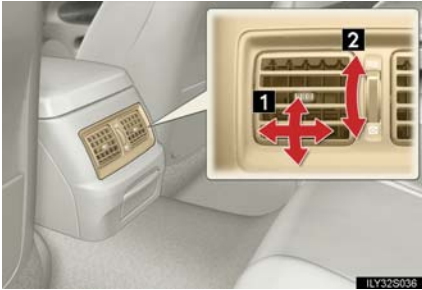

- 1 Direct air flow to the left or right, up or down
- 2 Turn the knob to open or close the vent

■ Using the automatic mode

Fan speed is adjusted automatically in accordance with the temperature setting and ambient conditions. As a result, the following may occur.

- The system may switch automatically to recirculated mode when the coolest temperature setting is selected in summer.
- Immediately after the switch is pressed, the fan may stop for a while until warm or cool air is ready to flow.
- Cool air may flow to the area around the upper body when the heater is on.

■ Using the system in recirculated air mode

The windows will fog up more easily if the recirculated air mode is used for an extended period.

■ Window defogger feature

Recirculated air mode may automatically switch to  (outside air) mode in situations where the windows need to be defogged.

■ Outside temperature approaches 32°F (0°C)

The air conditioning system may not operate even when  is touched.

■ Automatic mode for air intake control

In automatic mode, the system detects exhaust gas and other pollutants and automatically switches between outside air and recirculated air modes.

When the air conditioning is off, and the fan is operating, turning the auto mode ON will activate the air conditioning system.

■ Micro dust and pollen filter

● In order to prevent the windows from fogging up when the outside air is cold, the following may occur.

- Outside air mode does not switch to .
- The air conditioning system operates automatically.
- The operation cancels after 1 minute.

● In rainy weather, the windows may fog up. Press .

■ When the indicator light on flashes

Touch  and turn off the air conditioning system before turning it on once more. There may be a problem in the air conditioning system if the indicator light continues to flash. Turn the air conditioning system off and have it inspected by your Lexus dealer.

CAUTION

■ To prevent the windshield from fogging up

Do not use  during cool air operation in extremely humid weather. The difference between the temperature of the outside air and that of the windshield can cause the outer surface of the windshield to fog up, blocking your vision.

NOTICE

■ To prevent 12 volt battery discharge

Do not leave the automatic air conditioning system on longer than necessary when the engine is off.

3-2. Using the air conditioning system and defogger

Rear window and outside rear view mirror defoggers

These features are used to defog the rear window, and to remove rain-drops, dew and frost from the outside rear view mirrors.



Press the button.

Press the button to turn on the rear window and outside rear view mirror defoggers. The defoggers will automatically turn off after approximately 15 minutes. Pressing the button again also turns the defoggers off.

■ Operating conditions

The "ENGINE START STOP" switch must be in the IGNITION ON mode.

⚠ CAUTION

■ When the outside rear view mirror defoggers are on

Do not touch the rear view mirror surfaces, as they can become very hot and burn you.

⚠ NOTICE

■ To prevent 12 volt battery discharge

Turn the defoggers off when the engine is off.

3-3. Using the audio system

Audio system type

CD and (optional) DVD player with changer, cassette player, and AM/FM radio

This illustration below is for a vehicle equipped with the DVD player.



The audio system appearance and screen may differ slightly for vehicles not equipped with the DVD player. In addition, the position of  is slightly different for vehicles not equipped with the navigation system.

CD player: Plays audio CDs, CD text, MP3 discs and WMA discs.

DVD player: Plays audio CDs, CD text, video CDs, MP3 discs, WMA discs, DVD video discs and DVD audio discs.

Title	Page
Using the radio	P. 229
Using the cassette player	P. 238
Using the CD player	P. 242
Playing MP3 and WMA discs	P. 247
Using the DVD player	P. 251
Playing DVD video/audio	P. 254
Playing video CD	P. 266
DVD player and DVD video disc information	P. 270
Optimal use of the audio/video system	P. 282
Using the AUX adapter	P. 287
Using the steering switches	P. 288

■ Using cellular phones

Interference may be heard through the audio system's speakers if a cellular phone is being used inside or close to the vehicle while the audio system is operating.

 CAUTION

■ **For vehicles sold in the U.S.A. and Canada**

● Part 15 of the FCC Rules

FCC Warning:

Any unauthorized changes or modifications to this equipment will void the user's authority to operate this device.

● Laser products

- Do not take this unit apart or attempt to make any changes yourself. This is an intricate unit that uses a laser pickup to retrieve information from the surface of compact discs. The laser is carefully shielded so that its rays remain inside the cabinet. Therefore, never try to disassemble the player or alter any of its parts since you may be exposed to laser rays and dangerous voltages.
- This product utilizes a laser. Use of controls or adjustments or performance of procedures other than those specified herein may result in hazardous radiation exposure.

 NOTICE

تلفن شبانه روزی: ۰۲۱-۸۸۶۲۰۸۵

■ **To prevent 12 volt battery discharge**

Do not leave the audio system on longer than necessary with the engine off.

■ **To avoid damaging the audio/video system**

Take care not to spill drinks or other fluids over the audio system.

3-3. Using the audio system

Using the radio

Press **AM/SAT** or **FM** to choose either an AM or FM band.

When you press **AUDIO** while listening to the radio, the following audio control screen appears.

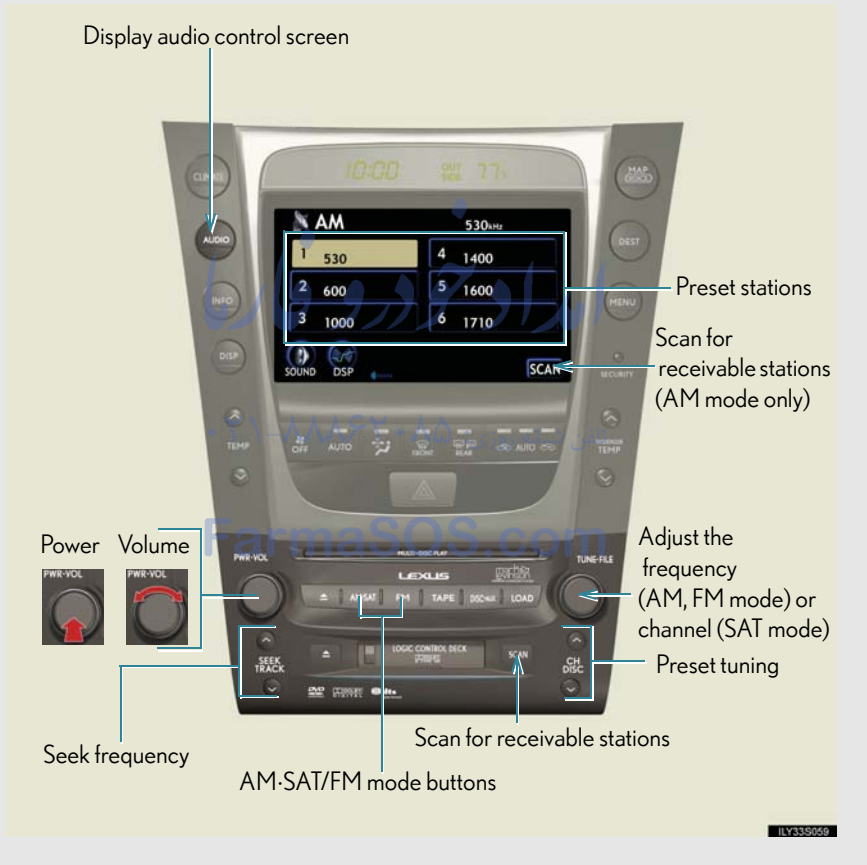

Setting station presets (excluding XM[®] Satellite Radio)

STEP 1 Search for desired stations by turning  or pressing

∧ or ∨ on





STEP 2 Touch and hold one of the preset stations (1 - 6) until you hear a beep.



Scanning radio stations (excluding XM[®] Satellite Radio)

■ Scanning the preset radio stations

● AM station

STEP 1 Touch  on the screen or press  until "P-SCAN" appears.

Preset stations will be played for a few seconds each.

STEP 2 When the desired station is reached, touch  or press  once again.

● FM station

STEP 1 Press  until "P-SCAN" appears.

STEP 2 When the desired station is reached, press the button once again.

■ Scanning all radio stations within range

● AM station

STEP 1 Touch **SCAN** on the screen or press **SCAN**.

“SCAN” appears on the screen and all stations with reception will be played for a few seconds each.

STEP 2 When the desired station is reached, touch **SCAN** or press **SCAN** once again.

● FM station

STEP 1 Press **SCAN**.

“SCAN” appears on the screen and all stations with reception will be played for a few seconds each.

STEP 2 When the desired station is reached, press the button once again.

RDS (Radio Data System)

This feature allows your radio to receive station identification information and program information (classical, jazz, etc.) from radio stations which broadcast this information.

■ Receiving RDS broadcasts

STEP 1



Touch **TYPE** or **TYPE** on the screen.

The type of program changes each time the button is pressed.

- ROCK
- EASYLIS (Easy listening)
- CLS/JAZZ (Classical music and Jazz)
- R & B (Rhythm and Blues)
- INFORM (Information)
- RELIGION
- MISC (Miscellaneous)
- ALARM (Emergency messages)

If the system receives no RDS stations, "NO PTY" appears on the display.
When a program is set, "TYPE SEEK" appears.

STEP 2 Touch **TYPE SEEK** on the screen or press \wedge or \vee on **SEEK TRACK**.

The radio seeks or scans the station by the relevant program type.

If no radio station of that type is found, "NOTHING" appears on the screen.

■ Displaying radio text messages



Touch **MSG** on the screen.

If "MSG" appears on the screen, a text message may be displayed.

■ Traffic announcement

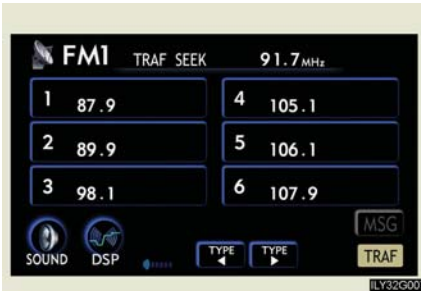

Touch **TRAF** on the screen.

“TRAF SEEK” appears on the display, and the radio will start seeking any station broadcasting traffic program information.

If no traffic program station is found, “NOTHING” appears on the display.

XM[®] Satellite Radio (if equipped)

■ Receiving XM[®] Satellite Radio



Press **AM-SAT** until “SAT” appears on the screen.

The display changes as follows each time the switch is pressed.

AM → SAT1 → SAT2 → SAT3

STEP 2 Turn  to select a desired channel from all the categories or

press \wedge or \vee on  to select a desired channel in the current category.

■ Presetting XM[®] Satellite Radio channels

Select the desired channel. Touch one of the preset stations (1 - 6) and hold it until you hear a beep.

■ Changing the channel category

Touch **TYPE** or **TYPE** on the screen.

■ Scanning XM[®] Satellite Radio channels

● Scanning channels in the current category

STEP 1 Touch **TYPE SCAN** on the screen or press **SCAN**.
“SCAN” appears on the screen.

STEP 2 When the desired channel is reached, touch **TYPE SCAN** or press the button once again.

● Scanning preset channels

STEP 1 Touch **TYPE SCAN** on the screen or press **SCAN** and hold it until you hear a beep.
“P-SCAN” appears on the screen.

STEP 2 When the desired channel is reached, touch **TYPE SCAN** or press the button once again.

■ Displaying the title and artist name

Touch **TEXT** on the screen.

The screen will display up to 16 characters.

Touch the button once again to return to the previous screen.



■ When the 12 volt battery is disconnected

All preset stations are erased.

■ Reception sensitivity

- Maintaining perfect radio reception at all times is difficult due to the continually changing position of the antenna, differences in signal strength and surrounding objects, such as trains, transmitters, etc.
- The radio antenna is mounted inside the rear window. To maintain clear radio reception, do not attach metallic window tinting or other metallic objects to the antenna wire mounted inside the rear window.

■ Receiving XM[®] Satellite Radio

The optional Lexus genuine satellite radio tuner and antenna allows you to receive and play XM[®] Satellite Radio broadcasts. (Subscription is required. Not available in Hawaii and Alaska.)*

● XM[®] subscriptions

For detailed information about XM[®] Satellite Radio or to subscribe, visit XM[®] on the web at www.xmradio.com or call (800) 967-2346.

● Radio ID

You will need the radio ID when activating XM[®] service or reporting a prob-

lem. Select "CH000" using the  dial, and the receiver's 8-character ID number will appear.

● Satellite tuner

The tuner supports only Audio Services (Music and Talk) and the accompanying Text Information of XM[®] Satellite Radio.

*: Terms and services provided by XM[®] Satellite Radio are subject to change without notice.

■ **If the satellite radio does not operate normally**

If a problem occurs with the XM[®] tuner, a message will appear on the screen. Refer to the table below to identify the problem, and take the suggested corrective action.

ANTENNA	<p>The XM[®] antenna is not connected. Check whether the XM[®] antenna cable is attached securely.</p> <p>There is a short-circuit in the antenna or the surrounding antenna cable. See a Lexus certified dealer.</p>
UPDATING	<p>You have not subscribed to XM[®] Satellite Radio. The radio is being updated with the latest encryption code. Contact XM[®] Satellite Radio for subscription information. When a contract is canceled, you can choose "CH000" and all free-to-air channels.</p> <p>The premium channel you selected is not authorized. Wait for about 2 seconds until the radio returns to the previous channel or "CH001". If it does not change automatically, select another channel. If you want to listen to the premium channel, contact XM[®] Satellite Radio.</p>
NO SIGNAL	<p>The XM[®] signal is too weak at the current location. Wait until your vehicle reaches a location with a stronger signal.</p>
LOADING	<p>The unit is acquiring audio or program information. Wait until the unit has received the information.</p>
OFF AIR	<p>The channel you selected is not broadcasting any programming. Select another channel.</p>

---	There is no song/program title or artist name/feature associated with the channel at that time. No action needed.
---	The channel you selected is no longer available. Wait for about 2 seconds until the radio returns to the previous channel or "CH001". If it does not change automatically, select another channel.

Contact the XM[®] Listener Care Center at (800) 967-2346 during the following hours*.

Monday - Saturday: 6 a.m. - 2 a.m. Eastern Time

Sunday: 8 a.m. - 8 p.m. Eastern Time

*: Subject to change without notice.

■ Certifications for the radio tuner

This equipment has been tested and found to comply with the limits for a class B digital device, pursuant to Part 15 of the FCC Rules. These limits are designed to provide reasonable protection against harmful interference in a residential installation. This equipment generates, uses and can radiate radio frequency energy and, if not installed and used in accordance with the instructions, may cause harmful interference to radio communications. However, there is no guarantee that interference will not occur in a particular installation.

If this equipment does cause harmful interference to radio or television reception, which can be determined by turning the equipment off and on, the user is encouraged to try to correct the interference by trying one or more of the following:

- Reorienting or relocating the receiving antenna.
- Increasing the separation between the equipment and receiver.
- Connecting the equipment into an outlet on a circuit different from that to which the receiver is connected.
- Consulting the dealer or an experienced radio/TV technician for help.

3-3. Using the audio system

Using the cassette player

Insert a cassette tape or press **TAPE** with a tape inserted.

When you press **AUDIO** while listening to the tape, the following audio control screen appears.



Selecting a track

■ Skip a number of tracks at a time

STEP 1 Press \wedge on



STEP 2



Press \wedge until the number you want to skip appears.

9 tracks can be skipped at a time.

■ Rewind a number of tracks at a time

STEP 1 Press \vee on



STEP 2



Press \vee until the number you want to rewind appears.

9 tracks can be rewound at a time.

Note that the number includes the current track.



Using Dolby® Noise Reduction

Touch  on the screen.

Reduces the level of noise for tapes recorded with Dolby NR only.

Dolby noise reduction is manufactured under license from Dolby Laboratories Licensing Corporation. DOLBY and the double-D symbol  are registered trademarks of Dolby Laboratories.

■ Canceling noise reduction, skip play, repeat play, rewind and fast forward

To cancel ,  and : Touch the corresponding button on the screen.

To cancel  and : Touch the corresponding button on the screen or press .

■ Auto-reverse feature

After the cassette player reaches the end of a tape, it automatically reverses and begins to play the other side, regardless of whether the cassette was playing or fast forwarding.

■ When the cassette player does not operate correctly due to the cassette recording conditions

Forwarding to the beginning of a track, repeat, blank tape skip and fast-forward may not be possible in the following situations:

- The interval between tracks is less than 3 seconds (beginning of track and repeat playback) or less than 15 seconds (blank tape skip).
- When there is noise between 2 tracks.
- The beginning and end of subsequent tracks are not clearly defined.

■ Cleaning the cassette player

Cassette player components (heads, capstan, pinch rollers) should be cleaned at least once a month using a cleaning tape to remove dirt and dust that can easily build up.

■ Using long playing cassette tapes

Avoid using tapes with a length of more than 90 minutes, as the tape used is very thin and may become tangled in the cassette player.

NOTICE

■ Cassette tapes that cannot be used

Do not use a cassette tape if it has been damaged or tangled or if its label is peeling off. Such tapes may affect playing speed and may also get stuck in the player.

■ Cassette player precautions

- Store cassette tapes away from direct sunlight.
- Do not insert anything other than cassette tapes into the cassette player.
- Do not apply oil to the cassette player.

FarmaSOS.com

3-3. Using the audio system Using the CD player

Insert a CD or press **DISC-AUX** with a CD inserted.

When you press **AUDIO** while listening to a CD, the following audio control screen appears.

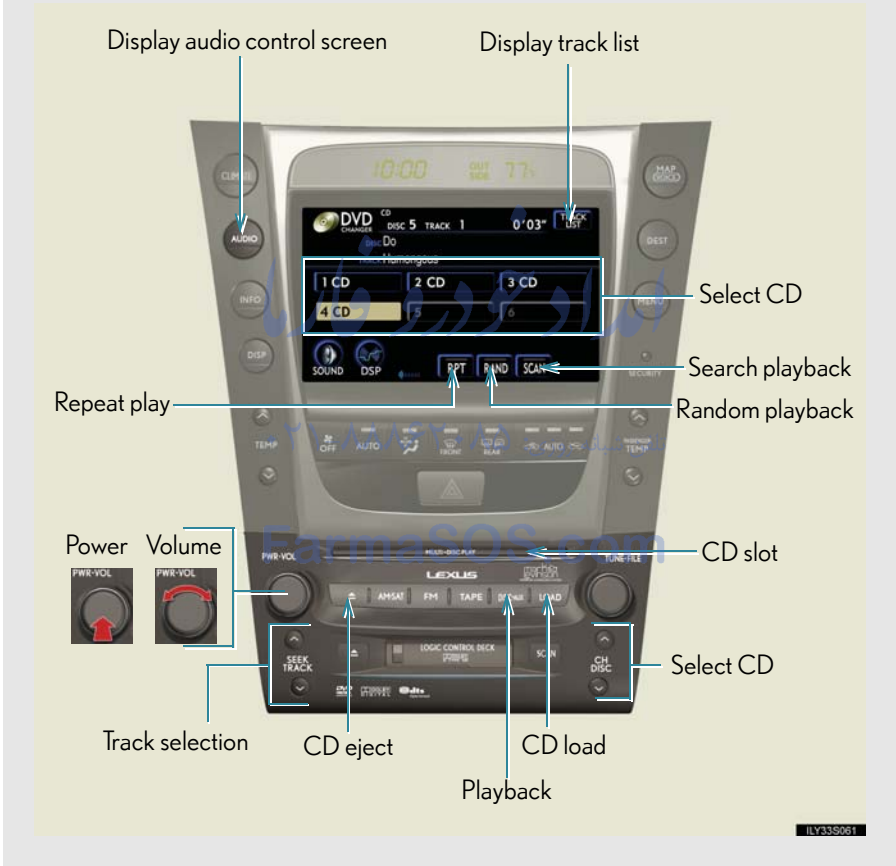

Loading a CD

■ Loading a single CD

STEP 1 Press .

STEP 2 When the indicator changes from flashing amber to green, insert a CD after the CD/DVD player door opens.

■ Loading multiple CDs

STEP 1 Press and hold  until you hear a beep.

STEP 2 When the indicator changes from flashing amber to green, insert a CD after the CD/DVD player door opens.

STEP 3 After inserting a CD, wait until the indicator changes from flashing amber to green, then insert the next CD after the CD/DVD door has opened.

Repeat steps 2 and 3 until you have inserted all CDs.

To cancel the operation, press the  or  button. If you do not insert a CD within 15 seconds, loading will be canceled automatically.

Ejecting CDs

■ Ejecting a CD

STEP 1 To select the CD to be ejected, touch the desired disc number

(1 - 6) on the screen or press \wedge or \vee on



STEP 2 Press  and remove the CD.

■ Ejecting all CDs

Press and hold  until you hear a beep, then remove the CDs.

Selecting, fast forwarding and scanning tracks

Selecting a track

Press \wedge to move up and \vee to move down using  until the desired track number appears on the screen.

To fast forward or rewind, press and hold \wedge or \vee on .



Selecting a track from the track list

STEP 1 Touch  on the screen.

STEP 2



Touch the desired track number.

 or : Changes the list by 6 track groups.

This function is available only when the vehicle is not moving.

Scanning a CD

STEP 1 Touch  on the screen.

“SCAN” appears on the screen.

The first 10 seconds of each track will be played.

STEP 2 Touch  once again when the desired track is reached.

Selecting a CD

■ To select a CD to play

Touch the desired disc number (1 - 6) on the screen or press \wedge or \vee on



■ To scan loaded CDs

STEP 1 Touch and hold **SCAN** on the screen until "D-SCAN" appears.

The first 10 seconds of the first track on each CD will be played.

STEP 2 Touch **SCAN** once again when the desired CD is reached.

Random playback

■ Current CD

Touch **RAND** on the screen.

Songs are played in random order until random playback is canceled.

■ All CDs

Touch and hold **RAND** on the screen until "D-RAND" appears.

Tracks on all loaded CDs are played in random order until the button is touched once again.

Repeating a track or a disc

■ Repeating a track

Touch **RPT** on the screen.

■ Repeating a disc

Touch and hold **RPT** on the screen until "D-RPT" appears.

■ Canceling random, repeat and scan playback

Touch **RAND**, **RPT**, or **SCAN** on the screen once again.

■ Displaying the title and artist name

If a CD-TEXT disc is inserted, the title of the disc and track will be displayed. Up to 16 letters can be displayed.

■ Error messages

→P. 270

امداد خودرو فارما

تلفن شبانه روزی: ۰۲۱-۸۸۸۶۲۰۸۵

FarmaSOS.com

3-3. Using the audio system

Playing MP3 and WMA discs

Insert an MP3 or WMA disc or press **DISC-AUX** with a disc inserted.

When you press **AUDIO** during playback of the disc, the following audio control screen appears.



Loading, ejecting and selecting MP3 and WMA discs

Refer to the section titled “Using the CD player” for details. (→P. 242)

Selecting a folder

■ Selecting a folder

Touch “FOLDER ▲” or “▼” on the screen to select the previous/next folder.

■ Selecting a folder from the folder list

STEP 1 Touch **FOLDER LIST** on the screen.



Touch the desired folder number.

▲ or ▼: Changes the list by 6 folder groups.

DETAIL: Displays the details of the file currently playing.

FILE: Displays the file list.

This function is available only when the vehicle is not moving.

■ Selecting the desired folder by cueing the first file of each folder

Touch and hold **SCAN** on the screen until “FLD·SCAN” appears. When the desired folder is reached, touch **SCAN** once again.

Selecting and scanning files

■ Selecting one file at a time

Turn  or press \wedge or \vee on  to select the desired file.

■ Selecting a file from the file list

STEP 1 Touch  on the screen to turn the folder list on.

STEP 2





Touch  on the folder list screen.

STEP 3



Touch the desired file number.

 or : Changes the list by 6 groups.

: Displays the folder list.

: Displays the details of the file currently playing.

This function is available only when the vehicle is not moving.

■ Selecting a desired file by cueing the files in the folder

Touch  on the screen.

When the desired file is reached, touch  once again.

File repeat

Touch **RPT** on the screen.

Folder repeat

Touch and hold **RPT** on the screen until the “FLD RPT” appears.

Random playback

■ To play files from a particular folder in random order

Touch **RAND** on the screen.

■ To play all the files on a disc in random order

Touch and hold **RAND** on the screen until the “FLD RAND” appears.

■ Canceling random, repeat and scan playback

Touch **RAND**, **RPT** or **SCAN** on the screen once again.

■ Error messages

→P. 270

FarmaSOS.com

Loading a discs

■ Loading a single disc

STEP 1 Push **LOAD**.

STEP 2 When the indicator changes from flashing amber to green, insert a disc after the DVD player door opens.

■ Loading multiple discs

STEP 1 Press and hold **LOAD** until you hear a beep.

STEP 2 When the indicator changes from flashing amber to green, insert a disc after the DVD player door opens.

STEP 3 After inserting a disc, wait until the indicator changes from flashing amber to green, then insert the next disc after the DVD player door has opened.

STEP 4 Repeat steps 2 and 3 until you have inserted all discs.

To cancel the operation, press the **LOAD** or **DISC/PAUSE** button. If you do not insert a disc within 15 seconds, loading will be canceled automatically.

■ DVD hint screen





This screen appears when a DVD video, DVD audio or video CD is first selected with the “ENGINE START STOP” switch in ACCESSORY or IGNITION ON mode.

Touch **OK** once you have read the message.

Ejecting discs

Ejecting a disc

STEP 1 To select the disc to be ejected, touch the desired disc on the screen or press \wedge or \vee on .

STEP 2 Press  and remove the disc.

Ejecting all discs

Press and hold  until you hear a beep, then remove the discs.

Selecting a disc

To select a disc to play



Touch the desired disc on the screen or press \wedge or \vee on .

- Audio CD, CD text → P. 242
- MP3/WMA disc → P. 247
- DVD video/audio → P. 254
- Video CD → P. 266

3-3. Using the audio system

Playing DVD video/audio

For safety reasons, you can enjoy the visual contents of discs only when the vehicle is completely stopped with the “ENGINE START STOP” switch in ACCESSORY or IGNITION ON mode and the parking brake applied. While you are driving, only audio contents may be played.

■ Video control screen

Press  while the disc is playing, the following screen appears.

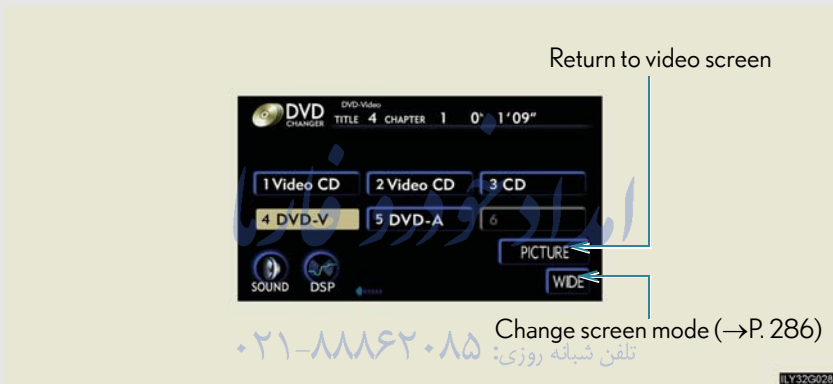



FarmaSOS.com

■ Control icon screen

Touch any part of the screen if no icons are shown while watching video, the following screen appears.

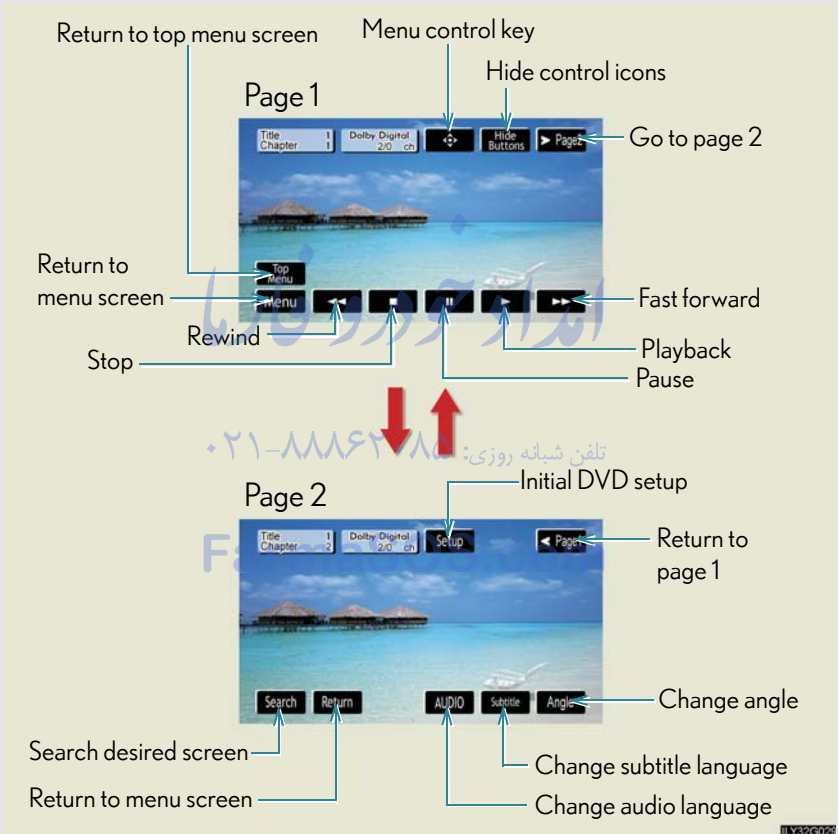
▶ DVD video mode



If  appears on the screen when you touch an icon, the operation relevant to that control is not permitted.

► DVD audio mode

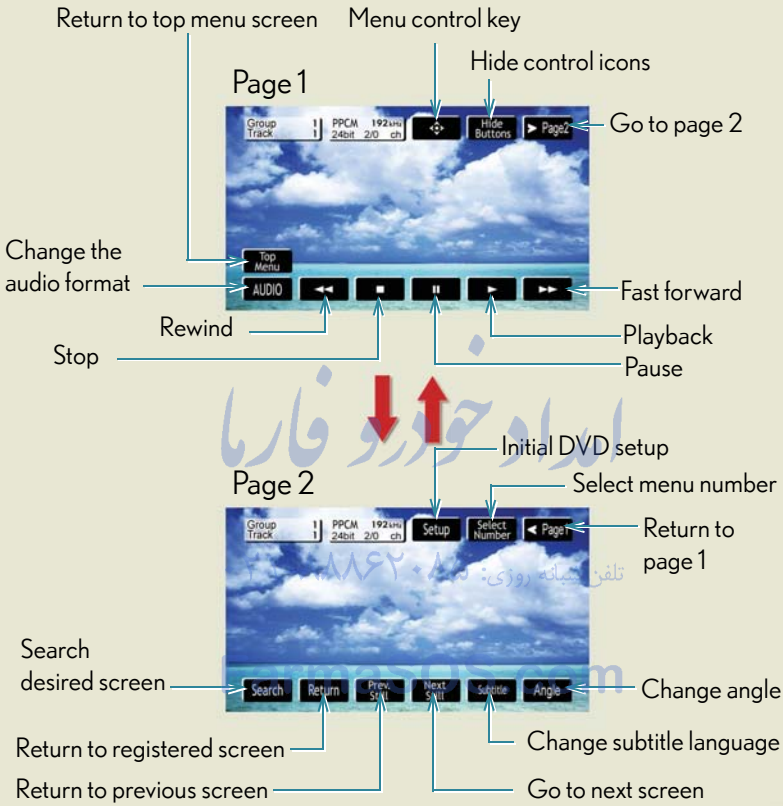



If  appears on the screen when you touch an icon, the operation relevant to that control is not permitted.

Loading, ejecting and selecting discs

→P. 252

Fast forwarding/rewinding disc

Touch and hold  or  on the screen or press and hold \wedge or \vee on  until you hear a beep.

Slow playback

Touch  and then touch . Video is played slowly while you are touching .

Searching a desired screen

■ Searching by title (DVD video mode)

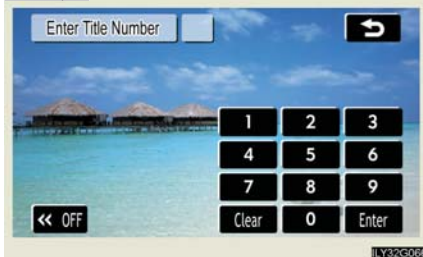

STEP 1 Touch  in the control icons.

STEP 2



Input the desired title number and then touch .

 **Clear** : Deletes the last input number.

 **OFF** : Hides the icons. To display the icons, touch  **ON** .

 **Return** : Returns to previous screen.

■ Searching by group (DVD audio mode)

STEP 1 Touch **Search** in the control icons.

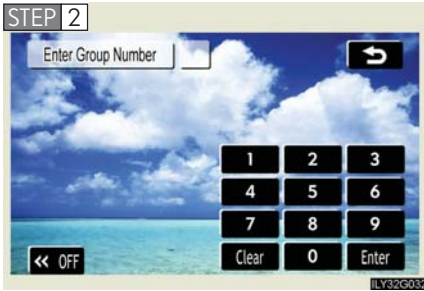

Input the group number and then touch **Enter**.

Clear: Deletes the last input number.

<< OFF: Hides the icons. To display the icons, touch **>> ON**.

↩: Returns to previous screen.

■ Playing a bonus group (DVD audio mode only, if the DVD has bonus options)

STEP 1 Touch **Search** in the control icons.



Input the desired bonus group number on the group search screen and touch **Enter**.

←: Deletes the number.

↩: Returns to previous screen.

■ Searching by chapter/track

Press **^** or **v** on  to select a chapter/track.

■ Selecting a menu number (DVD audio mode only)

STEP 1 Touch **Select Number** in the control icons.

STEP 2



Input the desired menu number on the screen and touch **Enter**.

Using the DVD menu

STEP 1 Touch **Menu** or **Top Menu** in the control icons.

Touch  if the menu control key does not appear on the menu screen.

STEP 2



Touch **▲**, **▼**, **◀** or **▶** to select a menu item, then touch **Enter** to select.

- Move Buttons**: Moves icons up or down.
- << OFF**: Hides icons. To display icons, touch **>> ON**.
- ↩**: Returns to previous screen.

Note that specific items or the operating method differs from one DVD to another. Refer to the manual that comes with the DVD disc. (The above image is an example.)

Changing the subtitle language



Touch **Subtitle** in the control icons.

Each time you touch the button, the next available language is selected.

Hide : Hides the control icons.

➔ : Returns to previous screen.

Changing the audio language (DVD video only)



Touch **AUDIO** in the control icons.

Each time you touch the button, the next available language is selected.

➔ : Returns to previous screen.

Changing the audio format (DVD audio only)

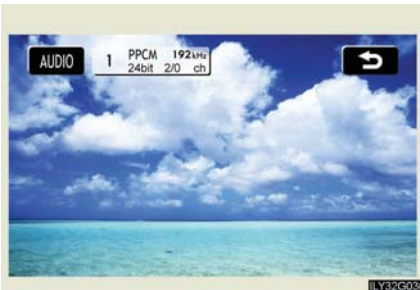

Touch **AUDIO** in the control icons.

Each time you touch the button, the next available audio format is selected.

➔ : Returns to previous screen.

Changing the angle (If the angle option is available)

STEP 1 Touch **Angle** in the control icons.



Touch the **Angle** button.

Each time you touch the button, the next available angle is selected.

Return: Returns to previous screen.

Initial DVD setup

■ Displaying “Setup Menu” screen

STEP 1 Touch **Setup** in the control icons.



After you change the initial settings, touch **Enter**.

Default: Restores default settings.

■ Setting audio language

STEP 1 Touch **Audio Language**.

STEP 2 Select the desired language.

If you cannot find the desired language, touch **Other** and input the desired language code. (→P. 263)

Return: Returns to previous screen.

■ Setting subtitle language

STEP 1 Touch **Subtitle Language**.

STEP 2 Select the desired language.

If you cannot find the desired language, touch **Other** and input the desired language code. (→P. 263)

↩: Returns to previous screen.

■ Setting menu language

STEP 1 Touch **DVD Language**.

STEP 2 Select the desired language.

If you cannot find the desired language, touch **Other** and input the desired language code. (→P. 263)

↩: Returns to previous screen.

■ Setting angle mark ON or OFF

If the DVD has angle options, you can turn the angle mark on or off.

Touch **Angle Mark**. Each time you touch the button, the multi angle mark on the screen turns on or off alternately.

■ Parental lock

STEP 1 Touch **Parental Lock**.

STEP 2



Input the 4-digit password and then touch **Enter**.

If you enter wrong numbers, touch **←** to delete the numbers.

Touch **←** 10 times to initialize the personal code.

STEP 3 Select a parental level (1 - 8).



↩: Returns to previous screen.

■ Entering a language code

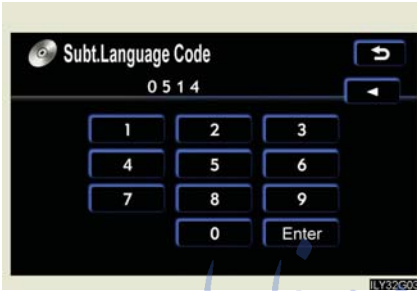
If you touch **Other** on the “Select Audio Language” screen, “Select Subtitle Language” screen or “Select DVD Language” screen, you can select a language by entering the 4-digit language code if that language is available.



Input the 4-digit language code and then touch **Enter**.

-  : Deletes the last input digit.
-  : Returns to previous screen.

● Language code

Code	Language	Code	Language	Code	Language
1001	Japanese	0512	Greek	0208	Bihari
0514	English	0101	Afar	0209	Bislama
0618	French	0102	Abkhazian	0214	Bengali
0405	German	0106	Afrikaans	0215	Tibetan
0920	Italian	0113	Amharic	0218	Breton
0519	Spanish	0118	Arabic	0301	Catalan
2608	Chinese	0119	Assamese	0315	Corsican
1412	Dutch	0125	Aymara	0319	Czech
1620	Portuguese	0126	Azerbaijani	0325	Welsh
1922	Swedish	0201	Bashkir	0401	Danish
1821	Russian	0205	Byelorussian	0426	Bhutani
1115	Korean	0207	Bulgarian	0515	Esperanto

3-3. Using the audio system

Code	Language	Code	Language	Code	Language
0520	Estonian	0914	Indonesian	1311	Macedonian
0521	Basque	0919	Icelandic	1312	Malayalam
0601	Persian	0923	Hebrew	1314	Mongolian
0609	Finnish	1009	Yiddish	1315	Moldavian
0610	Fiji	1023	Javanese	1318	Marathi
0615	Faroese	1101	Georgian	1319	Malay
0625	Frisian	1111	Kazakh	1320	Maltese
0701	Irish	1112	Greenlandic	1325	Burmese
0704	Scots-Gaelic	1113	Cambodian	1401	Nauru
0712	Galician	1114	Kannada	1405	Nepali
0714	Guarani	1119	Kashmiri	1415	Norwegian
0721	Gujarati	1121	Kurdish	1503	Occitan
0801	Hausa	1125	Kirghiz	1513	(Afan) Oromo
0809	Hindi	1201	Latin	1518	Oriya
0818	Croatian	1214	Lingala	1601	Panjabi
0821	Hungarian	1215	Laothian	1612	Polish
0825	Armenian	1220	Lithuanian	1619	Pashto, Pushto
0901	Interlingua	1222	Latvian	1721	Quechua
0905	Interlingue	1307	Malagasy	1813	Rhaeto- Romance
0911	Inupiak	1309	Maori	1814	Kirundi

Code	Language	Code	Language	Code	Language
1815	Romanian	1919	Siswati	2019	Tsonga
1823	Kinyarwanda	1920	Sesotho	2020	Tatar
1901	Sanskrit	1921	Sundanese	2023	Twi
1904	Sindhi	1923	Swahili	2111	Ukrainian
1907	Sangho	2001	Tamil	2118	Urdu
1908	Serbo-Croatian	2005	Telugu	2126	Uzbek
1909	Sinhalese	2007	Tajik	2209	Vietnamese
1911	Slovak	2008	Thai	2215	Volapük
1912	Slovenian	2009	Tigrinya	2315	Wolof
1913	Samoan	2011	Turkmen	2408	Xhosa
1914	Shona	2012	Tagalog	2515	Yoruba
1915	Somali	2014	Setswana	2621	Zulu
1917	Albanian	2015	Tonga		
1918	Serbian	2018	Turkish		

■ Error messages

If “Region Code Error” is displayed, check the region code printed on the DVD matches the player’s region code.

If a different message is displayed: →P. 270

3-3. Using the audio system

Playing video CD

For safety reasons, you can enjoy the visual contents of discs only when the vehicle is completely stopped with the “ENGINE START STOP” switch in ACCESSORY or IGNITION ON mode and the parking brake applied. While you are driving, only audio contents may be played.

■ Video control screen

Press  while the disc is playing, the following screen appears.

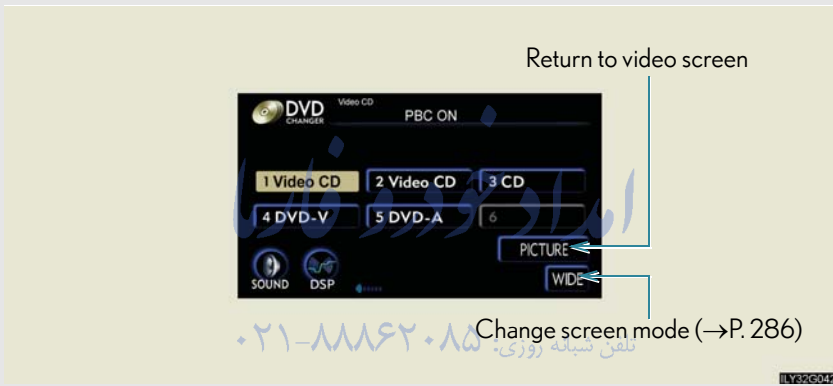

FarmaSOS.com

■ Control icon screen

Touch any part of the screen if no icons are shown while watching a video CD, the following screen appears.

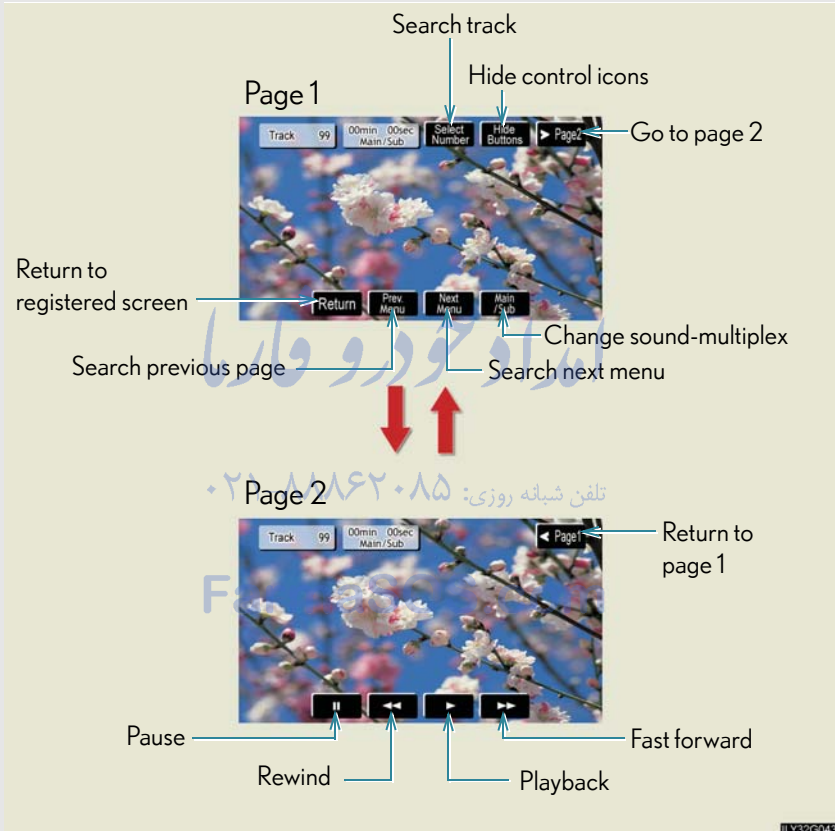



If  appears on the screen when you touch an icon, the operation relevant to that control is not permitted.

Loading, ejecting and selecting discs

→P. 243

Fast forwarding/rewinding the video CD

Touch and hold  or  in the control icons or press and hold

∧ or ∨ on  until you hear a beep.

Slow playback

Touch  and then touch  in the control icons. Video is played slowly while you are touching .

Using the video CD menu

Touch  in the control icons.

Refer to the manual that comes with the video CD for specific menu items.

Selecting a desired screen

■ Searching manually

Touch **Prev. Menu** or **Next Menu** on the screen, or press \wedge or \vee on  until the desired screen appears.

■ Searching by number

STEP 1 Touch **Select Number** in the control icons.

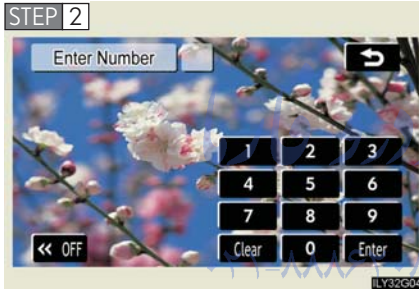

Input the desired track number on the screen and touch **Enter**.

Clear: Deletes the last input number.

<< OFF: Hides icons. To display icons, touch **>> ON**.

>>: Returns to previous screen.

Changing the sound-multiplex mode

Touch **Main/Sub** of the control icons. The mode cycles through each time the button is touched.

“Main” → “Sub” → “Main/Sub”



■ Error messages

→P. 270

3-3. Using the audio system

DVD player and DVD video disc information

■ Error messages

Refer to the following table and take the appropriate measures. If the problem is not rectified, take the vehicle to your Lexus dealer.







Message	Cause	Correction Procedures
No CD or No Disc	There is no disc in the CD or DVD changer	Insert a disc
Check CD X or Check DISC X	<ul style="list-style-type: none">• The disc X is dirty or damaged• The disc X is inserted upside down• The disc X is not playable with the player	<ul style="list-style-type: none">• Clean the disc• Insert the disc correctly• Confirm the disc is playable with the player
CD Error or DVD Error	<ul style="list-style-type: none">• There is a malfunction within the system• Operation is stopped due to a high temperature inside the player	<ul style="list-style-type: none">• Eject the disc• Eject the disc and allow the player to cool down
NO MUSIC FILE	This indicates that no playable data is included in the disc	Eject the disc

■ DVD video discs

The DVD player conforms to NTSC color TV formats.

Region code: Some DVD video discs have a region code indicating the region in which you can use the DVD video disc. If the DVD video disc is not labeled as “ALL” or “1”, you cannot use it on this DVD player. If you attempt to play an inappropriate DVD video disc on this player, “Region Code Error” appears on the screen. Even if the DVD video disc does not have a region code, you may not be able to use it.

■ Symbols shown on DVD video discs

Mark	Meaning
	Indicates NTSC format.
	Indicates the number of audio tracks.
	Indicates the number of language subtitles.
	Indicates the number of angles.
	Indicates the screen display ratios available. Wide screen: 16:9 Standard: 4:3
	Indicates the disc's region code. ALL: In all countries Number: Region code

■ DVD compatibility



Use only discs marked as shown to the left. The following products may not be playable on your DVD player.

- SACDs
- dts-CDs
- Copy-protected CDs
- DVD-Rs
- DVD+Rs
- DVD-RWs
- DVD+RWs
- DVD-ROMs
- DVD-RAMs

■ CD/DVD player protection feature

To protect the internal components, playback is automatically stopped when a problem is detected.

■ If discs are left inside the CD/DVD player or in the ejected position for extended periods

Discs may be damaged and may not play properly.

■ Lens cleaners

Do not use lens cleaners. Doing so may damage the CD/DVD player.

■ DVD video disc information

● DVD video discs

Digital Versatile Disc that holds video. DVD video discs have adopted "MPEG2", one of the world standards of digital compression technologies. The picture data is compressed by 1/40 on average and stored. Variable rate encoding technology in which the volume of data assigned to the picture is changed depending on the picture format has also been adopted. Audio data is stored using PCM and Dolby digital, which enables higher quality of sound. Furthermore, multi-angle and multi-language features will also help you enjoy the more advanced technology of DVD video.

● Viewer restrictions

This feature limits what can be viewed in conformity with the level of restrictions of the country. The level of restrictions varies depending on the DVD video disc. Some DVD video discs cannot be played at all, or violent scenes are skipped or replaced with other scenes.

Level 1: DVD video discs for children can be played.

Level 2-7: DVD video discs for children and G-rated movies can be played.

Level 8: All types of DVD video discs can be played.

● Multi-angle option

You can enjoy the same scene from different angles.

● Multi-language option

You can select the subtitle and audio languages.

● Region codes

The region codes are found on DVD players and DVD discs. If a DVD video disc does not have the same region code as the DVD player, you cannot play the disc on that DVD player. (→P. 271)

3-3. Using the audio system

- Audio

This DVD player can play linear PCM, Dolby Digital and MPEG audio format DVD. Other decoded types cannot be played.

- Title and chapter

Video and audio programs stored in DVD video discs are divided into parts by title and chapter.

Title: The largest unit of the video and audio programs stored on DVD video discs. Usually, one movie, one album, or one audio program is assigned as a title.

Chapter: A title is comprised of one or more chapters.

■ Sound

- Dolby Digital

Manufactured under license from Dolby Laboratories.

“Dolby”, “Pro Logic”, and the double-D symbol are trademarks of Dolby Laboratories. Confidential unpublished works.

©1992-1997 Dolby Laboratories. All rights reserved.

This product incorporates copyright protection technology that is protected by method claims of certain U. S. patents and other intellectual property rights owned by Macrovision Corporation and other rights owners. Use of this copyright protection technology must be authorized by Macrovision Corporation, and is intended for home and other limited viewing uses only unless otherwise authorized by Macrovision Corporation.

Reverse engineering or disassembly is prohibited.

- DTS

“DTS” and “DTS Digital Surround” are registered trademarks of Digital Theater System, Inc.

■ MP3 and WMA files

MP3 (MPEG Audio LAYER 3) is a standard audio compression format.

Files can be compressed to approximately 1/10 of their original size by using MP3 compression.

WMA (Windows Media TMAudio) is a Microsoft audio compression format.

This format compresses audio data to a size smaller than that of the MP3 format.

There is a limit to the MP3 and WMA file standards and to the media/formats recorded by them that can be used.

● MP3 file compatibility

- Compatible standards
MP3 (MPEG1 LAYER3, MPEG2 LSF LAYER3)
- Compatible sampling frequencies
MPEG1 LAYER3: 32, 44.1, 48 (kHz)
MPEG2 LSF LAYER3: 16, 22.05, 24 (kHz)
- Compatible bit rates
MPEG1 LAYER3: 64, 80, 96, 112, 128, 160, 192, 224, 256, 320 (kbps)
- MPEG2 LSF LAYER3: 64, 80, 96, 112, 128, 144, 160 (kbps)
*: Compatible with VBR
- Compatible channel modes: stereo, joint stereo, dual channel and monaural

● WMA file compatibility

- Compatible standards
WMA Ver. 7, 8, 9
- Compatible sampling frequencies
32, 44.1, 48 (kHz)
- Compatible bit rates
Ver. 7, 8: CBR 48, 64, 80, 96, 128, 160, 192 (kbps)
Ver. 9: CBR 48, 64, 80, 96, 128, 160, 192, 256, 320 (kbps)
*: Only compatible with 2-channel playback

- Compatible media

Media that can be used for MP3 and WMA playback are CD-Rs and CD-RWs.

Playback in some instances may not be possible, depending on the status of the CD-R or CD-RW. Playback may not be possible or the audio may jump if the disc is scratched or marked with fingerprints.

- Compatible disc formats

The following disc formats can be used.

- Disc formats: CD-ROM Mode 1 and Mode 2
CD-ROM XA Mode 2, Form 1 and Form 2
- File formats: ISO9660 level 1, level 2, (Romeo, Joliet)
MP3 and WMA files written in any format other than those listed above may not play correctly, and their file names and folder names may not be displayed correctly.

Items related to standards and limitations are as follows:

- Maximum directory hierarchy: 8 levels
- Maximum length of folder names/file names: 32 characters
- Maximum number of folders: 192 (including the root)
- Maximum number of files per disc: 255

- File names

The only files that can be recognized as MP3/WMA and played are those with the extension .mp3 or .wma.

- Multi-sessions

As the audio system is compatible with multi-sessions, it is possible to play discs that contain MP3 and WMA files. However, only the first session can be played.

- ID3 and WMA tags

ID3 tags can be added to MP3 files, making it possible to record the track title and artist name, etc.

The system is compatible with ID3 Ver. 1.0, 1.1, and Ver. 2.2, 2.3 ID3 tags. (The number of characters is based on ID3 Ver. 1.0 and 1.1.)

WMA tags can be added to WMA files, making it possible to record the track title and artist name in the same way as with ID3 tags.

- MP3 and WMA playback

When a disc containing MP3 or WMA files is inserted, all files on the disc are first checked. Once the file check is finished, the first MP3 or WMA file is played. To make the file check finish more quickly, we recommend you do not write in any files other than MP3 or WMA files or create any unnecessary folders.

Discs that contain a mixture of music data and MP3 or WMA format data cannot be played.

- Extensions

If the file extensions .mp3 and .wma are used for files other than MP3 and WMA files, they will be mistakenly recognized and played as MP3 and WMA files. This may result in large amounts of interference and damage to the speakers.

تلفن شبانه روزی: ۰۲۱-۸۸۶۲۰۸۵

FarmaSOS.com

● Playback

- To play MP3 files with steady sound quality, we recommend a fixed bit rate of 128 kbps and a sampling frequency of 44.1 kHz.
- CD-R or CD-RW playback may not be possible in some instances, depending on the characteristics of the disc.
- There is a wide variety of freeware and other encoding software for MP3 and WMA files on the market, and depending on the status of the encoding and the file format, poor sound quality or noise at the start of playback may result. In some cases, playback may not be possible at all.
- When files other than MP3 or WMA files are recorded on a disc, it may take more time to recognize the disc and in some cases, playback may not be possible at all.
- Microsoft, Windows, and Windows Media are the registered trademarks of Microsoft Corporation in the U.S. and other countries.

■ CD-R and CD-RW discs

- CD-R/CD-RW discs that have not been subject to the “finalizing process” (a process that allows discs to be played on a conventional CD player) cannot be played.
- It may not be possible to play CD-R/CD-RW discs recorded on a music CD recorder or a personal computer because of disc characteristics, scratches or dirt on the disc, or dirt, condensation, etc. on the lens of the unit.

FarmaSOS.com

- It may not be possible to play discs recorded on a personal computer depending on the application settings and the environment. Record with the correct format. (For details, contact the appropriate application manufacturers of the applications.)
- CD-R/CD-RW discs may be damaged by direct exposure to sunlight, high temperatures or other storage conditions. The unit may be unable to play damaged discs.
- If you insert a CD-RW disc into the MP3/WMA player, playback will begin more slowly than with a conventional CD or CD-R disc.
- Recordings on CD-R/CD-RW cannot be played using the DDCD (Double Density CD) system.

CAUTION

■ DVD video precaution

Conversational speech on some DVDs is recorded at a low volume to emphasize the impact of sound effects. If you adjust the volume assuming that the conversations represent the maximum volume level that the DVD will play, you may be startled by louder sound effects or when you change to a different audio source.

Loud sounds may have a significant impact on the human body or pose a driving hazard. Keep this in mind when you adjust the volume.

 NOTICE

■ Discs and adapters that cannot be used

Do not use the following types of discs, 3 in. (8 cm) disc adapters or Dual Disc. Doing so may damage the player and render the disc insert/eject function unusable.



- Discs that have a diameter that is not 4.7 in. (12 cm).

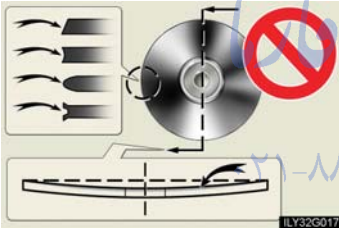

- Low-quality and deformed discs.



- Discs with a transparent or translucent recording area.



- Discs that have tape, stickers or CD-R labels attached to them, or that have the label peeled off.

 NOTICE

■ Player precautions

Failure to follow the precautions below may result in damage to the discs or the player itself.

- Do not insert anything other than discs into the disc slot.
- Do not apply oil to the player.
- Store discs away from direct sunlight.
- Never try to disassemble any part of the player.



- Do not insert more than one disc at a time.

تلفن شبانه روزی: ۰۲۱-۸۸۶۲۰۸۵

FarmaSOS.com

3-3. Using the audio system

Optimal use of the audio/video system

Press  on the panel to display the audio/video control screen.

► Operating the radio, cassette and audio CD



► Operating the DVD video/audio and video CD



Adjusting sound quality and balance





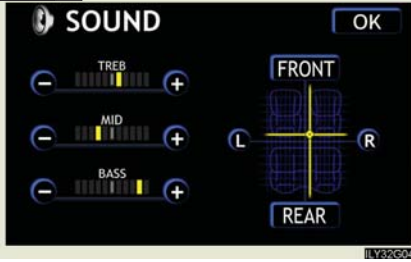

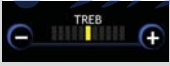

STEP 1 Touch  on the screen.

STEP 2

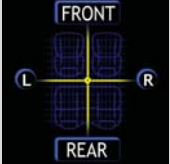

Adjust the settings, referring to the following table.

Once you have finished, touch .

Sound quality mode	Display	Level	Touch
High-pitched tones*		-5 to 5	 or 
Mid-pitched tones*		-5 to 5	
Low-pitched tones*		-5 to 5	
Front/rear volume balance		F7 to R7	 or 
Left/right volume balance		L7 to R7	 or 

*: The sound quality level is adjusted individually in each radio, cassette tape, CD or DVD mode.

Setting DSP

The following features can be set as desired by touching  on the screen.

► With CD player

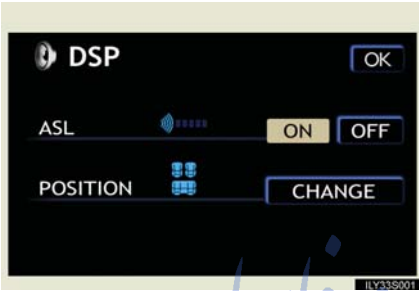

► With DVD player

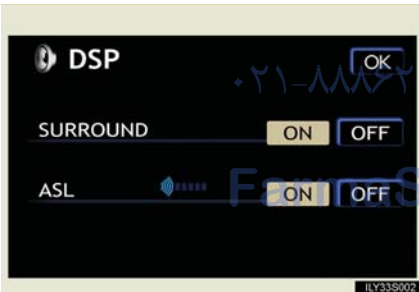

■ Turning Automatic Sound Levelizer (ASL) ON or OFF

Touch **ON** or **OFF**.





ASL automatically adjusts the volume and tone quality according to the noise level as you drive your vehicle.

■ Changing the listening position (with CD player)

The speaker balance can be changed to produce the best sound for each listening position.

Touch **CHANGE**.

The listening position changes as follows each time the switch is touched.

Display	Listening position
	Position best suited to the driver's seat
	Position best suited to the driver's and front passenger's seat
	Position best suited to the rear seats
	Position best suited to all seats

■ Turning the surround ON or OFF (with DVD player)

Touch **ON** or **OFF**.

Setting the screen ratio mode (with DVD player)

STEP 1 Touch **WIDE** on the screen.



Touch one of the **NORMAL**, **WIDE1** or **WIDE2** to match screen ratio printed on the DVD.

Screen ratio mode	Details
NORMAL	Suitable for 4:3 screen ratio
WIDE1	Expand the Normal screen horizontally to fill the display.
WIDE2	Suitable for 16:9 screen ratio

3-3. Using the audio system

Using the AUX adapter

This adapter can be used to connect a portable audio device and listen to it using the vehicle's speakers.



Connect the portable audio device.

STEP 2 Press **DISC/AUX**.

■ Operating portable audio devices connected to the audio system

The volume can be adjusted using the vehicle's audio controls. All other adjustments must be made on the portable audio device itself.

FarmaSOS.com

3-3. Using the audio system

Using the steering switches

Some audio features can be controlled using the steering switches.



1 Power on, select audio source

2 Volume

3 Radio: Select radio stations
Cassette: Fast forward, rewind and selecting tracks

CD: Select tracks, discs and file

DVD: Select tracks, discs and chapter

Turning on the power

Press  when the audio system is off.

The audio system can be turned off by holding the switch down for 1 second or more.

Changing the audio source

Press  when the audio system is on. The audio source changes as follows each time the button is pressed. If a cassette tape or discs is not inserted, that mode will be skipped.

FM1 → FM2 → cassette player → CD/DVD player
→ AUX → AM → SAT1 → SAT2 → SAT3

Adjusting the volume

Press "+" on  to increase the volume and "-" to decrease the volume.

Hold down the button to continue increasing or decreasing the volume.

Selecting a radio station

STEP 1 Press  to select the radio mode.

STEP 2 Press ^ or v on  to select a radio station.

To scan for receivable stations, press and hold the switch until you hear a beep.

Fast forwarding or rewinding the cassette

STEP 1 Press  to select the cassette mode.

STEP 2 Press and hold ^ or v on  until you hear a beep.

To stop fast forwarding or rewinding, press the same switch.

Selecting a track/file or chapter

STEP 1 Press  to select the cassette mode, CD or DVD mode.

STEP 2 Press ^ or v on  to select the desired track or chapter.

Cassette mode only: you can skip maximum 9 tracks.

Selecting a disc in the CD or DVD player

STEP 1 Press  to select the CD or DVD mode.

STEP 2 Press and hold  or  until you hear a beep.

■ Canceling automatic selection of a radio station

Push the same switch.

CAUTION

■ To reduce the risk of an accident

Exercise care when operating the audio switches on the steering wheel.

امداد خودرو فارما

تلفن شبانه روزی: ۰۲۱-۸۸۶۲۰۸۵

FarmaSOS.com

3-4. Using the hands-free system (for cellular phone)

Hands-free system (for cellular phone)

The hands-free system is a function that allows you to use your mobile phone without touching it.

This system supports Bluetooth® mobile phones. Bluetooth® is a wireless data system that allows the mobile phone to wirelessly connect to the hands-free system and make/receive calls.

► Telephone switch



- 1 Sending/Receiving/"Telephone" screen display (when stopped)
- 2 End call

► Microphone



The person you are speaking to can be heard from the driver's side speaker.



To use the hands-free system you must register your Bluetooth® phone in the system. (→P.296)

Status display

You can check such indicators as signal strength and battery charge on the “Telephone” screen.



- 1 Connection status
- 2 Battery charge
- 3 Call area
- 4 Signal strength

Indicators	Conditions
Connection status	Blue: Good Yellow: Bad  : Not connected
Battery charge	 : Full  : Low
Call area	“Rm”: Roaming area “Hm”: Home area
Signal strength	 : Good  : Bad  : Not connected

■ When using the hands-free system

- The audio system and voice guidance are muted when making a call.
- If both parties speak at the same time, it may be difficult to hear.
- If the received call volume is overly loud, an echo may be heard.
- Try to face toward the microphone as much as possible when speaking.
- In the following circumstances it may be difficult to hear the other party.
 - When driving on unsealed roads
 - When driving at high speeds
 - If a window is open
 - If the air conditioning is blowing directly on the microphone
 - If the air conditioning is set to high

■ Conditions under which the system will not operate

- If using a mobile phone that does not support Bluetooth®.
- If the mobile phone is switched off.
- If you are outside service range.
- If the mobile phone is not connected. *تلفن شبانه روزی: ۸۵*
- If the mobile phone's battery is low.

■ Bluetooth® antenna

The antenna is built into the display. If the mobile phone is behind the seat or in the console box, or touching or covered by metal objects, connection status may deteriorate.

3-4. Using the hands-free system (for cellular phone)

■ Battery charge/Signal status

This display may not correspond exactly with the mobile phone itself.

■ About Bluetooth®



Bluetooth is a registered trademark of Bluetooth SIG, Inc.

■ Compatible models

Compatible with HFP (Hands Free Profile) Ver. 1.0 and OPP (Object Push Profile) Ver. 1.1.

If your cellular phone does not support HFP, you cannot enter the Bluetooth® phone, and take OPP service individually.

■ Certification for the hands-free system

FCC ID: HYQBT0501A
IC ID: 1551A-BT0501A

تلفن شبانه روزی: ۰۸۵-۸۸۶۲۰۲۱

This device complies with Part 15 of the FCC Rules and RSS-210. Operation is subject to the following two conditions: (1) This device may not cause harmful interference, and (2) This device must accept any interference received, including interference that may cause undesired operation.

⚠ CAUTION**■ FCC WARNING**

Changes or modifications not expressly approved by the party responsible for compliance could void the user's authority to operate the equipment.

Radio Frequency Exposure. This device is approved for Mobile Application only and, to comply with applicable FCC radio frequency exposure regulations, must be used with a distance of at least 7.9 in. (20 cm) between the antenna and the body of any person at all time during use.

■ While driving

Do not use the mobile phone or connect the Bluetooth® system.

⚠ NOTICE**■ When leaving the vehicle**

Do not leave your mobile phone in the vehicle. The inside of the vehicle may become hot, causing damage to the phone.

تلفن شبانه روزی: +۲۱-۸۸۶۲۰۸۵



FarmaSOS.com

3-4. Using the hands-free system (for cellular phone)

Using the Bluetooth® phone

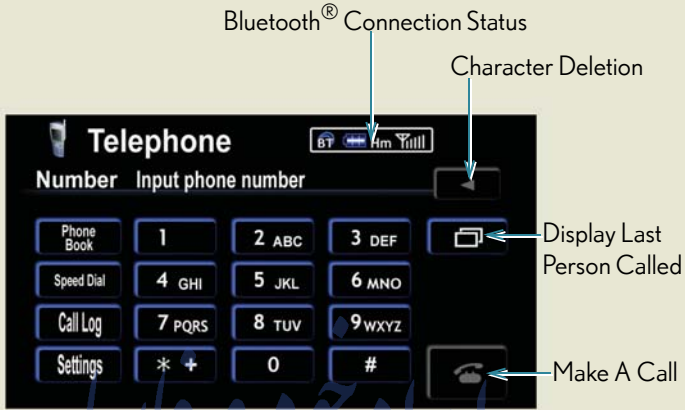
► Telephone screen



To display the screen shown above, press , then touch  on the "Information" screen.

Registering a Bluetooth® phone

You can register up to 6 phones in the system.

STEP 1 Press .

STEP 2 Touch  on the "Information" screen.

STEP 3 Touch  on the "Telephone" screen.



Touch .



Touch .

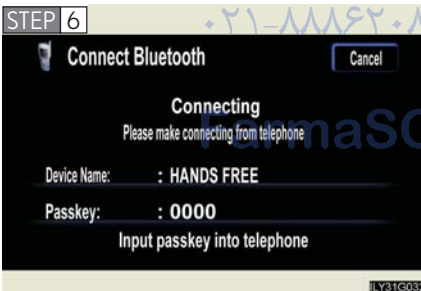

Input the passkey displayed on screen into your phone.

If the message "Bluetooth* connection successful" is displayed, registration is complete.

If the message "Bluetooth* connection failed. Please check the "Passkey" and the settings of the telephone" is displayed, start again from the beginning.

*: Bluetooth is a registered trademark of Bluetooth SIG, Inc.

Bluetooth® phone connection

There are two connection methods available—automatic and manual.

STEP 1 Press .

STEP 2 Touch  on the “Information” screen.

STEP 3 Touch  on the “Telephone” screen.

STEP 4 Choose one of the following methods.



1 Automatic connection

If the “ENGINE START STOP” switch is in the ACCESSORY or IGNITION ON mode, the system will automatically connect to the Bluetooth® phone. Touching automatic connection will turn it on/off.

2 Manual connection

If automatic connection fails or is turned off, connection must be made manually.

If the message “Bluetooth* connection successful” is displayed, connection is complete.

*: Bluetooth is a registered trademark of Bluetooth SIG, Inc.

Reconnecting to the Bluetooth® phone

If the system cannot connect due to poor signal strength with the “ENGINE START STOP” switch in the ACCESSORY or IGNITION ON mode, the system will automatically attempt to reconnect.

If the phone is turned off, the system will not attempt to reconnect. In this case, connection must be made manually, or the phone must be re-selected.

Making a call

Once the Bluetooth[®] phone is registered, you can make a call using the following procedure.

■ Dialing

STEP 1 Press .

STEP 2 Touch  on the “Information” screen.

STEP 3  Inputting the phone number.



To delete the input phone number, touch .

To dial the last input phone number, touch .

STEP 4 Touch  or press  on the steering wheel.

FarmaSOS.com

3-4. Using the hands-free system (for cellular phone)

■ Dialing from the phone book

You can dial a number from the phone book data imported from your mobile phone. Up to 1000 entries may be stored in the phone book. (→P. 320)

STEP 1 Press .

STEP 2 Touch  on the "Information" screen.

STEP 3 Touch  on the "Telephone" screen.

STEP 4

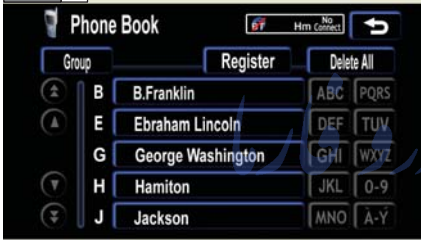



Choose the data to call from the list.

STEP 5



Choose the number and then

touch  or press  on the steering wheel.

■ Dialing from history

You can make a call from past dialed numbers or received calls.

Up to 5 numbers are stored, with the last recent number being deleted to make room for a new number.

STEP 1 Press .

STEP 2 Touch  on the "Information" screen.

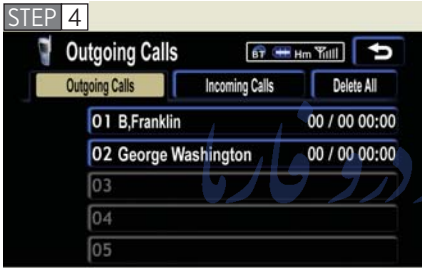

STEP 3 Touch  on the "Telephone" screen.

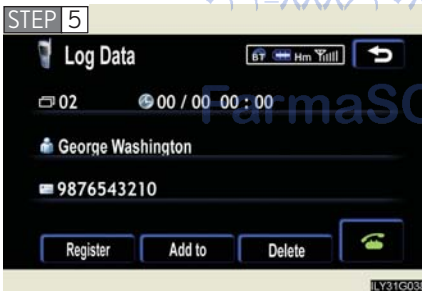

Choose the number to call from the list.

To choose a number from the incoming calls history, touch  and choose a number to call.



Touch  or press  on the steering wheel.

3-4. Using the hands-free system (for cellular phone)

■ Calling using speed dial

You can make a call using numbers registered from the phone book and call history. (→P. 312)

STEP 1 Press .

STEP 2 Touch  on the "Information" screen.

STEP 3 Touch  on the "Telephone" screen.

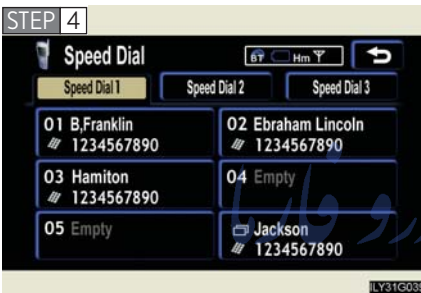

Choose the desired number to make a call.

To change the page, touch  or .

تلفن شبانه روزی: ۰۸۵-۸۸۶۲-۲۱

FarmaSOS.com

■ Calling using voice recognition

Using voice recognition, you can call by name from the “Phone Book” screen, call by number from the “Telephone” screen, and send tones from the “Call” screen. (→P. 308)

▶ Talk switch



● Calling by name from the “Phone Book” screen

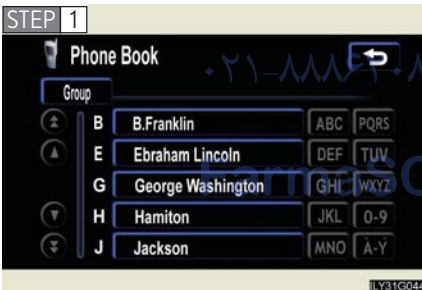

Press the talk switch.

STEP 1 Following the system guidance, wait until the beep and then say the desired name.

If there are multiple entries for the same name, “Next” will be displayed.

To select the next candidate, touch **Next** or say “Next candidate”.

STEP 3 Following the system guidance, press the talk switch.

STEP 4 Following the system guidance, wait until the beep and then say “Dial”.

3-4. Using the hands-free system (for cellular phone)

● Calling by number from the “Telephone” screen



Press the talk switch.

STEP 2 Following the system guidance, wait until the beep and then say the desired number.

STEP 3 Following the system guidance, press the talk switch.

STEP 4 Following the system guidance, wait until the beep and then say “Dial”.

● Sending tones from the “Call” screen



Press the talk switch.

STEP 2 Following the system guidance, wait until the beep and then say the desired number.



STEP 3 Following the system guidance, press the talk switch.

STEP 4 Following the system guidance, wait until the beep and then say “Yes”.

■ Calling using POI

You can make a call using a Point Of Interest. (→“Navigation System Owner’s Manual”)

■ Made/Received call history list

- If you make a call to or receive a call from a number registered in the phone book, the name is displayed in the call history.
- If you make multiple calls to the same number, only the last call made is displayed in the made calls history.
-  is displayed to the left of phone number for unanswered calls.
-  is displayed to the left of the phone number for refused calls.
- Calls where the number is unavailable, such as public telephones, are not stored in the call history.

■ When driving

- The functions “Dialing”, “Dialing from the phone book”, and “Dialing from history” are unavailable.
- If you press  on the steering wheel, the “Speed Dial” screen is displayed. At this time phone numbers will not be displayed. Choose from the names displayed to make a call.

■ International calls

You may not be able to make international calls, depending on the mobile phone in use.

3-4. Using the hands-free system (for cellular phone)

■ To display the voice recognition command list



STEP 1 After pressing the talk switch, press **Help**. If the "Operating Guide" screen is displaying, press **Command List**.

STEP 2 Press **Tel**.

■ To display the voice recognition operating guide

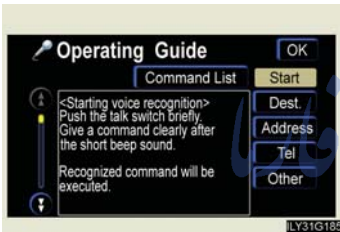

STEP 1 After pressing the talk switch, press **Help**. If the "Command List" screen is displaying, press **Operating Guide**.

STEP 2 Press **Tel**.

■ To cancel voice recognition

- Press and hold the talk switch.
- Press  on the steering wheel.
- Say "Cancel".
- Press **Cancel**. (excluding command verification)



■ When using voice recognition

Use correct commands and speak clearly, otherwise the system may not correctly recognize the command. Wind or other noises may also cause the system not to recognize the desired command.

Receiving a call

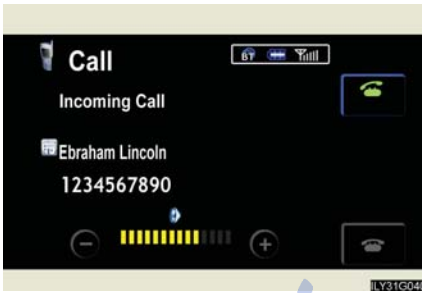
When a call is received, the following screen is displayed together with a sound.





Touch  or press  on the steering wheel.

■ To refuse a call

Touch and hold .

■ To adjust the received call volume

Press the  or . You can also adjust the volume using the steering switches.

■ International calls

Received international calls may not be displayed correctly, depending on the mobile phone in use.



FarmaSOS.com

Speaking on the phone

The following screen is displayed when speaking on the phone.



■ To adjust the received call volume

Press the  or . You can also adjust the volume using the steering switches.

■ To prevent the other party from hearing your voice

Touch . تلفن شبانه روزی: ۰۲۱-۸۸۶۲۰۸۵

■ Inputting a key

When using phone services such as an answering service or a bank, you can store phone numbers and code numbers in the phone book.

STEP 1 Touch **0-9**.

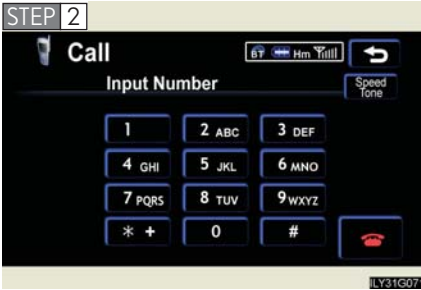

Input the number.

If repeated tone symbols* are stored in the phone book, **Send** and **Exit** are displayed on the right side of the screen.

*: Repeated tone symbols are symbols or numbers displayed as p or w, that come after the phone number.

(e.g. 056133p0123w#1*)

STEP 3 Confirm the number displayed on screen, and touch **Send**.

If you touch **Exit**, operation is completed without making a call.

■ To transfer a call

Touch **Transfer Call**.

■ To hang up

Touch  or press  on the steering wheel.

FarmaSOS.com

■ Transferring calls

- It is not possible to transfer from hands-free to the mobile phone while driving.
- If you transfer from the mobile phone to hands-free, the hands-free screen will be displayed, and you can operate the system using the screen.
- Transfer method and operation may vary according to the mobile phone used.
- For operation of the mobile phone in use, see the phone's manual.

■ To send a tone by speed tone

Touch **0-9** then touch **Speed Tone**. Choose the desired number from the speed tone list displayed.

■ While driving

Key input is unavailable.

امداد خودرو فارما

تلفن شبانه روزی: ۰۲۱-۸۸۶۲۰۸۵

FarmaSOS.com



3-4. Using the hands-free system (for cellular phone)

Setting the hands-free system

You can speed dial, register in and edit the phone book, and set the Bluetooth® phone.

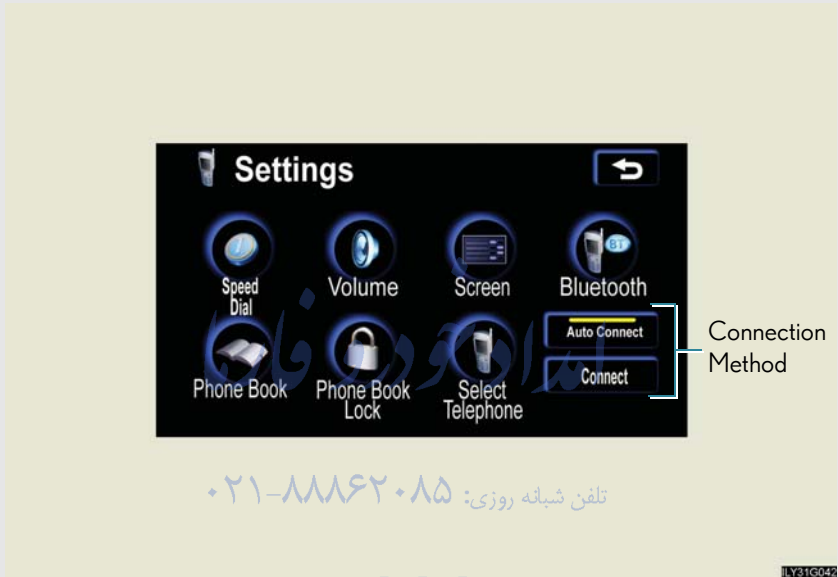
► Settings screen



To display the screen shown above, press , touch  on the "Information" screen, then touch  on the "Telephone" screen.

Registering/Deleting a speed dial item

■ Registering a speed dial item

You can register a number from the phone book or the call history. Up to 17 entries may be stored.

STEP 1 Press .

STEP 2 Touch  on the "Information" screen.

STEP 3 Touch  on the "Telephone" screen.

STEP 4 Touch  on the "Settings" screen.

STEP 5 Touch  in the "Speed Dial" section of the "Speed Dial Settings" screen.



STEP 6 Select the data to be registered.

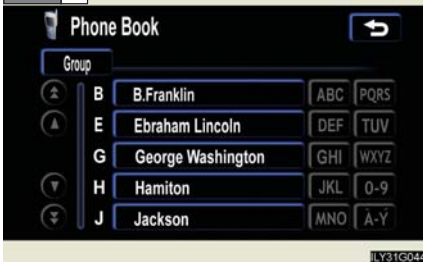

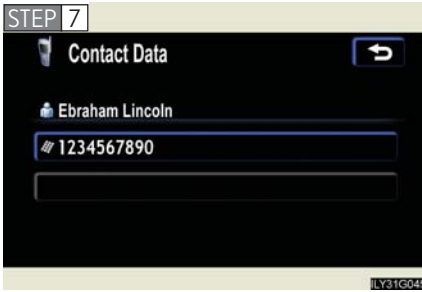

Select the number to be registered.

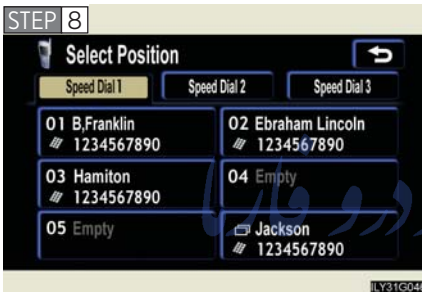

Press the desired switch.

The last dialed number will be registered in position 6.

■ Deleting a speed dial item

STEP 1 Press .

STEP 2 Touch  on the "Information" screen.

STEP 3 Touch  on the "Telephone" screen.

STEP 4 Touch  on the "Settings" screen.

STEP 5 Touch  in the "Speed Dial" section of the "Speed Dial Settings" screen.

STEP 6 Select the data to be deleted.

STEP 7 A confirmation message will be displayed. If everything is correct, touch .

■ To delete all speed dial items

Follow the steps for “Deleting a speed dial item” to “STEP 5”. In the “Speed Dial” section of the “Speed Dial Settings” screen, touch the **Delete All** . A confirmation message will be displayed. If everything is correct, touch **Yes** .

Registering/Editing/Deleting a Speed Tone

■ Registering a speed tone

You can register up to 6 items.

STEP 1 Press **INFO** .

STEP 2 Touch **Telephone** on the “Information” screen.

STEP 3 Touch **Settings** on the “Telephone” screen.

STEP 4 Touch **Speed Tone** on the “Settings” screen.

STEP 5 Touch **Register** in the “Speed Tone” section.



STEP 6



Input the desired name and touch

OK .

A-Z , **À-ÿ** : Letter input

0-9 : Number/Symbol input

Space : Space

← : Backspace

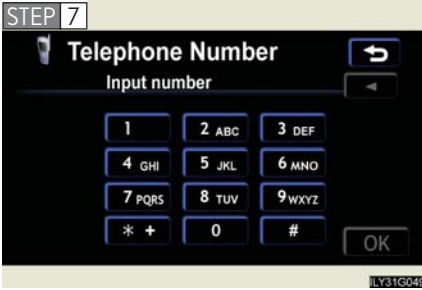

Input the number and touch **OK**.

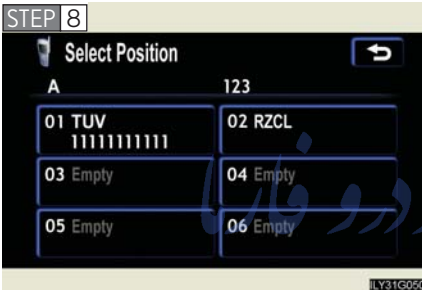

Touch the desired switch.

■ Editing a speed tone

STEP 1 Press **INFO**.

STEP 2 Touch **Telephone** on the "Information" screen.

STEP 3 Touch **Settings** on the "Telephone" screen.

STEP 4 Touch **Speed Tone** on the "Settings" screen.

STEP 5 Touch **Edit** in the "Speed Tone" section of the "Speed Dial Settings" screen.

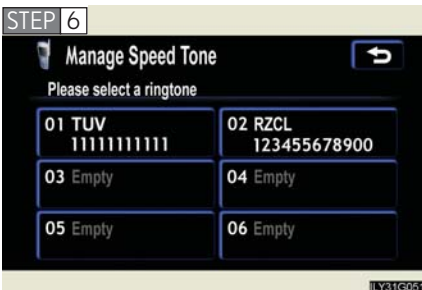

Touch the switch to be edited.

3-4. Using the hands-free system (for cellular phone)

STEP 7 Input the name and touch **OK**.

STEP 8 Input the number and touch **OK**.

■ Deleting a speed tone

STEP 1 Press .

STEP 2 Touch  on the “Information” screen.

STEP 3 Touch **Settings** on the “Telephone” screen.

STEP 4 Touch  on the “Settings” screen.

STEP 5 Touch **Delete** in the “Speed Tone” section of the “Speed Dial Settings” screen.

STEP 6 Choose the data to delete.

STEP 7 A confirmation message will be displayed. If everything is correct, touch **Yes**.

تلفن شماره روزی: +۲۱-۸۸۶۲۰۸۵

■ To delete all speed tone data

Follow the steps “Deleting a speed tone” to “STEP 5”. In the “Speed Tone” section, touch **Delete All**. A confirmation message will be displayed. If everything is correct, touch **Yes**.

Setting the volume

STEP 1 Press .

STEP 2 Touch  on the "Information" screen.

STEP 3 Touch  on the "Telephone" screen.

STEP 4 Touch  on the "Settings" screen.

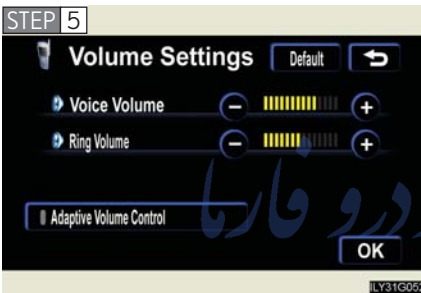

Touch  or  to lower or raise the volume.

• Voice Volume: Change the speaker volume

• Ring Volume: Change the ring volume

Adaptive volume control

When traveling at 50 mph (80 km/h) or over, the system automatically raises the volume one level.

If the vehicle's speed drops to 43 mph (70 km/h), the volume will return to its original level.

You can turn this function on/off by touching .

To return to the default volume settings

Touch , then .

تلفن شبانه روزی: ۰۲۱-۸۸۶۲۰۸۵

FarmaSOS.com

Changing the screen settings

STEP 1 Press .

STEP 2 Touch  on the “Information” screen.

STEP 3 Touch  on the “Telephone” screen.

STEP 4 Touch  on the “Settings” screen.

The following settings can be changed.

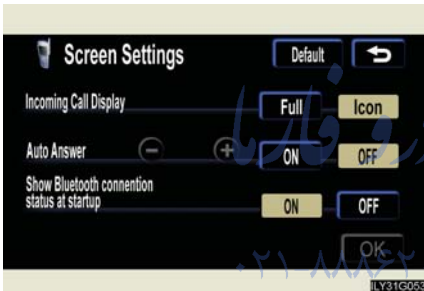

“Incoming Call Display”

The incoming call screen settings can be changed.

“Auto Answer”

When a call is received, the system automatically switches to the talking screen after the set period of time, meaning you can speak without pressing anything.

“Show Bluetooth* connection status at startup”

You can set the system to show the status confirmation display when connecting.

*: Bluetooth is a registered trademark of Bluetooth SIG, Inc.

■ “Incoming Call Display” settings

Select the desired switch.

Full : The hands-free screen is displayed when a call is received, and you can operate the system from that screen.

Icon : A message is displayed at the top of the screen, and you can only operate the system with the steering switches.

■ “Auto Answer” settings

STEP 1 Touch **ON**.

STEP 2 Set the wait time using **-** and **+**. (1- 60 seconds)

■ “Show Bluetooth* connection status at startup” settings

Touch **ON** / **OFF**.

*: Bluetooth is a registered trademark of Bluetooth SIG. Inc.

■ To set the screen settings to default

Touch **Default**, then **Yes**.

Phone book settings

Up to 1000 names, 2 items per name, can be registered.

■ Transferring mobile phone data

STEP 1 Press .

STEP 2 Touch  on the "Information" screen.

STEP 3 Touch  on the "Telephone" screen.

STEP 4 Touch  on the "Settings" screen.

STEP 5 Touch .

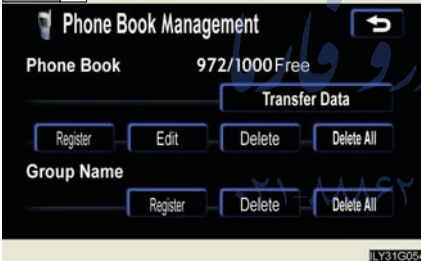

STEP 6 Select the group to transfer to.

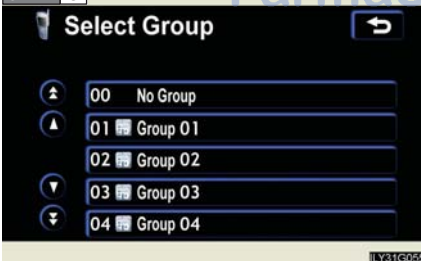

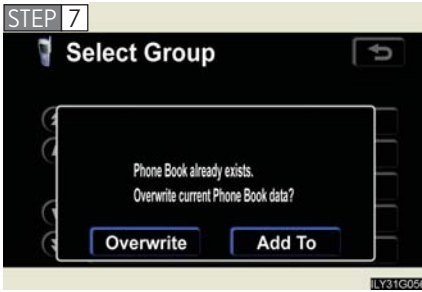

To overwrite data, touch **Overwrite**.

To add to existing data, touch **Add To**.

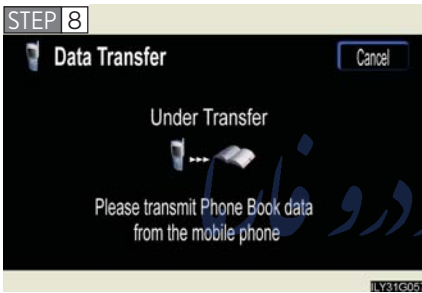

Transfer will begin. If you wish to cancel the transfer before finished, touch **Cancel**.

Transfer is complete when "Transfer completed" is displayed.

If "Transfer failed" is displayed, restart the process from the beginning.

■ Registering by input

STEP 1 Press **INFO** FarmaSOS.com

STEP 2 Touch **Telephone** on the "Information" screen.

STEP 3 Touch **Settings** on the "Telephone" screen.

STEP 4 Touch **Phone Book** on the "Settings" screen.

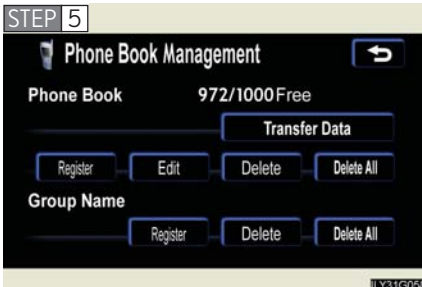

Touch the **Register** in the "Phone Book" section.

تلفن شبانه روزی: ۰۲۱-۸۸۶۲۰۸۵

3-4. Using the hands-free system (for cellular phone)

STEP 6 Choose the switch to register.

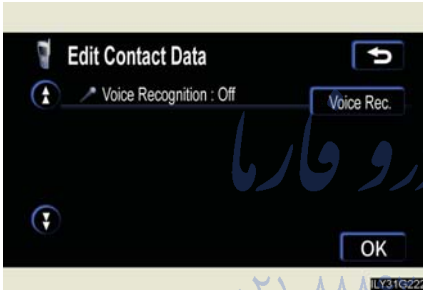
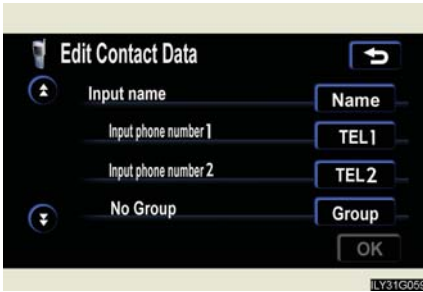

Name : Input the name on the “Name” screen.

TEL 1 , **TEL 2** :
Input the number(s) on the “Telephone Number” screen. When you touch **OK** , the “Select Icon” screen will appear. Choose the desired icon.

- **Mobile phone1**
- **Mobile phone2**
- **Home**
- **Work**
- **Other**

Group : Select the desired group from the “Select Group” screen. (No Group, 01-09)

Voice Rec. : Select the desired phone number and touch **REC** to record a voice tag.

To play the voice tag, touch **PLAY** . To delete the voice tag, touch **Delete** .

STEP 7 Once input is complete, touch **OK** .

■ Add history data to a registered entry

STEP 1 Press .

STEP 2 Touch  on the “Information” screen.

STEP 3 Touch  on the “Telephone” screen.

STEP 4 Choose the desired number from the list.

To choose from the received call history, touch  then select the desired number.

STEP 5 Touch .



STEP 6 Choose the phone book entry to be added to.

STEP 7 Check the data to be added, then touch .

FarmaSOS.com

3-4. Using the hands-free system (for cellular phone)

■ Editing phone book data

STEP 1 Press .

STEP 2 Touch  on the “Information” screen.

STEP 3 Touch  on the “Telephone” screen.

STEP 4 Touch  on the “Settings” screen.

STEP 5 Touch  in the “Phone Book” section of the “Phone Book Management” screen.

STEP 6 Choose the data to edit.

STEP 7 Choose the switch to edit.

STEP 8 After editing, touch .

■ Deleting phone book data

STEP 1 Press .

STEP 2 Touch  on the “Information” screen. تلفن شبانه

STEP 3 Touch  on the “Telephone” screen.



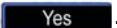

STEP 4 Touch  on the “Settings” screen.

STEP 5 Touch  in the “Phone Book” section of the “Phone Book Management” screen.

STEP 6 Select the data to delete.

STEP 7 A confirmation message will be displayed. If everything is correct, touch .

■ To delete all data

Follow the steps “Deleting phone book data” to “STEP 5”. In the “Phone Book” section of the “Phone Book Management” screen, touch . To delete all data within a group, touch , then select the group to delete. To delete all contact data, touch . Check that everything is correct, then touch .

■ Registering/Editing/Deleting from the phone book

You can register data in the phone book, edit registered data, and delete items.

STEP 1 Press .

STEP 2 Touch  on the “Information” screen.

STEP 3 Touch  on the “Telephone” screen.

STEP 4 To register data, touch  on the “Phone Book” screen.

To delete all data, touch .

To delete or edit specific data, select the data to delete/edit, then touch

 to delete, or  to edit. *تلفن شیانہ*

■ The phone book

The method for transferring phone book data from the phone to the system varies with phone model. See the phone’s manual.

Changing the phone book group name settings

■ Registering a group name

STEP 1 Press .

STEP 2 Touch  on the “Information” screen.

STEP 3 Touch  on the “Telephone” screen.

STEP 4 Touch  on the “Settings” screen.

STEP 5 Touch the  switch in the “Group Name” section of the “Phone Book Management” screen.

STEP 6 Select the group to register (“01” - “19”).

STEP 7 Select the switch to be edited.

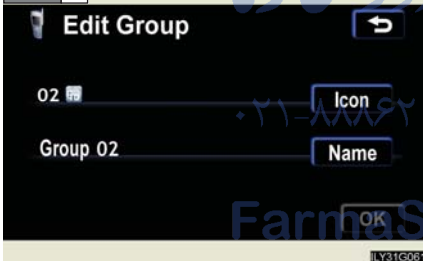

Icon : The below screen will be displayed. Select the desired icon.

Name : Input the name on the “Name” screen.



STEP 8 Once editing is complete, touch .

■ Deleting a group name

STEP 1 Press .

STEP 2 Touch  on the “Information” screen.

STEP 3 Touch  on the “Telephone” screen.



STEP 4 Touch  on the “Settings” screen.

STEP 5 Touch  in the “Group Name” section of the “Phone Book Management” screen.

STEP 6 Select the group name to delete.

STEP 7 A confirmation message will be displayed. If everything is correct, touch .

■ To delete all data

Follow the steps “Deleting phone book data” procedure to “STEP 5”. In the “Phone Book” section of the “Phone Book Management” screen, touch . A confirmation message will be displayed. If everything is correct, touch .

FarmaSOS.com

Deleting the history

STEP 1 Press .

STEP 2 Touch  on the "Information" screen.

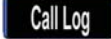
STEP 3 Touch  on the "Telephone" screen.

STEP 4 Select the data to delete from the list.

To delete data from the received calls history, touch , then select the data to delete.

STEP 5

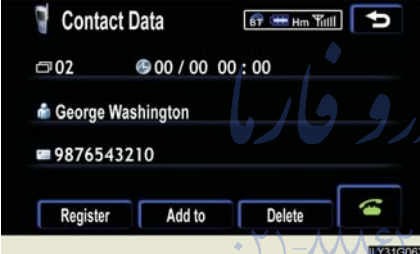



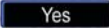

Touch .

STEP 6 Check that everything is correct, then touch .

FarmaSOS.com

■ To delete all data

Follow the steps "Deleting a group name" to "STEP 4". Touch  on the "Outgoing Calls" screen. To delete all received call history data, touch , then touch . Check that everything is correct, then touch .

Changing the security settings

You can disable certain hands-free system functions. Use the security settings when you do not wish other people to see the registered data, for example when having the vehicle valet parked at a hotel.

To enable or disable security, the security code (4 digits) is required. The default code is "0000". Be sure to change the security code before use.

■ Changing the security code

STEP 1 Press .

STEP 2 Touch  on the "Information" screen.

STEP 3 Touch  on the "Telephone" screen.

STEP 4 Touch  on the "Settings" screen.

STEP 5 Touch  in the "Security Code" section.

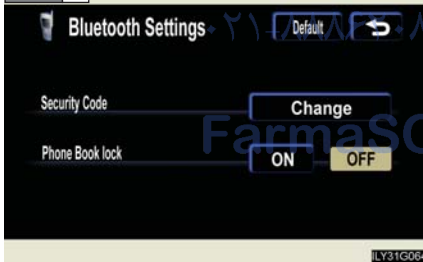

3-4. Using the hands-free system (for cellular phone)

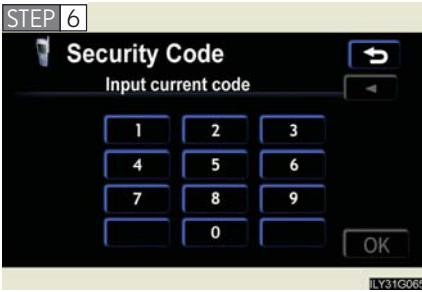

Input the current security code, and touch **OK**.

STEP 7 Input the new security code, and touch **OK**.

STEP 8 A confirmation message will appear. If everything is correct, touch **Yes**.

■ Enabling security

STEP 1 Press **INFO**.

STEP 2 Touch **Telephone** on the "Information" screen.

STEP 3 Touch **Settings** on the "Telephone" screen.

STEP 4 Touch **Phone Book Lock** on the "Settings" screen.

STEP 5 Touch **ON** in the "Phone Book Lock" section of the "Phone Book Lock" screen.

STEP 6 Input the security code, and touch **OK**.

■ Setting the security code to default

STEP 1 Press .

STEP 2 Touch  on the “Information” screen.

STEP 3 Touch  on the “Telephone” screen.

STEP 4 Touch  on the “Settings” screen.

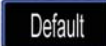
STEP 5 Touch  on the “Phone Book Lock” screen.

STEP 6 Input the security code on the “Security Code” screen, then touch .

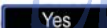
STEP 7 A confirmation message will appear. If everything is correct, touch .

تلفن شبانه روزی: ۰۲۱-۸۸۶۲۰۸۵

FarmaSOS.com

■ If the “Phone Book Lock” is set

If the security code is input and the “Phone Book Lock” set, the following functions are locked.

- Display of the phone book screen and transferring, registering, editing, deleting the phone book data.
- Display of speed dial screen, registering, deleting the speed dial and speed dialing.
- Display of the other party’s name for calls being received or made.
- Display of dialed numbers screen and received calls screen, deleting dialed numbers and received numbers.
- Display of phone information screen.
- Changing the security code.

The speed dial screen is not displayed while driving.

■ When changing the security code

- Be sure to choose a number difficult for strangers to guess.
- Do not forget the security code. Even your Lexus dealer will be unable to disable the security. If you do forget the code, initialize all personal data. (→P. 215)

FarmaSOS.com

Setting a Bluetooth® phone

■ Selecting a Bluetooth® phone

If multiple Bluetooth® phones are registered, follow the below procedure to select the Bluetooth® phone to be used. You may only use one phone at a time.

STEP 1 Press .

STEP 2 Touch  on the “Information” screen.

STEP 3 Touch  on the “Telephone” screen.

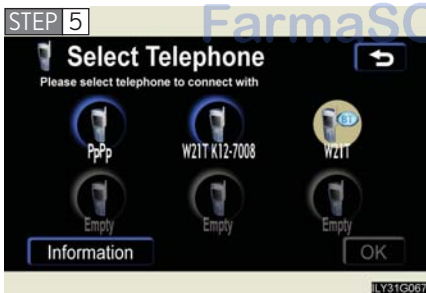
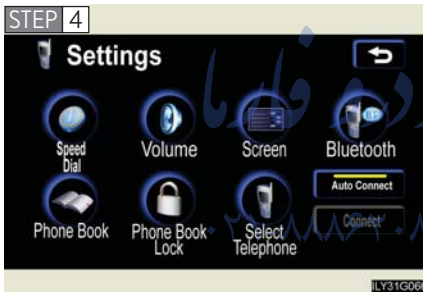

STEP 4 Touch .



Select the phone to be use, then touch .

If no phones are registered, “Empty” will be displayed.

If “Bluetooth* connection successful” is displayed, registration was successful.

If another Bluetooth® phone is already connected, a confirmation message is displayed. Touch  or .

*: Bluetooth is a registered trademark of Bluetooth SIG. Inc.

■ Displaying Bluetooth® information

You can check the device address and device name.

STEP 1 Press .

STEP 2 Touch  on the “Information” screen.

STEP 3 Touch  on the “Telephone” screen.

STEP 4 Touch  on the “Settings” screen.

STEP 5 On the “Select Telephone” screen, select the desired phone and touch .

STEP 6



To change the device name, touch  in the “Device Name” section, and input the name on the “Name” screen (max. 20 characters).

تلفن شبانه روزی: ۰۲۱-۸۸۶۲۰۸۵

■ To change the Bluetooth® settings

You can change the device name and passkey.

STEP 1 Press .

STEP 2 Touch  on the “Information” screen.

STEP 3 Touch  on the “Telephone” screen.

STEP 4 Touch  on the “Settings” screen.



To change the device name, touch **Change** in the “Device Name” section, and input the name on the “Name” screen (max. 20 characters).

To change the passkey, touch **Change** in the “Passkey” section, and input 4 - 8 digits on the “Passkey” screen.

■ Setting the Bluetooth® settings to default

STEP 1 Press **INFO**.

STEP 2 Touch **Telephone** on the “Information” screen.

STEP 3 Touch **Settings** on the “Telephone” screen.

STEP 4 Touch **Bluetooth** on the “Settings” screen. *تلفن شبانه*

STEP 5 Touch **Default** on the “Bluetooth* Settings” screen.

STEP 6 A confirmation message is displayed. If everything is correct, touch **Yes**.

*: Bluetooth is a registered trademark of Bluetooth SIG, Inc.

■ To delete the Bluetooth® settings

STEP 1 Press .

STEP 2 Touch  on the “Information” screen.



STEP 3 Touch  on the “Telephone” screen.

STEP 4 Touch  on the “Settings” screen.

STEP 5 Touch  in the “Bluetooth* Telephone” section of the “Bluetooth* Settings” screen.

STEP 6 On the “Delete Telephone” screen, select the phone to delete.

To check the device address, touch .

STEP 7 If you touch , a confirmation message is displayed. If everything is correct, touch .

*: Bluetooth is a registered trademark of Bluetooth SIG. Inc.

تلفن شبانه روزی: ۰۲۱-۸۸۶۲۰۸۵

FarmaSOS.com

3-5. Using the interior lights

Interior lights list

Illuminated entry system: The various lights automatically turn on/off according to the presence of the electronic key, whether the doors are locked/unlocked, whether the doors are open/closed, and the "ENGINE START STOP" switch mode.

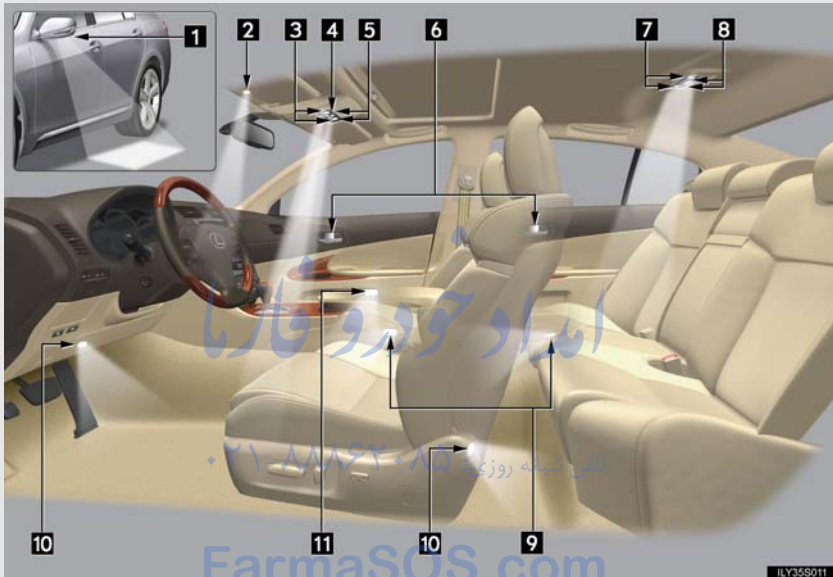

- | | |
|---|--|
| 1 Outer foot light | 7 Rear personal lights
(→P. 339) |
| 2 Steering spot light | 8 Rear interior lights |
| 3 Front personal lights
(→P. 339) | 9 Door courtesy lights |
| 4 Shift lever light | 10 Foot light |
| 5 Front interior lights(→P. 338) | 11 Front scuff light |
| 6 Inside door handle lights | |

When the instrument panel light control switch is turned to minimum, the foot lights, inside door handle lights and shift lever light will turn off. (→P. 133)

■ To prevent 12 volt battery discharge

If the interior lights, personal lights and steering spot light remain ON when the door is not fully closed or the interior light switch in "DOOR" position, the lights will go off automatically after 20 minutes.

■ Customization that can be configured at Lexus dealer

Setting (e.g. The time elapsed before lights turn off) can be changed.
(Customizable features →P. 573)

Interior lights



- 1 "ON"
- 2 "OFF"
- 3 "DOOR"

The interior lights are turned on/off by the illuminated entry system.

تلفن شبانه روزی: ۰۲۱-۸۵۰۰۰۰۰۰۰۰

FarmaSOS.com

Personal lights

► Front



ON/OFF

► Rear



ON/OFF

■ Customization that can be configured at Lexus dealer

Settings can be changed. (Customizable features →P. 573)

3-6. Using the storage features

List of storage features

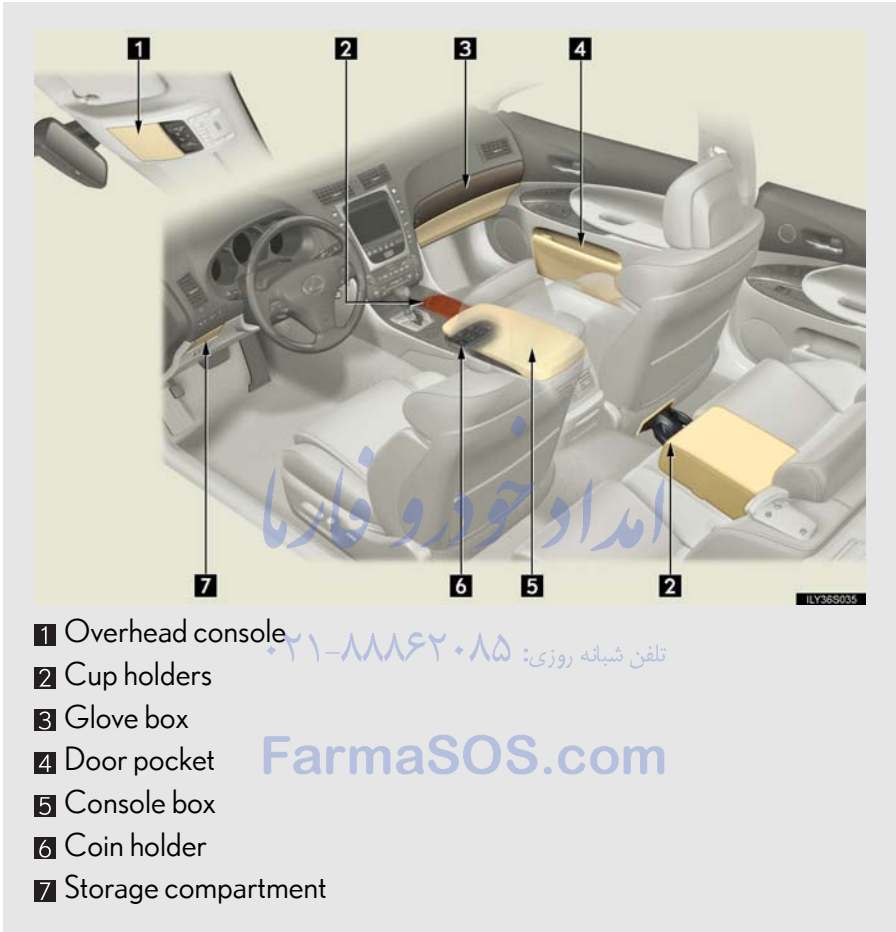

Glove box

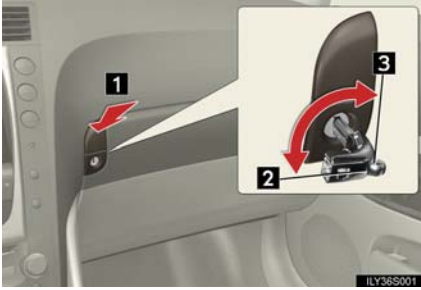

- 1 Open (push button)
- 2 Unlock with the mechanical key
- 3 Lock with the mechanical key

■ Glove box light

The glove box light turns on when the headlight switch is on.

■ Trunk opener main switch

The trunk opener main switch is located in the glove box. (→P. 42)

⚠ CAUTION

■ While driving

Keep the glove box closed.

Injuries may result in the event of an accident or sudden braking.

Console box

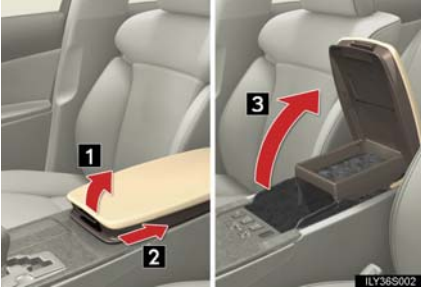

- 1 Pull up the lever to release the lock.
- 2 Slide armrest.
- 3 Lift the armrest to open.

■ Console box light

The console box light turns on when the headlight switch is on.

⚠ CAUTION

■ While driving

Keep the console box closed.

Injuries may result in the event of an accident or sudden braking.

امداد خودرو فارما
تلفن شبانه روزی: ۰۲۱-۸۸۶۲۰۸۵
FarmaSOS.com

Overhead console (if equipped)

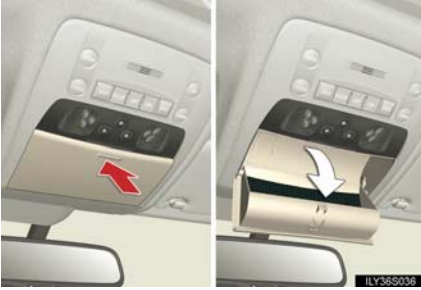

The overhead console is useful for temporarily storing sunglasses and similar small items.

! CAUTION

■ Items that should not be left in the overhead console

Do not leave glasses or lighters in the console.

If the interior of the vehicle becomes hot, lighters may explode and glasses may warp or become cracked.

■ While driving

Do not leave the overhead console open. Items may fall out and cause injury.

Storage compartment



⚠ CAUTION

■ While driving

Do not leave the storage compartment open.

The opened compartment may hit your body or items may be thrown out of the compartment in the event of an accident or sudden braking and cause injury.

امداد خودرو فارما
تلفن شبانه روزی: ۰۲۱-۸۸۶۳۰۸۵

FarmaSOS.com

Coin holder

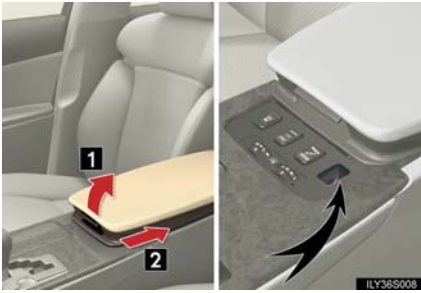

- 1 Pull up lever to release the lock.
- 2 Slide armrest.

Cup holders

► Front

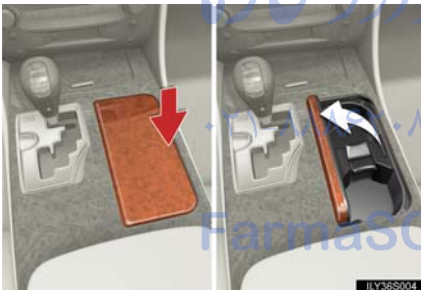

To open, press down and release the cup holder lid.

► Rear

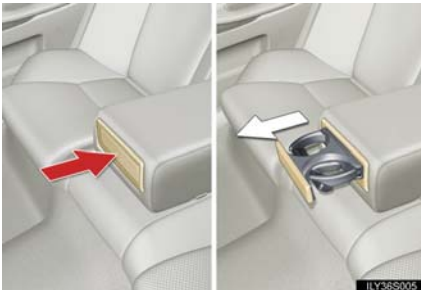

To open, press in and release the rear cup holder on the armrest.

⚠ CAUTION

■ **Items unsuitable for the cup holder**

Do not place anything other than cups or aluminum cans in the cup holders. Other items may be thrown out of the holders in the event of an accident or sudden braking and cause injury. If possible, cover hot drinks to prevent burns.

■ **When not in use**

Keep the cup holders closed. Injuries may result in the event of an accident or sudden braking.

Door pockets



The front door pocket can be opened and closed.

⚠ CAUTION

■ **While driving**

Keep the door pockets closed. Injuries may result in the event of an accident or sudden braking.

3-7. Other interior features

Sun visors

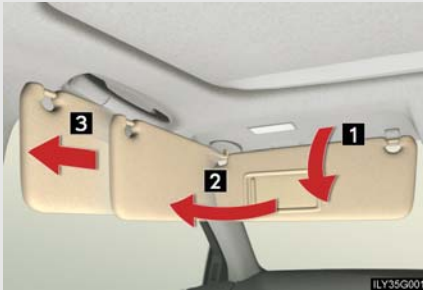

- 1 Forward position: Flip down.
- 2 Side position: Flip down, unhook, and swing to the side.
- 3 Side extender: Place in side position, then slide backwards.

امداد خودرو فارما

تلفن شبانه روزی: ۰۲۱-۸۸۶۲۰۸۵

FarmaSOS.com

3-7. Other interior features

Vanity mirror



Slide the cover.

The light turns on when the cover is opened.

امداد خودرو فارما

تلفن شبانه روزی: ۰۲۱-۸۸۸۶۲۰۸۵

FarmaSOS.com

3-7. Other interior features

Clock



■ Adjust clock

- ▶ With navigation system
→ “Navigation System Owner’s Manual”.
- ▶ Without navigation system
Perform the following steps.

STEP 1 Press **INFO**.

STEP 2 Touch **Adjust Clock**.

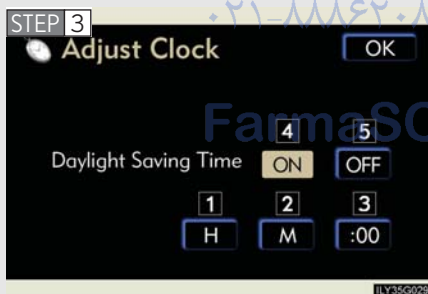

1 Adjust hours.

2 Adjust minutes.

3 Round the nearest hour.

4 Turn daylight saving time on.

5 Turn daylight saving time off.

After setting, touch **OK**.

■ The clock is displayed when

The “ENGINE START STOP” switch is in ACCESSORY or IGNITION ON mode.

■ When the 12 volt battery is disconnected

The time display will automatically be set to 1:00.

3-7. Other interior features

Outside temperature display

The displayed temperature ranges from -40°F (-40°C) up to 122°F (50°C).



■ The outside temperature is displayed when

The "ENGINE START STOP" switch is in IGNITION ON mode.

■ When "--" or "E" is displayed

The system may be malfunctioning. Take your vehicle to your Lexus dealer.

■ On the multi-information display

→P.140

■ Display

In the following situations, the correct outside temperature may not be displayed, or the display may take longer than normal to change.

- When stopped, or driving at low speeds (less than 12 mph [20 km/h])
- When the outside temperature has changed suddenly (at the entrance/exit of a garage, tunnel, etc.)

3-7. Other interior features

Ashtrays

► Front



Slide the lid to open.

Push the lever to remove the ashtray.

Push the lid to close.

► Rear



Pull the lid to open.

Hold the plate down and pull the ashtray upwards to remove.

FarmaSOS.com

! CAUTION

■ When not in use

Keep the ashtray closed.

Injuries may result in the event of an accident or sudden braking.

■ To prevent fire

- Fully extinguish matches and cigarettes before putting them in the ashtray, then make sure the ashtray is fully closed.
- Do not place paper or any other type of flammable object in the ashtray.

3-7. Other interior features

Cigarette lighter



- 1 Slide the lid to open, and push the cigarette lighter down.

The cigarette lighter will pop up when ready for use.

■ The cigarette lighter can be used when

The "ENGINE START STOP" switch is in ACCESSORY or IGNITION ON mode.

⚠ CAUTION

■ To avoid burns or fires

- Do not touch the metal parts of the cigarette lighter.
- Do not hold the cigarette lighter down. It could overheat and cause a fire.
- Do not insert anything other than the cigarette lighter into the outlet.

■ When not in use

Keep the ashtray lid closed.

Injuries may result in the event of an accident or sudden braking.

3-7. Other interior features

Power outlet

The power outlet can be used for 12V accessories that run on less than 10A.



■ The power outlet can be used when

The "ENGINE START STOP" switch is in ACCESSORY or IGNITION ON mode.

⚠ NOTICE

تلفن شبانه روزی: ۰۲۱-۸۸۶۲۰۸۵

■ To avoid damaging the power outlet

Close the power outlet lid when not in use.
Foreign objects or liquids that enter the power outlet may cause a short circuit.

■ To prevent the fuse from being blown

Do not use an accessory that uses more than 12V/10A.

■ To prevent 12 volt battery discharge

Do not use the power outlet longer than necessary when the engine is off.

3-7. Other interior features

Seat heaters/ventilators (if equipped)

The temperature of the seats can be adjusted individually.

■ Seat heaters



1 Heats the seats

The indicator light comes on.
The higher the number, the warmer the seats become.

■ Seat heaters/ventilators

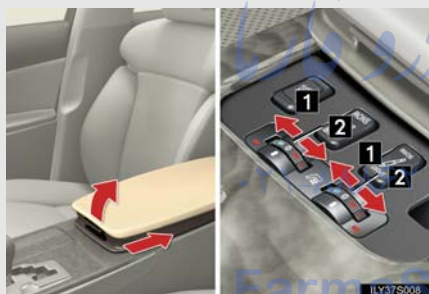

1 Heats the seats

The indicator light (red) comes on.
The higher the number, the warmer the seats become.

2 Blows air from the seats

The indicator light (green) comes on.
The higher the number, the stronger the airflow becomes.

■ The seat heaters/ventilators can be used when

The "ENGINE START STOP" switch is in IGNITION ON mode.

■ When not in use

Set the dial to "0". The indicator light turns off.

CAUTION**Burns**

- Use caution when seating the following persons in a seat with the seat heater on to avoid the possibility of burns:
 - Babies, small children, the elderly, the sick and the disabled
 - Persons with sensitive skin
 - Persons who are fatigued
 - Persons who have taken alcohol or drugs that induce sleep (sleeping drugs, cold remedies, etc.)
- Do not cover the seat with anything when using the seat heater. Using the seat heater with a blanket or cushion increases the temperature of the seat and may lead to overheating.

NOTICE**To prevent damage to the seat heaters/ventilators**

Do not put heavy objects on the seat and do not stick sharp objects (needles, nails, etc.) into the seat.

To prevent 12 volt battery discharge

Turn the switches off when the engine is off.

3-7. Other interior features

Armrest



Pull the armrest down for use.

NOTICE

■ **To prevent damage to the armrest**

Do not place too much strain on the armrest.

تلفن شبانه روزی: ۰۲۱-۸۸۶۲۰۸۵

FarmaSOS.com

3-7. Other interior features

Rear sunshade (if equipped)

The rear sunshade can be raised and lowered by pressing the switch shown below.

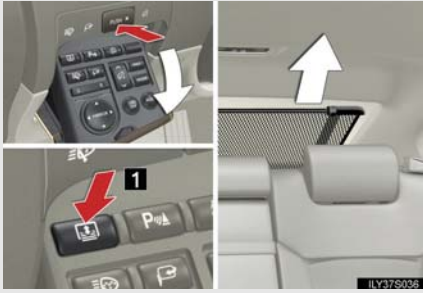

1 Raise/lower

■ The rear sunshade can be used when

The “ENGINE START STOP” switch is in IGNITION ON mode.

■ Reverse operation feature

To ensure adequate rear visibility, the sunshade automatically lowers when the shift lever is shifted to “R”.

However, the rear sunshade is raised again if any of the following occurs:

- Shift the shift lever into “P”.
- The switch is pressed again.
- The shift lever is shifted out of “R”, and the vehicle reaches a speed of 9 mph (15 km/h).

If the engine is turned off when the rear sunshade has been lowered due to the reverse operation feature, it will not be raised even when the engine is turned on again and the vehicle reaches a speed of 9 mph (15 km/h). To raise the sunshade again, press the switch.

■ After the “ENGINE START STOP” switch is turned to OFF

The rear sunshade can be raised and lowered for approximately 1 minute.

 **CAUTION**

■ **When the rear sunshade is being raised or lowered**

Do not place fingers or other objects in the fastener section or in the opening. They may get caught, causing injury.

 **NOTICE**

■ **To prevent 12 volt battery discharge**

Do not operate the rear sunshade when the engine is off.

■ **To ensure normal operation of the sunshade**

Observe the following precautions.

- Do not place excessive load on the motor or other components.
- Do not place objects where they may hinder opening and closing operations.
- Do not attach items to the rear sunshade.
- Keep the opening clean and clear of obstructions.
- Do not operate the rear sunshade continuously over long periods of time.

FarmaSOS.com

3-7. Other interior features

Floor mats

Securely place a mat that matches the size of the space on the carpet.

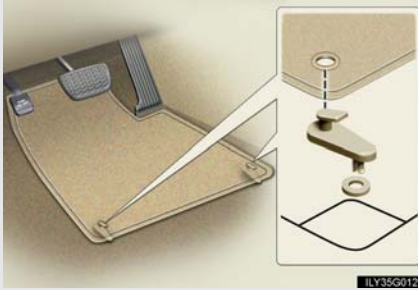

Secure the floor mat using the hooks provided.

CAUTION

■ When inserting the floor mat

Observe the following precautions.

Failure to do so may result in the floor mat slipping and interfering with the movement of the pedals during driving, resulting in an accident.

- Make sure the floor mat is properly placed on the vehicle carpet and the correct side face upward.
- Do not place floor mats on the top of existing mats.

3-7. Other interior features

Trunk features

■ Cargo hooks



Cargo hooks are provided for securing loose items.

■ Shopping bag hooks



■ First-aid kit storage belt



- 1 Loosen
- 2 Tighten

■ Luggage mat



Pull the lever upwards when lifting the luggage mat up.

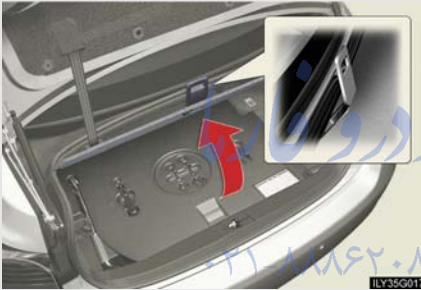

The lever can be hooked on the edge of the trunk.

Trunk storage extension

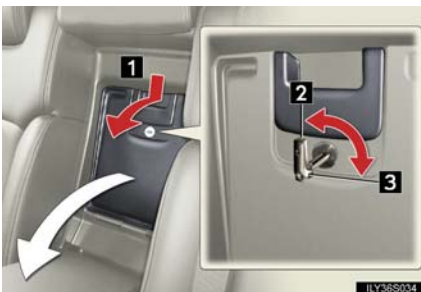

Pull down the rear armrest.

- 1** Open (push down the handle)
- 2** Unlock with the mechanical key
- 3** Lock with the mechanical key

 CAUTION

■ While driving

- To avoid injury, always return the cargo hooks to their positions when they are not in use.
- Always keep the trunk storage extension door closed to reduce the chance of injury in case of an accident or sudden stop.

 NOTICE

■ When closing the trunk

Do not leave the luggage mat lever hooked on the edge of the trunk.
The luggage mat may get damaged.

امداد خودرو فارما
تلفن شبانه روزی: ۰۲۱-۸۸۶۲۰۸۵

FarmaSOS.com

3-7. Other interior features

Garage door opener

The garage door opener can be programmed to operate garage doors, gates, entry doors, door locks, home lighting systems, and security systems, and other devices.

The garage door opener (HomeLink® Universal Transceiver) is manufactured under license from HomeLink®.

Programming the HomeLink® (for U.S.A. owners)

The HomeLink® compatible transceiver in your vehicle has 3 buttons which can be programmed to operate 3 different devices. Refer to the programming method below appropriate for the device.

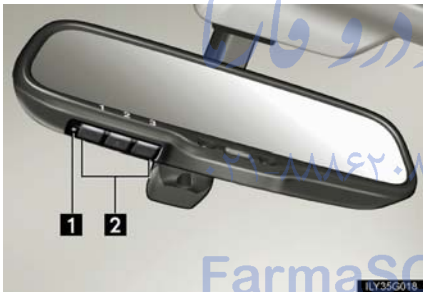

- 1 Indicator
- 2 Buttons

■ Programming the HomeLink®



Point the remote control for the device 1 to 3 in. (25 to 75 mm) from the HomeLink® control buttons.

Keep the indicator light on the HomeLink® in view while programming.

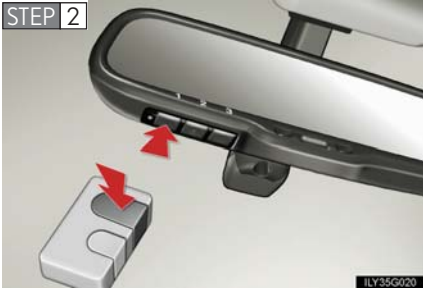

Press and hold one of the buttons on the HomeLink[®] and the button on the transmitter. When the indicator light on the HomeLink[®] changes from a slow to a rapid flash after 20 seconds, you can release both buttons.

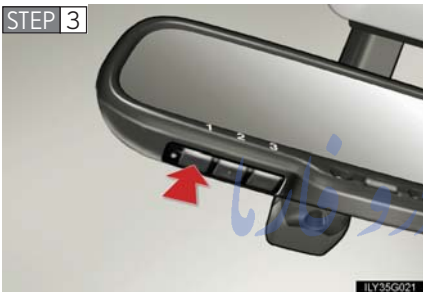

Test the operation of the HomeLink[®] by pressing the newly programmed button.

If programming a garage door opener, check to see if the garage door opens and closes. If the garage door does not operate, see if your garage transmitter is of the Rolling Code type. Press and hold the programmed HomeLink[®] button. The garage door has the rolling code feature if the indicator light (on the HomeLink[®]) flashes rapidly for 2 seconds and then remains lit. If your transmitter is the Rolling Code type, proceed to the heading "Programming a rolling code system".

STEP 4 Repeat the steps above to program another device for each of the remaining HomeLink[®] buttons.

■ Programming a Rolling Code system (for U.S.A. owners)

If your device is Rolling Code equipped, follow the steps under the heading “Programming the HomeLink[®]” before proceeding with the steps listed below.

STEP 1 Locate the training button on the ceiling mounted garage door opener motor. The exact location and color of the button may vary by brand of garage door opener.

Refer to the operation manual supplied with the garage door opener for the location of the training button.

STEP 2 Press the training button.

STEP 3 Press and release the vehicle’s programmed HomeLink[®] button twice. The garage door may open.

If the garage door opens, the programming process is complete. If the door does not open, press and release the button a third time. This third press and release will complete the programming process by opening the garage door.

The ceiling mounted garage door opener motor should now recognize the HomeLink[®] transceiver and operate the garage door.

STEP 4 Repeat the steps above to program another rolling code system for any of the remaining HomeLink[®] buttons.

■ Programming an entry gate (for U.S.A. owners)/Programming all devices in the Canadian market

STEP 1 Place your transmitter 1 to 3 in. (25 to 75 mm) away from the surface of the HomeLink[®].

Keep the indicator light on the HomeLink[®] in view while programming.

STEP 2 Press and hold the selected HomeLink[®] button.

STEP 3 Repeatedly press and release (cycle) the device's remote control button for two seconds each until step 4 is completed.

STEP 4 When the indicator light on the HomeLink[®] compatible transceiver starts to flash rapidly, release the buttons.

STEP 5 Test the operation of the HomeLink[®] by pressing the newly programmed button. Check to see if the gate/device operates correctly.

STEP 6 Repeat the steps above to program another device for each of the remaining HomeLink[®] buttons.

■ Programming other devices

To program other devices such as home security systems, home door locks or lighting, contact your authorized Lexus dealer for assistance.

■ Reprogramming a button

The individual HomeLink[®] buttons cannot be erased but can be reprogrammed. To reprogram a button, follow the "Basic programming" instructions.

Operating the HomeLink®

Press the appropriate HomeLink® button. The HomeLink® indicator light on the HomeLink® transceiver should turn on.

The HomeLink® continues to send a signal for up to 20 seconds as long as the button is pressed.

Erasing the entire HomeLink® memory (all three programs)

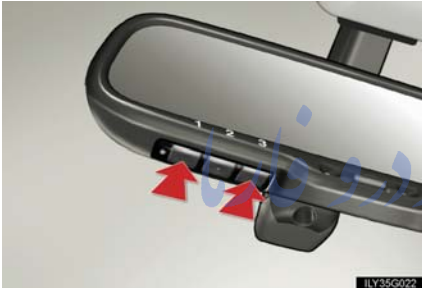

Press and hold the 2 outside buttons for 20 seconds until the indicator light flashes.

If you sell your vehicle, be sure to erase the programs stored in the HomeLink® memory.

تلفن شبانه روزی: ۰۲۱-۸۸۶۲۰۸۵

■ Before programming

- Install a new battery in the transmitter.
- The battery side of the transmitter must be pointed away from the HomeLink®.

■ Certification for the garage door opener

This device complies with Part 15 of the FCC Rules and with RSS-210 of the IC Rules.

Operation is subject to the following two conditions: (1) this device may not cause harmful interference, and (2) this device must accept any interference received, including interference that may cause undesired operation.

WARNING: This transmitter has been tested and complies with FCC and IC rules. Changes or modifications not expressly approved by the party responsible for compliance could void the user's authority to operate the device.

 CAUTION

■ **When programming a garage door or other remote control device**

The garage door may operate, so ensure people and objects are out of danger to prevent potential harm.

■ **Conforming to federal safety standards**

Do not use the HomeLink® Compatible Transceiver with any garage door opener or device that lacks safety stop and reverse features as required by federal safety standards.

This includes any garage door that cannot detect an obstruction object. A door or device without these features increases the risk of death or serious injury.

امداد خودرو فارما

تلفن شبانه روزی: ۰۲۱-۸۸۶۲۰۸۵

FarmaSOS.com

3-7. Other interior features

Compass

The compass on the inside rear view mirror indicates the direction in which the vehicle is heading.

■ Operation



To turn the compass on or off, press "AUTO" for 3 seconds.

■ Displays and directions

Display	Direction
N	North
NE	Northeast
E	East
SE	Southeast
S	South
SW	Southwest
W	West
NW	Northwest

Calibrating the compass

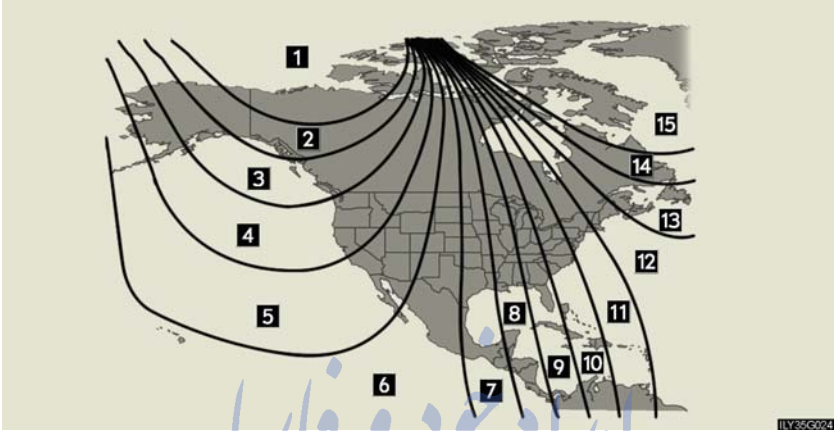

The direction display deviates from the true direction determined by the earth's magnetic field. The amount of deviation varies according to the geographic position of the vehicle.

If you cross over a map boundary shown in illustration, the compass will deviate.

To obtain higher precision or perfect calibration, refer to the following.

■ Deviation calibration

STEP 1 Stop the vehicle where it is safe to drive in a circle.

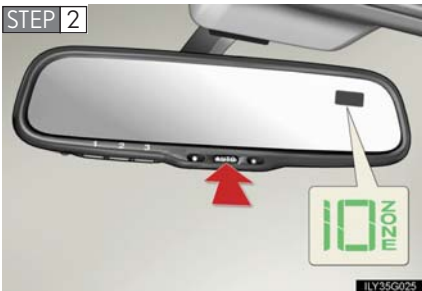

Press "AUTO" until a number (1 to 15) appears on the compass display.

STEP 3 Press "AUTO", and referring to the map above, select the number of the zone where you are.

STEP 4 Wait a few seconds until the compass direction is displayed.

The calibration is complete.

■ Circling calibration



If "CAL" appears on the display, drive the vehicle at 5 mph (8 km/h) or less in a circle until a direction is displayed.

If there is not enough space to drive in a circle, drive around the block until the direction is displayed.

■ Conditions unfavorable to correct operation

The compass may not show the correct direction in the following conditions:

- The vehicle is stopped immediately after turning.
- The vehicle is on an inclined surface.
- The vehicle is in a place where the earth's magnetic field is subject to interference by artificial magnetic fields (underground car park/parking lot, under a steel tower, between buildings, roof car park/parking lot, near an intersection, near a large vehicle, etc.).
- The vehicle has become magnetized.
(There is a magnet or metal object near the inside rear view mirror.)
- The 12 volt battery has been disconnected.
- A door is open.

 CAUTION

■ **While driving**

Do not adjust the display.

Be sure to adjust the display only when the vehicle is stopped.

■ **When doing the circling calibration**

Be sure to secure a wide space, and watch out for people and vehicles in the neighborhood. Do not violate any local traffic rules while performing circling calibration.

 NOTICE

■ **To avoid the compass malfunctions**

Do not place magnets or any metal objects near the inside rear view mirror.

Doing this may cause a malfunction of the compass sensor.

■ **To ensure normal operation of the compass**

● Do not perform circling calibration of the compass in a place where the earth's magnetic field is subject to interference by artificial magnetic fields.

● During calibration, do not operate electric systems (moon roof, power windows, etc.) as they may interfere with the calibration.

FarmaSOS.com

3-7. Other interior features

Lexus Link System (if equipped)

The Lexus Link System is a communication service that uses Global Positioning System (GPS) data and cellular service to provide you with safety, security and convenience. This system is only operational in GPS and cellular coverage areas. Button operation and voice commands are used to operate the system. To operate the system, follow the voice guidance instructions. For details about service and subscription, call the Lexus Link Call Center at 1-800-25-LEXUS (1-800-255-3987) (toll-free).

■ Buttons



- 1 Voice keypad button
- 2 Volume control
- 3 Phone button
- 4 "SERVICES" button
- 5 Emergency button

■ Services

The Lexus Link System offers the following services.

- Airbag deployment notification (→P. 375)
- Emergency assistance (→P. 375)
- Stolen vehicle location assistance (→P. 376)
- Remote horn/lights and remote door lock/unlock (→P. 376)
- Advisor record (→P. 377)
- Personal calling (→P. 377)
- Other services (→P. 376)

Operating the Lexus Link System during a Bluetooth® phone call will terminate the Bluetooth® phone call.

Safety information for the Lexus Link System

Important! Read this information before using the Lexus Link System.

■ Exposure to radio frequency signals

The Lexus Link System installed in your vehicle is a low power radio transmitter and receiver. When the “ENGINE START STOP” switch is in the IGNITION ON mode, it receives and also sends radio frequency (RF) signals.

In August 1996, the Federal Communications Commission (FCC) adopted RF exposure guidelines with safety levels for mobile wireless phones. Those guidelines are consistent with the safety standards previously set by both U.S. and international standards bodies.

- ANSI (American National Standards Institute) C95.1 [1992]
- NCRP (National Council on Radiation Protection and Measurement) Report 86 [1986]
- ICNIRP (International Commission on Non-Ionizing Radiation Protection) [1996]

Those standards were based on comprehensive and periodic evaluations of the relevant scientific literature. Over 120 scientists, engineers, and physicians from universities, government health agencies, and industry reviewed the available body of research to develop the ANSI Standard (C95.1).

The design of the Lexus Link System complies with the FCC guidelines in addition to those standards.

Indicator and warning lights



1 Operation indicator light

If your subscription has expired, the operation indicator light will go off.

2 Warning light

If the warning light (red light) comes on, have the vehicle inspected by your Lexus dealer.

Airbag deployment notification

If an airbag deploys, an emergency call is automatically placed to the Lexus Link Call Center, and your vehicle's location is identified. The Lexus Link Advisor will attempt to contact you and assess the situation. The Advisor can quickly contact the nearest emergency services provider, describe the situation and request that assistance be sent to your location.

The Lexus Link Advisor can, if requested, connect you to an emergency services operator.

FarmaSOS.com

Emergency assistance

When you press the  button, a priority call is placed to the Lexus Link Call Center with your vehicle's location. At the Call Center, the Lexus Link Advisor can determine your vehicle's location, communicate with you, and, if appropriate, contact the nearest emergency service provider.

If you have accidentally pressed the button, tell the Lexus Link Advisor that you are not experiencing an emergency.

Stolen vehicle location assistance

If your vehicle is stolen, call the Lexus Link Call Center at 1-800-25-LEXUS (1-800-255-3987) (toll-free) and select the option for Lexus Link.

To protect subscribers' privacy, the location of a vehicle will not be provided to anyone other than a law enforcement authority.

Remote horn/lights and remote door lock/unlock

The remote operations are performed by contacting the Lexus Link Call Center from the outside of the vehicle. When necessary, call the Lexus Link Call Center at 1-800-25-LEXUS (1-800-255-3987) (toll-free) and select the option for Lexus Link.

- In the case that you forget to lock the vehicle or you are locked out, the Lexus Link Call Center can send a signal to lock or unlock the vehicle remotely.
- In the case that you forget where you parked the vehicle, such as in a large parking lot, the Lexus Link Call Center can send a signal to flash the headlights and sound the horn to help you locate the vehicle.



When contacting the Lexus Link Call Center from the outside of the vehicle, you need the Lexus Link PIN (Personal Identification Number). Write the PIN down and carry it with you.

Other services

Press the  button in the vehicle or call the Lexus Link Call Center at 1-800-25-LEXUS (1-800-255-3987) (toll-free), and then select the option for Lexus Link. The services provided will depend on the service plan level.

Advisor record

■ Recording a conversation with an advisor

Press the  button to record a conversation. To stop recording, press the  button again.

- Up to 2 minutes of recording time is available.
- Recording a new conversation deletes the previously recorded conversation.

■ Playing the recorded conversation

STEP 1 Press the  or  button.

STEP 2 Say “Advisor playback”.

Press the button again to stop the playback.

To restart the playback, press the  button, say “Advisor playback” and then select either of the following methods.

- Say “Resume” to resume the playback.
- Say “Play” to start from the beginning.

Personal calling

The hands-free personal calling feature can be added to the Lexus Link System as an option. You can purchase a package of minutes that works best for you. As you make and receive calls, minutes are deducted from your plan. They are easily billed to a credit card that is kept on file so no separate phone bill is needed.

Personal calling universal voice recognition commands:

- **“Help”** The system will provide a list of available commands.
- **“Clear”** When you are entering digits, this command will erase the last digit entered.
- **“Cancel”** This command takes you from the current function to the “Lexus Link ready” prompt. If the last response from the system was “Lexus Link ready”, this command will exit voice mode.

Voice recognition error message:

- **“Pardon”** The system responds with this message if the system does not recognize your voice command properly. Say the command slowly again. After the third time this happens, the system will try to guess the command you are requesting. If correct, say “Yes”. If not, say “No”, and the system will prompt you with its next-best guess.
- **“Slower please”** The system responds with this message if you say a command before the system is ready to listen or if your voice command cannot be recognized because of substantial background noise. Try to wait slightly longer before speaking.

■ **There are 5 ways to make a call.**

► Dialing a specific number

STEP 1 Press the  button. When the system responds with “Lexus Link ready”, say “Dial”.

STEP 2 When the system responds with “Phone number to dial please”, say the entire number you wish to dial without pausing.

STEP 3 The system will repeat the number and ask “Yes or No”.

STEP 4 Say “Yes” (or “No” to try again).

STEP 5 The system responds with “Dialing” (your call will then be connected).

► Dialing digit-by-digit (“Digit Dial”)

“Digit Dial” enables you to dial a phone number by individual digit. This is helpful when there is background noise and also improves voice recognition.

STEP 1 Press the  button. When the system responds with “Lexus Link ready”, say “Digit dial”.

STEP 2 When the system responds with “Digit please”, say the first digit of the number to be dialed and wait for it to be repeated back to you.

STEP 3 Continue one digit at a time until all digits are entered.

STEP 4 When finished, say “Dial”. The system responds with “Dialing” and your call is placed.

If you have problems storing a number using the continuous number method, you can store numbers one digit at a time using “Digit Store”. Simply follow the instructions above for “Digit Dial”, except say “Digit Store” in STEP 1 and “Store” in STEP 4.

► Dialing a phone number saved as a nametag

A nametag is a convenient way to store important or frequently called phone numbers for easy access at any time. To do this, choose a frequently-called number to store, the example below uses your home telephone number.

● How to store a nametag

STEP 1 Press the  button. When the system responds with “Lexus Link ready”, say “Store”.

STEP 2 When the system responds with “Phone number to store, please”, say the entire number you wish to store with no pauses. The system will repeat the number and ask “Yes or No”.

STEP 3 Say “Yes” (or “No” to try again).

STEP 4 When the system responds with “Nametag, please”, say “home”.

STEP 5 When the system responds with “About to store home. Does that sound OK?”, say “Yes” (or “No” to try again).

STEP 6 The system responds with “Storing home”.

- The system can store up to 20 nametags.

- Try to use multi-syllable nametags such as “my home”, and “the office”.

- Try to avoid similar-sounding nametags like “Tim” and “Kim”.

When using the “Dial” and “Store” commands, the system will recognize 7, 10, and 11-digit phone numbers. When dialing or storing a phone number, you can say “zero” or “oh” for 0.

● How to place a call using a stored nametag

STEP 1 Press the  button. When the system responds with “Lexus Link ready”, say “Call”.

STEP 2 When the system responds with “Nametag, please”, say the stored nametag.

STEP 3 The system responds with “Calling [nametag]”.

● How to hear a list of your stored nametags

STEP 1 Press the  button. When the system responds with “Lexus Link ready”, say “Directory”.

STEP 2 The system will list your nametags.

▶ Dialing the last number you called (“Redial”)

You can dial the last number you called by using the “Redial” feature.

STEP 1 Press the  button. When the system responds with “Lexus Link ready”, say “Redial”.

STEP 2 The system will respond with “Redialing [#]”.

▶ Dialing a number a Lexus Link Advisor downloaded to your vehicle

STEP 1 Press the  button. When the system responds with “Lexus Link ready”, say “Number recall”.

STEP 2 The system will respond with “Connecting to number recall”.

■ Receiving a call

When someone calls you, you will hear a ring tone. Press the  button to answer the call.

If you do not answer within 30 seconds, the system will terminate the incoming call.

■ Ending a call

When your call is finished, press the  button to end the call.

■ Accessing voicemail and sending number tones to an automated phone system

You can access a voicemail system and respond to a number request from an automated phone system. When you receive the request for a number while in a call, press the  button after saying the numbers one at a time, say “Dial”.

If you do not say any commands within 5 seconds after pressing the button, or if you press the button twice, the system cannot receive the number tones you are trying to send. Press the button to try again.

■ How to retrieve your phone number

STEP 1 Press the  button. When the system responds with “Lexus Link ready”, say “My number”.

STEP 2 The system responds with “Your number is [#]”.

If the response is “Personal calling unavailable”, this means your personal calling feature is not yet active, this may take a few days from vehicle delivery. It could also mean that the personal calling service is not available in your area. Press the  button to check with an Advisor. Now that you have your number, take a moment to practice by making your first call to your home phone. Remember, the system recognizes numbers better when you say them quickly.

■ Verifying remaining units (minutes)

► To verify remaining minutes

STEP 1 Press the  button. When the system responds with “Lexus Link ready”, say “Units”.

STEP 2 When the system responds with “Verify or add”, say “Verify”.

STEP 3 The system responds with “You have [#] units remaining”.

► To add more calling units (minutes)

STEP 1 Press the  button. When the system responds with “Lexus Link ready”, say “Units”.

STEP 2 When the system responds with “Verify or add”, say “Add”.

STEP 3 The system responds with “Connecting to the Personal Calling Center”.

■ Security code/locking your system

The personal calling function can be locked using a 4-digit security code. While the system is locked, it is only possible to communicate with the Lexus Link Call Center.

تلفن شبانه روزی: ۰۲۱-۸۸۶۲۰۸۵

To turn on/off the security

STEP 1 Press the  button. When the system responds with “Lexus Link ready”, say “Security”.

STEP 2 When the system responds with “Enter first digit of code please”, say your 4-digit code one digit at a time.

STEP 3 After the fourth digit, the system responds with “Security (code ####) is now on/off”.

■ Speech recognition information

The Lexus Link speech recognition systems use speech technology that is designed to understand a wide range of speakers of American English. However, the technology may not work as well if a regional or ethnic accent is encountered. If the speech recognition system does not work properly, refer to the following.

- The system does not recognize your command properly if noise is present. Perform the following to improve voice command recognition.
 - Turn down or off the air conditioning system.
 - Slow down to reduce wind noise.
 - Close the windows and the moon roof to block outside noise.
 - Have all occupants be quiet so that the system does not recognize their conversation as a command.
- When to speak
Say a command within 5 seconds after the system prompts you to speak.
- How to speak
 - Speak forcefully and clearly.
 - Speak calmly and naturally.
 - The driver should speak while facing forward, and the passenger should speak facing the inside rear view mirror.
 - Avoid speaking with a rising intonation. Use a flat or falling intonation.
- Tips for one-word commands
 - The system recognizes only one word at a time for personal calling. (There are some exceptions, such as “Advanced services” and “My number”.)
 - When inputting the security codes or voice-activated keypad number, you must say them one digit at a time. When inputting a phone number, the speech recognition system can recognize 7, 10, and 11-digit numbers as well as the number 911.

3-7. Other interior features

- Tips for entering a phone number using the “Dial” and “Store” commands
 - You do not need to say “Dial”, “Store” or “Verify” after the phone number.
 - If the phone number entered is not 7, 10, or 11 digits, use the “Dial” or “Store” command.
 - Do not pause between the digits.
 - Speech recognition does not recognize the words “Hundred” or “Thousand”. Instead, say each digit.
 - Speech recognition often works better when the digits are combined smoothly into a single phrase.
 - If the system does not recognize your command properly, use the “Digit dial” command to enter one digit at a time.
- If problems continue
 - Say each one of the syllables in the word clearly.
 - Be sure to articulate each sound in the word.
 - If the system is confusing 2 commands that are similar, be sure to pronounce the distinction.
 - Avoid clipping short words and syllables.
 - Try speaking louder to prevent background noise from drowning out your voice.
- Audible voice prompts

Some of the voice guidance instructions can be changed to Spanish. Press the



button and ask a Lexus Link Advisor.

■ Information on Advanced Services

See the Lexus Link area of the Lexus website at www.lexus.com/lexuslink/ or call the Lexus Link Call Center at 1-800-25-LEXUS (1-800-255-3987) (toll-free) for more information.

■ Certification for the Lexus Link System

FCC ID: SCWTR-423-A2

NOTE:

This device complies with Part 15 of the FCC Rules. Operation is subject to the following two conditions: (1) this device may not cause harmful interference and (2) this device must accept any interference received, including interference that may cause undesired operation.

CAUTION

■ FCC WARNING

Changes or modifications in construction not expressly approved by the party responsible for compliance could void the user's authority to operate the equipment.

Radio Frequency Exposure. This device is approved for Mobile Application only and, to comply with applicable FCC radio frequency exposure regulations, must be used with a distance of at least 7.9 in. (20 cm) between the antenna and the body of any person at all time during use.

FarmaSOS.com

امداد خودرو فارما

تلفن شبانه روزی: ۰۲۱-۸۸۸۶۲۰۸۵

FarmaSOS.com

4-1. Maintenance and care	388	4-2. Maintenance	394
Cleaning and protecting the vehicle exterior	388	Maintenance requirements	394
Cleaning and protecting the vehicle interior	391	General maintenance	396
		Emission inspection and maintenance (I/M) programs	399
		4-3. Do-it-yourself maintenance	400
		Do-it-yourself service precautions	400
		Hood	403
		Positioning a floor jack	404
		Engine compartment	406
		Tires	421
		Tire inflation pressure	431
		Wheels	435
		Air conditioning filter	437
		Electronic key battery	440
		Checking and replacing fuses	442
		Headlight aim	467
		Light bulbs	470

4-1. Maintenance and care

Cleaning and protecting the vehicle exterior

Perform the following to protect the vehicle and maintain it in prime condition.

- Working from top to bottom, liberally apply water to the vehicle body, wheel wells and underside of the vehicle to remove any dirt and dust.

Wash the vehicle body using a sponge or soft cloth, such as a chamois.

- For hard-to-remove marks, use car wash soap and rinse thoroughly with water.
- Wipe away any water.
- Wax the vehicle when the waterproof coating deteriorates.

If water does not bead on a clean surface, apply wax when the vehicle body is cool.

■ Automatic car washes

تلفن شبانه روزی: ۰۲۱-۸۸۶۲۰۸۵

- Fold the mirrors back before washing the vehicle.
- Brushes used in automatic car washes may scratch the vehicle surface and harm your vehicle's paint.
- Before entering an automatic car wash, check that the fuel filler door is closed.

■ High pressure washers

Do not allow the nozzles of the washers to come within close proximity of the windows and fuel filler door.

■ Aluminum wheels

Remove any dirt immediately by using a neutral detergent. Do not use hard brushes or abrasive cleaners. Do not use strong or harsh chemical cleaners. Use the same mild detergent and wax as used on the paint.

■ Bumpers and side moldings

Do not scrub with abrasive cleaners.

■ To prevent paint deterioration and corrosion on the body

- Wash the vehicle immediately in the following cases:
 - After driving near the sea coast
 - After driving on salted roads
 - If you see coal tar or tree sap on the paint surface
 - If you see dead insects, insect droppings or bird droppings on the paint
 - After driving in an area contaminated with soot, oily smoke, mine dust, iron powder or chemical substances
 - If the vehicle becomes heavily soiled in dust or mud
 - If liquids such as benzene and gasoline are spilled on the paint surface
- If the paint is chipped or scratched, have it repaired immediately.

تلفن شبانه روزی: ۰۲۱-۸۸۶۲۰۸۵

⚠ CAUTION

■ Caution about the exhaust pipe

Exhaust gasses cause the exhaust pipe to become quite hot.

When washing the vehicle, be careful not to touch the pipe until it has cooled sufficiently, as touching a hot exhaust pipe can cause burns.

NOTICE

■ To protect your vehicle's painted surfaces

Do not use organic cleaners such as benzene or gasoline.

■ Cleaning the exterior lights

● Wash carefully. Do not use organic substances or scrub with a hard brush. This may damage the surfaces of the lights.

● Do not apply wax on the surfaces of the lights. Wax may cause damage to the lenses.

■ When using an automatic car wash (with rain-sensing windshield wipers)



Set the wiper switch to "OFF".

If the wiper switch is in "AUTO", the wipers may operate and the wiper blades may be damaged.

تلفن شبانه روزی: +۸۵-۸۸۶۲۰۲۱

FarmaSOS.com

Cleaning and protecting the vehicle interior

The following procedures will help protect your vehicle's interior and keep it in top condition:

■ Protecting the vehicle interior

Remove dirt and dust using a vacuum cleaner. Wipe dirty surfaces with a cloth dampened with lukewarm water.

■ Cleaning the leather areas

- Remove dirt and dust using a vacuum cleaner.
- Wipe any excess dirt and dust with a soft cloth dampened with diluted detergent.

Use a diluted water solution of approximately 5% neutral wool detergent.

- Wring out any excess water from the cloth and thoroughly wipe off all remaining traces of detergent.
- Wipe the surface with a dry, soft cloth to remove any remaining moisture. Allow the leather to dry in a shaded and ventilated area.

■ Synthetic leather areas

- Remove loose dirt using a vacuum cleaner.
- Apply a mild soap solution to the synthetic leather using a sponge or soft cloth.
- Allow the solution to soak in for a few minutes. Remove the dirt and wipe off the solution with a clean, damp cloth.

■ Cleaning the inside of the rear window

Do not use glass cleaner to clean the rear window, as this may cause damage to the rear window defogger heater wires. Use a cloth dampened with lukewarm water to gently wipe the window clean. Wipe the window in strokes running parallel to the heater wires.

■ Caring for leather areas

Lexus recommends cleaning the interior of the vehicle at least twice a year to maintain the quality of the vehicle's interior.

■ Shampooing the carpets

There are several commercial foaming-type cleaners available. Use a sponge or brush to apply the foam. Rub in overlapping circles. Do not apply water. The excellent results are obtained by keeping the carpet as dry as possible.

■ Seat belts

Clean with mild soap and lukewarm water using a cloth or sponge. Also check the belts periodically for excessive wear, fraying or cuts.



CAUTION

تلفن شبانه روزی: ۰۲۱-۸۸۶۲۰۸۵

■ Water in the vehicle

- Be careful not to splash or spill liquid on the floor.
- Do not get any of the SRS components or wiring in the vehicle interior wet. (→P. 81)

Electrical malfunction may cause the airbags to deploy or not function properly, resulting in death or serious injury.

 NOTICE

■ Cleaning detergents

Do not use the following types of detergent, as they may discolor the vehicle interior or cause streaks or damage to painted surfaces.

- Non-seat portions: Organic substances such as benzene or gasoline, alkaline or acidic solutions, dye, or bleach.
- Seats: Acidic solutions, such as thinner, benzene, or alcohol.

■ Preventing damage to leather surfaces

Observe the following precautions to avoid damage to and deterioration of leather surfaces.

- Remove any dust or dirt on leather surfaces immediately.
- Do not expose the vehicle to direct sunlight for extended periods of time. Park the vehicle in the shade, especially during summer.
- Do not place items made of vinyl, plastic, or that contain wax on the upholstery, as they may stick to the leather surface if the vehicle interior heats up significantly.

■ Water on the floor

Do not wash the vehicle floor with water.

Vehicle systems such as the audio system may be damaged if water comes into contact with electrical components under the floor of the vehicle, and may also cause the body to rust.

■ Cleaning the inside of the rear window

Be careful not to scratch or damage the heater wires or antenna.

4-2. Maintenance

Maintenance requirements

To ensure safe and economical driving, day-to-day care and regular maintenance is essential. It is the owner's responsibility to perform regular checks. Lexus recommends the following maintenance.

■ General maintenance

Should be performed on a daily basis. This can be done by yourself or by a Lexus dealer.

■ Scheduled maintenance

Should be performed at specified intervals according to the maintenance schedule.

For details about maintenance items and schedules, refer to the "Warranty and Services Guide/Owner's Manual Supplement/Scheduled Maintenance".

■ Do-it-yourself maintenance

You can perform some maintenance procedures yourself.

Please be aware that do-it-yourself maintenance may affect warranty coverage.

The use of Lexus Repair Manuals is recommended.

For details about warranty coverage, see the separate "Owner's Guide", "Warranty and Services Guide", "Owner's Manual Supplement" or "Warranty Booklet".

■ Repair and replacement

It is recommended that genuine Lexus parts be used for repair to ensure performance of each system. If non-Lexus parts are used in replacement or if a repair shop other than a Lexus dealer performs repairs, confirm the warranty coverage.

■ Allow inspection and repairs to be performed by a Lexus dealer

- Lexus technicians are well-trained specialists and are kept up to date with the latest service information. They are well informed about the operations of all systems on your vehicle.
- Keep a copy of the repair order. It proves that the maintenance that has been performed is under warranty coverage. If any problem should arise while your vehicle is under warranty, your Lexus dealer will promptly take care of it.

CAUTION

■ Hazardous materials

- Engine exhaust, some of its constituents, and a wide variety of automobile components contain or emit chemicals known to the State of California to cause cancer and birth defects and other reproductive harm. Work in a well ventilated area.
- Oils, fuels and fluids contained in vehicles as well as waste produced by component wear contain or emit chemicals known to the State of California to cause cancer and birth defects or other reproductive harm. Avoid exposure and wash any affected area immediately.
- 12 volt battery posts, terminals and related accessories contain lead and lead compounds which are known to cause brain damage. Wash your hands after handling. (→P. 417)
- Used engine oil contains chemicals that have been shown to cause cancer in laboratory animals. Avoid prolonged and repeated contact. Always protect your skin by washing thoroughly with soap and water.

4-2. Maintenance

General maintenance

Listed below are the general maintenance items that should be performed at the intervals specified in the “Warranty and Services Guide/Owner’s Manual Supplement”. It is recommended that any problem you notice should be brought to the attention of your Lexus dealer or qualified service shop for advice.

Engine compartment

Items	Check points
Brake fluid	• At the correct level? (→P. 416)
Engine coolant	• At the correct level? (→P. 414)
Engine oil	• At the correct level? (→P. 409)
Exhaust system	• No fumes or strange sounds?
Radiator/condenser/hoses	• Not blocked with foreign matter? (→P. 415)
Washer fluid	• At the correct level? (→P. 420)
12 volt battery	• Maintenance-free (→P. 417)

Vehicle interior

Items	Check points
Accelerator pedal	<ul style="list-style-type: none"> • Moves smoothly (without uneven pedal effort or catching)?
Automatic transmission "Park" mechanism	<ul style="list-style-type: none"> • Can the vehicle be hold securely on an incline with the shift lever in "P"?
Brake pedal	<ul style="list-style-type: none"> • Moves smoothly? • Does it have appropriate clearance and correct amount of free play?
Brakes	<ul style="list-style-type: none"> • Pulls to one side when applied? • Loss of brake effectiveness? • Spongy feeling brake pedal? • Pedal almost touches floor?
Head restraints	<ul style="list-style-type: none"> • Move smoothly and lock securely?
Indicators/buzzers	<ul style="list-style-type: none"> • Function properly?
Lights	<ul style="list-style-type: none"> • Do all the lights come on? • Headlights aimed correctly? (→P. 467)
Parking brake	<ul style="list-style-type: none"> • Moves smoothly? • Can hold the vehicle securely on an incline?
Seat belts	<ul style="list-style-type: none"> • Does the seat belt system operate smoothly? • Are the belts undamaged?
Seats	<ul style="list-style-type: none"> • Do the seat controls operate properly?
Steering wheel	<ul style="list-style-type: none"> • Moves smoothly? • Has correct free play? • No strange noises?

Vehicle exterior

Items	Check points
Doors/trunk	<ul style="list-style-type: none"> • Operate smoothly?
Engine hood	<ul style="list-style-type: none"> • The lock system works properly?
Fluid leaks	<ul style="list-style-type: none"> • Is there any leakage after parking?
Tire	<ul style="list-style-type: none"> • Inflation pressure is correct? • Tire surfaces not worn or damaged? • Tires rotated according to the maintenance schedule? • Wheel nuts are not loose?

CAUTION

■ **If the engine is running** ۲۱-۸۸۶۲۰۸۵ تلفن شبانه روزی:

Turn off the engine and ensure that there is adequate ventilation before performing maintenance checks.

FarmaSOS.com

Some states have vehicle emission inspection programs which include OBD (On Board Diagnostics) checks. The OBD system monitors the operation of the emission control system.

■ If the malfunction indicator lamp comes on

The OBD system determines that a problem exists somewhere in the emission control system. Your vehicle may not pass the I/M test and may need to be repaired. Contact your Lexus dealer to service the vehicle.

■ Your vehicle may not pass the I/M test:

- When the 12 volt battery is disconnected or discharged

Readiness codes that are set during ordinary driving are erased. Also, depending on your driving habits, the readiness codes may not be completely set.

- When the fuel tank cap is loose

The malfunction indicator lamp comes on as a temporary malfunction and your vehicle may not pass the I/M test.

■ When the malfunction indicator lamp goes off after several driving trips

The error code in the OBD system will not be cleared unless the vehicle is driven 40 or more times.

■ If your vehicle does not pass the I/M test

Contact your Lexus dealer to prepare the vehicle for re-testing.

4-3. Do-it-yourself maintenance

Do-it-yourself service precautions

If you perform maintenance yourself, be sure to follow the correct procedure given in these sections.

Items	Parts and tools
12 volt battery condition (→P. 417)	<ul style="list-style-type: none">• Grease• Conventional wrench (for terminal clamp bolts)
Brake fluid level (→P. 416)	<ul style="list-style-type: none">• FMVSS No.116 DOT 3 or SAE J1703 brake fluid• Rag or paper towel• Funnel (used only for adding brake fluid)
Engine coolant level (→P. 414)	<ul style="list-style-type: none">• “Toyota Super Long Life Coolant” or similar high quality ethylene glycol based non-silicate, non-amine, non-nitrite and non-borate coolant with long-life hybrid organic acid technology.For the U.S.A.: “Toyota Super Long Life Coolant” is pre-mixed with 50% coolant and 50% deionized water.For Canada: “Toyota Super Long Life Coolant” is pre-mixed with 55% coolant and 45% deionized water.• Funnel (used only for adding coolant)

Items	Parts and tools
Engine oil level (→P. 409)	<ul style="list-style-type: none"> • “Toyota Genuine Motor Oil” or equivalent • Rag or paper towel, funnel (used only for adding engine oil)
Fuses (→P. 442)	<ul style="list-style-type: none"> • Fuse with same amperage rating as original
Headlight aim (→P. 467)	<ul style="list-style-type: none"> • Phillips-head screwdriver
Radiator and condenser (→P. 415)	—
Tire inflation pressure (→P. 431)	<ul style="list-style-type: none"> • Tire pressure gauge • Compressed air source
Washer fluid (→P. 420)	<ul style="list-style-type: none"> • Water washer fluid containing anti-freeze (for winter use) • Funnel

FarmaSOS.com

 CAUTION

The engine compartment contains many mechanisms and fluids that may move suddenly, become hot, or become electrically energized. To avoid death or serious injury, observe the following precautions.

■ **When working on the engine compartment**

- Keep hands, clothing, and tools away from the moving fan and engine drive belt.
- Be careful not to touch the engine, radiator, exhaust manifold, etc. right after driving as they may be hot. Oil and other fluids may also be hot.
- Do not leave anything that may burn easily, such as paper or rags, in the engine compartment.
- Do not smoke, cause sparks or expose an open flame to fuel or the 12 volt battery. Fuel and 12 volt battery fumes are flammable.
- Be extremely cautious when working on the 12 volt battery. It contains poisonous and corrosive sulfuric acid.

■ **When working near the electric cooling fan or radiator grille**

Be sure the "ENGINE START STOP" switch is OFF.

With the "ENGINE START STOP" switch in IGNITION ON mode, the electric cooling fan may automatically start to run if the air conditioning is on and/or the coolant temperature is high. (→P. 415)

■ **Safety glasses**

Wear safety glasses to prevent flying or falling material, fluid spray, etc. from getting in the eyes.

 NOTICE

■ **If you remove the air cleaner filter**

Driving with the air cleaner filter removed may cause excessive engine wear due to dirt in the air. Also a backfire could cause a fire in the engine compartment.

4-3. Do-it-yourself maintenance

Hood

Release the lock from the inside of the vehicle to open the hood.

STEP 1



Pull the hood lock release lever.

The hood will pop up slightly.

STEP 2



Lift the hood catch and lift the hood.

CAUTION

FarmaSOS.com

■ Pre-driving check

Check that the hood is fully closed and locked.

If the hood is not locked properly it may open while the vehicle is in motion and cause an accident, which may result in death or serious injury.

4-3. Do-it-yourself maintenance

Positioning a floor jack

When raising your vehicle with a floor jack, position the jack correctly. Improper placement may damage your vehicle or cause injury.

► Front



► Rear



⚠ CAUTION

■ When raising your vehicle

Make sure to observe the following to reduce the possibility of death or serious injury.



● Lift up the vehicle using a floor jack such as the one shown in the illustration.

- Do not use the jack that was supplied with your vehicle.
- Do not put any part of your body or get underneath the vehicle supported only by the floor jack.
Always use automotive jack stands or a solid, level surface.
- Do not start the engine while the vehicle is supported by the floor jack.
- Stop the vehicle on level firm ground, firmly set the parking brake and put the shift lever in "P".
- Make sure to set the floor jack properly at the jack point.
Raising the vehicle with an improperly positioned floor jack will damage the vehicle and may cause the vehicle to fall off the floor jack.
- Do not raise the vehicle while someone is in the vehicle.
- When raising the vehicle, do not place any objects on top of or underneath the floor jack.

4-3. Do-it-yourself maintenance

Engine compartment

► GS460



ILY43S003

- 1 Engine oil level dipstick (→P. 409)
- 2 Engine oil filler cap (→P. 410)
- 3 Brake fluid reservoir (→P. 416)
- 4 Fuse box (→P. 442)
- 5 Washer fluid tank (→P. 420)
- 6 Engine coolant reservoir (→P. 414)
- 7 Electric cooling fans
- 8 Condenser (→P. 415)
- 9 Radiator (→P. 415)
- 10 Fuse box (→P. 442)
- 11 12 volt battery (→P. 417)

▶ GS350

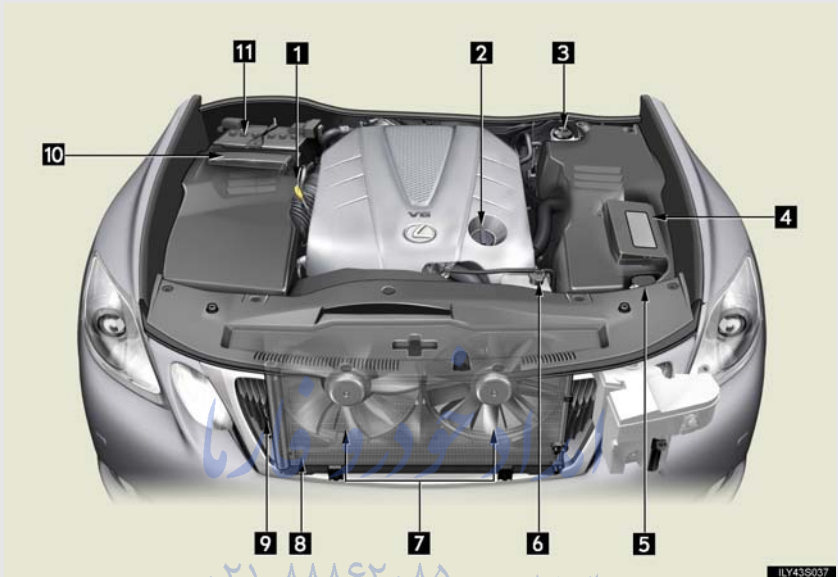

- | | |
|---|--|
| 1 Engine oil level dipstick
(→P. 409) | 6 Engine coolant reservoir
(→P. 414) |
| 2 Engine oil filler cap
(→P. 410) | 7 Electric cooling fans |
| 3 Brake fluid reservoir
(→P. 416) | 8 Condenser
(→P. 415) |
| 4 Fuse box
(→P. 442) | 9 Radiator
(→P. 415) |
| 5 Washer fluid tank
(→P. 420) | 10 Fuse box
(→P. 442) |
| | 11 12 volt battery
(→P. 417) |

Engine compartment cover

■ Removing the cover

▶ Front



▶ Right-hand side



▶ Left-hand side



■ Installing the clips

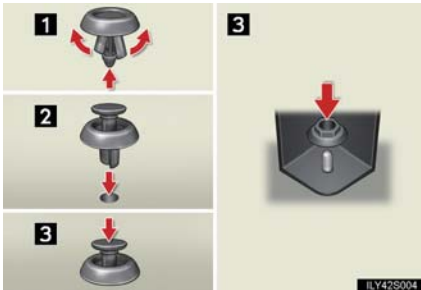

- 1 Push up center portion
- 2 Insert
- 3 Press

Engine oil

With the engine at operating temperature and turned off, check the oil level on the dipstick.

■ Checking the engine oil

STEP 1 Park the vehicle on level ground. After turning off the engine, wait a few minutes for the oil to drain back into the bottom of the engine.

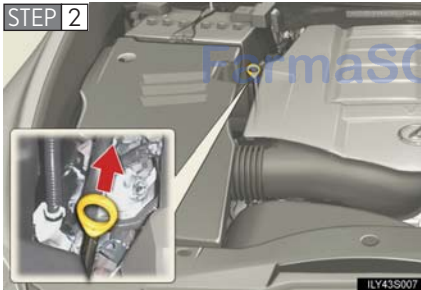

Hold a rag under the end and pull the dipstick out.

STEP 3 Wipe the dipstick clean.

STEP 4 Reinsert the dipstick fully.

STEP 5 Holding a rag under the end, pull the dipstick out and check the oil level.

STEP 6 Wipe the dipstick and reinsert it fully.

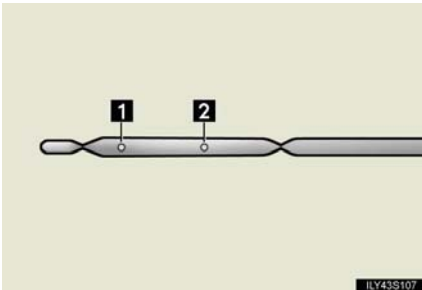

- 1 Low
- 2 Full

■ Adding engine oil



If the oil level is below or near the low level mark, add engine oil of the same type as already in the engine.

تلفن شبانه روزی: ۰۲۱-۸۸۸۸۸۸۸۸

Make sure to check the oil type and prepare the items needed before adding oil.

FarmaSOS.com

Oil grade	ILSAC multigrade engine oil
Oil quantity (Low → Full)	1.6 qt. (1.5 L, 1.3 Imp. qt.)
Items	Clean funnel

STEP 1 Remove the oil filler cap.

STEP 2 Add engine oil slowly, checking the dipstick.

STEP 3 Install the filler cap, turning it clockwise.

■ Recommended viscosity

▶ GS460

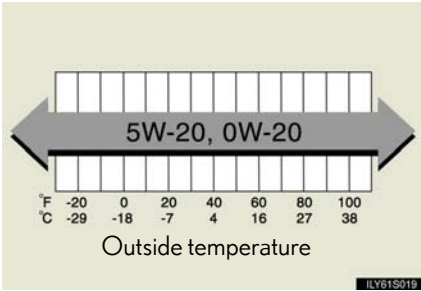

SAE 5W-20 or 0W-20 engine oil may be used. However, SAE 0W-20 is the best choice for good fuel economy and good starting in cold weather.

▶ GS350

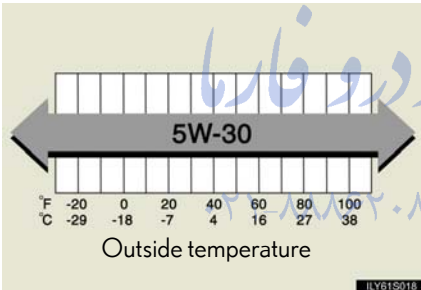

SAE 5W-30 is the best choice for good fuel economy, and good starting in cold weather.

If SAE 5W-30 oil is not available, SAE 10W-30 oil may be used. However, it should be replaced with SAE 5W-30 at the next oil change.

■ How to read oil container labels

The ILSAC (International Lubricant Standardization and Approval Committee) Certification Mark is added to some oil containers to help you select the oil you should use.



■ Engine oil consumption

- The amount of engine oil consumed depends on the oil viscosity, the quality of the oil and the way the vehicle is driven.
- More oil is consumed under driving conditions such as high speeds, frequent acceleration and deceleration.
- A new engine consumes more oil.
- When judging the amount of oil consumption, keep in mind that the oil may have become diluted, making it difficult to judge the true level accurately.
- Oil consumption: Max. 1.1 qt./600 miles, 0.9 Imp.qt./600 miles (1.0 L per 1000 km). If the vehicle consumes more than this amount, contact your Lexus dealer.

■ Resetting the engine oil maintenance data (U.S.A. only)

Perform the following steps:

- STEP 1** Press the “DISP” switch (→P. 140) to change the multi-information display to blank.
- STEP 2** Turn the “ENGINE START STOP” switch to OFF.
- STEP 3** Turn the “ENGINE START STOP” switch to IGNITION ON mode with the trip meter reset button held down.
- STEP 4** Keep pressing the button for longer than 7 seconds after the “ENGINE START STOP” switch is in IGNITION ON mode.



After the above operation, the message shown in the left will appear on the display.

The master warning light and tone will turn on. After 5 seconds, the system reset is completed.

 CAUTION**■ Used engine oil**

- Used engine oil contains potentially harmful contaminants which may cause skin disorders such as inflammation or skin cancer, so care should be taken to avoid prolonged and repeated contact. To remove used engine oil from your skin, wash thoroughly with soap and water.
- Dispose of used oil and filters only in a safe and acceptable manner. Do not dispose of used oil and filters in household trash, in sewers or onto the ground. Call your Lexus dealer, service station or auto parts store for information concerning recycling or disposal.
- Do not leave used engine oil within the reach of children.

 NOTICE**■ To prevent serious engine damage**

Check the oil level on regular basis.

■ When replacing the engine oil

- Be careful not to spill engine oil on the vehicle components.
- Avoid overfilling, or the engine could be damaged.
- Check the oil level on the dipstick every time you refill the vehicle.
- Be sure the engine oil filler cap is properly tightened.

Coolant

The coolant level is satisfactory if it is between the “FULL” and “LOW” lines on the reservoir when the engine is cold.

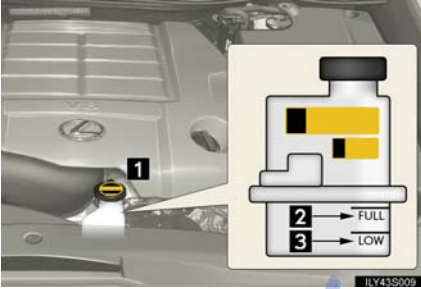

1 Reservoir cap

2 “FULL”

3 “LOW”

If the level is on or below the “LOW” line, add coolant up to the “FULL” line.

■ If the coolant level drops within a short time after replenishing

Visually check the radiator, hoses, reservoir cap, radiator cap, drain cock and water pump.

If you cannot find a leak, have your Lexus dealer pressure test the cap and check for leaks in the cooling system.

■ Coolant selection

Only use “Toyota Super Long Life Coolant” or similar high quality ethylene glycol based non-silicate, non-amine, non-nitrite, and non-borate coolant with long-life hybrid organic acid technology.

U.S.A.: “Toyota Super Long Life Coolant” is a mixture of 50% coolant and 50% deionized water. (Enabled: -31°F [-35°C])

Canada: “Toyota Super Long Life Coolant” is a mixture of 55% coolant and 45% deionized water. (Enabled: -44°F [-42°C])

For more details about coolant, contact your Lexus dealer.

⚠ CAUTION**■ When the engine is hot**

Do not remove the radiator and reservoir cap.

The cooling system may be under pressure and may spray hot coolant if the cap is removed, causing burns or other injuries.

⚠ NOTICE**■ When adding the coolant**

Coolant is neither plain water nor straight antifreeze. The correct mixture of water and antifreeze must be used to provide proper lubrication, corrosion protection and cooling. Be sure to read the antifreeze or coolant label.

■ If you spill coolant

Be sure to wash it off with water to prevent it from damaging to parts or paint.

Radiator and condenser

Check the radiator and condenser and clear any foreign objects.

If either of the above parts are extremely dirty or you are not sure of their condition, have your vehicle checked by your Lexus dealer.

⚠ CAUTION**■ When the engine is hot**

Do not touch the radiator or condenser, as they may be hot and you may be burned.

Brake fluid

■ Checking fluid level



The brake fluid level should be between the “MAX” and “MIN” lines on the tank.

Make sure to check the fluid type and prepare the necessary items.

■ Adding fluid

Fluid type	FMVSS No.116 DOT 3 or SAE J1703 brake fluid
Items	Clean funnel

تلفن شبانه روزی: ۰۲۱-۸۸۶۲۰۸۵

■ Brake fluid can absorb moisture from the air

Excess moisture in the fluid can cause a dangerous loss of braking efficiency. Use only newly opened brake fluid.

⚠ CAUTION

■ When filling the reservoir

Take care because brake fluid can harm your hands or eyes and damage painted surfaces.

If fluid gets in your eyes, flush your eyes with clean water immediately.

If you still experience discomfort, see a doctor.

 NOTICE

■ **If the fluid level is low or high**

It is normal for the brake fluid level to go down slightly as the brake pads wear or when the fluid level in the accumulator is high.

If the reservoir needs frequent refilling, it may indicate a serious problem.

12 volt battery

Check the battery as follows.

■ **Exterior**

Make sure that the battery terminals are not corroded and that there are no loose connections, cracks, or loose clamps.

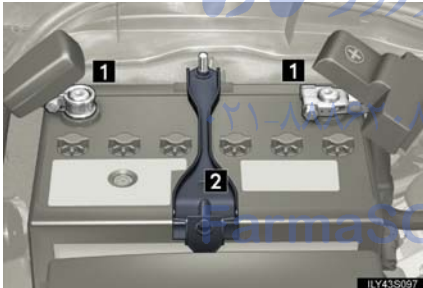

1 Terminals

2 Hold-down clamp

■ **Check battery condition**

Check the battery condition by the indicator color.

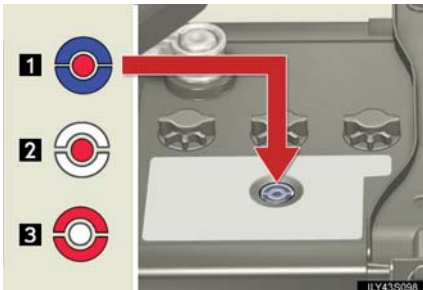

1 Blue: Good condition

2 White: Charging necessary

Have the battery checked by your Lexus dealer.

3 Red: Not working properly, have the battery checked by your Lexus dealer.

■ Before recharging

When recharging, the battery produces hydrogen gas which is flammable and explosive. Therefore, before recharging:

- If recharging with the battery installed on the vehicle, be sure to disconnect the ground cable.
- Make sure the power switch on the charger is off when connecting and disconnecting the charger cables to the battery.

■ After recharging/reconnecting the battery

In some cases, the engine may not start. Follow one or both of the following procedures:

- After opening and closing the driver's door, wait 10 seconds then attempt to start the engine. (If the system does not start first time, repeat the procedure.)
- With the shift lever in "P" and the "ENGINE START STOP" switch is OFF, open and close any door, then attempt to start the engine.

If the system will not start even after multiple attempts at both methods, contact your Lexus dealer.

تلفن شبانه روزی: ۰۲۱-۸۸۶۲۰۸۵

FarmaSOS.com

 **CAUTION**
■ Chemicals in the battery

A battery contains poisonous and corrosive sulfuric acid and may produce hydrogen gas which is flammable and explosive. To reduce the risk of death or serious injury, take the following precautions while working on or near battery:

- Do not cause sparks by touching the battery terminals with tools.
- Do not smoke or light a match near the battery.
- Avoid contact with eyes, skin and clothes.
- Never inhale or swallow electrolyte.
- Wear protective safety glasses when working near the battery.
- Keep children away from the battery.

■ Where to safely charge the battery

Always charge the battery in an open area. Do not charge the battery in a garage or closed room where there is not sufficient ventilation.

■ How to recharge the battery

Only perform a slow charge (5A or less). The battery may explode if charged at a quicker rate.

■ Emergency measures regarding electrolyte

- If electrolyte gets in your eyes
Flush your eyes with clean water for at least 15 minutes and get immediate medical attention. If possible, continue to apply water with a sponge or cloth while traveling to the nearest medical facility.
- If electrolyte gets on your skin
Wash the affected area thoroughly. If you feel pain or a burning sensation, seek medical attention immediately.
- If electrolyte gets on your clothes
It can soak through clothing on to your skin. Immediately take off the clothing and follow the procedure above if necessary.
- If you accidentally swallow electrolyte
Drink a large quantity of water or milk. Follow with milk of magnesia, beaten raw egg or vegetable oil. Get emergency medical attention immediately.

NOTICE

■ When recharging the battery

Never recharge the battery while the engine is on. Also, be sure all accessories are turned off.

Washer fluid



If any washer does not work or the warning message appears on the multi-information display, the washer tank may be empty. Add washer fluid.

CAUTION

■ When refilling the washer fluid

Do not refill the washer fluid when the engine is hot or running, as the washer fluid contains alcohol and may catch the fire if spilled on the engine etc.

NOTICE

■ Do not use any fluid other than washer fluid

Do not use soapy water or engine antifreeze instead of washer fluid. Doing so may cause streaking on the vehicle's painted surfaces.

■ Diluting washer fluid

Dilute washer fluid with water as necessary. Refer to the freezing temperatures listed on the washer fluid tank.

4-3. Do-it-yourself maintenance

Tires

Replace or rotate tires in accordance with maintenance schedule and treadwear.

■ Checking tires



- 1 New tread
- 2 Treadwear indicator
- 3 Worn tread

The location of treadwear indicators is shown by the “TWI” or “△” marks, etc., molded on the sidewall of each tire.

Check spare tire condition and inflation pressure if not rotated.

■ Tire rotation

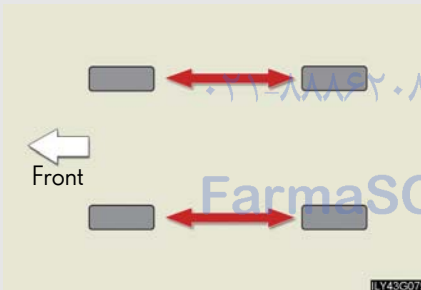

Rotate the tires in the order shown.

To equalize tire wear and extend tire life, Lexus recommends that tire rotation is carried out at the same interval as tire inspection.

■ The tire pressure warning system

Your Lexus is equipped with a tire pressure warning system that uses tire pressure warning valves and transmitters to detect low tire inflation pressure before serious problems arise. (→P. 490, 498)

Installing tire pressure warning valves and transmitters

When replacing tires or wheels, tire pressure warning valves and transmitters must also be installed.

When new tire pressure warning valves and transmitters are installed, new tire pressure warning valve and transmitter ID codes must be registered in the tire pressure warning computer and tire pressure warning system must be initialized. Have tire pressure warning valve and transmitter ID codes registered by your Lexus dealer. (→P. 424)

Initializing the tire pressure warning system

■ **The tire pressure warning system must be initialized in the following circumstances:**

- When rotating the tires on vehicles differing with front and rear tire inflation pressures.
- When changing the tire inflation pressure by changing traveling speed or load weight, etc.

When the tire pressure warning system is initialized, the current tire inflation pressure is set as the pressure benchmark.

■ How to initialize the tire pressure warning system

STEP 1 Park the vehicle in safe place and turn the “ENGINE START STOP” switch to OFF.

While the vehicle is moving, initialization is not performed.

STEP 2 Adjust the tire inflation pressure to the specified cold tire inflation pressure level. (→P. 550)

Make sure to adjust the tire pressure to the specified cold tire inflation pressure level. The tire pressure warning system will operate based on this pressure level.

STEP 3 Turn the “ENGINE START STOP” switch to IGNITION ON mode.

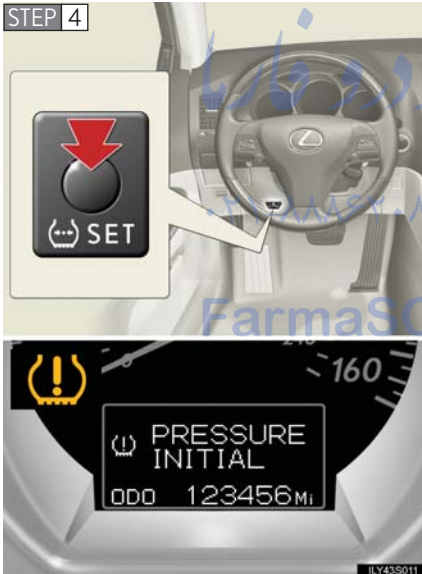

Push and hold the tire pressure warning reset switch until the tire pressure warning light blinks slowly three times and the message “PRESSURE INITIAL” appears on the multi-information display.

STEP 5 Wait for a few minutes with the IGNITION ON mode, and then turn “ENGINE START STOP” switch to the OFF.

Registering and selecting ID codes

■ Registering ID codes

2 sets of tire pressure warning valve and transmitter ID codes can be registered. Once a second set of tires is registered at “2nd”, you can switch between tire set settings simply by pressing the tire pressure warning select switch.

There are 2 settings:

“MAIN” position: The ID code of the tire pressure warning valve and transmitter on the tires originally installed on the vehicle is registered.

“2nd” position: The ID code is not registered. When you replace a new set of tires, purchase tire pressure warning valves and transmitters from your Lexus dealer and have the new ID code registered by your Lexus dealer.

■ Selecting ID codes

When replacing tires, make sure to select the ID code set that matches the new tire set. If the tire pressure warning select switch is set to the wrong tire setting, the tire pressure warning system will not operate properly. After driving for about 20 minutes, the tire pressure warning light comes on after blinking for 1 minute to indicate a system malfunction.

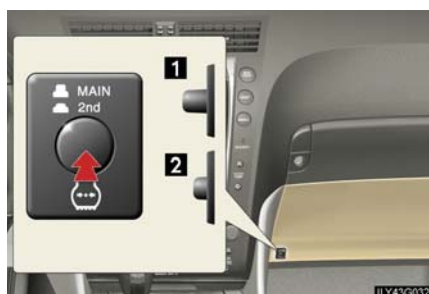

1 “MAIN”

2 “2nd”

■ When to replace your vehicle's tires

Tires should be replaced if:

- You have tire damage such as cuts, splits, cracks deep enough to expose the fabric or bulges indicating internal damage
- A tire goes flat repeatedly or cannot be properly repaired due to the size or location of a cut or other damage

If you are not sure, consult with your Lexus dealer.

■ Replacing tires and wheels

If the ID code of the tire pressure warning valve and transmitter is not registered, the tire pressure warning system will not work properly. After driving for about 20 minutes, the tire pressure warning light comes on after blinking for 1 minute to indicate a system malfunction.

■ Tire life

Any tire over 6 years old must be checked by a qualified technician even if they have seldom or never been used or damage is not obvious.

■ If the tread wears down below 0.16 in. (4 mm) on snow tires

The effectiveness of snow tires is lost.

■ Low profile tires (245/40R18, P245/40R18 and 245/40ZR18 tires)

Generally, low profile tires will wear more rapidly and tire grip performance will be reduced on snowy and/or icy roads when compared to standard tires. Be sure to use snow tires or snow chains on snowy and/or icy roads and drive carefully at a speed appropriate for road and weather conditions.

■ Initializing the tire pressure warning system

Initialize the tires with the tire inflation pressure adjusted to the specified level.

■ Maximum load of tire

Check that the maximum load of the replaced tire is greater than 1/2 of the Gross Axle Weight Ratings (GAWR) of either the front axle or the rear axle, whichever is greater.

As for the maximum load of the tire, see the load limit at maximum cold tire inflation pressure mentioned on the sidewall of the tire, and as for the Gross Axle Weight Ratings (GAWR), see the Certification Label. (→P. 431, 556).

■ Tire types

1 Summer tires

Summer tires are high-speed performance tires best suited to highway driving under dry conditions. Since summer tires do not have the same traction performance as snow tires, summer tires are inadequate for driving on snow-covered or icy roads. For driving on snow-covered roads or icy roads, the use of snow tires is recommended. When installing snow tires, be sure to replace all four tires.

2 All season tires

All season tires are designed to provide better traction in snow and to be adequate for driving in most winter conditions, as well as for use year round. All season tires, however, do not have adequate traction performance compared with snow tires in heavy or loose snow. Also, all season tires fall short in acceleration and handling performance compared with summer tires in highway driving.

3 Snow tires

For driving on snow-covered roads or icy roads, we recommend using snow tires. If you need snow tires, select tires of the same size, construction and load capacity as the originally installed tires. Since your vehicle has radial tires as original equipment, make sure your snow tires also have radial construction. Do not install studded tires without first checking local regulations for possible restriction. Snow tires should be installed on all wheels. (→P. 199)

■ Initializing the tire pressure warning system

Initialize the tires with the tire inflation pressure adjusted to the specified level.

■ If you push the tire pressure warning reset switch accidentally

If initialization is performed, adjust the tire inflation pressure to the specified level and initialize the system again.

■ When the initialization of the tire pressure warning system has failed

Initialization can be completed in a few minutes. However, in the following cases, the settings have not been recorded and the system will not operate properly. If repeated attempts to record tire inflation pressure settings are unsuccessful, have the vehicle inspected by your Lexus dealer.

- When operating the tire pressure warning reset switch, the tire pressure warning light does not flash 3 times and the setting message does not appear on the multi-information display.
- After carrying out the initialization procedure, the tire pressure warning light blinks for 1 minute then stays on after driving for 20 minutes.

■ Routine tire inflation pressure checks

The tire pressure warning system does not replace routine tire inflation pressure checks. Make sure to check tire inflation pressure as part of your routine of daily vehicle checks.

FarmaSOS.com

■ Tire pressure warning system certification

► For vehicles sold in the U.S.A.

NOTE:

This device complies with Part 15 of the FCC Rules. Operation is subject to the following two conditions: (1) this device may not cause harmful interference, and (2) this device must accept any interference received, including interference that may cause undesired operation.

NOTICE:

This equipment has been tested and found to comply with the limits for a Class B digital device, pursuant to Part 15 of the FCC Rules. These limits are designed to provide reasonable protection against harmful interference in a residential installation. This equipment generates, uses and can radiate radio frequency energy and, if not installed and used in accordance with the instructions, may cause harmful interference to radio communications. However, there is no guarantee that interference will not occur in a particular installation. If this equipment does cause harmful interference to radio or television reception, which can be determined by turning the equipment off and on, the user is encouraged to try to correct the interference by one or more of the following measures:

- Reorient or relocate the receiving antenna.
- Increase the separation between the equipment and receiver.
- Connect the equipment into an outlet on a circuit different from that to which the receiver is connected.
- Consult the dealer or an experienced radio/TV technician for help.

FCC WARNING:

Changes or modifications not expressly approved by the party responsible for compliance could void the user's authority to operate the equipment.

► For vehicles sold in Canada

NOTE:

Operation is subject to the following two conditions: (1) this device may not cause interference, and (2) this device must accept any interference, including interference that may cause undesired operation of the device.

⚠ CAUTION

■ **When inspecting or replacing tires**

Observe the following precautions to prevent accidents. Failure to do so may cause damage to parts of the drive train, as well as dangerous handling characteristics, which may lead to fatal or injury accidents.

- Do not mix tires of different makes, models, tread patterns or treadwear.
- Do not use tire sizes other than those recommended by Lexus.
- Do not mix radial, bias-belted, or bias-ply tires.
- Do not mix summer, all season and winter tires.
- Do not use tires that have been used on another vehicle.
Do not use tires if you do not know how they were used previously.

■ **When initializing the tire pressure warning system**

Do not push the tire pressure warning reset switch without first adjusting the tire inflation pressure to the specified level. Otherwise, the tire pressure warning light may not come on even if the tire inflation pressure is low, or it may come on when the tire inflation pressure is actually normal.

 NOTICE

■ **Repairing or replacing tires, wheels and tire pressure warning valves and transmitters**

When removing or fitting the wheels, tires or the tire pressure warning valve and transmitter, contact your Lexus dealer as the tire pressure warning valve and transmitter may be damaged if not handled correctly.

■ **To avoid damaging the tire pressure warning valves and transmitters**

Do not use liquid sealants on flat tires.

■ **Driving on rough roads**

Take particular care when driving on roads with loose surfaces or potholes.

These conditions may cause losses in tire inflation pressure, reducing the cushioning ability of the tires. In addition driving on rough roads may cause damage to the tires themselves, as well as the vehicle's wheels and body.

■ **Low profile tires (245/40R18, P245/40R18 and 245/40ZR18 tires)**

Low profile tires may cause greater damage than usual to the tire wheel when receiving impact from the road surface. Therefore pay attention to the following:

- Be sure to use proper tire inflation pressure. If tires are under-inflated, they may be damaged more severely.
- Avoid hot holes, uneven pavement, curbs and other road hazards. Failure to do so can lead to severe tire and wheel damage.

■ **If tire inflation pressures become low while driving**

Do not continue driving, or your tires and/or wheels may be ruined.

4-3. Do-it-yourself maintenance

Tire inflation pressure

■ Tire inflation pressure

The recommended cold tire inflation pressure and tire size is displayed on the tire and loading information label. (→P. 550)



TIRE AND LOADING INFORMATION			INFORMATION SUR LES PNEUS ET LE CHARGEMENT		
SEATING CAPACITY: TOTAL X FRONT X REAR X The combined weight of occupants and cargo should never exceed XXX kg or XXX lb.			NOMBRE DE PLACES ASSISES: TOTAL X AVANT X ARRIERE X Le poids total des occupants et du chargement ne doit jamais être supérieur à XXX kg ou XXX lb.		
TIRE	SIZE	COLD TIRE PRESSURE	PNEUS	DIMENSION	PRESSION DE GONFLAGE À FROID
FRONT	XXXXXXXXXX	XXXkPa,XXPSI	AVANT	XXXXXXXXXX	XXXkPa,XXPSI
REAR	XXXXXXXXXX	XXXkPa,XXPSI	ARRIERE	XXXXXXXXXX	XXXkPa,XXPSI
SPARE	XXXXXXXXXX	XXXkPa,XXPSI	SECOURS	XXXXXXXXXX	XXXkPa,XXPSI
SEE OWNER'S MANUAL FOR ADDITIONAL INFORMATION			POUR DE PLUS AMPLES INFORMATIONS, VOIR LE MANUEL DU PROPRIÉTAIRE		

ILY43G033

FarmaSOS.com

■ Inspection and adjustment procedure



- 1 Tire valve
- 2 Tire pressure gauge

STEP 1 Remove the tire valve cap.

STEP 2 Press the tip of the tire pressure gauge onto the tire valve.

STEP 3 Read the pressure using the graduations of the gauge.

STEP 4 If the tire inflation pressure is not within the recommended levels, adjust tire pressure.

If you add too much air, press the center of the valve to lower.

STEP 5 After completing the tire inflation pressure measurement and adjustment, apply soapy water to the valve and check for leakage.

STEP 6 Reinstall the tire valve cap.

■ Tire inflation pressure check interval

You should check tire inflation pressure every 2 weeks, or at least once a month. If equipped, do not forget to check the spare.

■ Effects of incorrect tire inflation pressure

Driving with incorrect tire inflation pressure may result in the following:

- Reduced fuel efficiency
- Reduced driving comfort and tire life
- Reduced safety
- Damage to the drive train

If a tire needs frequent refilling, have it checked by your Lexus dealer.

■ Instructions for checking tire inflation pressure

When checking tire inflation pressure, observe the following:

- Check only when the tires are cold.
If your vehicle has been parked for at least 3 hours and has not been driven for more than 1 mile or 1.5 km, you will get an accurate cold tire inflation pressure reading.
- Always use a tire pressure gauge.
The appearance of the tire can be misleading. In addition, tire inflation pressures that are even just a few pounds off can degrade ride and handling.
- Do not bleed or reduce tire inflation pressure after driving. It is normal for the tire inflation pressure to be higher after driving.
- Never exceed the vehicle capacity weight.
Passengers and luggage weight should be placed so that the vehicle is balanced.

 CAUTION

■ **Proper inflation is critical to save tire performance**

Keep your tires properly inflated. Otherwise, the following conditions may occur and result in an accident causing death or serious injury.

- Excessive wear
- Uneven wear
- Poor handling
- Possibility of blowouts resulting from overheated tires
- Poor sealing of the tire bead
- Wheel deformation and/or tire separation
- A greater possibility of tire damage from road hazards

 NOTICE

■ **When inspecting and adjusting tire inflation pressure**

Be sure to reinstall the tire valve caps.

Without the valve caps, dirt or moisture could get into the valve and cause air leakage, which could result in an accident. If the caps have been lost, replace them as soon as possible.

امداد خودرو فارما

تلفن شبانه روزی: ۰۸۵ ۲۱۸۸۴۲۰۸۵

FarmaSOS.com

Wheels

If a wheel is bent, cracked or heavily corroded, it should be replaced. Otherwise, the tire may separate from the wheel or cause loss of handling control.

■ Wheel selection

When replacing wheels, care should be taken to ensure that they are equivalent to those removed in load capacity, diameter, rim width, and offset.

Replacement wheels are available at your Lexus dealer.

Lexus does not recommend using:

- Wheels of different sizes or types
- Used wheels
- Bent wheels that have been straightened

■ Aluminum wheel precautions

- Use only Lexus wheel nuts and wrenches designed for use with your aluminum wheels.
- After rotating, repairing or changing your tires, check that the wheel nuts are still tight after driving 1000 miles (1600 km).
- Be careful not to damage the aluminum wheels when using tire chains.
- Use only Lexus genuine balance weights or equivalent when balancing your wheels.

■ When replacing wheels

The wheels of your Lexus are equipped with tire pressure warning valves and transmitters that allow the tire pressure warning system to provide advanced warning in the event of a loss in tire inflation pressure. Whenever wheels are replaced, the tire pressure warning valves and transmitters must be installed. (→P. 422)

CAUTION

■ When replacing wheels

- Do not use wheels that are a different size from those recommended in the Owner's Manual, as this may result in loss of handling control.
- Never use an inner tube in a leaking wheel which is designed for a tubeless tire. Doing so may result in an accident, causing death or serious injury.

NOTICE

■ Replacing tire pressure warning valves and transmitters

- Because tire repair or replacement may affect the tire pressure warning valves and transmitters, make sure to have tires serviced by your Lexus dealer or other qualified service shop. In addition, make sure to purchase your tire pressure warning valves and transmitters at your Lexus dealer.
- Ensure that only genuine Lexus wheels are used on your vehicle. Tire pressure warning valves and transmitters may not work properly with non-genuine wheels.

4-3. Do-it-yourself maintenance

Air conditioning filter

The air conditioning filter must be cleaned or changed regularly to maintain air conditioning efficiency.

■ Removal method

STEP 1 Set the air conditioning system to recirculated mode.

The air conditioning filter case cannot be removed with the system in the outside air mode.

STEP 2 Turn the "ENGINE START STOP" switch to OFF.

STEP 3

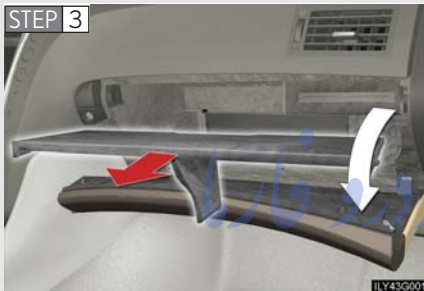

Open the glove box and remove the partition.

STEP 4

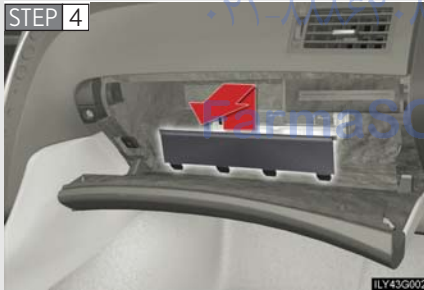

Remove the filter cover.

STEP 5

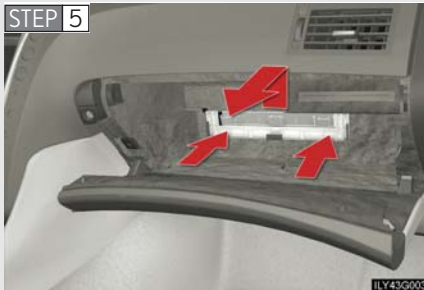

Press the tabs and remove the filter case.

■ Cleaning method



If the filter is dirty, clean by blowing compressed air through the filter from the downward side.

Hold the air gun 2 in. (5 cm) from the filter and blow for approximately 2 minutes at 73 psi (500 kPa, 5.1 kgf/cm² or bar).

If it is not available, have the filter cleaned by your Lexus dealer.

■ Replacement method

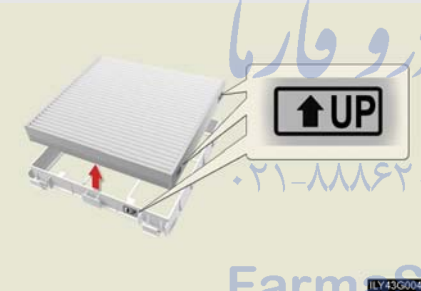

Remove the air conditioning filter from the filter case and replace it with a new one.

The "↑UP" marks shown on the filter and the filter case should be pointing up.

FarmasOS.com

■ Checking interval

Inspect and replace the air conditioning filter according to the maintenance schedule. In dusty areas or areas with heavy traffic flow, early replacement may be required. (For scheduled maintenance information, refer to the “Warranty and Services Guide/Owner’s Manual Supplement/Scheduled Maintenance”.)

■ If air flow from the vents decreases dramatically

The filter may be clogged. Check the filter and replace if necessary.

NOTICE

■ To prevent damage to the system

- When using the air conditioning system, make sure that a filter is always installed.
- When cleaning the filter, do not clean the filter with water.

تلفن شبانه روزی: ۰۲۱-۸۸۶۲۰۸۵

FarmaSOS.com

4-3. Do-it-yourself maintenance

Electronic key battery

Replace the battery with a new one if it is discharged.

■ You will need the following items:

- Flathead screwdriver
- Small Phillips-head screwdriver
- Lithium battery (CR1632)

■ Replacing the battery

STEP 1

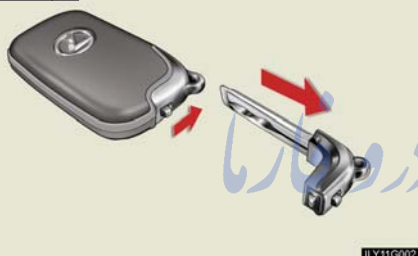

Take out the mechanical key.

STEP 2



Remove the cover.

STEP 3



Remove the depleted battery.

Insert a new battery with the “+” terminal facing up.

■ If the electronic key battery is discharged

The following symptoms may occur.

- The smart access system with push-button start and wireless remote control will not function properly.
- The operational range is reduced.

■ Use a CR1632 lithium battery

- Batteries can be purchased at your Lexus dealer, jewelers, or camera stores.
- Replace only with the same or equivalent type recommended by your Lexus dealer.
- Dispose of used batteries according to the local laws.

CAUTION

■ Removed battery and other parts

Keep away from children.

These parts are small and if swallowed by a child they can cause choking.

NOTICE

■ For normal operation after replacing the battery

Observe the following precautions to prevent accidents.

- Always work with dry hands.
Moisture may cause the battery to rust.
- Do not touch or move any other components inside the electronic key.
- Do not bend the battery terminals.

4-3. Do-it-yourself maintenance

Checking and replacing fuses

If any of the electrical components do not operate, a fuse may have blown. If this happens, check and replace the fuses as necessary.

STEP 1 Turn the “ENGINE START STOP” switch to OFF.

STEP 2 Remove the engine compartment cover if necessary.

→P. 408

STEP 3 Open the fuse box cover.

■ Engine compartment

► Type A

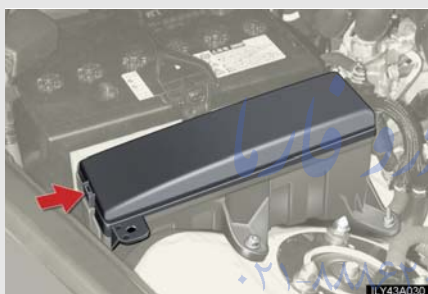

Push the tabs in and lift the lid off.

► Type B



Push the tabs in and lift the lid off.

■ Front controller in the engine compartment fuse box
(engine compartment: type B)

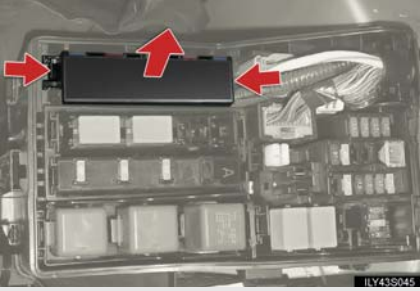

Lift the lid off while pushing the tabs on either side.

■ Left side instrument panel



Remove the lid.

■ Right side instrument panel



Remove the lid.

■ Luggage compartment



Remove the cover.

■ Luggage compartment (vehicles with active stabilizer suspension system)



Remove the lid.

STEP 4 After a system failure, see “Fuse layout and amperage ratings” (→P. 447) for details about which fuse to check.

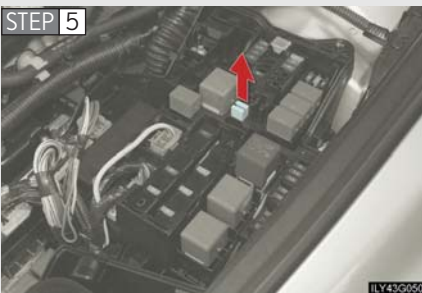

STEP 5

Remove the fuse with the pull-out tool.

STEP 6 Check if the fuse has blown.

► Type A

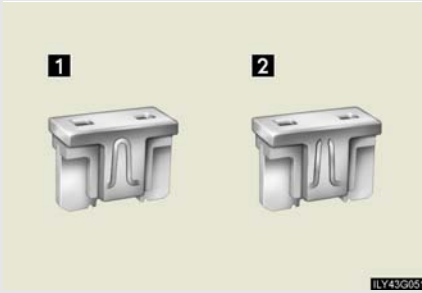
**1** Normal fuse**2** Blown fuse

Replace it with one of an appropriate amperage rating. The amperage rating can be found on the fuse box lid.

► Type B

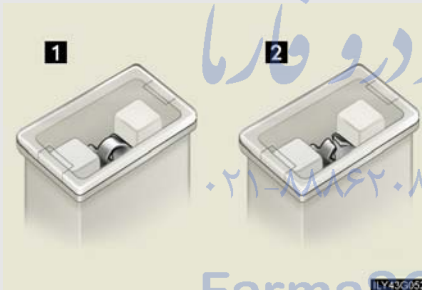
**1** Normal fuse**2** Blown fuse

Replace it with one of an appropriate amperage rating. The amperage rating can be found on the fuse box lid.

► Type C

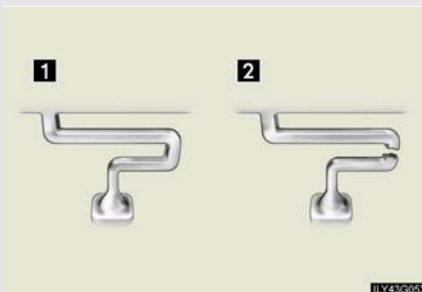
**1** Normal fuse**2** Blown fuse

Contact your Lexus dealer.

► Type D

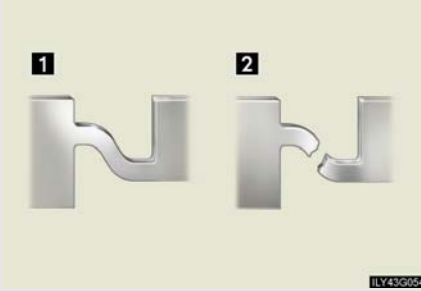

1 Normal fuse

2 Blown fuse

Contact your Lexus dealer.

امداد خودرو فارما

تلفن شبانه روزی: ۰۲۱-۸۸۸۶۲۰۸۵

FarmaSOS.com

Fuse layout and amperage ratings

■ Engine compartment (Type A)

► GS460

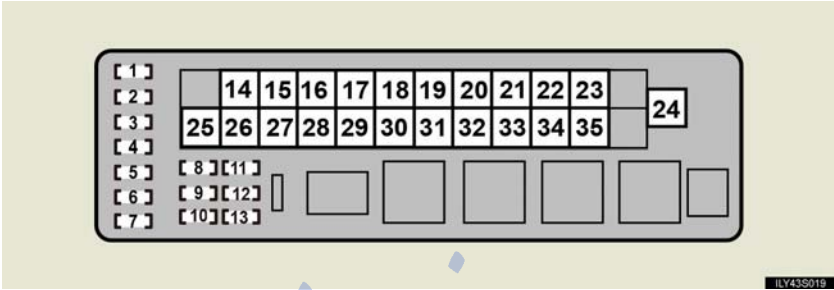

Fuse		Ampere	Circuit
1	ECU-B	10	VGRS, EPS, driver's seat switch module, Lexus link system ECU
2	ABS MAIN3	10	Electronically controlled brake system
3	TURN-HAZ	15	Turn signal lights, emergency flashers
4	IG2 MAIN	20	IG2, GAUGE and IGN
5	RAD NO.2	30	Audio system
6	D/C CUT	20	DOME and MPX-B
7	RAD NO.1	30	Audio system

Fuse		Ampere	Circuit
8	MPX-B	10	Multiplex communication system, front controller, door control system (power door lock system, door courtesy lights, power windows, power rear view mirror control system, outside rear view mirror heaters), power seat system, steering sensors, electronically controlled brake system, tilt and telescopic steering wheel, gauges and meters, combination switch
9	DOME	10	Foot lights, vanity lights, gauges and meters, steering spot light, steering switch illumination, rear personal lights, automatic transmission selector lever spot light, front personal lights
10	CDS	10	Noise filter
11	ABS MAIN2	10	Electronically controlled brake system
12	ABS MOTOR	30	ABS
13	ABS MAIN1	10	Capacitor
14	BATT-E/G	60	FR CTRL BATT, ETCS, ALT-S, A/F HTR and INJ2
15	P/I-B	60	EFI NO.1, F/PMP and INJ
16	ABS1	50	VDIM
17	RH J/B-B	30	AM2, DOOR FR and DOOR RR

	Fuse	Ampere	Circuit
18	VGRS	40	VGRS
19	MAIN	30	H-LP R LWR and H-LP L LWR
20	STARTER	30	Starting system
21	LH J/B-B	30	FL DOOR, RL DOOR and RAD NO.3
22	VVT	40	Electronic engine control system
23	EPS	80	EPS
24	ALT	180	RH J/B-AM, LH J/B-AM, E/G-AM, RR JB, HEATER, DEFOG, FAN1, FAN2, ABS2, ABS MOTOR, ABS MAIN1, and ABS MAIN2
25	RH J/B-AM	80	AM1, OBD, STOP SW, TI&TE, PWR OUTLET, FR P/SEAT RH, STR LOCK, ECU-IG RH, RH-IG, ACC, CIG, SECURITY, FR S/HTR RH and AIR SUS
26	FAN3	80	Electric cooling fans
27	LH J/B-AM	80	S/ROOF, P/SEAT, TV, FL S-HTR, ECU-IG L, WIP, H-LP LVL, LH-IG, FUEL OPN, A/C, PANEL, LH-B and TRK OPN
28	ABS2	30	ABS
29	DEFFOG	50	Rear window defogger, noise filter
30	CDS	40	CDS

	Fuse	Ampere	Circuit
31	FAN1	40	Electric cooling fans
32	HEATER	50	Air conditioning system
33	FAN2	40	Electric cooling fans
34	E/G-AM	60	H-LP CLN, FR CTRL ALT, A/C COMP and STB-AM
35	RR J/B	80	STOP LP R, STOP LP L, RR-B, RR TAIL, RR FOG, RR-IG1, PSB, and RR S/SHADE

امداد خودرو فارما

تلفن شبانه روزی: ۰۲۱-۸۸۶۲۰۸۵

FarmaSOS.com

► GS350

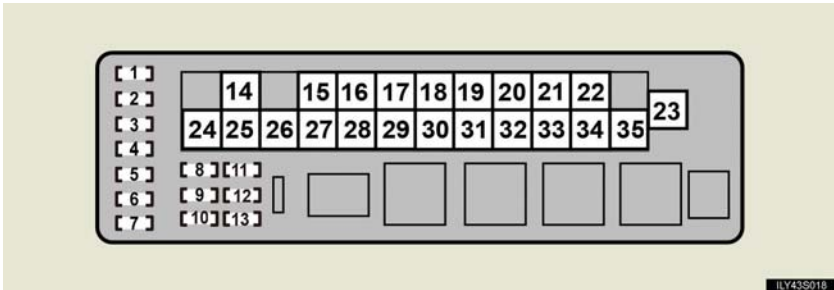

Fuse		Ampere	Circuit
1	ECU-B	10	VGRS, EPS, driver's seat switch module, Lexus link system ECU
2	ABS MAIN3	25	Electronically controlled brake system
3	TURN-HAZ	15	Turn signal lights, emergency flashers
4	IG2 MAIN	20	IG2, GAUGE and IGN
5	RAD NO.2	30	Audio system
6	D/C CUT	20	DOME and MPX-B
7	RAD NO.1	30	Audio system
8	MPX-B	10	Multiplex communication system, front controller, door control system (power door lock system, door courtesy lights, power windows, power rear view mirror control system, outside rear view mirror heaters), power seat system, steering sensors, electronically controlled brake system, tilt and telescopic steering wheel, gauges and meters, combination switch

4-3. Do-it-yourself maintenance

Fuse		Ampere	Circuit
9	DOME	10	Foot lights, vanity lights, gauges and meters, steering spot light, steering switch illumination, rear personal lights, automatic transmission selector lever spot light, front personal lights
10	CDS	10	Noise filter
11	ABS MAIN2	10	Electronically controlled brake system
12	ABS MOTOR	30	ABS
13	ABS MAIN1	10	Capacitor
14	BATT-E/G	60	FR CTRL BATT, ETCS, ALT-S and A/F HTR
15	ABS1	50	VDIM system
16	RH J/B-B	30	AM2, DOOR FR and DOOR RR
17	VGRS	40	VGRS
18	MAIN	30	H-LP R LWR and H-LP L LWR
19	STARTER	30	Starting system
20	LH J/B-B	30	FL DOOR, RL DOOR and RAD NO.3
21	P/I-B	60	EFI NO.1, F/PMP and INJ
22	EPS	80	EPS
23	ALT	150	RH J/B-AM, LH J/B-AM, E/G-AM, RR JB, HEATER, DEFOG, FAN1, FAN2, ABS2, ABS MOTOR, ABS MAIN1, and ABS MAIN2

Fuse		Ampere	Circuit
24	RR J/B	80	STOP LP R, STOP LP L, RR-B, RR TAIL, RR FOG, RR-IG1, PSB, and RR S/SHADE
25	GLW PLG1	50	Starting system
26	RH J/B-AM	80	AM1, OBD, STOP SW, TI&TE, PWR OUTLET, FR P/SEAT RH, STR LOCK, ECU-IG RH, RH-IG, ACC, CIG, SECURITY, FR S/HTR RH and AIR SUS
27	ABS2	30	ABS
28	DEFFOG	50	Rear window defogger, noise filter
29	CDS	40	CDS
30	FAN1	40	Electric cooling fans
31	HEATER	50	Air conditioning system
32	GLW PLG2	50	Starting system
33	E/G-AM	60	H-LP CLN, FR CTRL ALT, A/C COMP and STB-AM
34	LH J/B-AM	80	S/ROOF, P/SEAT, TV, FL S-HTR, ECU-IG L, WIP, H-LP LVL, LH-IG, FUEL OPN, A/C, PANEL, LH-B and TRK OPN
35	FAN2	60	Electric cooling fans

■ Engine compartment (Type B)

► GS460

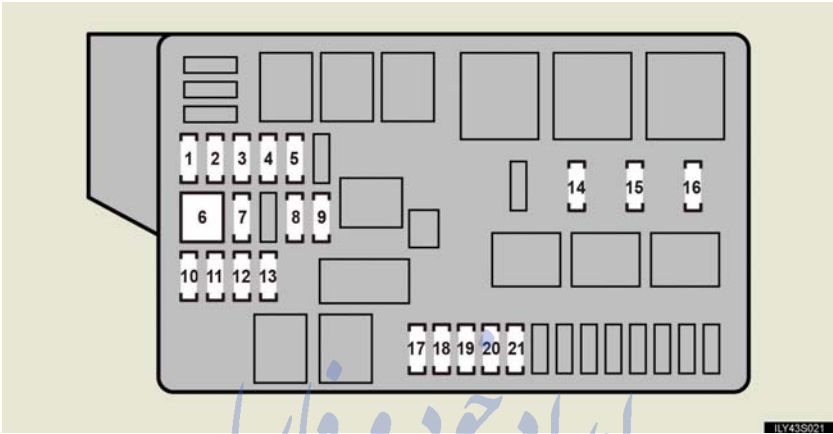

Fuse	Ampere	Circuit
1	25	H-LP UPR and HORN
2	15	Exhaust system
3	10	Electronic throttle control system
4	7.5	Charging system
5	25	Multiport fuel injection system/ sequential multiport fuel injection system
6	30	Headlight cleaner
7	30	_____
8	25	_____
9	30	FR TAIL, FR FOG and WASHER

Fuse		Ampere	Circuit
10	IG2	10	Ignition system, noise filter and ECT ECU
11	EFI NO.2	10	Fuel system, exhaust system, multiport fuel injection system/sequential multiport fuel injection system, electronic engine control system, leak detection pump
12	H-LP R LWR	15	Headlight low beam (right)
13	H-LP L LWR	15	Headlight low beam (left)
14	F/PMP	25	Fuel system
15	EFI	25	Multiport fuel injection system/sequential multiport fuel injection system, ECT ECU
16	INJ	25	Multiport fuel injection system/sequential multiport fuel injection system
17	H-LP UPR	15	Headlight high beams
18	HORN	10	Horns
19	WASHER	20	Windshield wipers and washer
20	FR TAIL	10	Parking lights, side marker light
21	FR FOG	15	Front fog lights

► GS350

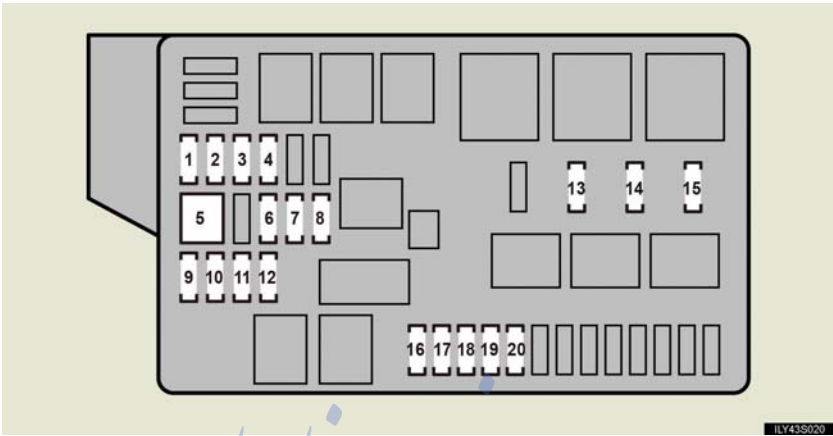

ILY43S020

	Fuse	Ampere	Circuit
1	FR CTRL-B	25	H-LP UPR and HORN
2	A/F	15	Exhaust system
3	ETCS	10	Electronic throttle control system
4	ALT-S	7.5	Charging system
5	H-LP CLN	30	Headlight cleaner
6	A/C COMP	7.5	Air conditioning system
7	DEICER	25	—
8	FR CTRL-AM	30	FR TAIL, FR FOG and WASHER
9	IG2	10	Ignition system and noise filter
10	EFINO.2	10	Fuel system and exhaust system

	Fuse	Ampere	Circuit
11	H-LP R LWR	15	Headlight low beam (right)
12	H-LP L LWR	15	Headlight low beam (left)
13	F/PMP	25	Fuel system
14	EFI NO.1	25	Multiport fuel injection system/ sequential multiport fuel injection system
15	INJ	20	Multiport fuel injection system/ sequential multiport fuel injection system
16	H-LP HI	15	Headlight high beams
17	HORN	10	Horns
18	WASHER	20	Windshield wipers and washer
19	FR TAIL	10	Parking lights, side marker light
20	FR FOG	15	Front fog lights

FarmaSOS.com

■ Left side instrument panel

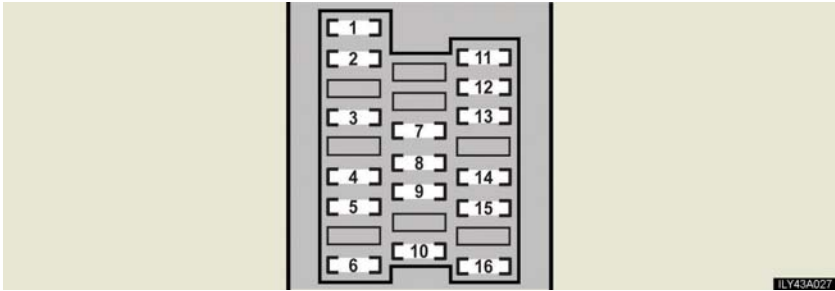

Fuse		Ampere	Circuit
1	FR P/SEAT LH	30	Power seat system
2	A/C	7.5	Air conditioning system
3	TV	7.5	Audio system, air conditioning system, rear view monitor system
4	TRK OPN	10	Trunk lid opener
5	LH-B	10	Theft deterrent system
6	S/ROOF	25	Moon roof
7	PANEL	7.5	Steering switch illumination, audio system, glove box light, automatic transmission selector lever illumination, console box light, adaptive variable suspension switch illumination, cigarette lighter illumination, air conditioning system, VSC OFF switch illumination, driving pattern selector switch, seat heater or heated and ventilated seat switches, register ILL RH, register ILL LH, fuel filler door and trunk lid opener switch illumination, D-SW module

Fuse		Ampere	Circuit
8	FUEL OPN	10	Fuel filler door opener, trunk lid opener
9	ECU-IG LH	10	VDIM, electronically controlled brake system, yaw rate and G sensor, steering sensor, cruise control system, dynamic radar cruise control system, EPS, VGRS, rear view monitor system, four-wheel drive system, front controller, moon roof, rain sensor
10	FR S/HTR LH	15	Seat heaters and ventilators
11	RR DOOR LH	20	Rear left door control system (power door lock system, door courtesy light, power window)
12	FR DOOR LH	20	Front left door control system (power door lock system, power rear view mirror control system, door courtesy light, outside rear view mirror heater, power window)
13	RAD NO.3	10	Audio system
14	H-LP LVL	7.5	AFS, automatic headlight leveling control system

Fuse		Ampere	Circuit
15	LH-IG	10	Charging system, headlight cleaners, exhaust gas sensor, rear window defogger, electric cooling fans, rear left door control system, front left door control system, emergency flashers, automatic transmission, seat belt pretensioners, Intuitive parking assist, power window
16	FR WIP	30	Windshield wipers and washer

امداد خودرو فارما

تلفن شبانه روزی: ۰۲۱-۸۸۶۲۰۸۵

FarmaSOS.com

■ Right side instrument panel

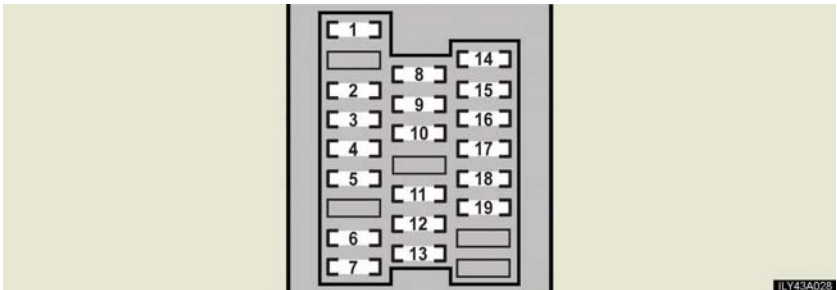

Fuse		Ampere	Circuit
1	FR P/SEAT RH	30	Power seat system
2	OBD	7.5	On-board diagnosis system
3	STOP SW	7.5	Stop/tail lights, multi-port fuel injection system/sequential multiport fuel injection system, starting system, electronically controlled brake system, VSC system, shift lock system, ECT ECU
4	AM1	7.5	_____
5	TI&TE	20	Tilt and telescopic steering wheel, multiplex communication system
6	SECURITY	7.5	Smart access system with push-button start
7	STR LOCK	25	Steering lock system
8	GAUGE	7.5	Gauges and meters

4-3. Do-it-yourself maintenance

Fuse		Ampere	Circuit
9	IGN	10	Multi-port fuel injection system/ sequential multiport fuel injection system, SRS airbag system, stop/tail lights, steering lock system, electroni- cally controlled brake system, Lexus link system ECU, occupant classifica- tion system ECU
10	ACC	7.5	Multiplex communication system, smart access system with push-but- ton start, rear view monitor system, audio system, air conditioning system, Lexus link system ECU
11	CIG	15	Cigarette lighter
12	PWR OUTLET	15	Power outlet
13	AIR SUS	20	Adaptive variable suspension system
14	RR DOOR RH	20	Rear right door control system (power door lock system, door cour- tesy light, power window)
15	FR DOOR RH	20	Front right door control system (power door lock system, power rear view mirror control system, door courtesy light, outside rear view mir- ror heater, power window), multiplex communication system

	Fuse	Ampere	Circuit
16	AM2	7.5	Starting system
17	RH-IG	7.5	Seat heater switches, front right door control system, rear right door control system, capacitor, combination switch, seat belt pretensioners, shift lever switch, power window
18	FR S/HTR RH	15	Seat heaters and ventilators
19	ECU-IG RH	10	Tilt and telescopic steering, combination switch, multiplex communication system, power seat, smart entry & start system, air conditioning system, audio system, shift lock system

تلفن شبانه روزی: ۰۲۱-۸۸۶۲۰۸۵

FarmaSOS.com

Luggage compartment

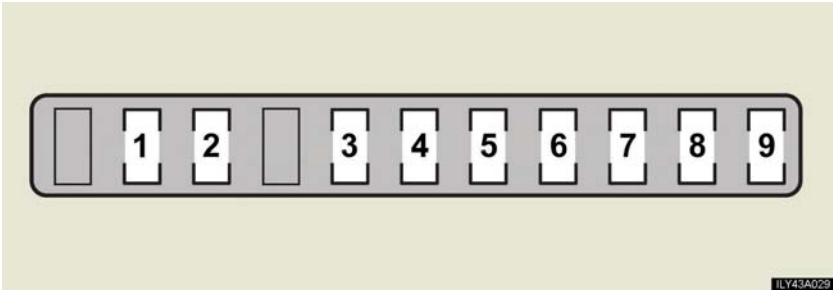

Fuse		Ampere	Circuit
1	RR S/SHADE	7.5	Rear sunshade
2	PSB	30	Pre-collision seat belt
3	RR-IG2	10	_____
4	RR-IG1	10	Pre-collision seat belt, seat belt pre-tensioners, A/P UNIT, rear sunshade
5	RR-B	10	Trunk light, noise filter
6	RR FOG	7.5	_____
7	STOP LPL	10	Stoplights, back-up light
8	STOP LPR	10	High mounted stoplights
9	RR TAIL	10	Tail lights, license plate lights, rear side marker lights

■ Luggage compartment (vehicles with active stabilizer suspension system)

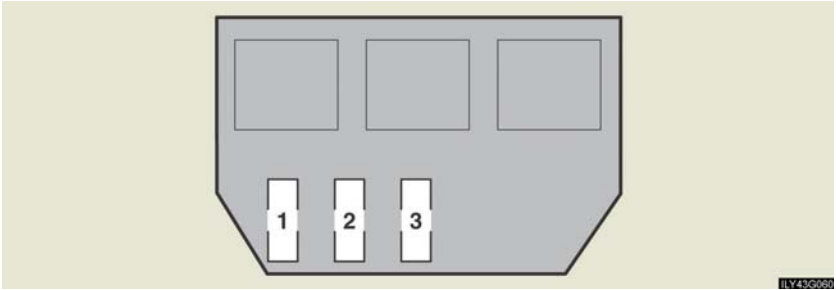

	Fuse	Ampere	Circuit
1	STB FR	50	Front stabilizer
2	STB RR	30	Rear stabilizer
3	STB DC/DC	30	DC/DC converter

■ After a fuse is replaced

- If the lights do not turn on even after the fuse has been replaced, a bulb may need replacement. (→P. 470)
- If the replaced fuse blows again, have the vehicle inspected by your Lexus dealer.

■ If there is an overload in the circuits

The fuses are designed to blow before the entire wiring harness is damaged.

 CAUTION

■ To prevent system breakdowns and vehicle fire

Observe the following precautions.

Failing to do so may cause damage, and possibly a fire or injury.

- Never use a fuse of a higher amperage rating than indicated, or use any other object in place of a fuse.
- Always use a genuine Lexus fuse or equivalent.
Never replace a fuse with a wire, even as a temporary fix.
This can cause extensive damage or even fire.
- Do not modify fuses or the fuse box.

 NOTICE

■ Before replacing fuses

Have the cause of electrical overload determined and repaired by your Lexus dealer.

تلفن شبانه روزی: +۲۱-۸۸۶۲۰۸۵

FarmaSOS.com

4-3. Do-it-yourself maintenance

Headlight aim

Gauges

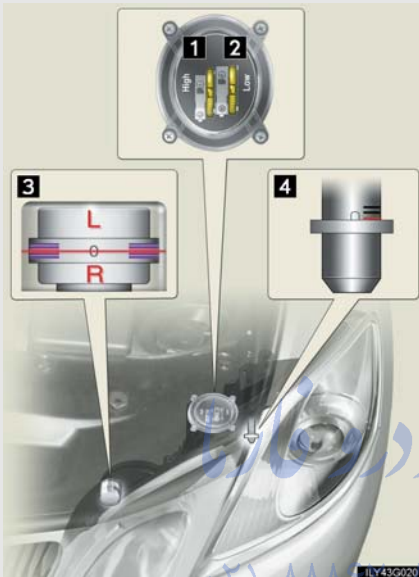

- 1 High beam vertical position
- 2 Low beam vertical position
- 3 High beam horizontal position
- 4 Low beam horizontal position

Adjustment bolts



- 1 High beam horizontal adjustment
- 2 High beam vertical adjustment
- 3 Low beam adjustment bolt A
- 4 Low beam adjustment bolt B

■ Before checking the headlight aim

- STEP 1** Make sure the vehicle has a full tank of gas and the area around the headlight is not deformed.
- STEP 2** Park the vehicle on level ground.
- STEP 3** Sit in the driver's seat.
- STEP 4** Bounce the vehicle several times.

■ Adjusting the headlight aim

► Low beam (vertical adjustment)



Using a Phillips-head screwdriver, turn adjustment bolt A so that the bubble is within the 2 center lines.

Remember the turning direction and the number of turns.



Turn bolt B the same number of turns and in the same direction as step 1.

► Low beam (horizontal adjustment)

Turn adjustment bolt A so that the red line on the gauge is in the middle of the "0" mark (within the blue lines to either side of the gauge).

► High beam (vertical and horizontal adjustment)

Turn each adjustment bolt in either direction so that the bubble in within the 2 center lines (vertical), and the red line on the gauge is in the middle of the "0" mark (within the blue lines to either side of the gauge) (horizontal).

If you feel that there is a large deviation, have the headlight aim adjusted at a Lexus dealer.

امداد خودرو فارما

تلفن شبانه روزی: ۰۲۱-۸۸۶۲۰۸۵

FarmaSOS.com

4-3. Do-it-yourself maintenance

Light bulbs

You may replace the following bulbs yourself. For more information about replacing other light bulbs, contact your Lexus dealer.

■ Prepare a replacement light bulb

Check the wattage of the light bulb being replaced. (→P. 552)

■ Remove the engine compartment cover if necessary

→P. 408

■ Front bulb locations



■ Rear bulb locations



Replacing light bulbs

■ Headlight high beam

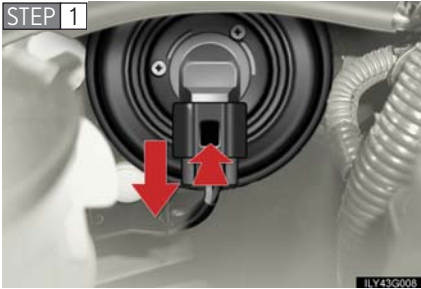

Unplug the connector while depressing the lock release.

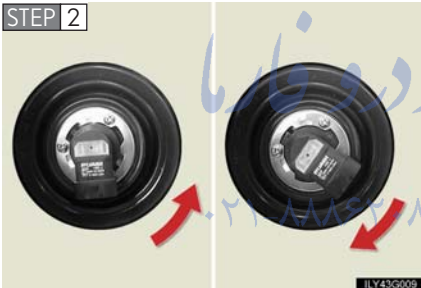

Turn the bulb base counterclockwise to remove it.

FarmaSOS.com

■ Parking light

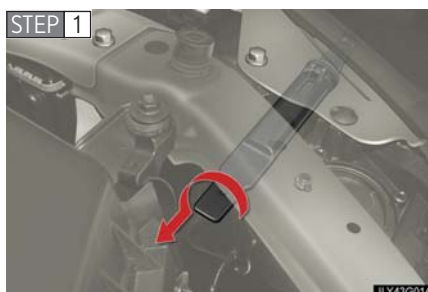

Turn the bulb base counterclockwise.



Remove the light bulb.

■ Back-up light

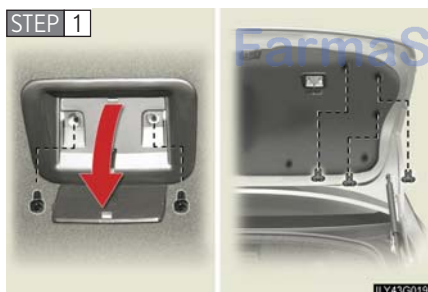

Open the trunk lid. Remove the trunk handle and panel cover clips.

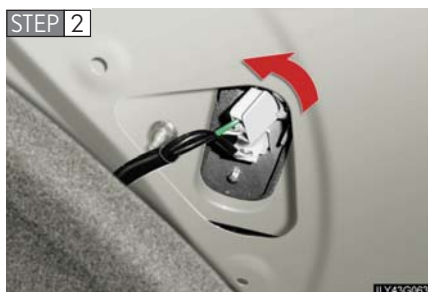

Partly remove the trunk panel cover and turn the bulb bases counterclockwise.

STEP 3

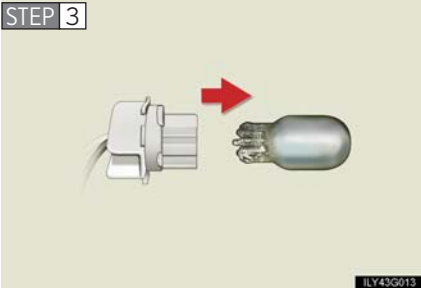

Remove the light bulb.

Rear turn signal light

STEP 1



Open the trunk lid and remove the cover.

STEP 2

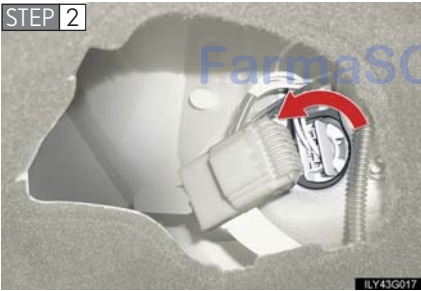

Turn the bulb base counterclockwise.

STEP 3

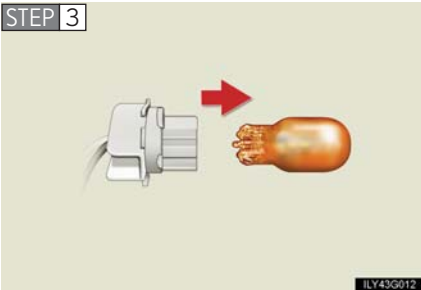

Remove the light bulb.

■ Bulbs other than the above

If any of the bulbs listed below has burnt out, have your Lexus dealer replace it.

- Headlight low beams (high-intensity discharge bulbs)
- Fog lights
- Front turn signal lights
- Front side marker lights
- Side turn signal lights
- Tail/stop lights
- Tail lights
- Rear side marker lights
- High mounted stoplight
- License plate lights

■ Condensation build-up on the inside of the lens

Contact your Lexus dealer for more information in the following situations. Temporary condensation build-up on the inside of the headlight lens does not indicate a malfunction.

- Large drops of water are built up on the inside of the lens.
- Water has built up inside the headlight.

■ LED light bulbs

The side turn signal lights, tail, tail/stop and high mounted stoplights consist of a number of LEDs. If any of the LEDs burn out, take your vehicle to your Lexus dealer to have the light replaced.

If two or more LEDs in a stoplight burn out, your vehicle may not conform to local laws (SAE).

■ High-intensity discharge (HID) headlights

If voltage to the high-intensity discharge bulbs is insufficient, the light may not come on, or may go out temporarily. The high-intensity discharge bulbs will come on when normal power is restored.

⚠ CAUTION**■ Replacing light bulbs**

- Turn off the headlights. Do not attempt to replace the bulb immediately after turning off the headlights.
The bulbs become very hot and may cause burns.
- Do not touch the glass portion of the light bulb with bare hands. Hold the bulb by the plastic or metal portion.
If the bulb is scratched or dropped it may blow out or crack.
- Fully install light bulbs and any parts used to secure them. Failing to do so may result in heat damage, fire, or water entering the headlight unit. This may damage the headlights or cause condensation to build up on the lens.
- Do not attempt to take apart or repair the low beam discharge headlight bulbs, connectors, power supply circuits, or related components.
Doing so could result in electric shock and death or serious injury.

■ High-intensity discharge (HID) headlights

- Contact your Lexus dealer before replacing high-intensity discharge headlights (including light bulbs).
- Do not touch the high-intensity discharge headlight's high voltage socket when the headlights are turned on.
An extremely high voltage of 20000 V will be discharged and could result in death or serious injury by electric shock.

■ To prevent damage or fire

Make sure bulbs are fully seated and locked.

امداد خودرو فارما

تلفن شبانه روزی: ۰۲۱-۸۸۸۶۲۰۸۵

FarmaSOS.com

5-1. Essential information.....	478	5-2. Steps to take in an	emergency 488
If your vehicle needs		If a warning light turns on or a	
to be towed.....	478	warning buzzer sounds... ..	488
If you think something is		If a warning message is	
wrong	484	displayed.....	497
Fuel pump shut off		If you have a flat tire (Vehicles	
system	485	with standard tires).....	512
Event data recorder	486	If you have a flat tire (Vehicles	
		with run-flat tires).....	522
		If the engine will not start	523
		If the shift lever cannot be	
		shifted from “P”	524
		If you lose your keys	525
		If the electronic key does	
		not operate properly.....	526
		If the 12 volt battery is	
		discharged	529
		If your vehicle overheats	533
		If the vehicle becomes	
		stuck.....	536

5-1. Essential information

If your vehicle needs to be towed

If towing is necessary, we recommend having your vehicle towed by your Lexus dealer or a commercial towing service, using a lift-type truck or a flat bed truck.

Use a safety chain system for all towing, and abide by all state/provincial and local laws.

If towing from the rear, the wheels and axle on the ground must be in good condition.

If they are damaged, use a towing dolly or flat bed truck.

Before towing

The following may indicate a problem with your automatic transmission. Contact your Lexus dealer before towing.

- The engine is running, but the vehicle will not move.
- The vehicle makes an abnormal sound. تلفن شبانه روزی: ۰۲۱-۸۸۸۸۸۸۸۸

Emergency towing

If a tow truck is not available, in an emergency your vehicle may be temporarily towed using a cable or chain secured to the emergency towing eyelet. This should only be attempted on hard, surfaced roads for short distances at low speeds.

A driver must be in the vehicle to steer and operate the brakes. The vehicle's wheels, drive train, axles, steering and brakes must be in good condition.

► Towing eyelet



■ Emergency towing procedure

- STEP 1** Release the parking brake.
- STEP 2** Put the shift lever in "N".
- STEP 3** The "ENGINE START STOP" switch must be in the ACCESSORY mode (engine off) or the IGNITION ON mode (engine on).

⚠ CAUTION

■ While towing

- Use extreme caution when towing the vehicle. Avoid sudden starts or erratic driving maneuvers which place excessive stress on the emergency towing eyelet and the cable or chain.
- If the engine is not running, the power assist for the brakes and steering will not function, making steering and braking more difficult.

⚠ NOTICE

■ To prevent causing serious damage to the automatic transmission

Never tow this vehicle from the front with the rear wheels (2WD models) or four wheels (4WD models) on the ground. This may cause serious damage to the automatic transmission.

Installing towing eyelet

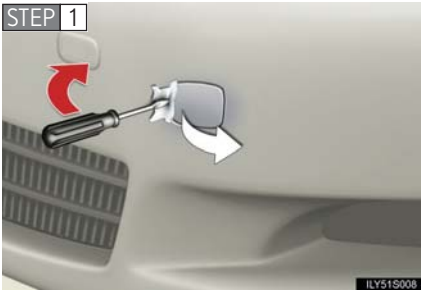

Remove the eyelet cover using a flathead screwdriver.

To protect the bodywork, place a rag between the screwdriver and the vehicle body, as shown in the illustration.



Insert the towing eyelet into the hole and tighten partially by hand.

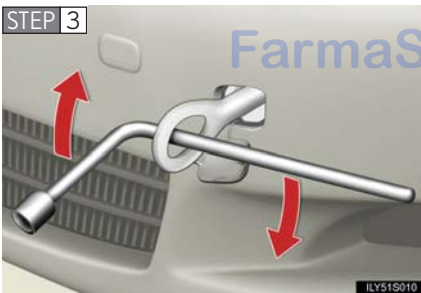

Tighten down the towing eyelet securely using a wheel nut wrench.

■ Location of the emergency towing eyelet

→P. 512

⚠ CAUTION**■ Installing towing eyelet to the vehicle**

Make sure that towing eyelet is installed securely.

If not securely installed, towing eyelet may come loose during towing. This may lead to accidents that cause serious injury or even death.

Towing with a sling-type truck**⚠ NOTICE****■ To prevent body damage**

Do not tow with a sling-type truck, either from the front or rear.

Towing with a wheel lift-type truck

► From front

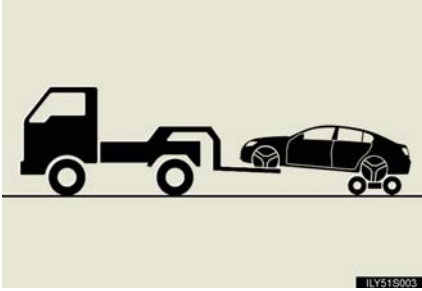

Use a towing dolly under the rear wheels.

► From rear (2WD models)

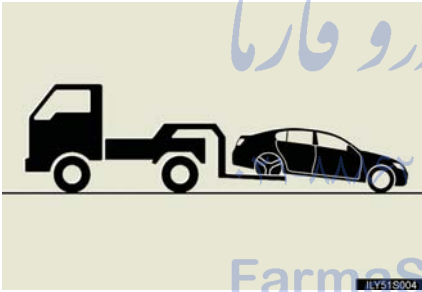

Turn the "ENGINE START STOP" switch to the ACCESSORY mode so that the steering wheel is unlocked.

تلفن شبانه روزی: ۰۲۱-۸۵۰۰۰۰۰۰

FarmaSOS.com

► From rear (4WD models)

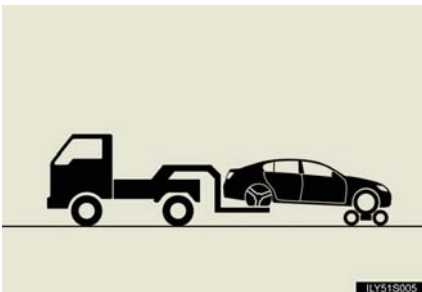

Use a towing dolly under the front wheels.

 NOTICE

■ **To prevent causing serious damage to the automatic transmission**

Never tow this vehicle from the front with the rear wheels on the ground.

■ **To prevent damaging the vehicle**

- Do not tow the vehicle with the “ENGINE START STOP” switch is OFF.
The steering lock mechanism is not strong enough to hold the front wheel straight.
- When raising the vehicle, ensure adequate ground clearance for towing at the opposite end of the raised vehicle. Without adequate clearance, the vehicle could be damaged while being towed.

Using a flat bed truck



If your Lexus is transported by a flat bed truck, it should be tied down at the locations shown in the illustration.

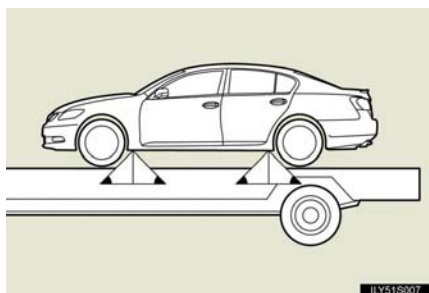

If you use chains or cables to tie down your vehicle, the angles shaded in black must be 45°.

Do not overly tighten the tie downs or the vehicle may be damaged.

5-1. Essential information

If you think something is wrong

If you notice any of the following symptoms, your vehicle probably needs adjustment or repair. Contact your Lexus dealer as soon as possible.

■ Visible symptoms

- Fluid leaks under the vehicle
(Water dripping from the air conditioning after use is normal.)
- Flat-looking tires or uneven tire wear
- Engine coolant temperature gauge needle continually points higher than normal

■ Audible symptoms

- Changes in exhaust sound
- Excessive tire squeal when cornering
- Strange noises related to the suspension system
- Pinging or other noises related to the engine

■ Operational symptoms

- Engine missing, stumbling or running rough
- Appreciable loss of power
- Vehicle pulls heavily to one side when braking
- Vehicle pulls heavily to one side when driving on a level road
- Loss of brake effectiveness, spongy feeling, pedal almost touches the floor

5-1. Essential information

Fuel pump shut off system

To minimize the risk of fuel leakage when the engine stalls or an airbag inflates upon collision, the fuel pump shut off system stops supplying fuel to the engine.

Follow the procedure below to restart the engine after the system is activated.

STEP 1] Turn the “ENGINE START STOP” switch to the ACCESSORY mode or OFF.

STEP 2] Restart the engine.

NOTICE

■ Before starting the engine

Inspect the ground under the vehicle.

If you find that fuel has leaked on to the ground, the fuel system has been damaged and is in need of repair. Do not restart the engine.

تلفن شبانه روزی: +۲۱-۸۸۶۲۰۸۵

FarmaSOS.com

5-1. Essential information

Event data recorder

Your vehicle has computers that monitor and control certain aspects of your vehicle. These computers assist in driving and maintaining optimal vehicle performance.

Besides storing data useful for troubleshooting, there is a system to record data in a crash or a near car crash event. This is called an Event Data Recorder (EDR).

In a crash or a near car crash event

The SRS airbag sensor assembly contains the EDR. In a crash or a near car crash event, this device may record some or all of the following information:

- Engine speed
- Whether the brake pedal was applied or not
- Vehicle speed
- To what extent the accelerator pedal was depressed
- Position of the automatic transmission shift lever
- Whether the driver and front passenger wore seat belts or not
- Driver's seat position
- SRS airbag deployment data
- SRS airbag system diagnostic data
- Front passenger's occupant classification

Disclosure of the data

Lexus will not disclose the data recorded in an EDR to a third party except when:

- An agreement from the vehicle's owner (or the leasing company for a leased vehicle) is obtained
- Officially requested by the police or other authorities
- Used as a defense for Lexus in a law suit
- Ordered by a court

However, if necessary Lexus will:

- Use the data for research on Lexus vehicle safety performance
- Disclose the data to a third party for research purposes without disclosing details of the vehicle owner, and only when it is deemed necessary
- Disclose summarized data cleared of vehicle identification information to a non-Lexus organization for research purposes

FarmaSOS.com



5-2. Steps to take in an emergency

If a warning light turns on or a warning buzzer sounds...

Calmly perform the following actions if any of the warning lights turn on or flash. If a light turns on or flashes, but then turns off, this does not necessarily indicate a malfunction in the system.

Stop the vehicle immediately. Continuing to drive the vehicle may be dangerous.

The following warning indicates a possible problem in the brake system. Immediately stop the vehicle in a safe place and contact your Lexus dealer.

Warning light	Warning light/Details
 (U.S.A.)	Brake system warning light (warning buzzer)*¹ <ul style="list-style-type: none">• Low brake fluid• Malfunction in the brake system This light also comes on when the parking brake is not released. If the light turns off after the parking brake is fully released, the system is operating normally.
 (Canada)	

*¹: Parking brake engaged warning buzzer:

→P.503

Stop the vehicle immediately.

The following warning indicates the possibility of damage to the vehicle that may lead to an accident. Immediately stop the vehicle in a safe place and contact your Lexus dealer.

Warning light	Warning light/Details
	Charging system warning light Malfunction in the vehicle's charging system.

Have the vehicle inspected immediately.

Failing to investigate the cause of the following warnings may lead to the system operating abnormally and possibly cause an accident. Have the vehicle inspected by your Lexus dealer immediately.

Warning light	Warning light/Details
 (U.S.A.)  (Canada)	Malfunction indicator lamp Malfunction in: <ul style="list-style-type: none"> • The electronic engine control system; • The electronic throttle control system; or • The automatic transmission control system.
	SRS warning light Malfunction in: <ul style="list-style-type: none"> • The SRS airbag system; • The front passenger occupant classification system; or • The seat belt pretensioner system.
 (U.S.A.)  (Canada)	ABS warning light Malfunction in: <ul style="list-style-type: none"> • The ABS; or • The brake assist system.
	ECB^{*2}/VSC warning light Malfunction in: <ul style="list-style-type: none"> • The electronically controlled brake system; or • The VSC.
	Electric power steering system warning light Malfunction in the EPS.
	"PCS" warning light (if equipped) Malfunction in the pre-collision system.

*2: Electronically Controlled Brake System

Have the malfunction repaired immediately.

After taking the specified steps to correct the suspected problem, check that the warning light turns off.

Warning light	Warning light/Details	Correction procedure
	Open door warning light (warning buzzer)*³ A door or the trunk is not fully closed.	Check that all doors and the trunk are closed.
	Low fuel level warning light Remaining fuel (Approximately 3.2 gal. [12 L, 2.6 Imp.gal.] or less)	Refuel the vehicle.
	Driver's seat belt reminder light (warning buzzer)*⁴ Warns the driver to fasten his/her seat belt.	Fasten the seat belt.
	Front passenger's seat belt reminder light (warning buzzer)*⁴ Warns the front passenger to fasten his/her seat belt.	Fasten the seat belt.
	Tire pressure warning light	
	When the light comes on: Low tire inflation pressure.	Adjust the tire inflation pressure.
	When the light comes on after blinking for 1 minute: Malfunction in the tire pressure warning system.	Have the system checked by your Lexus dealer.

Warning light	Warning light/Details	Correction procedure
	<p>Master warning light</p> <p>A buzzer sounds and the warning light comes on and flashes to indicate that the master warning system has detected a malfunction.</p>	<p>Take appropriate action in accordance with the message displayed on the multi-information display.</p>

*3: Open door warning buzzer:

→P. 502

*4: Driver's and front passenger's seat belt reminder buzzer:

The driver's and front passenger's seat belts reminder sounds to alert the driver and front passenger that his or her seat belt is not fastened. The buzzer sounds intermittently for 10 seconds after the vehicle has reached a speed of at least 12 mph (20 km/h). Then, if the seat belt is still unfastened, the buzzer will sound in a different tone for 20 more seconds.

تلفن شبانه روزی: ۰۲۱-۸۸۷۲۰۸۵

■ If the malfunction indicator lamp comes on while driving

First check the following:

- Is your vehicle low on gas?
If it is, refuel the vehicle immediately.
- Is the fuel tank cap loose?
If it is, tighten it securely.

The light will go off after taking several driving trips.

If the light does not go off even after several trips, contact your Lexus dealer as soon as possible.

■ Front passenger detection sensor and passenger seat belt reminder

- If luggage is placed on the front passenger seat, the front passenger detection sensor may cause the warning light to flash, even if a passenger is not sitting in the seat.
- If a cushion is placed on the seat, the sensor may not detect a passenger, and the warning light may not operate properly.

■ SRS warning light

This warning light system monitors the following:

- The airbag sensor assembly
- Front airbag sensors
- The curtain shield and rear side airbag sensors
- The side and curtain shield airbag sensors
- The front passenger occupant classification ECU
- "AIR BAG ON" and "AIR BAG OFF" indicator lights
- The pressure sensor
- The belt tension sensor
- The seat belt buckle switches
- The driver's seat position sensor
- The inflators
- The warning light
- The interconnecting wiring and power sources

■ If the tire pressure warning light comes on after blinking for 1 minute frequently

If the tire pressure warning light comes on after blinking for 1 minute frequently when the "ENGINE START STOP" switch is turned to IGNITION ON mode, have it checked by your Lexus dealer.

■ When the tire pressure warning light comes on

Check the tire inflation pressure and adjust to the appropriate level. Pushing the tire pressure warning reset switch does not turn off the tire pressure warning light.

■ If the tire pressure warning system is inoperative

The tire pressure warning system will be disabled in the following conditions:

(When the condition becomes normal, the system will work properly.)

- If tires not equipped with tire pressure warning valves and transmitters are used.
- If the ID code on the tire pressure warning valves and transmitters is not registered in the tire pressure warning computer.
- If the tire pressure warning select switch is set to a different tire setting.
- If the tire inflation pressure is 73 psi (500 kPa, 5.1 kgf/cm² or bar) or higher.

The tire pressure warning system may be disabled in the following conditions:

(When the condition becomes normal, the system will work properly.)

- If electronic devices or facilities using similar radio wave frequencies are nearby.
- If a radio set at similar frequencies is in use in the vehicle.
- If a window tint that affects the radio wave signals is installed.
- If there is a lot of snow or ice on the vehicle, in particular around the wheels or wheel housings.
- If non-genuine Lexus wheels are used. (Even if you use Lexus wheels, the tire pressure warning system may not work properly with some types of tires.)
- If tire chains are used.

■ The tire pressure warning light may turn on due to natural causes

The tire pressure warning light may turn on due to natural causes such as natural air leaks or tire inflation pressure changes caused by temperature. In this case, adjusting the tire inflation pressure will turn off the warning light (after a few minutes).

■ When a tire is replaced with a spare tire

The compact spare tire is not equipped with the tire pressure warning valve and transmitter. If a tire goes flat, the tire pressure warning light will not turn off even though the flat tire is replaced with the spare tire. Replace the spare tire with the repaired tire and adjust the proper tire inflation pressure. The tire pressure warning light will turn off after a few minutes.

 **CAUTION**

■ **If the tire pressure warning light comes on**

Be sure to observe the following precautions. Failure to do so could cause loss of vehicle control and result in death or serious injury.

● Vehicles with standard tires:

- Stop your vehicle in a safe place as soon as possible. Adjust the tire inflation pressure immediately.
- If the tire pressure warning light comes on even after tire inflation pressure adjustment, it is probable that you have a flat tire. Check the tires. If the tire is flat, change to the spare tire and have the flat tire repaired by the nearest Lexus dealer.
- Avoid abrupt maneuvering and braking. If the vehicle tires deteriorate, you could lose control of the steering wheel or the brakes.

● Vehicles with run-flat tires:

- Decelerate to the lowest appropriate speed as soon as possible. Do not drive over 55 mph (90 km/h).
- Check and adjust the tire inflation pressure immediately.
- If the tire pressure warning light comes on even after tire inflation pressure adjustment, it is probable that you have a flat tire. Have the tire replaced by the nearest Lexus dealer.
- Avoid abrupt maneuvering and braking. If the vehicle tires deteriorate, you could lose control of the steering wheel or the brakes.

■ **If a blowout or sudden air leakage should occur**

The tire pressure warning system may not activate immediately.

 **CAUTION**
■ Maintenance of the tires

Each tire, including the spare (if provided), should be checked monthly when cold and inflated to the inflation pressure recommended by the vehicle manufacturer on the vehicle placard or tire inflation pressure label (tire and load information label). (If your vehicle has tires of a different size than the size indicated on the vehicle placard or tire inflation pressure label [tire and load information label], you should determine the proper tire inflation pressure for those tires.)

As an added safety feature, your vehicle has been equipped with a tire pressure monitoring system (TPMS-tire pressure warning system) that illuminates a low tire pressure telltale (tire pressure warning light) when one or more of your tires is significantly under-inflated. Accordingly, when the low tire pressure telltale (tire pressure warning light) illuminates, you should stop and check your tires as soon as possible, and inflate them to the proper pressure. Driving on a significantly under-inflated tire causes the tire to overheat and can lead to tire failure. Under-inflation also reduces fuel efficiency and tire tread life, and may affect the vehicle's handling and stopping ability.

Please note that the TPMS (tire pressure warning system) is not a substitute for proper tire maintenance, and it is the driver's responsibility to maintain correct tire pressure, even if under-inflation has not reached the level to trigger illumination of the TPMS low tire pressure telltale (tire pressure warning light).

Your vehicle has also been equipped with a TPMS (tire pressure warning system) malfunction indicator to indicate when the system is not operating properly. The TPMS (tire pressure warning system) malfunction indicator is combined with the low tire pressure telltale (tire pressure warning light). When the system detects a malfunction, the telltale will flash for approximately one minute and then remain continuously illuminated. This sequence will continue upon subsequent vehicle start-ups as long as the malfunction exists. When the malfunction indicator is illuminated, the system may not be able to detect or signal low tire pressure as intended.

TPMS (tire pressure warning system) malfunctions may occur for a variety of reasons, including the installation of replacement or alternate tires or wheels on the vehicle that prevent the TPMS (tire pressure warning system) from functioning properly. Always check the TPMS (tire pressure warning system) malfunction telltale after replacing one or more tires or wheels on your vehicle to ensure that the replacement or alternate tires and wheels allow the TPMS (tire pressure warning system) to continue to function properly.

 NOTICE

■ **Precaution when installing a different tire**

When a tire of a different specification or maker is installed, the tire pressure warning system may not operate properly.

امداد خودرو فارما

تلفن شبانه روزی: ۰۲۱-۸۸۶۲۰۸۵

FarmaSOS.com

5-2. Steps to take in an emergency If a warning message is displayed

If a warning is shown on the multi-information display, stay calm and perform the following actions:



- 1 Multi-information display
- 2 Master warning light

The master warning light also comes on or flashes in order to indicate that a message is currently being displayed on the multi-information display.

If any of the warning light turns on again after performing the following actions, contact your Lexus dealer.





Stop the vehicle immediately.

A buzzer sounds and a warning message is shown on the multi-information display. The following warnings indicate the possibility of damage to the vehicle that may lead to an accident. Immediately stop the vehicle in a safe place and contact your Lexus dealer.



Warning message	Details
<p>LOW OIL PRESSURE</p>  (Flashing)	<p>Abnormal engine oil pressure.</p> <p>The warning light may turn on if the engine oil pressure is too low.</p>

Have the vehicle inspected immediately.

A buzzer sounds and a warning message is shown on the multi-information display. Failing to investigate the cause of the following warnings may lead to the system operating abnormally and possibly cause an accident. Have the vehicle inspected by your Lexus dealer immediately.









Warning message	Details
<p>CHECK HEADLIGHT</p> 	<p>Malfunction in the automatic headlight leveling system.</p>
<p>CHECK REARLAMP</p> 	<p>Malfunction in the rear lights system.</p>
<p>CHECK SYSTEM</p>  	<p>Malfunction in the tire pressure warning system. The tire pressure warning light comes on after blinking for 1 minute.</p>
<p>CHECK S/T LOCK</p>  (Flashing)	<p>Malfunction in the steering lock system.</p>

Warning message	Details
  (AWD models)	<p>Malfunction in the AWD system.</p>
  (If equipped)	<p>Intuitive parking assist malfunction. The malfunctioning sensor is shown flashing on the display.</p>
  (If equipped)	<p>Malfunction in the active stabilizer suspension system.</p>
   (If equipped)	<p>Malfunction in the PCS.</p>

Warning message	Details
<p>CHECK CRUISE SYSTEM</p> <p>CRUISE (Flashing)</p>  <p>(If equipped)</p>	<p>Malfunction in the radar cruise control system.</p> <p>Stop the vehicle in a safe place. Turn the "ENGINE START STOP" switch to OFF and then to IGNITION ON mode again to reset the cruise control system.</p>
<p>CHECK CHARGING SYSTEM</p> 	<p>Malfunction in the charging system.</p>
<p>CHECK POWER STEERING SYSTEM</p> 	<p>Malfunction in the power steering system.</p>
<p>BRAKE MALFUNCTION</p>	<p>Malfunction in the brake system.</p>
<p>CHECK ABS</p>	<p>Malfunction in the ABS.</p>

Have the vehicle inspected immediately.







Failing to investigate the cause of the following warning may lead to the system operating abnormally and possibly cause an accident. Have the vehicle inspected by your Lexus dealer immediately.

Warning message	Details
 	<p>Malfunction in the TRAC, VSC or hill-start assist control system. GS460: "CHECK ECB*" may be displayed at the same time, or on its own.</p>
   	<p>Malfunction in the ABS or brake assist system. GS460: "CHECK ECB*" may be displayed at the same time, or on its own.</p>
  (GS460)	<p>Malfunction in the VGRS.</p>
 (If equipped, steering guide symbol and arrows are flashing)	<p>The steering sensor cable is broken and signals cannot be received.</p>

*: Electronically Controlled Brake System





Have the malfunction repaired immediately.



A buzzer sounds and a warning message is shown on the multi-information display. After taking the specified steps to correct the suspected problem, check that the warning message turns off.





Warning message	Details	Correction procedure
<p>LEFT FRONT DOOR </p> <p>RIGHT FRONT DOOR </p> <p>LEFT REAR DOOR </p> <p>RIGHT REAR DOOR </p>	<p>One or more of the doors is not fully closed.</p> <p>The system also indicates which doors are not fully closed.</p> <p> flashes and a buzzer sounds to indicate that one or more of the doors is not fully closed (with the vehicle having reached a speed of 3 mph [5 km/h]).</p>	<p>Make sure that all of the doors are closed.</p>
<p>HOOD OPEN </p>	<p>The hood is not fully closed.</p> <p> flashes and a buzzer sounds to indicate that hood is not fully closed (with the vehicle having reached a speed of 3 mph [5 km/h]).</p>	<p>Close the hood.</p>

Warning message	Details	Correction procedure
	<p>The trunk is not fully closed.</p>  flashes and a buzzer sounds to indicate that trunk is not fully closed (with the vehicle having reached a speed of 3 mph [5 km/h]).	<p>Close the trunk.</p>
  (Flashing) (If equipped)	<p>The moon roof is not fully closed (with the “ENGINE START STOP” switch is OFF and the driver’s door opened).</p>	<p>Close the moon roof.</p>
  (Flashing)	<p>The parking brake is still engaged (with the vehicle having reached a speed of more than 3 mph [5 km/h]).</p>	<p>Release the parking brake.</p>
 	<p>The washer fluid level is low.</p>	<p>Add washer fluid.</p>

5-2. Steps to take in an emergency

Warning message	Details	Correction procedure
<p>LOW ENGINE OIL LEVEL</p> 	<p>The engine oil level is low.</p>	<p>Check the engine oil level, and add if necessary.</p>
<p>LOW TIRE</p>  	<p>Low tire inflation pressure.</p>	<p>Check the tire inflation pressure, and adjust to the appropriate level.</p>
<p>OIL MAINT REQD</p>  <p>(U.S.A. only)</p>	<p>The engine oil should be changed.</p> <p>Comes on approximately 5000 miles (8000 km) after the engine oil is changed (and the oil maintenance data has been reset).</p>	<p>Check and change the engine oil.</p>

Warning message	Details	Correction procedure
  (If equipped)	Intuitive parking assist is dirty or covered with ice.	Clean the sensor.
PCS NOT AVAILABLE NOW PCS (Flashing) (If equipped)	The PCS is not currently functional.	Clean the grille and the sensor. This message appears when the pre-collision system is hot. In this case, wait until the system cools down.
CLEAN RADAR SENSOR CRUISE (Flashing)  (If equipped)	The radar cruise control sensor is dirty or covered with ice.	Clean the sensor.

Warning message	Details	Correction procedure
   (If equipped)	<p>The radar cruise control system is unable to judge vehicle-to-vehicle distance.</p>	<ul style="list-style-type: none"> • Turn the mode select switch to either the normal or power mode. • If the windshield wipers are on, turn them off or set them to either the intermittent or the slow mode.
 (If equipped, flashing)	<p>Your vehicle is nearing the vehicle ahead (in radar cruise mode).</p>	<p>Slow the vehicle by applying the brakes.</p>

■ After changing the engine oil (U.S.A. only)

Make sure to reset the oil maintenance data. (→P. 412) تلفن شب ۰۲۱۱۱۱۱۱۱۱

■ Approach warning message

In the following instances, there is the possibility that the approach warning will not activate even when the vehicle-to-vehicle distance decreases.

- When your vehicle and the vehicle ahead are traveling at the same speed or the vehicle ahead is traveling more quickly than your vehicle.
- When the vehicle ahead is traveling at very low speed.
- Immediately after cruise control speed is set.
- At the instant the accelerator pedal is depressed.

Other messages

If the following message is displayed, take appropriate action and confirm that the message has disappeared.

Message	Details
 <p>(If equipped)</p>	<p>Calibrate the neutral position of the steering wheel.</p>

■ Initializing the steering sensor





Use one of the following methods.



- With the vehicle stopped, turn the steering wheel all the way to the left and right. (The order is not important.)
- Drive for more than 5 minute on an un-crowded road with as few curves and corners as possible.

If the steering guide symbol disappears, the steering sensor has been initialized. If the steering guide symbol does not disappear, have the vehicle checked by your Lexus dealer.

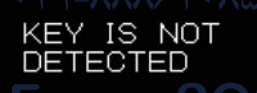



Have the malfunction repaired immediately.

After taking the specified steps to correct the suspected problem, check that the warning message and light turn off.

Interior buzzer	Exterior buzzer	Warning message	Details	Correction procedure
Once	—	 (Comes on for 10 seconds.)  (Flashing)	The electronic key is not detected when attempting to start the engine.	Confirm the location of the electronic key.
Once	3 times	  (Flashing)	An open door other than the driver's door is closed while the electronic key is outside the detection range and the "ENGINE START STOP" switch is in ACCESSORY or IGNITION ON mode.	Confirm the location of the electronic key.

Interior buzzer	Exterior buzzer	Warning message	Details	Correction procedure
Once	3 times	 <p>KEY IS NOT DETECTED (Flashing)</p>	An open door other than the driver's door is closed while the electronic key is outside the detection range and the "ENGINE START STOP" switch is in ACCESSORY or IGNITION ON mode with the shift lever in "P".	Turn the "ENGINE START STOP" switch to OFF or confirm the location of the electronic key.
Continuous	Continuous	 <p>SHIFT TO P RANGE KEY IS NOT DETECTED (Displayed alternately) (Flashing)</p>	An open door other than the driver's door is closed while the electronic key is outside the detection range and the "ENGINE START STOP" switch is in ACCESSORY or IGNITION ON mode with the shift lever not in "P".	<ul style="list-style-type: none"> • Shift the shift lever to "P". • Confirm the location of the electronic key.

5-2. Steps to take in an emergency

Interior buzzer	Exterior buzzer	Warning message	Details	Correction procedure
Once	—	  (Flashing)	The electronic key battery is low.	Replace the battery. (→P. 440)
—	—		An open door has been closed and the “ENGINE START STOP” switch has been turned twice to the ACCESSORY mode from OFF.	Press the “ENGINE START STOP” switch while applying the brakes.
—	—	  (Flashing)	The steering lock has not released within 3 seconds of pressing the “ENGINE START STOP” switch. The “ENGINE START STOP” switch indicator will flash green for 15 seconds.	Press the “ENGINE START STOP” switch again while turning the steering wheel with the brake pedal depressed.

Interior buzzer	Exterior buzzer	Warning message	Details	Correction procedure
Once	—	DEPRESS THE BRAKE PEDAL, AND TOUCH THE ENGINE SWITCH WITH THE KEY	The electronic key does not operate properly.	→P. 526
—	—	TO START, DEPRESS THE BRAKE PEDAL, AND PUSH THE ENGINE SWITCH		

امداد خودرو فارما

تلفن شبانه روزی: ۰۲۱-۸۸۸۶۲۰۸۵

FarmaSOS.com

5-2. Steps to take in an emergency

If you have a flat tire (Vehicles with standard tires)

Remove the flat tire and replace it with the spare provided.

■ Before jacking up the vehicle

- Stop the vehicle on a hard, flat surface.
- Set the parking brake.
- Shift the shift lever to "P".
- Stop the engine.
- Turn on the emergency flashers.

■ Location of the spare tire, jack and tools

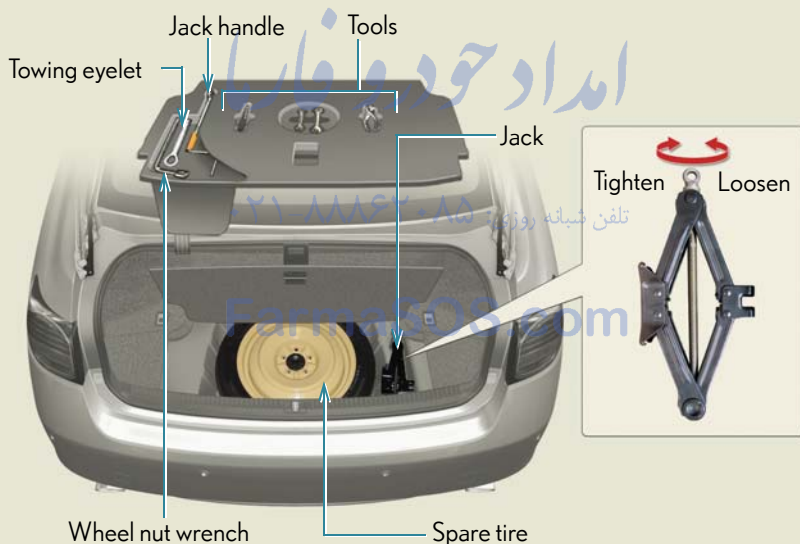

■ Compact spare tire

The compact tire saves space in your luggage compartment, and its lighter weight helps to enhance fuel economy and permits easier installation in case of a flat tire.



The compact spare tire is designed for temporary emergency use only.

■ The compact spare tire

- The compact spare tire is identified by the label "TEMPORARY USE ONLY" on the tire sidewall.
Use the compact spare tire temporarily only in an emergency.
- Make sure to check the tire inflation pressure of the compact spare tire. (→P. 550)

■ Tread life

The compact spare tire can be used many times, if necessary. It has tread life of up to 3000 miles (4800 km) depending on road conditions and your driving habits. When treadwear indicators appear on the tire, replace the tire. (→P. 421)

■ When using the compact spare tire

As the spare tire is not equipped with the tire pressure warning valve and transmitter, low inflation pressure of the spare tire will not be warned. Also, if you replace the compact spare tire after the tire pressure warning light comes on, the light remains on.

Taking out the spare tire

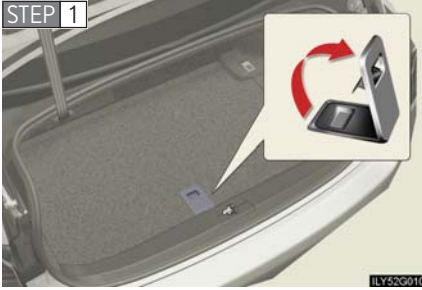

Lift up the hook of the panel on the trunk floor.

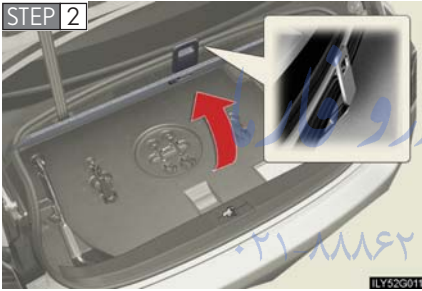

Secure the panel using the hook provided. Then take out the tool tray.

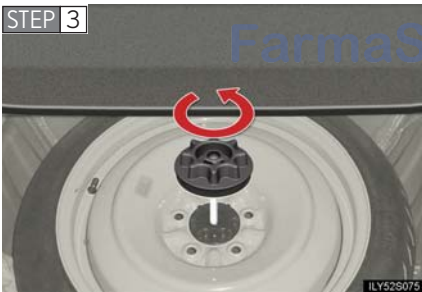

Loosen the center fastener that secures the spare tire.

If the center fastener cannot be turned by hand, use the wrench that is stored in the trunk. (To secure the tire, tighten the center fastener by hand. Do not use the wrench or other tools.)

Replacing a flat tire

STEP 1



Chock the tires.

Flat tire		Wheel chock positions
Front	Left-hand side	Behind the rear right-hand side tire
	Right-hand side	Behind the rear left-hand side tire
Rear	Left-hand side	In front of the front right-hand side tire
	Right-hand side	In front of the front left-hand side tire

STEP 2



Slightly loosen the wheel nuts (one turn).

5-2. Steps to take in an emergency

STEP 3

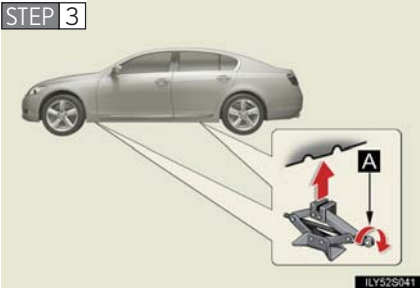

Turn the tire jack portion "A" by hand until the notch of the jack is in contact with the jack point.

STEP 4



Raise the vehicle until the tire is slightly raised off the ground.

STEP 5



Remove all the wheel nuts and the tire.

When resting the tire on the ground, place the tire so that the wheel design faces up to avoid scratching the wheel surface.

Installing the spare tire

STEP 1

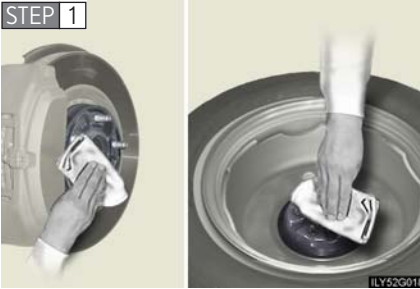

Remove any dirt or foreign matter from the wheel contact surface.

If foreign matter is on the wheel contact surface, the wheel nuts may loosen while the vehicle is in motion, and the tire may come off the vehicle.

STEP 2

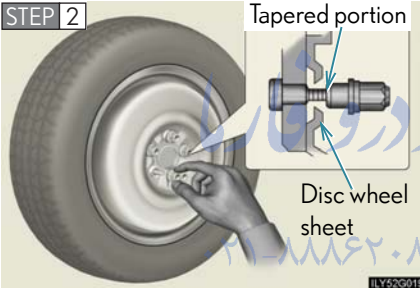

Install the spare tire and loosely tighten each wheel nut by hand to approximately the same amount.

Tighten the wheel nuts until the tapered portion comes into loose contact with the disc wheel sheet.

STEP 3



Lower the vehicle.

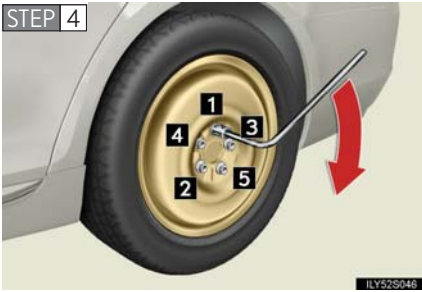

Firmly tighten each nut two or three times in the order shown in the illustration.

Tightening torque:
76 ft•lbf (103 N•m, 10.5 kgf•m)

STEP 5 Stow the flat tire, tire jack and all tools.

■ **If you have a flat rear tire on a road covered with snow or ice**

Install the compact spare tire on the front of the vehicle. Perform the following steps and fit tire chains to the rear tires.

STEP 1 Replace a front tire with the compact spare tire.

STEP 2 Replace the flat rear tire with the tire removed from the front of the vehicle.

STEP 3 Fit tire chains to the rear tires.

■ **After completing the tire change**

The tire pressure warning system must be reset. (→P. 422)

FarmaSOS.com

 **CAUTION**
■ Using the tire jack

Improper use of the tire jack may lead to death or injuries due to the vehicle suddenly falling off the jack.

- Do not use the tire jack for any purpose other than replacing tires or installing and removing tire chains.
- Only use the tire jack that comes with this vehicle for replacing a flat tire. Do not use it on other vehicles, and do not use other tire jacks for replacing tires on this vehicle.
- Always check that the tire jack is securely set to the jack point.
- Do not raise the vehicle while someone is in it.
- When raising the vehicle, do not put an object on or under the jack.
- Do not raise the vehicle to a height greater than that required to replace the tire.
- Use a jack stand if it is necessary to get under the vehicle.
- Do not put any part of your body under the vehicle supported by a jack.
- Do not start or run the engine while your vehicle is supported by the jack.

Take particular care when lowering the vehicle to ensure that no one working on or near the vehicle may be injured.

■ Replacing a flat tire

Observe the following precautions to reduce the risk of death or serious injury.

- Never use oil or grease on the wheel bolts or wheel nuts. The oil or grease can cause the wheel nuts to loosen, causing a serious accident. Remove any oil or grease on the wheel bolts or wheel nuts.
- Have the wheel nuts tightened with a torque wrench to 76 ft•lbf (103 N•m, 10.5 kgf•m) as soon as possible after changing wheels. Failure to follow these precautions could cause the nuts to loosen and the wheels may fall off, which could lead to an accident causing death or serious injury.

 CAUTION

■ **When using the compact spare tire**

- Remember that your spare tire is specifically designed for use with your vehicle. Do not use your spare tire on another vehicle.
- Do not use two spare tires simultaneously.
- Replace the spare tire with a standard tire as soon as possible.
- Avoid sudden acceleration, deceleration and braking, as well as sharp cornering.

■ **Speed limit when using the compact spare tire**

Do not drive at speeds in excess of 50 mph (80 km/h) when a compact spare tire is installed on the vehicle.

The compact spare tire is not designed for driving at high speeds. Failing to observe this precaution may lead to an accident causing death or serious injury.

تلفن شبانه روزی: ۰۲۱-۸۸۶۲۰۸۵

FarmaSOS.com

 NOTICE

■ **Do not drive the vehicle with a flat tire**

Do not continue driving with a flat tire.

Driving even a short distance with a flat tire can damage the tire and the wheel beyond repair.

■ **Be careful when driving over bumps with the compact spare tire installed on the vehicle**

The vehicle becomes lower when driving with the compact spare tire compared to when driving with standard tires. Be careful when driving over uneven road surfaces.

■ **Driving with tire chains and the compact spare tire**

Do not fit tire chains to the compact spare tire.

Tire chains may damage the vehicle body and adversely affect driving performance.

■ **When replacing the tires**

When removing or fitting the wheels, tires or the tire pressure warning valve and transmitter, contact your Lexus dealer as the tire pressure warning valve and transmitter may be damaged if not handled correctly.

■ **To avoid damaging the tire pressure warning valves and transmitters**

Do not use liquid sealants on flat tires.

5-2. Steps to take in an emergency

If you have a flat tire (Vehicles with run-flat tires)

Take your vehicle to the nearest Lexus dealer or authorized tire dealer as soon as possible.

- Run-flat tires (A “RFT” or “DSST” mark is molded on the sidewall)



You can continue driving a vehicle with run-flat tires even if any tire goes flat.

It is able to run for a maximum of 100 miles (160 km) at a speed below 55 mph (90 km/h) after the tire pressure warning light comes on. (→P. 490)

- In some condition (such as at high temperatures)

You can not continue driving for up to 100 miles (160 km).

- If you cannot distinguish between the standard tires and run-flat tires

Consult your Lexus dealer.

- For the detailed information on run-flat tires

See the tire warranty book.

NOTICE

- When replacing the tires

Have the tires replaced by the nearest Lexus dealer or authorized tire dealer. The tire pressure warning valves and transmitters will be affected by the installation or removal of tires.

- To avoid damaging the tire pressure warning valves and transmitters

Do not use liquid sealants on flat tires.

5-2. Steps to take in an emergency If the engine will not start

If the engine will not start even though correct starting procedures are being followed (→P. 121), consider each of the following points.

■ The engine will not start even if you are carrying the correct electronic key

One of the following may be the cause of the problem.

- There may not be sufficient fuel in the vehicle's tank.

Add fuel to the vehicle.

- The engine may be flooded.

Try to restart the engine once more following correct starting procedures. (→P. 121)

- There may be a malfunction in the immobilizer system. (→P. 73)

■ The starter motor turns over slowly, the interior lights and headlights are dim, or the horn does not sound or sounds at a low volume

One of the following may be the cause of the problem.

- The 12 volt battery may be discharged. (→P. 529)

- The 12 volt battery terminal connections may be loose or corroded.

■ The starter motor does not turn over, the interior lights and headlights do not turn on, or the horn does not sound

One of the following may be the cause of the problem.

- One or both of the 12 volt battery terminals may be disconnected.

- The 12 volt battery may be discharged. (→P. 529)

Contact your Lexus dealer if the problem cannot be repaired, or if repair procedures are unknown.

5-2. Steps to take in an emergency

If the shift lever cannot be shifted from “P”

If the shift lever cannot be shifted with your foot on the brake, there may be a problem with the shift lock system (a system to prevent accidental operation of the shift lever). Have the vehicle inspected by your Lexus dealer immediately.

The following steps may be used as an emergency measure to ensure that the shift lever can be shifted.

STEP 1 Set the parking brake.

STEP 2 Turn the “ENGINE START STOP” switch to the ACCESSORY mode.

STEP 3 Depress the brake pedal.

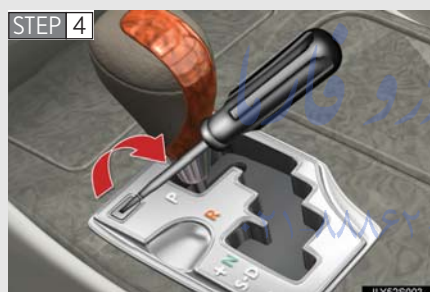

Pry the cover up with a flathead screwdriver or equivalent.



Press the shift lock override button.

The shift lever can be shifted while the button is pressed.

5-2. Steps to take in an emergency If you lose your keys

New genuine Lexus keys can be made by your Lexus dealer using one of the other keys and the key number stamped on your key number plate.

امداد خودرو فارما

تلفن شبانه روزی: ۰۲۱-۸۸۸۶۲۰۸۵

FarmaSOS.com

5-2. Steps to take in an emergency

If the electronic key does not operate properly

If communication between the electronic key and vehicle is interrupted (→P. 26) or the electronic key cannot be used because the battery is depleted, the smart access system with push-button start and wireless remote control cannot be used. In such cases, the doors and trunk can be opened or the engine can be started by following the procedure below.

Locking and unlocking the doors, unlocking the trunk and key linked functions

► Doors

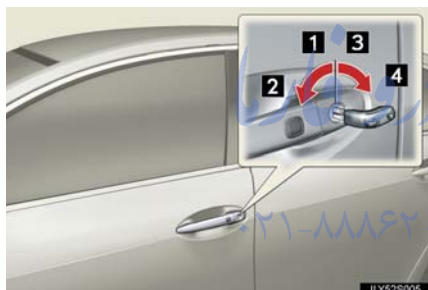

Using the mechanical key in order to perform the following operations:

- 1 Locks all doors
- 2 Closes the windows/moon roof (turn and hold)
- 3 Unlocks the door

Turning the key rearward unlocks the driver's door.

Turning the key once again unlocks the other doors.

- 4 Opens the windows/moon roof (turn and hold)

► Trunk



Turn the mechanical key clockwise to open.

Changing “ENGINE START STOP” switch modes and starting the engine

STEP 1 Put the shift lever in “P” and apply the brakes.



Touch the Lexus emblem side of the electronic key to the “ENGINE START STOP” switch.

An alarm will sound to indicate that the start function cannot detect the electronic key that is touched to the “ENGINE START STOP” switch if any of the doors is opened and closed while the key is touched to the switch.

STEP 3 To change the “ENGINE START STOP” switch modes: Within 10 seconds of the buzzer sounding, release the brake pedal and press the “ENGINE START STOP” switch. Modes can be changed each time the switch is pressed. (→P. 122)

To start the engine: Press the “ENGINE START STOP” switch within 10 seconds after the buzzer sounds, keeping the brake pedal depressed.

If the “ENGINE START STOP” switch still cannot be operated, contact your Lexus dealer.

■ **Stopping the engine**

Shift the shift lever to “P” and press the “ENGINE START STOP” switch as you normally do when stopping the engine.

■ **Replacing the key battery**

As the above procedure is the temporary measure, it is recommended that the electronic key battery be replaced immediately when the battery depletes. (→P. 440)

تلفن شبانه روزی: ۰۲۱-۸۸۶۲۰۸۵

FarmaSOS.com

5-2. Steps to take in an emergency If the 12 volt battery is discharged

The following procedures may be used to start the engine if the 12 volt battery is discharged.

You can call your Lexus dealer or qualified repair shop.

If you have a set of jumper (or booster) cables and a second vehicle with a 12 volt battery, you can jump start your Lexus following the steps below.

STEP 1 Open the door using the mechanical key, then open the hood.
GS350: Remove the engine compartment covers.

STEP 2 Connecting the jumper cables.

► GS460

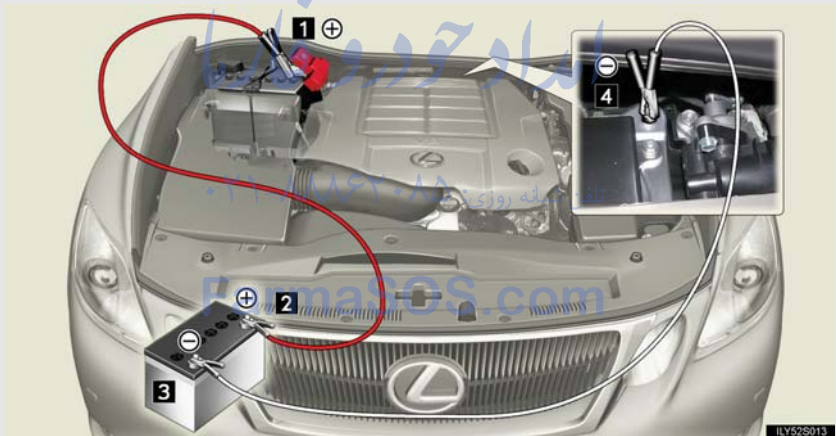

► GS350

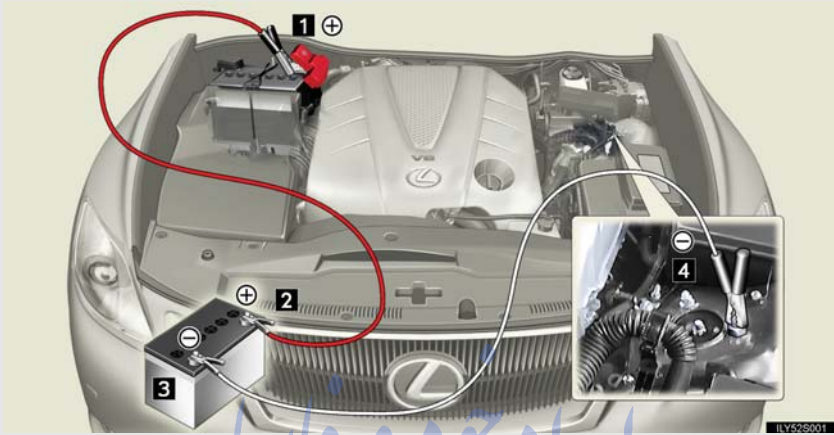

- 1 Positive (+) battery terminal on your vehicle.
 - 2 Positive (+) battery terminal on the second vehicle.
 - 3 Negative (-) battery terminal on the second vehicle.
 - 4 Connect the jumper cable to ground on your vehicle as shown.
- STEP 3** Start the engine of the second vehicle. Increase the engine speed slightly and maintain at that level for approximately 5 minutes to recharge the 12 volt battery of your vehicle.
- STEP 4** Open and close any of the doors with the “ENGINE START STOP” switch is OFF.

STEP 5 Maintain the engine speed on the second vehicle and turn the “ENGINE START STOP” switch to the IGNITION ON mode, then start the vehicle’s engine.

STEP 6 Once the vehicle’s engine has started, remove the jumper cables in the exact reverse order in which they were connected.

Once the engine starts, have the vehicle checked at your Lexus dealer as soon as possible.

■ Starting the engine when the 12 volt battery is discharged

The engine cannot be started by push-starting.

■ To prevent 12 volt battery discharge

- Turn off the headlights and the audio system while the engine is turned off.
- Turn off any unnecessary electrical components when the vehicle is running at a low speed for an extended period, such as in heavy traffic, etc.

■ When the 12 volt battery is removed or discharged

The following systems must be initialized.

- Tire pressure warning system (→P. 422)
- Intuitive parking assist (→P. 507)

CAUTION

■ Avoiding battery fires or explosions

Observe the following precautions to prevent accidentally igniting the flammable gas that may be emitted from the battery.

- Make sure the jumper cable is connected to the correct terminal and that it is not unintentionally in contact with any part other than the intended terminal.
- Do not allow the jumper cables to come into contact with the “+” and “-” terminals.
- Do not allow open flame or use matches, cigarette lighters or smoke near the battery.

 CAUTION

■ **Battery precautions**

The battery contains poisonous and corrosive acidic electrolyte, while related parts contain lead and lead compounds. Observe the following precautions when handling the battery:

- When working with the battery, always wear safety glasses and take care not to allow any battery fluids (acid) to come into contact with skin, clothing or the vehicle body.
- Do not lean over the battery.
- If the battery fluid comes into contact with the skin or eyes, immediately wash the affected area with water and seek medical attention.
Place a wet sponge or cloth over the affected area until medical attention can be received.
- Always wash your hands after handling the battery support, terminals, and other battery-related parts.
- Do not allow children near the battery.

تلفن شبانه روزی: ۰۲۱-۸۸۶۲۰۸۵

 NOTICE

■ **When handling jumper cables**

Be careful that the jumper cables do not become tangled in the cooling fan or any of the belts when connecting or disconnecting them.

FarmaSOS.com

5-2. Steps to take in an emergency If your vehicle overheats

If your engine overheats:

STEP 1 Stop the vehicle in a safe place and turn off the air conditioning system.

STEP 2 Check to see if steam is coming out from under the hood.

If you see steam:

Stop the engine and carefully lift the hood.

If you do not see steam:

Leave the engine running and carefully lift the hood.

STEP 3 Remove the engine compartment cover. (→P. 408)

STEP 4 Check to see if the cooling fan is operating.

If the fan is operating:

Wait until the engine coolant temperature gauge begins to fall and then stop the engine.

If the fan is not operating:

Stop the engine immediately and call your local Lexus dealer. تلفن شبانه روزی: ۰۲۱-۸۸۶۲۰۸۵

STEP 5



After the engine has cooled down sufficiently, check the coolant level and inspect the radiator core (radiator) for any leaks.

STEP 6



Add coolant if necessary.

Water can be used in an emergency measure if coolant is unavailable. (→P. 546)

Have the vehicle checked at your nearest Lexus dealer as soon as possible.

■ Overheating

In the following situations, your vehicle may be overheating.

- The engine coolant temperature gauge enters the red zone or a loss of power is experienced.
- Steam is coming from under the hood.

امداد خودرو فارما
تلفن شبانه روزی: ۰۲۱-۸۸۶۲۰۸۵

⚠ CAUTION

FarmaSOS.com

■ To prevent an accident or injury when inspecting under the hood of your vehicle

- Keep hands and clothing away from the fan and engine drive belt while the engine is running.
- Do not loosen the radiator cap while the engine and radiator are hot. Serious injury, such as burns, may result from hot coolant and steam released under pressure.

 NOTICE**■ When adding coolant**

Wait until the engine has cooled down before adding coolant.

When adding coolant, do so slowly. Adding cool coolant to a hot engine too quickly can cause damage to the engine.

امداد خودرو فارما

تلفن شبانه روزی: ۰۲۱-۸۸۶۲۰۸۵

FarmaSOS.com

5-2. Steps to take in an emergency If the vehicle becomes stuck

Carry out the following procedures if the tires spin or the vehicle becomes stuck in mud, dirt, or snow.

STEP 1 Stop the engine. Set the parking brake and shift the shift lever in "P".

STEP 2 Remove the mud, snow, or sand from around the stuck tire.

STEP 3 Place wood, stones or some other material to help provide traction under the tires.

STEP 4 Restart the engine.

STEP 5 Shift the shift lever to the "D" or "R" position and carefully apply the accelerator to free the vehicle.

Turn off TRAC/VSC if these functions are hampering your attempts to free the vehicle. (→P.186)

CAUTION

■ When attempting to free a stuck vehicle

If you choose to rock the vehicle back and forth to free it, make sure the surrounding area is clear, to avoid striking other vehicles, objects or persons. The vehicle may also lunge forward or lunge back suddenly as it becomes free. Use extreme caution.

■ When shifting the shift lever

Be careful not to shift the shift lever with the accelerator pedal depressed. This may lead to unexpected rapid acceleration of the vehicle that may cause an accident and result in death or serious injury.

 NOTICE**■ To avoid damaging the automatic transmission and other components**

- Avoid spinning the wheels and racing the engine.
- If the vehicle remains stuck after trying these procedures, the vehicle may require towing to be freed.

امداد خودرو فارما

تلفن شبانه روزی: ۰۲۱-۸۸۶۲۰۸۵

FarmaSOS.com

امداد خودرو فارما

تلفن شبانه روزی: ۰۲۱-۸۸۸۶۲۰۸۵

FarmaSOS.com

6-1. Specifications..... 540
Maintenance data
(fuel, oil level, etc.) 540
Fuel information..... 553
Tire information..... 556

6-2. Customization..... 569
Customizable features 569

6-3. Initialization 575
Items to initialize 575

ایجاد خودرو فارما

تلفن: ۰۲۱-۸۸۶۲۰۸۵

FarmaSOS.com

6-1. Specifications

Maintenance data (fuel, oil level, etc.)

Dimensions and weight

Overall length		190.7 in. (4845 mm)
Overall width		71.6 in. (1820 mm)
Overall height *	2WD	56.1 in. (1425 mm)
	4WD	56.4 in. (1435 mm)
Wheelbase		112.2 in. (2850 mm)
Tread	Front	60.4 in. (1535 mm)
	Rear	
	2WD	60.6 in. (1540 mm)
4WD	60.4 in. (1535 mm)	
Vehicle capacity weight (Occupants + luggage)		815 lb. (370 kg)

*: Unladen vehicle

تلفن شبانه روزی: +۲۱-۸۸۶۲۰۸۵

FarmaSOS.com

Vehicle identification

The vehicle identification number (VIN) is the legal identifier for your vehicle. This is the primary identification number for your Lexus. It is used in registering the ownership of your vehicle.

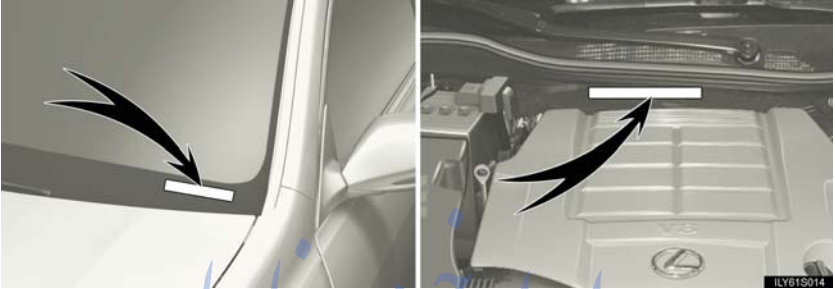

This number is stamped on the top left of the instrument panel and in the engine compartment.



This number is also on the Certification Label.

■ Engine number

▶ GS460

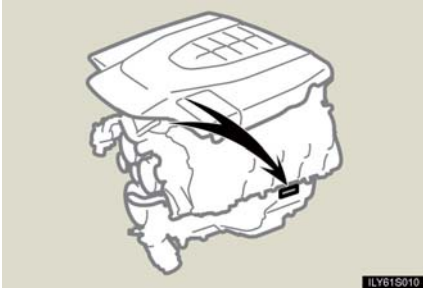

▶ GS350



امداد خودرو خارا

تلفن شبانه روزی: ۰۸۵-۸۸۶۲۰۲۱

The engine number is stamped on the location as shown.

Farma303.com

Engine

	GS460	GS350
Model	1UR-FSE	2GR-FSE
Type	8-cylinder V type, 4-cycle, gasoline	6-cylinder V type, 4-cycle, gasoline
Bore and stroke	3.70 × 3.27 in. (94.0 × 83.0 mm)	
Displacement	281.2 cu.in. (4608 cm ³)	210.9 cu.in. (3456 cm ³)
Drive belt tension	Automatic adjustment	

Fuel

Fuel type	Premium unleaded gasoline only
Octane Rating	91 (Research Octane Number 96) or higher
Fuel tank capacity	18.7 gal. (71 L, 15.6 Imp.gal.)

FarmaSOS.com

Lubrication system

► GS460

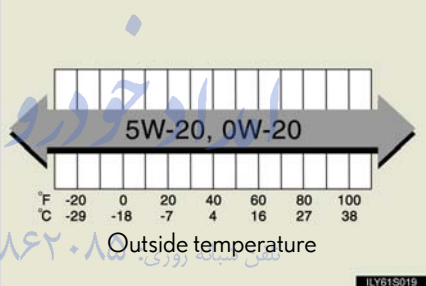
Oil capacity (drain and refill)	With filter: 9.1 qt. (8.6 L, 7.6 Imp.qt.) Without filter: 8.9 qt. (8.4 L, 7.4 Imp.qt.)
Oil grade	ILSAC multi-grade engine oil
Recommended oil viscosity	Use Lexus approved "Toyota Genuine Motor Oil" or equivalent to satisfy the grade and viscosity shown below. 

Oil viscosity:

- The 0W portion of the oil viscosity rating indicates the characteristic of the oil which allows cold startability. Oils with a lower value before the W allow for easier starting of the engine in cold weather.
- The 20 in 0W-20 indicates the oil viscosity when the oil is at its operating temperature. An oil with a higher viscosity may be better suited if the vehicle is operated at high speeds, or under extreme load condition.

► GS350

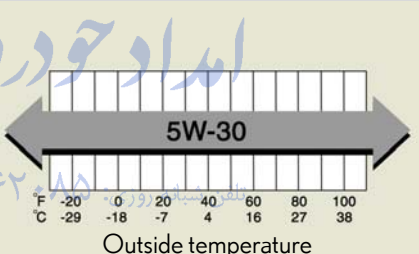
	2WD	4WD
Oil capacity (drain and refill)		
with filter	6.6 qt. (6.3 L, 5.5 Imp.qt.)	6.7 qt. (6.4 L, 5.6 Imp.qt.)
without filter	6.2 qt. (5.9 L, 5.2 Imp.qt.)	6.3 qt. (6.0 L, 5.3 Imp.qt.)
Oil grade	ILSAC multigrade engine oil	
Recommended oil viscosity	<p>Use Lexus approved "Toyota Genuine Motor Oil" or equivalent to satisfy the grade and viscosity shown below.</p>  <p style="text-align: center;">Outside temperature</p> <p style="text-align: right; font-size: small;">ILY61S016</p>	

Oil viscosity:

- The 5W portion of the oil viscosity rating indicates the characteristic of the oil which allows cold startability. Oils with a lower value before the W allow for easier starting of the engine in cold weather.
- The 30 in 5W-30 indicates the oil viscosity when the oil is at its operating temperature. An oil with a higher viscosity may be better suited if the vehicle is operated at high speeds, or under extreme load condition.

Cooling system

Capacity	GS460	11.7 qt. (11.0 L, 9.7 Imp.qt.)
	GS350	9.6 qt. (9.1 L, 8.0 Imp.qt.)
Coolant type	Use either of the following: <ul style="list-style-type: none"> • “Toyota Super Long Life Coolant” • Similar high-quality ethylene glycol-based non-silicate, non-amine, non-nitrite, and non-borate coolant with long-life hybrid organic acid technology Do not use plain water alone.	

Ignition system

Spark plug		
Make	DENSO	FK20HBR11
Gap	0.043 in. (1.1 mm) <small>تلفن شبانه روزی: ۰۲۱-۱۱۱۶۷۰۸۸</small>	

NOTICE

FarmaSOS.com

■ Iridium-tipped spark plugs

Use only iridium-tipped spark plugs. Do not adjust gap when tuning engine.

Electrical system

12 volt battery	
Open voltage at 68°F (20°C):	12.6 — 12.8V Fully charged 12.2 — 12.4V Half charged 11.8 — 12.0V Discharged (Voltage is checked 20 minutes after the engine and all lights are turned off.)
Charging rates	5A max.

Differential

	GS460/ GS350 (2WD)	GS350 (4WD)	
		Front	Rear
Oil capacity	1.42 qt. (1.35 L, 1.19 Imp.qt.)	0.73 qt. (0.70 L, 0.61 Imp.qt.)	1.42 qt. (1.35 L, 1.19 Imp.qt.)
Oil type and viscosity	Toyota Genuine Differential Gear Oil LT 75W-85 GL-5 or equivalent	Hypoid gear oil API GL-5 Above 0°F (-18°C): SAE 90 Below 0°F (-18°C): SAE 80W or SAE 80W-90	Toyota Genuine Differential Gear Oil LT 75W-85 GL-5 or equivalent

Rear differential: “Toyota Genuine Differential Gear Oil” is filled in your Lexus vehicle at factory fill. Use Lexus approved “Toyota Genuine Differential Gear Oil” or an equivalent of matching quality to satisfy the above specification. Please contact your Lexus dealer for further details.

Automatic transmission

Fluid capacity *	GS460	11.1 qt. (10.5 L, 9.2 Imp.qt.)
	GS350 (2WD)	8.4 qt. (7.9 L, 7.0 Imp.qt.)
	GS350 (4WD)	10.6 qt. (10.0 L, 8.8 Imp.qt.)
Fluid type		Toyota Genuine ATF WS

*: The fluid capacity is the quantity of reference. If replacement is necessary, contact your Lexus dealer.

 NOTICE

■ Automatic transmission fluid type

Using automatic transmission fluid other than "Toyota Genuine ATF WS" may cause deterioration in shift quality, locking up of your automatic transmission accompanied by vibration, and ultimately damage the automatic transmission of your vehicle.

تلفن شبانه روزی: ۰۲۱-۸۸۶۲۰۸۵

FarmaSOS.com

Brakes

Pedal clearance	GS460 * ¹	2.9 in. (74 mm) Min.
	GS350 * ²	2.6 in. (65 mm) Min.
Pedal free play	GS460	Less than 0.08 in. (2.0 mm)
	GS350	0.04—0.08 in. (1.0—2.0 mm)
Brake pad wear limit		0.04 in. (1.0 mm)
Parking brake pedal travel * ³		7—9 clicks
Parking brake lining wear limit		0.04 in. (1.0 mm)
Fluid type		SAE J1703 or FMVSS No. 116 DOT 3

*¹: Minimum pedal clearance when depressed with a force of 200 N (20.4 kgf, 45 lbf) while the engine is running.

*²: Minimum pedal clearance when depressed with a force of 500 N (51.0 kgf, 112 lbf) while the engine is running.

*³: Parking brake pedal travel when depressed with a force of 300 N (30.6 kgf, 67.4 lbf).

Steering

Free play	Less than 1.2 in. (30 mm)
-----------	---------------------------

Tires and wheels

► Type A

Tire size	245/40R18 93Y, P245/40R18 93V, 245/40ZR18, T155/70D17 110M (spare)
Front and rear tire inflation pressure (Recommended cold tire inflation pressure)	Driving under normal conditions 33 psi (230 kPa, 2.3 kgf/cm ² or bar) Driving at high speeds above 100 mph (160 km/h) (in countries where such speeds are permitted by law) Add 9 psi (60 kPa, 0.6 kgf/cm ² or bar) to the front tires and rear tires. Never exceed the maximum cold tire inflation pressure indicated on the tire sidewall.
Spare tire inflation pressure (Recommended cold tire inflation pressure)	60 psi (420 kPa, 4.2 kgf/cm ² or bar)
Wheel size	18 × 8 J, 17 × 4T (spare)
Wheel nut torque	76 ft•lbf (103 N•m, 10.5 kgf•m)

► Type B

Tire size	225/50R17 94W, P225/50R17 93V, T155/70D17 110M (spare)
Front and rear tire inflation pressure (Recommended cold tire inflation pressure)	Driving under normal conditions 33 psi (230 kPa, 2.3 kgf/cm ² or bar) Driving at high speeds above 100 mph (160 km/h) (in countries where such speeds are permitted by law) Add 7 psi (50 kPa, 0.5 kgf/cm ² or bar) to the front tires and rear tires. Never exceed the maximum cold tire inflation pressure indicated on the tire sidewall.
Spare tire inflation pressure (Recommended cold tire inflation pressure)	60 psi (420 kPa, 4.2 kgf/cm ² or bar)
Wheel size	17 × 7 1/2 J, 17 × 4T (spare)
Wheel nut torque	76 ft•lbf (103 N•m, 10.5 kgf•m)

FarmaSOS.com

Light bulbs

	Light bulbs	Bulb No.	W	Type
Exterior	Headlights (low beam)	D4S	35	A
	Headlights (high beam)	HB3	60	B
	Front turn signal lights	—	21	C
	Parking lights	—	5	D
	Fog lights	HB4	51	E
	Front side marker light	194	5	D
	Rear turn signal lights	—	21	C
	Back-up lights	921	16	D
	Trunk light	—	5	F
Interior	Vanity lights	—	8	D

A: D4S high-intensity discharge bulbs

B: HB3 halogen bulbs

C: Wedge base bulbs (amber)

D: Wedge base bulbs (clear)

E: HB4 halogen bulbs

F: Double end bulbs

Fuel information

Your vehicle must use only unleaded gasoline.

Premium unleaded gasoline with an Octane Rating 91 (Research Octane Number 96) or higher required for optimum engine performance.

At minimum, the gasoline you use should meet the specifications of ASTM D4814 in the U.S.A. and CGSB3.5-M93 in Canada.

■ Fuel tank opening for unleaded gasoline

To help prevent incorrect fueling, your Lexus has a fuel tank opening that only accommodates the special nozzle on unleaded fuel pumps.

■ If premium gasoline is not available

If 91 Octane cannot be obtained, you may use unleaded gasoline with an Octane Rating as low as 87 (Research Octane Number 91).

However, use of unleaded fuel with an Octane Rating lower than 91 may result in engine knocking or drastically reduce output to protect itself while driving with a heavy load. Persistent knocking can lead to engine damage and should be corrected by refueling with higher octane unleaded gasoline.

■ If your engine knocks

- Consult your Lexus dealer.
- You may occasionally notice light knocking for a short time while accelerating or driving uphill. This is normal and there is no need for concern.

■ Gasoline quality

In very few cases, driveability problems may be caused by the brand of gasoline you are using. If driveability problems persist, try changing the brand of gasoline. If this does not correct the problem, consult your Lexus dealer.

■ Gasoline quality standards

- Automotive manufacturers in the US, Europe and Japan have developed a specification for fuel quality called World-Wide Fuel Charter (WWFC) that is expected to be applied worldwide.
- The WWFC consists of four categories that are based on required emission levels. In the US, category 4 has been adopted.
- The WWFC improves air quality by lowering emissions in vehicle fleets, and customer satisfaction through better performance.

■ Lexus recommends the use of gasoline containing detergent additives

- Lexus recommends the use of gasoline that contains detergent additives to avoid build-up of engine deposits.
- All gasoline sold in the US contains detergent additives to clean and/or keep clean intake systems.

■ Lexus recommends the use of cleaner burning gasoline

Cleaner burning gasoline, including reformulated gasoline that contains oxygenates such as ethanol or MTBE (Methyl Tertiary Butyl Ether) is available in many areas.

Lexus recommends the use of cleaner burning gasoline and appropriately blended reformulated gasoline. These types of gasoline provide excellent vehicle performance, reduce vehicle emissions and improve air quality.

■ Lexus does not recommend blended gasoline

- Lexus allows the use of oxygenate blended gasoline where the oxygenate content is up to 10% ethanol or 15% MTBE.
- If you use gasohol in your Lexus, be sure that it has an octane rating no lower than 87.
- Lexus DOES NOT recommend the use of gasoline containing methanol.

■ Lexus does not recommend gasoline containing MMT

Some gasoline contains octane enhancing additive called MMT (Methylcy clopen-tadienyl Manganese Tricarbonyl).

Lexus DOES NOT recommend the use of gasoline that contains MMT. If fuel containing MMT is used, your emission control system may be adversely affected.

The malfunction indicator lamp on the instrument cluster may come on. If this happens, contact your Lexus dealer for service.

NOTICE

■ Notice on gasoline quality

- Do not use leaded gasoline.
Leaded gasoline can cause damage to your vehicle's three-way catalytic converters causing the emission control system to malfunction.
- Do not use gasohol other than that stated here.
Other gasohol may cause fuel system damage or vehicle performance problems.
- Using unleaded gasoline with an octane number or rating lower than that stated here will cause persistent heavy knocking. تلفن شبانه روزی: .
At worst, this will lead to engine damage.

■ Fuel-related poor driveability

If after using a different type of fuel, poor driveability is encountered (poor hot starting, vaporization, engine knocking, etc.), discontinue the use of that type of fuel.

■ When refueling with gasohol

Take care not to spill gasohol. It can damage your vehicle's paint.

6-1. Specifications

Tire information

Typical tire symbols



- 1 Tire size (→P. 559)
- 2 DOT and Tire Identification Number (TIN) (→P. 558)
- 3 Location of treadwear indicators (→P. 421)
- 4 Run-flat tire (RFT) or standard tire (→P. 522)

This vehicle can be equipped with either run-flat tires (RFT) or standard tires. A “RFT” or “DSST” mark is molded on the sidewall of the run-flat tire.

5 Tire ply composition and materials

Plies are layers of rubber-coated parallel cords. Cords are the strands which form the plies in a tire.

6 Radial tires or bias-ply tires

A radial tire has RADIAL on the sidewall. A tire not marked RADIAL is a bias-ply tire.

7 TUBELESS or TUBE TYPE

A tubeless tire does not have a tube and air is directly filled in the tire. A tube type tire has a tube inside the tire and the tube maintains the air pressure.

8 Load limit at maximum cold tire inflation pressure (→P. 562)**9** Maximum cold tire inflation pressure (→P. 562)

This means the pressure to which a tire may be inflated.

10 Uniform tire quality grading

For details, see "Uniform Tire Quality Grading" that follows.

11 Summer tire or all season tire (→P. 426)

An all season tire has "M+S" on the sidewall. A tire not marked "M+S" is a summer tire.

12 "TEMPORARY USE ONLY"

A compact spare tire is identified by the phrase "TEMPORARY USE ONLY" molded into its sidewall. This tire is designed for temporary emergency use only.

Typical DOT and tire identification number (TIN)

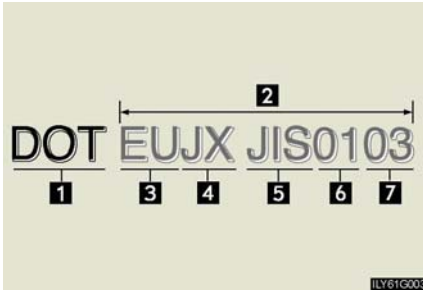

- 1 DOT symbol*
- 2 Tire Identification Number (TIN)
- 3 Tire manufacturer's identification mark
- 4 Tire size code
- 5 Manufacturer's optional tire type code (3 or 4 letters)
- 6 Manufacturing week
- 7 Manufacturing year

*: The DOT symbol certifies that the tire conforms to applicable Federal Motor Vehicle Safety Standards.

تلفن شبانه روزی: ۰۲۱-۸۸۶۲۰۸۵

FarmaSOS.com

Tire size

Typical tire size information

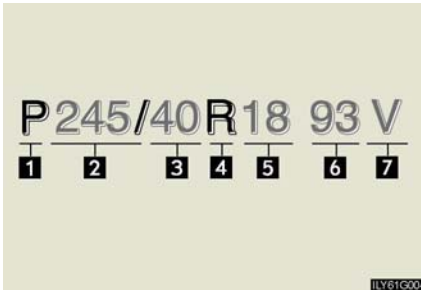

The illustration indicates typical tire size.

- 1 Tire use
(P = Passenger car,
T = Temporary use)
- 2 Section width (millimeters)
- 3 Aspect ratio
♦ (tire height to section width)
- 4 Tire construction code
(R = Radial, D = Diagonal)
- 5 Wheel diameter (inches)
- 6 Load index (2 or 3 digits)
- 7 Speed symbol
(alphabet with one letter)

Tire dimensions



- 1 Section width
- 2 Tire height
- 3 Wheel diameter

Tire section names

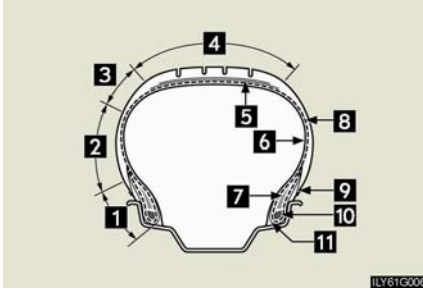

- 1 Bead
- 2 Sidewall
- 3 Shoulder
- 4 Tread
- 5 Belt
- 6 Inner liner
- 7 Reinforcing rubber
- 8 Carcass
- 9 Rim lines
- 10 Bead wires
- 11 Chaffer

Uniform Tire Quality Grading

This information has been prepared in accordance with regulations issued by the National Highway Traffic Safety Administration of the U.S.A. Department of Transportation.

It provides the purchasers and/or prospective purchasers of Lexus vehicles with information on uniform tire quality grading.

Your Lexus dealer will help answer any questions you may have as you read this information.

■ DOT quality grades

All passenger vehicle tires must conform to Federal Safety Requirements in addition to these grades. Quality grades can be found where applicable on the tire sidewall between tread shoulder and maximum section width.

For example: Treadwear 200 Traction AA Temperature A

■ Treadwear

The treadwear grade is a comparative rating based on the wear rate of the tire when tested under controlled conditions on a specified government test course.

For example, a tire graded 150 would wear one and a half (1 - 1/2) times as well on the government course as a tire graded 100.

The relative performance of tires depends upon the actual conditions of their use, however, and may depart significantly from the norm due to variations in driving habits, service practices and differences in road characteristics and climate.

■ Traction AA, A, B, C

The traction grades, from highest to lowest, are AA, A, B and C, and they represent the tire's ability to stop on wet pavement as measured under controlled conditions on specified government test surfaces of asphalt and concrete.

A tire marked C may have poor traction performance.

Warning: The traction grade assigned to this tire is based on braking (straight ahead) traction tests and does not include cornering (turning) traction.

■ Temperature A, B, C

The temperature grades are A (the highest), B, and C, representing the tire's resistance to the generation of heat and its ability to dissipate heat when tested under controlled conditions on a specified indoor laboratory test wheel.

Sustained high temperature can cause the material of the tire to degenerate and reduce tire life, and excessive temperature can lead to sudden tire failure.

The grade C corresponds to a level of performance which all passenger car tires must meet under the Federal Motor Vehicle Safety Standard No. 109.

Grades B and A represent higher levels of performance on the laboratory test wheel than the minimum required by law.

Warning: The temperature grades for this tire are established for a tire that is properly inflated and not overloaded.

Excessive speed, underinflation, or excessive loading, either separately or in combination, can cause heat buildup and possible tire failure.

Glossary of tire terminology

Tire related term	Meaning
Cold tire inflation pressure	Tire pressure when the vehicle has been parked for three hours or more, or has not been driven more than 1 mile or 1.5 km under that condition
Maximum inflation pressure	The maximum cold inflated pressure to which a tire may be inflated, shown on the sidewall of the tire
Recommended inflation pressure	Cold tire inflation pressure recommended by a manufacturer

Tire related term	Meaning
Accessory weight	The combined weight (in excess of those standard items which may be replaced) of automatic transmission, power steering, power brakes, power windows, power seats, radio and heater, to the extent that these items are available as factory-installed equipment (whether installed or not)
Curb weight	The weight of a motor vehicle with standard equipment, including the maximum capacity of fuel, oil and coolant, and if so equipped, air conditioning and additional weight optional engine
Maximum loaded vehicle weight	The sum of: (a) Curb weight (b) Accessory weight (c) Vehicle capacity weight (d) Production options weight
Normal occupant weight	150 lb. (68 kg) times the number of occupants specified in the second column of Table 1* that follows
Occupant distribution	Distribution of occupants in a vehicle as specified in the third column of Table 1* below
Production options weight	The combined weight of installed regular production options weighing over 5 lb. (2.3 kg) in excess of the standard items which they replace, not previously considered in curb weight or accessory weight, including heavy duty brakes, ride levelers, roof rack, heavy duty battery, and special trim
Rim	A metal support for a tire or a tire and tube assembly upon which the tire beads are seated
Rim diameter (Wheel diameter)	Nominal diameter of the bead seat

6-1. Specifications

Tire related term	Meaning
Rim size designation	Rim diameter and width
Rim type designation	The industry manufacturer's designation for a rim by style or code
Rim width	Nominal distance between rim flanges
Vehicle capacity weight (Total load capacity)	The rated cargo and luggage load plus 150 lb. (68 kg) times the vehicle's designated seating capacity
Vehicle maximum load on the tire	The load on an individual tire that is determined by distributing to each axle its share of the maximum loaded vehicle weight, and dividing by two
Vehicle normal load on the tire	The load on an individual tire that is determined by distributing to each axle its share of curb weight, accessory weight, and normal occupant weight (distributed in accordance with Table 1* below), and dividing it by two
Weather side	The surface area of the rim not covered by the inflated tire
Bead	The part of the tire that is made of steel wires, wrapped or reinforced by ply cords and that is shaped to fit the rim
Bead separation	A breakdown of the bond between components in the bead
Bias ply tire	A pneumatic tire in which the ply cords that extend to the beads are laid at alternate angles substantially less than 90 degrees to the centerline of the tread
Carcass	The tire structure, except tread and sidewall rubber which, when inflated, bears the load

Tire related term	Meaning
Chunking	The breaking away of pieces of the tread or sidewall
Cord	The strands forming the plies in the tire
Cord separation	The parting of cords from adjacent rubber compounds
Cracking	Any parting within the tread, sidewall, or innerliner of the tire extending to cord material
CT	A pneumatic tire with an inverted flange tire and rim system in which the rim is designed with rim flanges pointed radially inward and the tire is designed to fit on the underside of the rim in a manner that encloses the rim flanges inside the air cavity of the tire
Extra load tire	A tire designed to operate at higher loads and at higher inflation pressures than the corresponding standard tire
Groove	The space between two adjacent tread ribs
Innerliner	The layer(s) forming the inside surface of a tubeless tire that contains the inflating medium within the tire
Innerliner separation	The parting of the innerliner from cord material in the carcass
Intended outboard sidewall	<p>(a) The sidewall that contains a whitewall, bears white lettering, or bears manufacturer, brand, and/or model name molding that is higher or deeper than the same molding on the other sidewall of the tire, or</p> <p>(b) The outward facing sidewall of asymmetrical tire that has a particular side that must always face outward when mounted on a vehicle</p>

6-1. Specifications

Tire related term	Meaning
Light truck (LT) tire	A tire designated by its manufacturer as primarily intended for use on lightweight trucks or multipurpose passenger vehicles
Load rating	The maximum load that a tire is rated to carry for a given inflation pressure
Maximum load rating	The load rating for a tire at the maximum permissible inflation pressure for that tire
Maximum permissible inflation pressure	The maximum cold inflation pressure to which a tire may be inflated
Measuring rim	The rim on which a tire is fitted for physical dimension requirements
Open splice	Any parting at any junction of tread, sidewall, or innerliner that extends to cord material
Outer diameter	The overall diameter of an inflated new tire
Overall width	The linear distance between the exteriors of the sidewalls of an inflated tire, including elevations due to labeling, decorations, or protective bands or ribs
Passenger car tire	A tire intended for use on passenger cars, multipurpose passenger vehicles, and trucks, that have a gross vehicle weight rating (GVWR) of 10,000 lb. or less
Ply	A layer of rubber-coated parallel cords
Ply separation	A parting of rubber compound between adjacent plies

Tire related term	Meaning
Pneumatic tire	A mechanical device made of rubber, chemicals, fabric and steel or other materials, that, when mounted on an automotive wheel, provides the traction and contains the gas or fluid that sustains the load
Radial ply tire	A pneumatic tire in which the ply cords that extend to the beads are laid at substantially 90 degrees to the centerline of the tread
Reinforced tire	A tire designed to operate at higher loads and at higher inflation pressures than the corresponding standard tire
Section width	The linear distance between the exteriors of the sidewalls of an inflated tire, excluding elevations due to labeling, decoration, or protective bands
Sidewall	That portion of a tire between the tread and bead
Sidewall separation	The parting of the rubber compound from the cord material in the sidewall
Snow tire	A tire that attains a traction index equal to or greater than 110, compared to the ASTM E-1136 Standard Reference Test Tire, when using the snow traction test as described in ASTM F-1805-00, Standard Test Method for Single Wheel Driving Traction in a Straight Line on Snow-and Ice-Covered Surfaces, and which is marked with an Alpine Symbol () on at least one sidewall

Tire related term	Meaning
Test rim	The rim on which a tire is fitted for testing, and may be any rim listed as appropriate for use with that tire
Tread	That portion of a tire that comes into contact with the road
Tread rib	A tread section running circumferentially around a tire
Tread separation	Pulling away of the tread from the tire carcass
Treadwear indicators (TWI)	The projections within the principal grooves designed to give a visual indication of the degrees of wear of the tread
Wheel-holding fixture	The fixture used to hold the wheel and tire assembly securely during testing

*: Table 1 — Occupant loading and distribution for vehicle normal load for various designated seating capacities
 تلفن شبانه روزی: ۸۵

Designated seating capacity, Number of occupants	Vehicle normal load, Number of occupants	Occupant distribution in a normally loaded vehicle
2 through 4	2	2 in front
5 through 10	3	2 in front, 1 in second seat
11 through 15	5	2 in front, 1 in second seat, 1 in third seat, 1 in fourth seat
16 through 20	7	2 in front, 2 in second seat, 2 in third seat, 1 in fourth seat

6-2. Customization

Customizable features

Your vehicle includes a variety of electronic features that can be personalized to your preferences. Programming these preferences requires specialized equipment and may be performed by an authorized Lexus dealership.

Some function settings are changed simultaneously with other functions being customized. Contact your Lexus dealer for further details.

Item	Function	Default setting	Customized setting
Smart access system with push-button start (→P. 22)	Smart access system with push-button start	ON	OFF
	Operation signal (Emergency flashers)	ON	OFF
	Operation signal (Buzzer)	ON	OFF

FarmaSOS.com

Item	Function	Default setting	Customized setting
Wireless remote control (→P. 34)	Unlocking operation	Driver's door unlocked in 1-step, all doors unlocked in 2-step	All doors unlocked in 1-step
	Time elapsed before automatic door lock function is activated if door is not opened after being unlocked	60 seconds	OFF
			30 seconds
			120 seconds
	Operation signal (Emergency flashers)	ON	OFF
	Operation signal (Buzzer)	ON	OFF
	Trunk unlocking function	ON	OFF
	Trunk unlocking operation	Push and hold	Push twice
			One short push
Panic function	ON	OFF	
Buzzer sounds when pushing  with any door not closed	ON	OFF	

Item	Function	Default setting	Customized setting
Door lock (→P. 37)	Unlocking using a key	Driver's door unlocked in 1-step, all doors unlocked in 2-step	All doors unlocked in 1-step
	Speed-detecting automatic door lock function	OFF	ON
	Opening driver's door unlocks all doors	OFF	ON
	Shift the shift lever to "P" unlocks all doors	ON	OFF
	Shift the shift lever to position other than "P" locks all doors	ON	OFF
Power windows (→P. 64)	Linked door lock operation	ON	OFF
	Linked door key operation	Open and close	Open only
			Close only
	Wireless remote control linked operation	ON	OFF
Linked entry function	ON	OFF	

Item	Function	Default setting	Customized setting
Moon roof (→P. 67)	Linked door lock operation	ON	OFF
	Linked door key operation	Open and close	Open only
			Close only
	Linked operation of components when door key is used	Slide only	Tilt only
	Wireless remote control linked operation	ON	OFF
	Linked operation of components when wireless remote control used	Slide only	Tilt only
Linked entry function	ON	OFF	
Automatic light control system (→P. 142)	Light sensor sensitivity	Level 3	Levels 1 to 5
	Time elapsed before headlights automatically turn off after doors are closed	30 seconds	0 seconds
			60 seconds
			90 seconds
Daytime running light	ON	OFF*	

*: Vehicles sold outside Canada

Item	Function	Default setting	Customized setting
Windshield wipers and washer (→P. 146)	Switching operation when the vehicle is stationary	ON	OFF
	Drip prevention function	ON	OFF
	Time elapsed before the drip prevention function operates	Variable depending on the vehicle speed	3 seconds
Illumination (→P. 337)	Time elapsed before lights turn off	15 seconds	7.5 seconds
			30 seconds
	Operation when the doors are unlocked	ON	OFF
	Operation after the "ENGINE START STOP" switch turned OFF	ON	OFF
	Front/rear personal lights turned on when a door is opened	Corresponding light only	All lights
			OFF
	Foot lights	ON	OFF
	Shift lever light	ON	OFF
Outer foot light	ON	OFF	
Rear sunshade (→P. 357)	Time elapsed before the reverse operation feature activates	0.7 seconds	0 seconds
			0.9 seconds
			1.2 seconds

Multi-information display (→P.139)

Country	Available language
Canada	English and French

امداد خودرو فارما

تلفن شبانه روزی: ۰۲۱-۸۸۸۶۲۰۸۵

FarmaSOS.com

6-3. Initialization

Items to initialize

After reconnecting or performing maintenance on the 12 volt battery, the following items must be initialized for normal system operation.

Item	When to initialize	Reference
Intuitive parking assist	<ul style="list-style-type: none">• After reconnecting or changing the battery• After changing a fuse	P. 507
Engine oil maintenance data	<ul style="list-style-type: none">• After changing engine oil	P. 412
Tire pressure warning system	<ul style="list-style-type: none">• When rotating the tires on vehicles differing with front and rear tire inflation pressures.• When changing the tire inflation pressure by changing traveling speed or load weight, etc.• When changing the tire size.	P. 423

FarmaSOS.com

امداد خودرو فارما

تلفن شبانه روزی: ۰۲۱-۸۸۸۶۲۰۸۵

FarmaSOS.com

Reporting safety defects for U.S. owners	578
Seat belt instructions for Canadian owners (in French)	579

امداد خودرو فارما

تلفن شبانه روزی: ۰۲۱-۸۸۸۶۲۰۸۵

FarmaSOS.com

Reporting safety defects for U.S. owners

If you believe that your vehicle has a defect which could cause a crash or could cause injury or death, you should immediately inform the National Highway Traffic Safety Administration (NHTSA) in addition to notifying the Lexus Division of Toyota Motor Sales, U.S.A., Inc. (Toll-free: 1-800-25-LEXUS).

If NHTSA receives similar complaints, it may open an investigation, and if it finds that a safety defect exists in a group of vehicles, it may order a recall and remedy campaign. However, NHTSA cannot become involved in individual problems between you, your dealer, or the Lexus Division of Toyota Motor Sales, U.S.A., Inc.

To contact NHTSA, you may call the Vehicle Safety Hotline toll-free at 1-888-327-4236 (TTY: 1-800-424-9153); go to <http://www.safercar.gov>; or write to: Administrator, NHTSA, 1200 New Jersey Ave, S.E., Washington, DC 20590. You can also obtain other information about motor vehicle safety from <http://www.safercar.gov>.

تلفن شبانه روزی: ۰۲۱-۸۸۶۲۰۸۵

FarmaSOS.com

Seat belt instructions for Canadian owners (in French)

The following is a French explanation of seat belt instructions extracted from the seat belt section in this manual.

See the seat belt section for more detailed seat belt instructions in English.

Utilisation adéquate des ceintures de sécurité

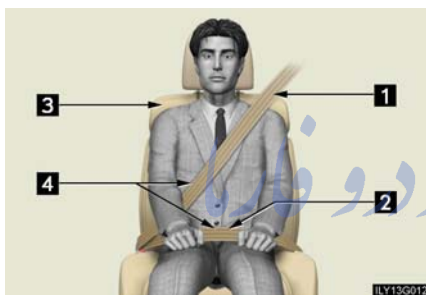

- 1 Tirez sur la ceinture épaulière jusqu'à ce qu'elle recouvre entièrement l'épaule; elle ne doit cependant pas toucher le cou ni glisser de l'épaule.
- 2 Placez la ceinture abdominale le plus bas possible sur les hanches.
- 3 Réglez la position du dossier du siège. Tenez-vous assis dans le fond du siège, le dos droit.
- 4 Ne vrillez pas la ceinture de sécurité.

Guide des ceintures de sécurité (sièges latéraux arrière)

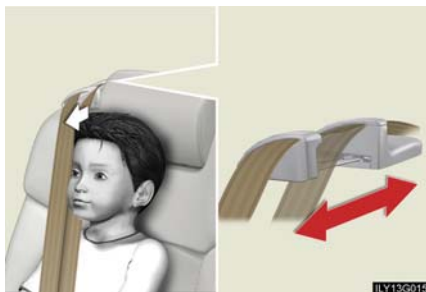

Si la ceinture épaulière est trop près du cou d'une personne, glissez le guide de la ceinture vers l'avant.

Entretien et soin

■ Ceintures de sécurité

Avec un tissu ou une éponge, nettoyez à l'aide d'un savon doux et de l'eau tiède. Vérifiez aussi les ceintures régulièrement pour vous assurer qu'elles ne présentent pas d'usure excessive, d'effilochage ou de coupures.

ATTENTION

■ Dommages et usure de la ceinture de sécurité

Vérifiez périodiquement le système de ceintures de sécurité. Assurez-vous qu'il n'y a pas de coupures, d'effilochures ni de pièces desserrées. N'utilisez pas une ceinture de sécurité endommagée avant qu'elle soit remplacée. Les ceintures de sécurité endommagées ne peuvent pas protéger les occupants contre les blessures.

تلفن شبانه روزی: ۰۲۱-۸۸۶۲۰۸۵

FarmaSOS.com

Index

Abbreviation list 582

Alphabetical index 584

What to do if... 594

اهداء خود رو فارما

تلفون: ۰۲۱-۸۸۸۲۲۰۸۵

FarmaSOS.com

Abbreviation list

Abbreviation/Acronym list

ABBREVIATIONS	MEANING
A/C	Air Conditioning
ABS	Anti-Lock Brake System
AFS	Adaptive Front-lighting System
ALR	Automatic Locking Retractor
CRS	Child Restraint System
DISP	Display
ECU	Electronic Control Unit
EDR	Event Data Recorder
ELR	Emergency Locking Retractor
EPS	Electric Power Steering
GAWR	Gross Axle Weight Ratings
GPS	Global Positioning System
I/M	Emission inspection and maintenance
INFO	Information
INT	Intermittent
LED	Light Emitting Diode
MMT	Methylcy clopentadienyl Manganese Tricarbonyl
M + S	Mud and Snow
MTBE	Methyl Tertiary Butyl Ether
OBD	On Board Diagnostics

ABBREVIATIONS	MEANING
PCS	Pre-Collision System
SRS	Supplemental Restraint System
TIN	Tire Identification Number
TPMS	Tire Pressure Monitoring (Warning) System
TRAC	Traction Control
VDIM	Vehicle Dynamics Integrated Management
VGRS	Variable Gear Ratio Steering
VIN	Vehicle Identification Number
VSC	Vehicle Stability Control

امداد خودرو فارما

تلفن شبانه روزی: ۰۲۱-۸۸۶۲۰۸۵

FarmaSOS.com

A	A/C	217
	ABS.....	184
	ACCESSORY mode	122
	Active stabilizer suspension system.....	184
	Adaptive variable suspension system	183
	Air conditioning system Air conditioning filter	437
	Automatic air conditioning system.....	217
	Airbags Airbag operating conditions.....	83
	Airbag precautions for your child.....	87
	Airbag warning light	489
	Curtain shield airbag precautions	90
	General airbag precautions.....	87
	Locations of airbags.....	80
	Modification and disposal of airbags.....	91
	Proper driving posture	78
	Side airbag precautions.....	87
	Side and curtain shield airbags operating conditions	83
	SRS airbags	80
	Alarm	75
	Antenna	235
	Anti-lock brake system	184
	Armrest.....	356
	Ashtrays.....	351

Audio system Antenna.....	235
AUX adapter	287
Cassette player	238
CD player/changer	242
DVD information	270
DVD player/changer	251
DVD video/audio.....	254
MP3/WMA disc.....	247
Optimal use	282
Radio	229
Steering switches	288
Video CD	266
Automatic headlight leveling system	144
Automatic light control system.....	142
Automatic transmission If the shift lever cannot be shifted from "P"	524
Mode select switch	126
S mode.....	127
AUX adapter.....	287
B	
Back-up lights Wattage.....	552
Battery 12 volt battery	417
Checking.....	417
If the 12 volt battery is discharged	529
Preparing and checking before winter.....	199
Bluetooth®	296

Brake	
Fluid.....	416
Parking brake.....	131
Brake assist.....	184

C

Care	
Exterior.....	388
Interior.....	391
Seat belts.....	392
Cargo capacity.....	194
Cargo hooks.....	360
CD player/changer.....	242
Chains.....	200
Child-protectors.....	38
Child restraint system	
Definition.....	98
Installation.....	102
Installing CRS with lower anchors.....	106
Installing CRS with seatbelts.....	103
Installing CRS with top straps.....	107
Child safety	

Airbag precautions.....	87
Battery precautions.....	419, 532
Child restraint system.....	98
Child-protectors.....	38
How your child should wear the seatbelt.....	56
Installing child restraints.....	102
Moon roof precautions.....	69
Power window lock switch.....	64
Power window precautions.....	64
Removed electronic key battery precautions.....	441
Seat belt comfort guide.....	54
Seat belt precautions.....	57

Seat heater precautions.....	355
Trunk precautions.....	44
Cigarette lighter.....	352
Cleaning	
Exterior.....	388
Interior.....	391
Seat belts.....	392
Clock.....	349
Coin holder.....	345
Compass.....	369
Condenser.....	415
Console box.....	342
Cooling system	
Engine overheating.....	533
Cruise control	
Cruise control.....	150
Dynamic radar cruise control.....	153
Cup holders.....	345
Curtain shield airbags.....	80
Customizable features.....	569

D

Daytime running light system.....	143
Defogger	
Rear window.....	225
Side mirror.....	225
Dimension.....	540
Dinghy towing.....	205
Display	
Multi-information display.....	139
Touch screen.....	208
Trip information.....	140
Warning message.....	497
Do-it-yourself maintenance.....	400
Door courtesy lights.....	337
Door pocket.....	346

Doors

- Door lock..... 22, 34, 37
- Rear door child protector38

Driver's seat belt reminder light490

Driver's seat position memory 47

Driving

- Correct posture 78
- Procedures112

DVD player/changer..... 251

E

Electric power steering 184

Electronic key

- If the electronic key does not operate properly..... 526
- Replacing battery440

Emergency, in case of

- If a warning light turns on 488
- If a warning message is displayed497
- If the electronic key does not operate properly..... 526
- If the engine will not start..... 523
- If the shift lever cannot be shifted from "P" 524
- If the 12 volt battery is discharged 529
- If you have a flat tire 512, 522
- If you lose your keys..... 525
- If you think something is wrong.....484
- If your vehicle becomes stuck.....536
- If your vehicle needs to be towed 478
- If your vehicle overheats.....533

Engine

- ACCESSORY mode.....122
- Compartment 406
- Engine (ignition) switch..... 121
- Hood 403
- How to start the engine 121
- If the engine will not start..... 523
- Overheating 533

Engine compartment cover408

Engine coolant temperature

- gauge132

Engine coolant

- Capacity 546
- Checking..... 414
- Preparing and checking before winter.....199

Engine oil

- Capacity 544
- Checking..... 409
- Preparing and checking before winter.....199

Engine oil maintenance data 412

Engine (ignition) switch..... 121

Event data recorder 486

F

First-aid kit storage belt 360

Floor mats 359

Fluid

- Brake 416
- Washer..... 420

Fog lights

- Switch..... 145
- Wattage 552

Foot light 337

Front passenger occupant classification system	92
Front passenger's seat belt reminder light	490
Front seats	
Adjustment	45
Driver's seat position memory	47
Front turn signal lights	
Wattage	552
Fuel	
Capacity	543
Fuel gauge	132
Gas station information	596
Information	553
Refueling	70
Fuel door	70
Fuel filler door	70
Fuses	442

G Garage door opener	363
Gas station information	596
Gauges	132
Glove box	341

H Hands-free system (for cellular phone)	291
Head restraints	51
Headlight aim	467
Headlight cleaner	149

Headlights	
Adaptive front lighting system	143
Discharge headlights	
precautions	475
Replacing light bulbs	470
Switch	142
Wattage	552

Heaters	
Seat heaters	354
Side mirror	225

Hill-start assist control	184
Hood	403

Hooks	
Cargo	360
Shopping bag	360

I Identification	
Engine	542
Vehicle	541

Ignition switch	
Engine switch	121
Illuminated entry system	337
I/M test	399

Immobilizer system	73
Indicator lights	136

Initialization	
Items to initialize	575

Inside rear view mirror	61
Instrument panel light control	133

Interior lights	
Interior lights	338
Wattage	552

Intuitive parking assist	164
--------------------------------	-----

J	Jack	
	Positioning a floor jack.....	404
	Replacing the wheel.....	512
	Jack handle.....	512

K	Keyless entry.....	34
	Keys	
	Engine (ignition) switch.....	121
	If the electronic key does not operate properly.....	526
	If you lose your keys.....	525
	Key number plate.....	20
	Keys.....	20
	Mechanical key.....	20
	Wireless remote control key.....	34

L	Lexus Link System.....	373
	Light bulbs	
	Replacing.....	470
	Wattage.....	552
	Light sensitive optitron meter.....	134
	Lights	
	Fog light switch.....	145
	Headlights switch.....	142
	Interior lights list.....	337
	Replacing light bulbs.....	470
	Turn signal lever.....	130
	Vanity lights.....	348
	Wattage.....	552

M	Maintenance	
	Do-it-yourself maintenance.....	400
	General maintenance.....	396
	Maintenance data.....	540
	Maintenance requirements.....	394

	Meter	
	Instrument panel light control.....	133
	Meters.....	132

	Micro dust and pollen filter.....	221
--	-----------------------------------	-----

	Mirrors	
	Inside rear view mirror.....	61
	Side mirror heater.....	225
	Side mirrors.....	62
	Vanity mirrors.....	348

	Moon roof.....	67
--	----------------	----

	MP3 disc.....	247
--	---------------	-----

	Multi-information display.....	139
--	--------------------------------	-----

O	Odometer.....	132
----------	---------------	-----

	Oil	
	Engine oil.....	409
	Opener	
	Fuel filler door.....	70
	Hood.....	403
	Trunk.....	42

	Outer foot lights.....	337
--	------------------------	-----

	Outside rear view mirrors	
	Adjusting and folding.....	62
	Mirror position memory.....	47

	Outside temperature display.....	140, 350
--	-------------------------------------	----------

	Overhead console.....	343
--	-----------------------	-----

	Overheating, Engine.....	533
--	--------------------------	-----

P

Parking brake 131

Parking lights

 Replacing light bulbs 470

 Switch 142

 Wattage 552

Personal lights 339

Power outlet 353

Power windows 64

Pre-collision system 190

R

Radar cruise control 153

Radiator 415

Radio 229

Radio data system 231

Rear sunshade 357

Rear turn signal lights

 Replacing light bulbs 470

 Wattage 552

Rear view monitor system 179

Rear window defogger 225

Replacing

 Electronic key battery 440

 Fuses 442

 Light bulbs 470

Reporting safety defects for

 U.S. owners 578

S

Seat belts

 Adjusting the seat belt 53

 Automatic locking retractor 55

 Child restraint system

 installation 102

 Cleaning and maintaining

 the seat belts 392

 Emergency locking retractor 55

 How to wear your seat belt 53

 How your child should wear

 the seat belt 56

 Pre-collision seat belts 55

 Pregnant women,

 proper seat belt use 55

 Reminder light 490

 Seat belt extenders 56

 Seat belt pretensioners 54

Seat heaters/ventilators 355

Seating capacity 198

Seats

 Adjustment 45

 Adjustment precautions 46

 Child seats/child restraint

 system installation 102

 Cleaning 391

 Driver's seat position memory 47

 Head restraint 51

 Properly sitting in the seat 78

 Seat heaters 354

Service reminder indicators 136

Shift lever

 Automatic transmission 125

 If the shift lever cannot be

 shifted from "P" 524

Shift lock system 524

Shopping bag hooks 360

Side airbags 80

Side marker lights

 Switch 142

Side mirror

 Adjusting and folding 62

 Mirror position memory 47

Smart access system with
 push-button start
 Antenna location.....24
 Entry function.....22
 Starting the engine.....121

Spare tire
 Inflation pressure.....550
 Spare tire.....513

Spark plug.....546

Specifications540

Speedometer.....132

Steering wheel
 Adjustment.....60
 Audio switches288
 Steering wheel position
 memory.....47

Storage compartment344

Storage feature.....340

Stuck
 If your vehicle becomes stuck.....536

Sun visors347

Switch
 “ENGINE START STOP”
 switch121
 Fog light switch.....145
 Ignition switch.....121
 Light switches.....142
 Mode select switch.....126
 Power door lock switch.....37
 Power window switch.....64
 Tire pressure warning
 reset switch422
 Tire pressure
 warning select switch.....424
 Window lock switch64
 Wipers and washer switch.....146

T Tachometer132

Tail lights
 Switch.....142

Theft deterrent system
 Alarm.....75
 Immobilizer system73

Theft prevention labels.....77

Tire inflation pressure550

Tire information
 Glossary562
 Size.....559
 Tire identification number.....558
 Uniform Tire Quality Grading...560

Tires
 Chains.....200
 Checking.....421
 Compact spare tire.....513
 If you have a flat tire512, 522
 Inflation pressure550
 Information556
 Replacing512
 Rotating tires.....421
 Size.....550
 Snow tires.....202
 Tire pressure warning system.....421

Tools.....512

Total load capacity198

Touch screen.....208

Towing
 Dinghy towing205
 Emergency towing.....478
 Trailer towing204

Traction control.....184

Trip meter132

Trunk	
Opener.....	42
Trunk light.....	43
Wattage.....	552
Turn signal lights	
Replacing light bulbs.....	470
Switch.....	130
Wattage.....	552

V

Vanity lights	
Vanity lights.....	348
Wattage.....	552
Vanity mirrors.....	348
Variable gear ratio steering.....	185
Vehicle dynamics	
integrated management.....	185
Vehicle identification number.....	541
Vehicle load limits.....	198
Vehicle stability control.....	184
Ventilators.....	354

W

Warning buzzers	
Brake system.....	488
Downshifting.....	128
Open door.....	490
Seat belt reminder.....	490
Warning lights	
Anti-lock brake system.....	489
Brake system.....	488
Charging system.....	488
Electric power steering	
warning light.....	489
Electronically	
controlled brake system/	
Vehicle stability control.....	489
Low fuel level.....	490

Malfunction indicator lamp.....	489
Master warning light.....	491
Open door.....	490
Pre-collision system.....	489
Seat belt reminder light.....	490
SRS airbags.....	489
Tire pressure warning light.....	490

Warning messages

Anti-lock brake system.....	501
Brake assist.....	501
Dynamic radar	
cruise control.....	500
Engine oil level.....	504
Engine oil maintenance.....	504
Engine oil pressure.....	497
Headlight.....	498
Hill-start assist control.....	501
Hood.....	502
Intuitive parking	
assist.....	499, 505, 507
Moon roof.....	503
Open door.....	502
Parking brake.....	503
Pre-collision system.....	499, 505
Rear lights system.....	498
Smart access system with	
push-button start.....	508
Steering lock.....	498, 510
Tire pressure warning	
system.....	498, 504
TRAC.....	501
Trunk.....	503
VGRS.....	501
VSC/ECB.....	501
Washer fluid.....	503

Washer	
Checking	420
Preparing and checking before winter	199
Switch	146
Washing and waxing.....	388
Weight	
Cargo capacity.....	194
Load limits	198
Weight	540
Wheels	435
Window glasses	37
Window lock switch	37
Windows	
Power windows.....	64
Rear window defogger	225
Washer	146
Windshield wipers	
Position	201
Windshield wipers	146
Winter driving tips	199
Wireless remote control key	
Locking/Unlocking	34
Replacing the battery	440
WMA disc	247

امداد خودرو فارسی

تلفن شبانه روزی: ۰۲۱-۸۸۴۲۰۸۵

FormaSOS.com

امداد خودرو فارما

تلفن شبانه روزی: ۰۲۱-۸۸۸۶۲۰۸۵

FarmaSOS.com

What to do if...

What to do if...



A tire punctures

P. 512/
522

If you have a flat tire



The engine does not start

P. 73

Immobilizer system

P. 523

If the engine will not start

P. 529

If the 12 volt battery is discharged



The shift lever cannot be moved out

P. 524

If the shift lever cannot be shifted from "P"



The engine coolant temperature gauge enters the red zone

P. 533

If your vehicle overheats



Steam can be seen coming from under the hood

تلفن شبانه روزی: ۰۲۱-۸۸۶۲۰۸۵



The key is lost

P. 525

If you lose your keys

FarmaSOS.com



The battery runs out

P. 529

If the 12 volt battery is discharged



The doors cannot be locked

P. 37

Doors



The horn begins to sound

P. 75

Alarm



The vehicle is stuck in mud or sand

P. 536

If the vehicle becomes stuck

 The warning light or indicator light comes on

P. 488 If the warning light turns on



■ Warning lights



Brake system warning light



P. 488



Malfunction indicator lamp



P. 489



ABS warning light



P. 489



Driver's seat belt reminder light

P. 490



Front passenger's seat belt reminder light

P. 490



ECB*/VSC warning light

P. 489



Tire pressure warning light

P. 490



Low fuel level warning light

P. 490



Electric power steering warning light

P. 489



SRS warning light

P. 489



Pre-collision system warning light

P. 489



Open door warning light

P. 490



Master warning light

P. 491



Charging system warning light

P. 488

*: Electronically Controlled Brake System

 The warning message is displayed

P. 497 If the warning message is displayed

GAS STATION INFORMATION

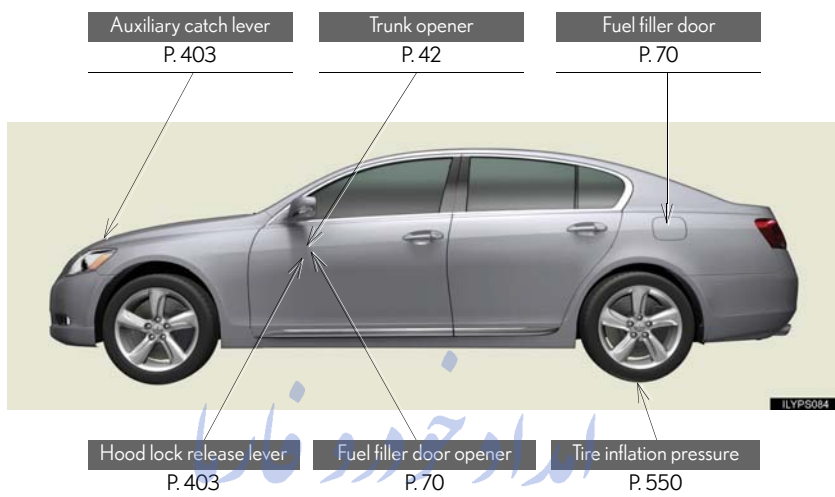

Fuel tank capacity	18.7 gal. (71 L, 15.6 Imp.gal.)		
Fuel type	Premium unleaded gasoline only		P. 71, 543
Cold tire inflation pressure	P. 550		
Engine oil capacity (Drain and refill)			qt. (L, Imp.qt.)
With filter	GS460	GS350 (2WD)	GS350 (4WD)
Without filter	9.1 (8.6, 7.6)	6.6 (6.3, 5.5)	6.7 (6.4, 5.6)
	8.9 (8.4, 7.4)	6.2 (5.9, 5.2)	6.3 (6.0, 5.3)
Engine oil type	"Toyota Genuine Motor Oil" or equivalent Oil grade: ILSAC multigrade engine oil		P. 544